

LH351Z – 3535 Ceramic LED @85°C

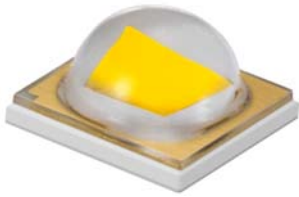

Introduction

Features

- Package : Ceramic Substrate LED Package
- View Angle: 115 °
- Precondition : JEDEC Level 2a
- Dimension : 3.5 x 3.5 x 1.9 mm
- ESD withstand Voltage : up to ± 5 kV [HBM]
- Reliability Test : IES-LM-80-08 qualified(TBD)

Applications

- INDOOR LIGHTING : Spot light, Down light
- OUTDOOR LIGHTING : Street light, Security light, Tunnel light, Parking lots light
- INDUSTRIAL LIGHTING : High-bay light, Low-bay light
- CONSUMER LIGHTING : Torch light

SAMSUNG ELECTRONICS

95, Samsung2-Ro, Giheung-Gu,
Yongin-City, Gyeonggi-Do 446-711, KOREA

Contents

1. Luminous Flux Characteristics	-----	3
2. Characteristics	-----	4
3. Typical Characteristics Graph	-----	5
4. Outline Drawing & Dimension	-----	11
5. Reliability Test Items and Conditions	-----	12
6. Solder Conditions	-----	13
7. Tape & Reel	-----	14
8. Label Structure	-----	15
9. Packing Structure	-----	16
10. Precaution For Use	-----	18
11. Hazard Substance Analysis	-----	20
12. Revision History	-----	27

1. Luminous Flux Characteristics (T_j = 85°C)

Nominal CCT	Minimum CRI ⁽¹⁾	Sorting condition Im ² @350mA		Calculated Minimum Im ³		Product Code	BIN Structure
		Rank	Min Im ²	@700mA	@1000mA		
2700K	80	F3 (G2)	90 (100)	158 (175)	203 (226)	SPHWHTL3D20EE3W0F3	Whole
						SPHWHTL3D20EE3WPF3	Quarter
						SPHWHTL3D20EE3WMF3	M3
		G3 (H3)	100 (110)	175 (193)	226 (249)	SPHWHTL3D20EE3W0G3	Whole
						SPHWHTL3D20EE3WPG3	Quarter
						SPHWHTL3D20EE3WMG3	M3
3000K	80	F3 (G3)	90 (100)	158 (175)	203 (226)	SPHWHTL3D20EE3V0F3	Whole
						SPHWHTL3D20EE3VPF3	Quarter
						SPHWHTL3D20EE3VMF3	M3
		G3 (H3)	100 (110)	175 (193)	226 (249)	SPHWHTL3D20EE3V0G3	Whole
						SPHWHTL3D20EE3VPG3	Quarter
						SPHWHTL3D20EE3VMG3	M3
		H3 (J3)	110 (120)	193 (210)	249 (271)	SPHWHTL3D20EE3V0H3	Whole
						SPHWHTL3D20EE3VPH3	Quarter
						SPHWHTL3D20EE3VMH3	M3
3500K	80	G3 (H3)	100 (110)	175 (193)	226 (249)	SPHWHTL3D20EE3U0G3	Whole
						SPHWHTL3D20EE3UPG3	Quarter
						SPHWHTL3D20EE3UMG3	M3
		H3 (J3)	110 (120)	193 (210)	249 (271)	SPHWHTL3D20EE3U0H3	Whole
						SPHWHTL3D20EE3UPH3	Quarter
						SPHWHTL3D20EE3UMH3	M3
4000K	80	G3 (H3)	100 (110)	175 (193)	226 (249)	SPHWHTL3D20EE3T0G3	Whole
						SPHWHTL3D20EE3TPG3	Quarter
						SPHWHTL3D20EE3TMG3	M3
		H3 (J3)	110 (120)	193 (210)	249 (271)	SPHWHTL3D20EE3T0H3	Whole
						SPHWHTL3D20EE3TPH3	Quarter
						SPHWHTL3D20EE3TMH3	M3
4000K	70	H3 (J3)	110 (120)	193 (210)	249 (271)	SPHWHTL3D20CE3T0H3	Whole
						SPHWHTL3D20CE3TPH3	Quarter
						SPHWHTL3D20CE3TMH3	M3
		J3 (K3)	120 (130)	210 (228)	271 (294)	SPHWHTL3D20CE3T0J3	Whole
						SPHWHTL3D20CE3TPJ3	Quarter
						SPHWHTL3D20CE3TMJ3	M3



		K3	130	228	294	SPHWHTL3D20CE3T0K3	Whole		
		(M3)	(140)	(245)	(316)	SPHWHTL3D20CE3TPK3	Quarter		
						SPHWHTL3D20CE3TMK3	M3		
5000K	75	H3	110	193	249	SPHWHTL3D20DE3RTH3	M7		
		(J3)	(120)	(210)	(271)				
	70	J3	120	210	271	SPHWHTL3D20DE3RTJ3	M7		
		(K3)	(130)	(228)	(294)				
		H3	110	193	249			SPHWHTL3D20CE3RTH3	M7
		(J3)	(120)	(210)	(271)				
70	J3	120	210	271	SPHWHTL3D20CE3RTJ3	M7			
	(K3)	(130)	(228)	(294)					
5700K	75	H3	110	193	249	SPHWHTL3D20DE3QTH3	M7		
		(J3)	(120)	(210)	(271)				
	70	H3	110	193	249	SPHWHTL3D20CE3QTH3	M7		
		(J3)	(120)	(210)	(271)				
		J3	120	210	271			SPHWHTL3D20CE3QTJ3	M7
		(K3)	(130)	(228)	(294)				
70	K3	130	228	294	SPHWHTL3D20CE3QTK3	M7			
	(M3)	(140)	(245)	(316)					
6500K	70	H3	110	193	249	SPHWHTL3D20CE3PTH3	M7		
		(J3)	(120)	(210)	(271)				
		J3	120	210	271			SPHWHTL3D20CE3PTJ3	M7
(K3)	(130)	(228)	(294)						

()* : Minimum luminous flux @ 25°C

Notes:

- 1) SAMSUNG ELECTRONICS maintains a tolerance of ± 3.0 on CRI measurements.
- 2) SAMSUNG ELECTRONICS maintains a tolerance of $\pm 7\%$ on flux measurements.
- 3) Calculated flux values are for reference only.

2. Characteristics

1) Electro-optical Characteristics

Item	Unit	Min	Typ	Max
Forward voltage ¹⁾ (@350 mA, T _j = 85°C)	V	2.7	2.9	3.0
Forward voltage ¹⁾ (@700 mA, T _j = 85°C)	V		3.1	
Forward voltage ¹⁾ (@1000 mA, T _j = 85°C)	V		3.2	
Operation forward current (T _j = 85°C)	mA	-	-	1000
Thermal resistance R _{th,j-s}	°C/W	-	7	
LED junction temperature T _j	°C	-	-	150
Operating temperature range T _{opr}	°C	-40	-	85
Storage temperature range T _{stg}	°C	-40	-	120
Viewing Angle	°	-	115	-

Item	Unit	3000K	5000K
Forward voltage ¹⁾ (@350 mA, T _j = 25°C)	V	3.0	
Forward voltage ¹⁾ (@350 mA, T _j = 85°C)	V	2.9	
Luminous flux ²⁾ (@350 mA, T _j = 25°C)	lm	110	143
Luminous flux (@350 mA, T _j = 85°C)	lm	100	130
Luminous flux (@700 mA, T _j = 85°C)	lm	175	228
Luminous flux (@1000 mA, T _j = 85°C)	lm	226	293

Notes:

- 1) SAMSUNG ELECTRONICS maintains a tolerance of ±0.1V on forward voltage measurements.
- 2) Characteristics @ 25°C are for reference only.

2) Vf Rank (T_j = 85°C)

Parameter	Symbol	Condition	Rank	Rank	Min.	Typ.	Max.
Forward Voltage	V _F	I _F = 350mA	E3		2.7	-	3.0

3. Typical Characteristics Graph

1) Spectrum Distribution

($T_j = 85^\circ\text{C}$)

2700K & 3000K

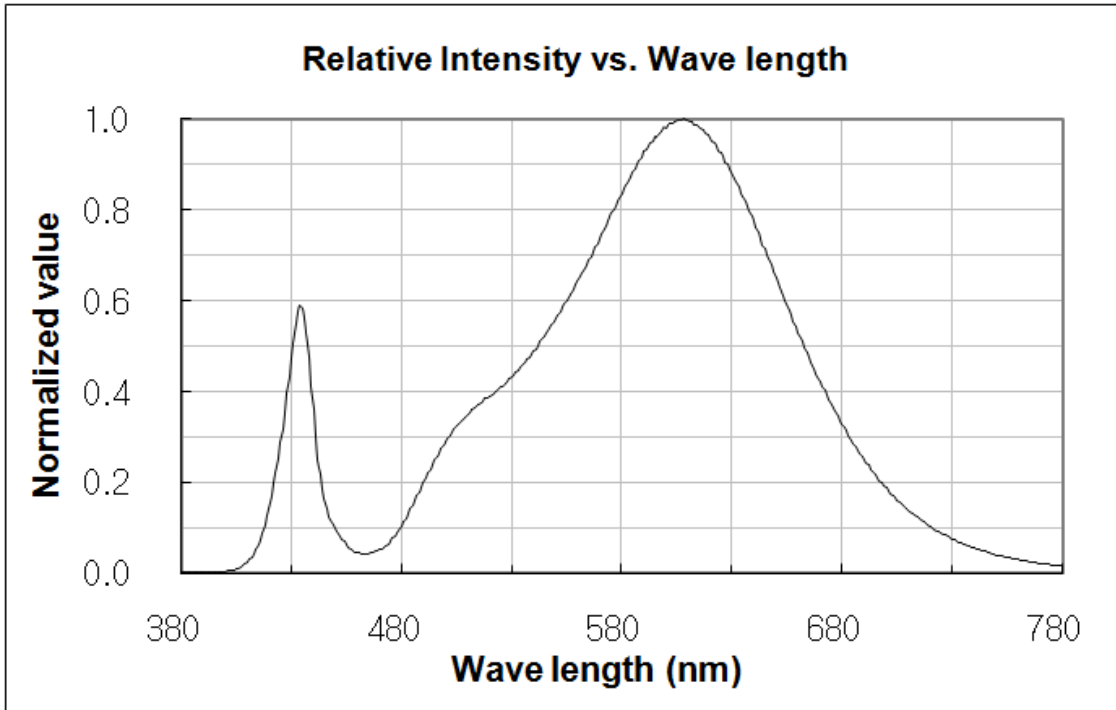

3500K & 4000K

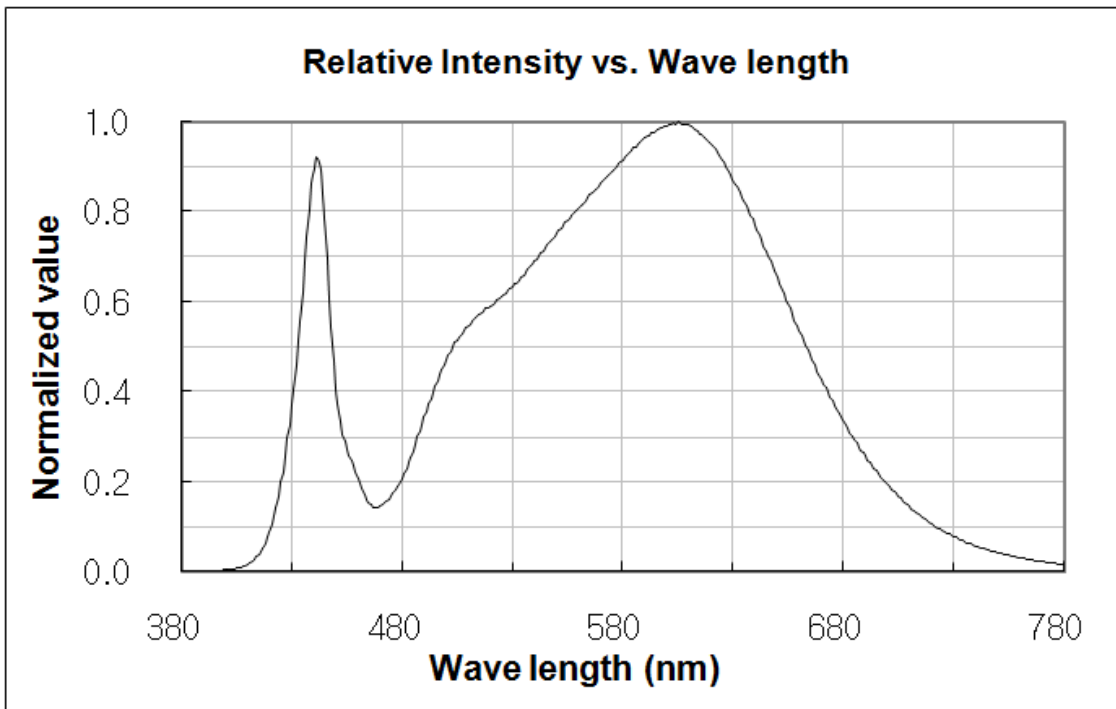

5000K

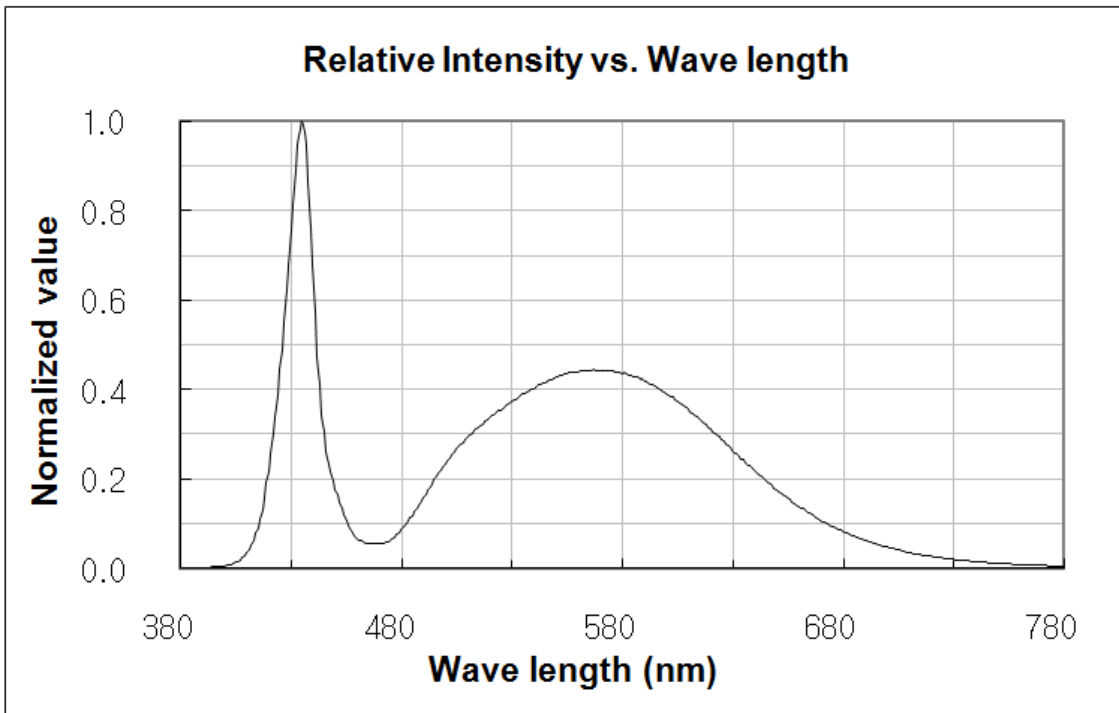

5700K & 6500K

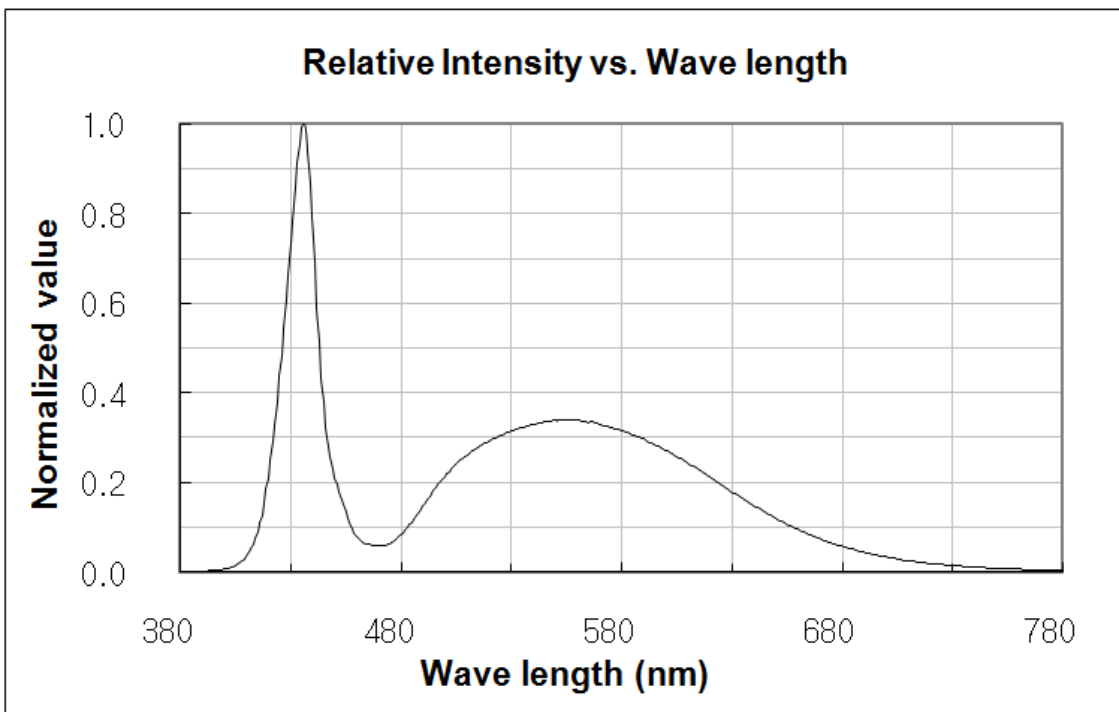

2) Forward Current Characteristics

($T_j = 85^\circ\text{C}$)

Relative Flux vs. Forward Current

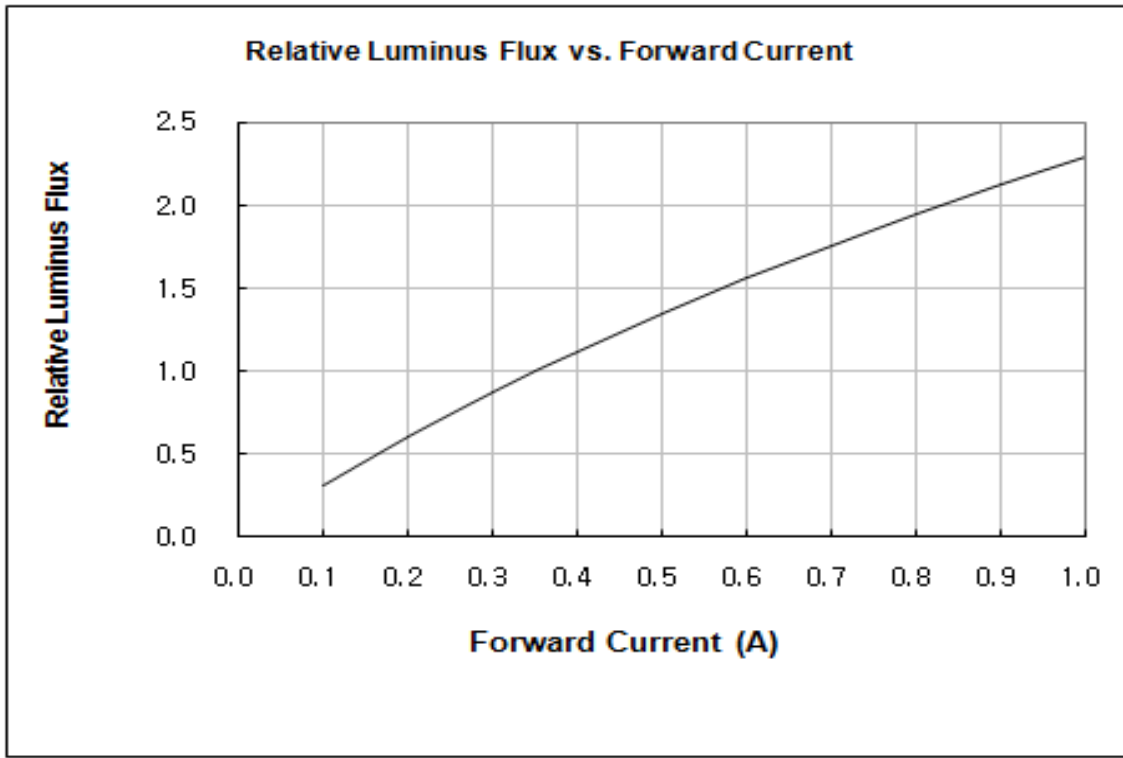

Forward Current vs. Forward Voltage

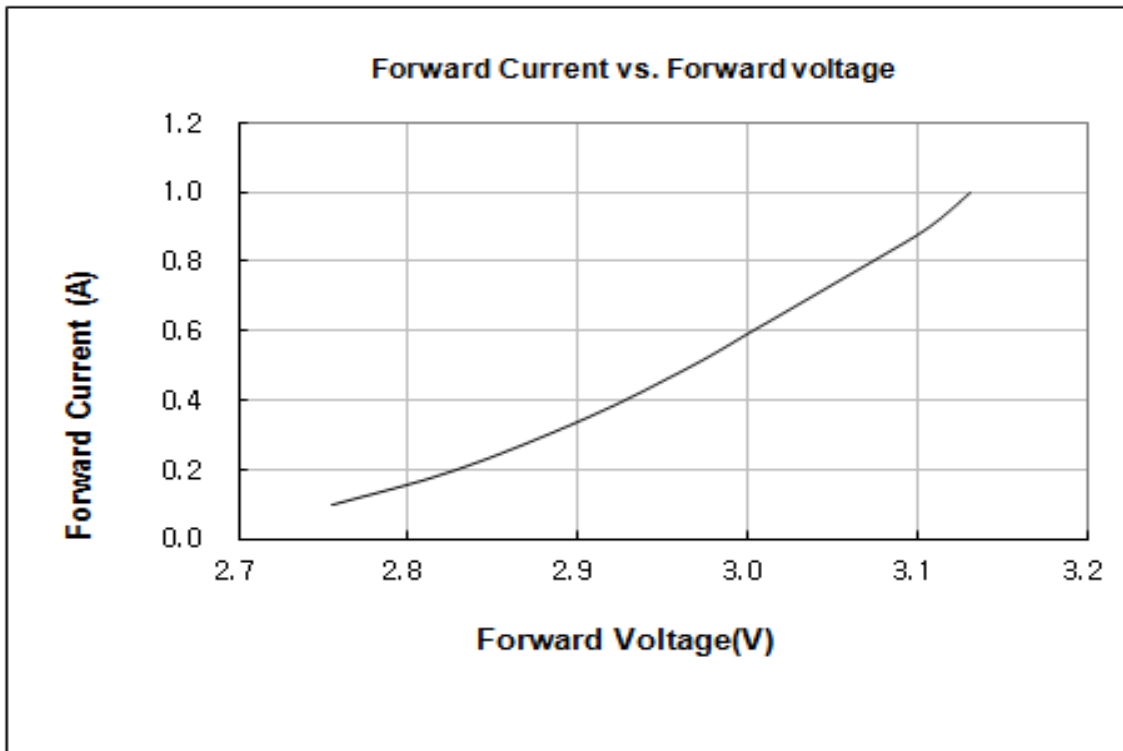

3) Temperature Characteristics

Relative Flux vs. Junction Temperature ($I_F = 350\text{mA}$)

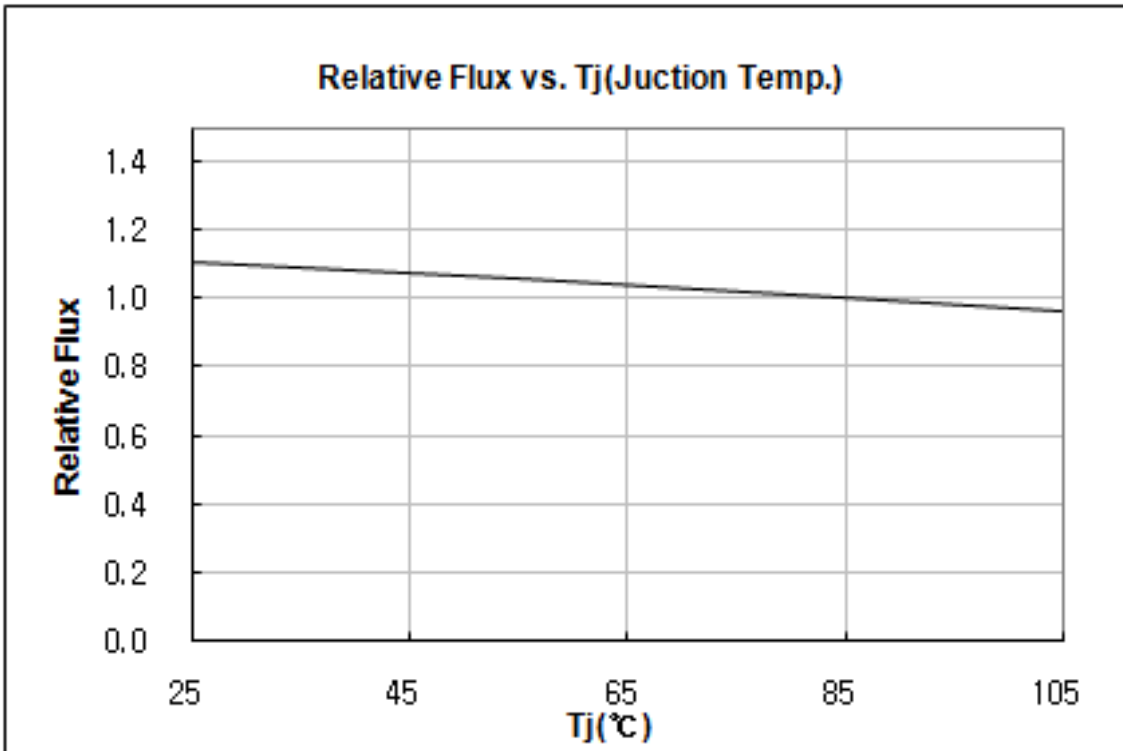

Forward Voltage vs. Junction Temperature ($I_F = 350\text{mA}$)

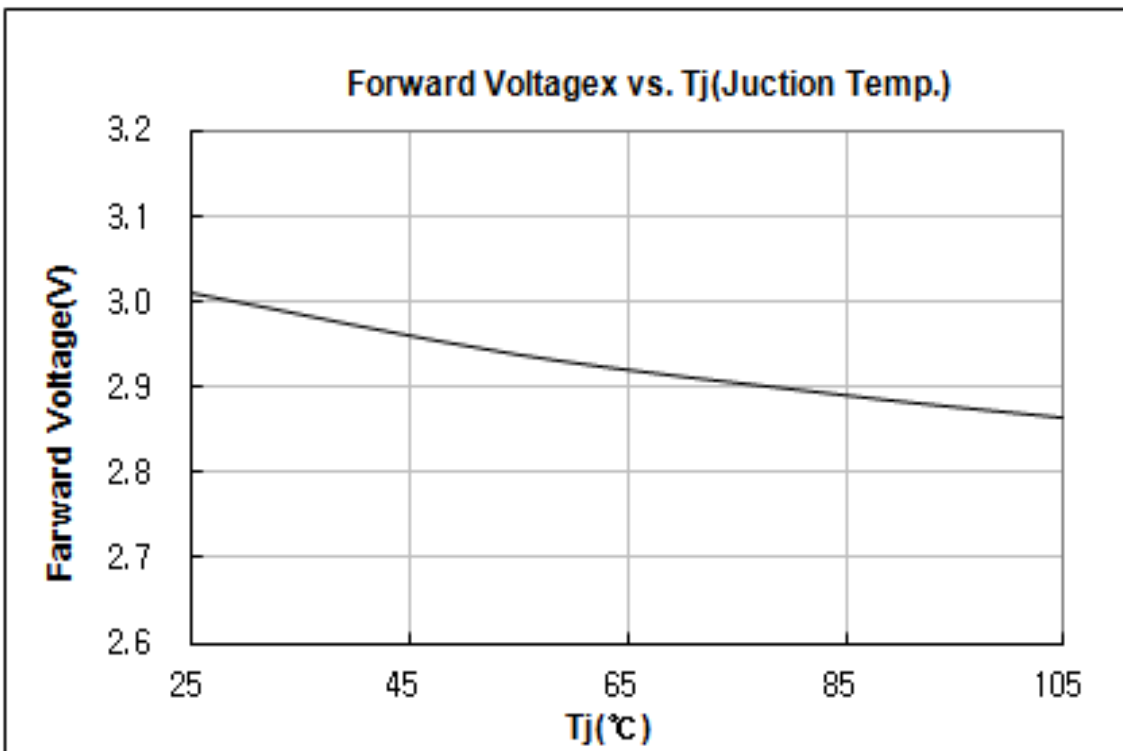

4) Color shift Characteristics

Color x,y vs. Forward Current ($I_F = 350\text{mA}$, Cool White)

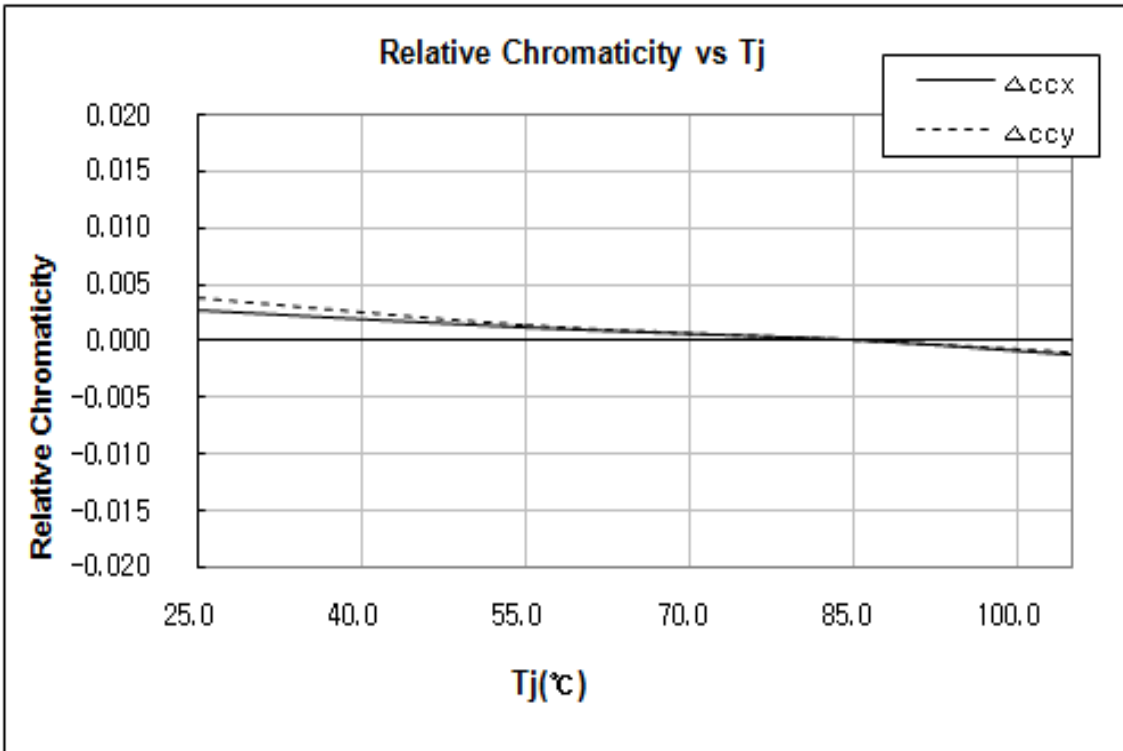

Color x,y vs. Substrate Temp. ($I_F = 350\text{mA}$, Cool White)

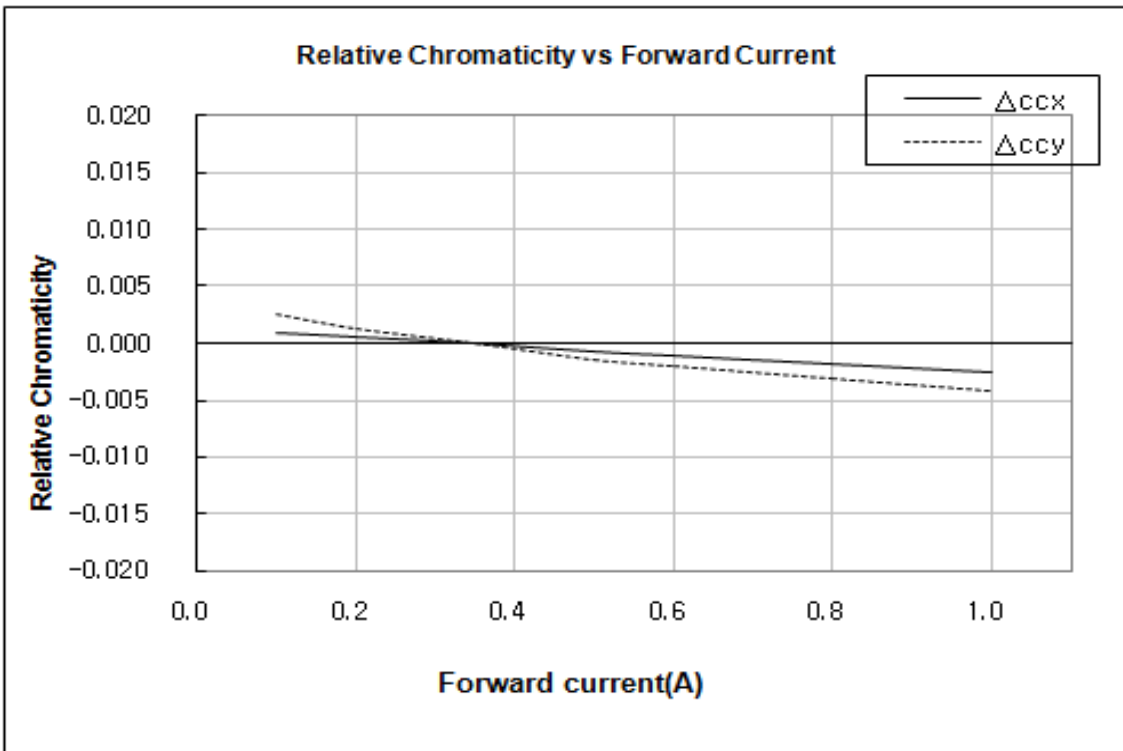

5) Derating Curve

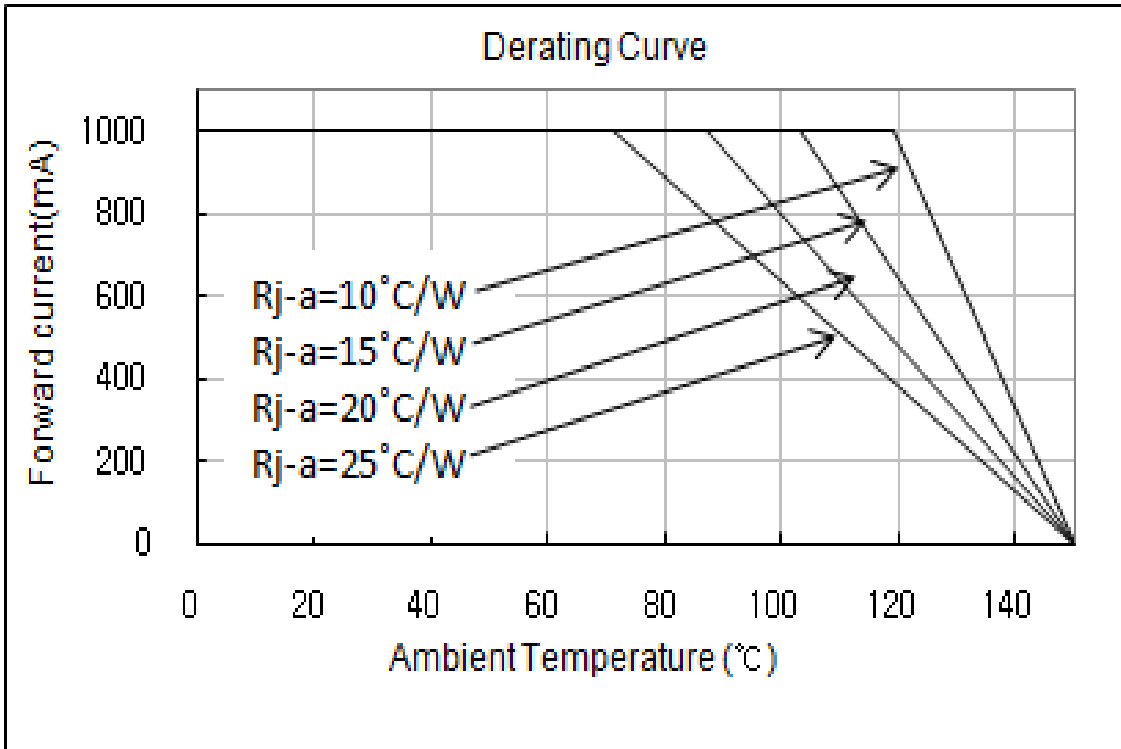

6) Viewing angle Characteristics

Viewing angle

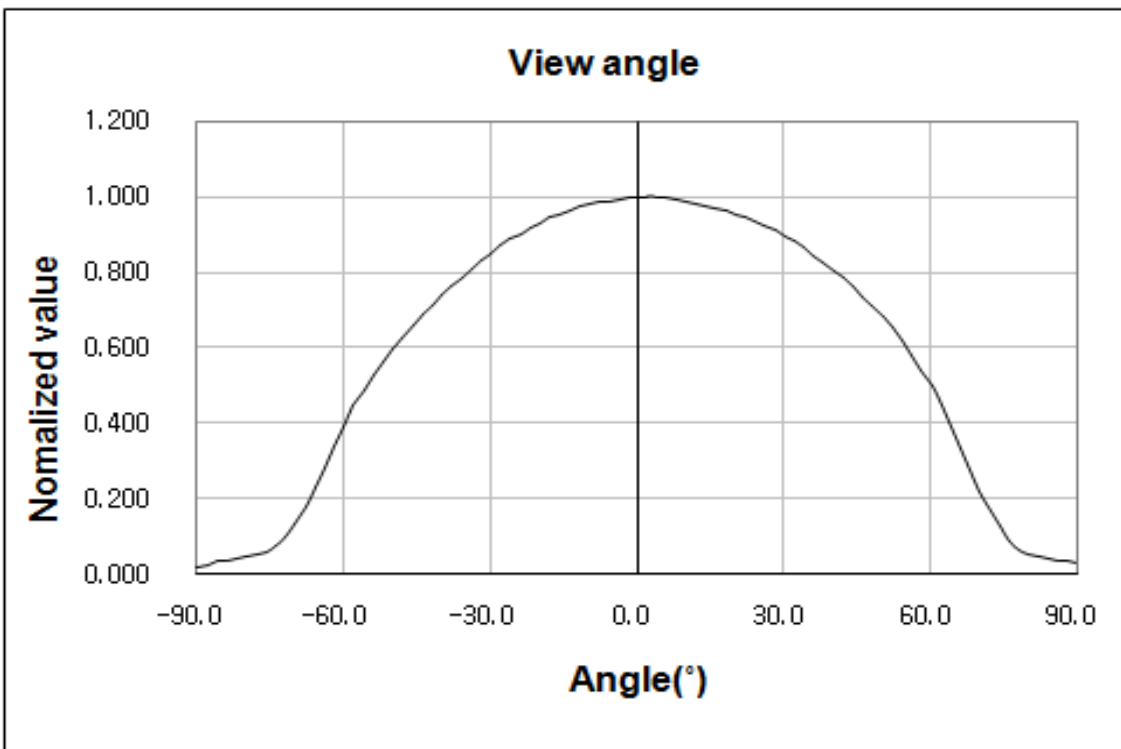

4. Outline Drawing & Dimension

Recommended Land Pattern

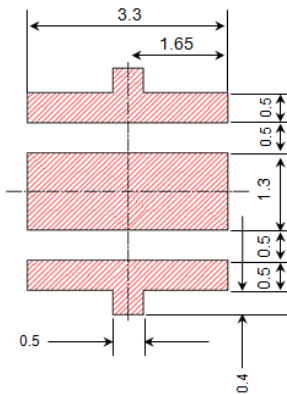
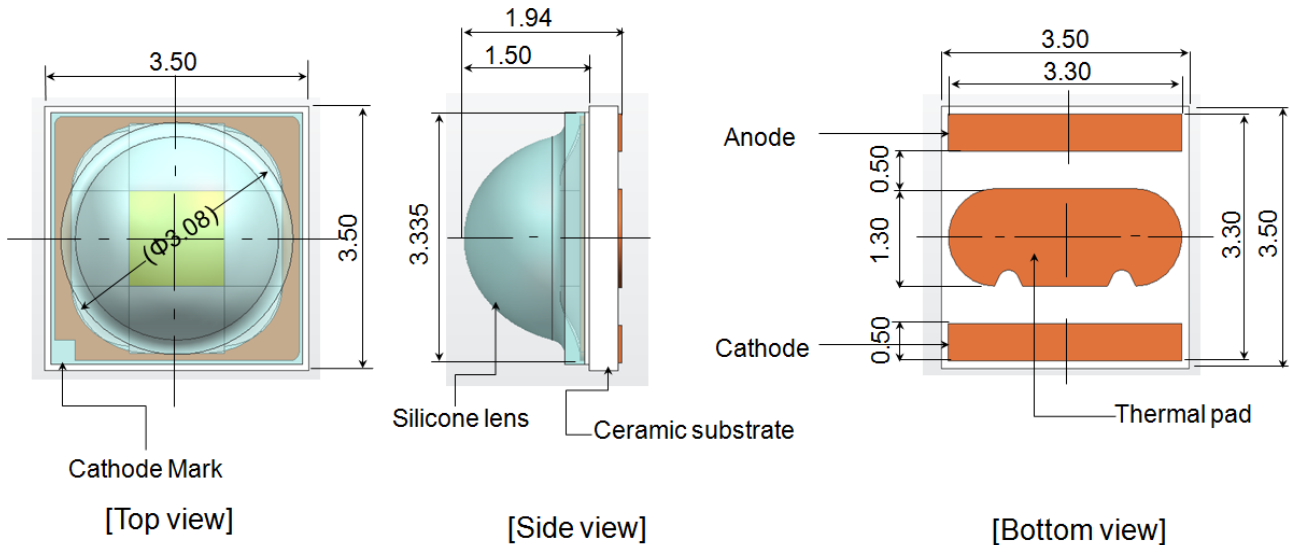

unit : mm
Tolerance : ± 0.13

* This LED has built-in ESD protection device(s) connected in parallel to LED Chip(s).

* The thermal pad is electrically isolated from the anode and cathode contact pads.

Ts Point & Measurement Method

* Measure the nearest point to the thermal pad as shown below. If necessary, remove PSR of PCB to reach Ts point.

* Thermal pad must be soldered to the PCB to dissipate heat properly. Otherwise, LED can be damaged.

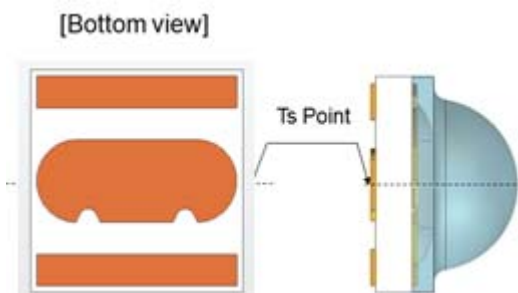

5. Reliability Test Items and Conditions

1) Test Items and Results

Test Items	Test Conditions	Test Hours/Cycles	n
Room Temperature Life Test	25℃, DC 1000 mA	1000 Hr	22
High Temperature humidity Life Test	85℃, 85%, DC 1000 mA	1000 Hr	22
High Temperature Life Test	85℃, DC 1000 mA	1000 Hr	22
Low Temperature Life Test	-40℃, DC 1000 mA	1000 Hr	22
Temperature humidity Cycle On/Off test	-40 / 85 ℃, each 20 min, 100 min transfer Power On/off each 5 min, DC 1000 mA	100 Cycles	11
Thermal Shock	-45 ℃/15 min ↔ 125 ℃/ 15 min. Temp.change within 5min.	500 Cycles	100
High Temperature Storage	Ta=120℃	1000 Hr	11
Low Temperature Storage	Ta=-40℃	1000 Hr	11
ESD(HBM)	Q1=10MΩ, R2=1.5KΩ, C=100pF, V=±5KV, 5Times	5 Times (±5kV)	5

2) Criteria for Judging the Damage

Item	Symbol	Test Condition [T _a = 25℃]	Limit	
			Min.	Max.
Forward Voltage	V _F	350 mA	L.S.L. * 0.9	U.S.L. * 1.1
Luminous flux	Im	350 mA	L.S.L. * 0.7	U.S.L. * 1.1

* U.S.L. : Upper Standard Level L.S.L. : Lower Standard Level

6. Solder Conditions

1) Reflow Conditions (Pb Free)

Reflow Frequency : 2 times max.

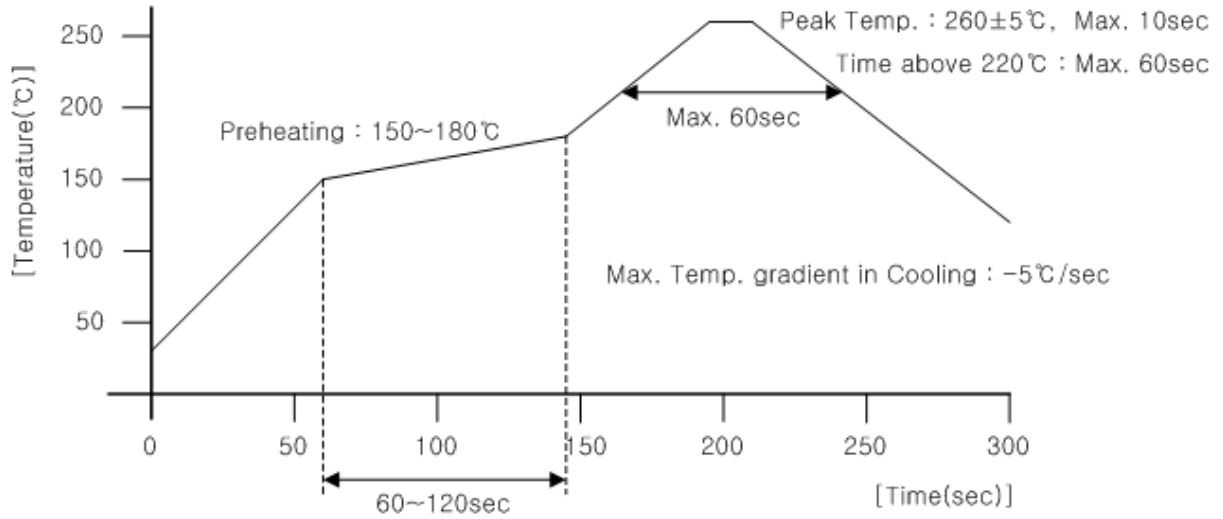

2) For Manual Soldering

Not more than 5 seconds @Max. 300°C, under soldering iron.

7. Tape And Reel

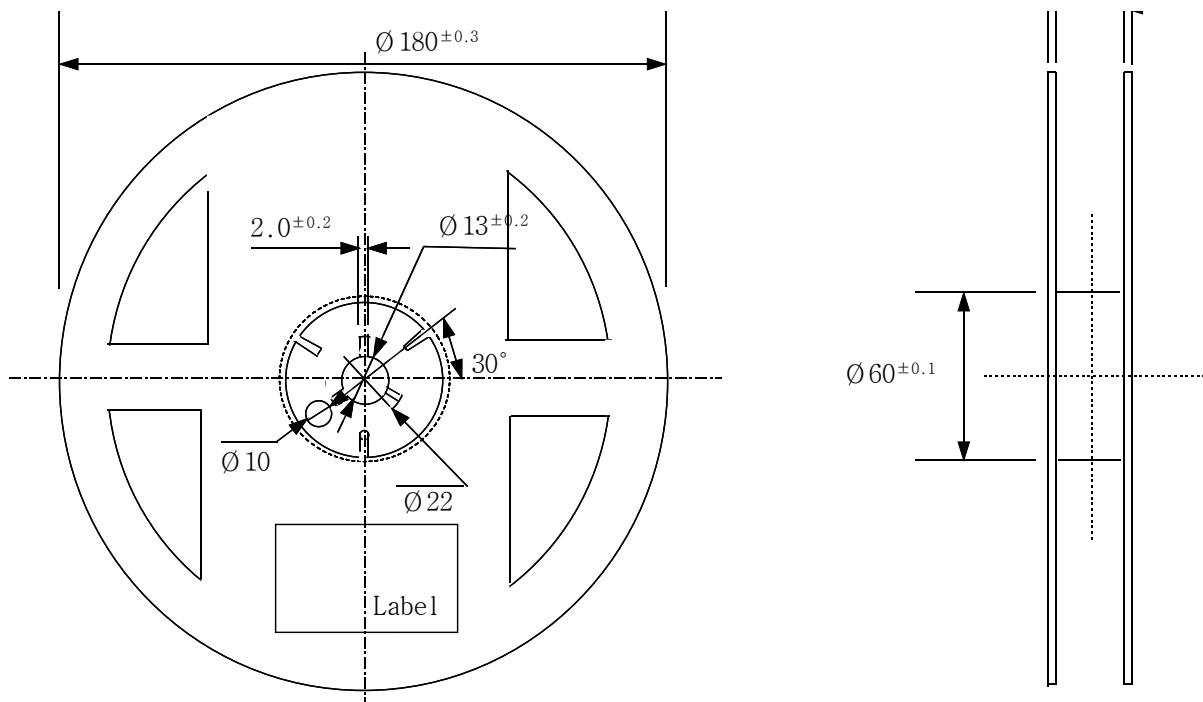
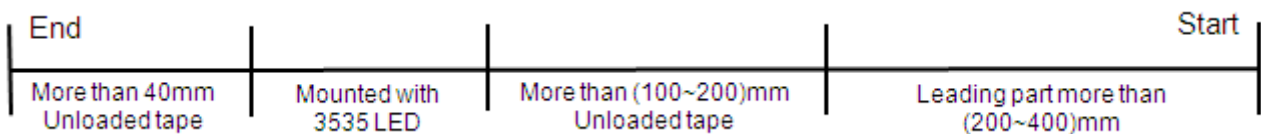
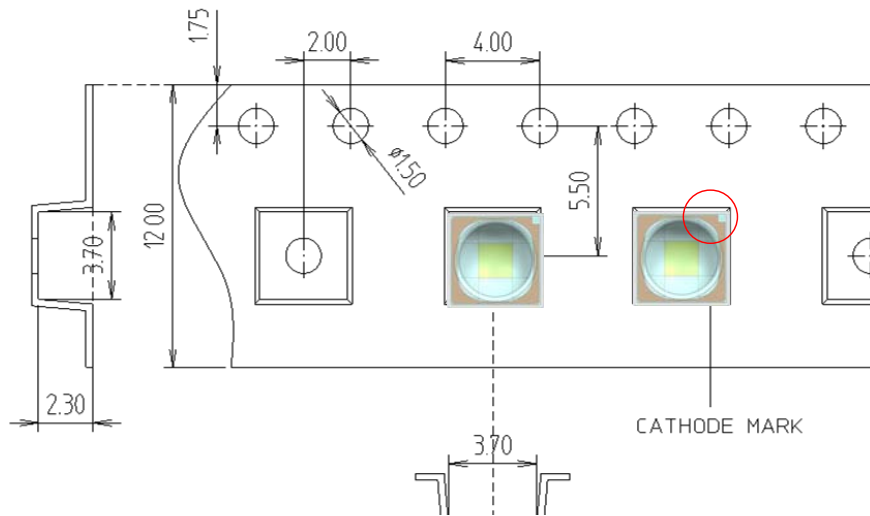

- (1) Quantity : The quantity/reel to be 1,000 pcs.
- (2) Cumulative Tolerance : Cumulative tolerance/10 pitches to be ± 0.2 mm
- (3) Adhesion Strength of Cover Tape : Adhesion strength to be 0.1-0.7N when the cover tape is turned off from the carrier tape at 10° angle to be the carrier tape.
- (4) Packaging : P/N, Manufacturing data code no. and quantity to be indicated on a damp proof package.

8. Label Structure

1) Label Structure

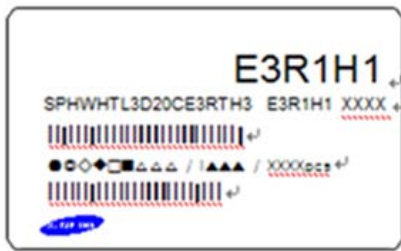

Rank Code

/E3/ : VF Rank

/R1/ : Color Rank

/H1/ : Flux Bin

2) LOT Number

The Lot number is composed of the following characters

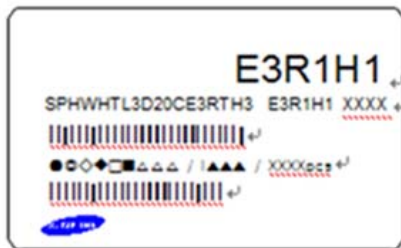

●◎◇◆□■△△△ / |▲▲▲ / 1000PCS

● : Production Site (S:SAMSUNG ELECTRONICS, G:Gosin China)

◎ : L (LED)

◇ : Product State (A:Normality, B:Bulk, C:First Production, R:Reproduction, S:Sample)

◆ : Year (U:2010, V:2011, W:2012, Y:2013...)

□ : Month (1 ~ 9, A, B)

■ : Day (1 ~ 9, A, B ~ V)

△ : SAMSUNG ELECTRONICS Product Number (1 ~ 999)

▲ : Reel Number (1 ~ 999)

9. Packing Structure

1) Packing Process

Reel



Aluminum Vinyl Bag

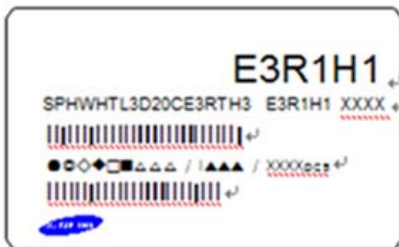

Inner Box (Max. 2reel)



Material : Paper(SW3B(B))

TYPE	SIZE(mm)		
	a	b	c
7inch	219	185	44

Out Box (Max. 5 inner box)

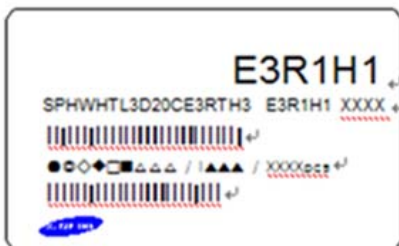

Material : Paper(SW3B(B))

TYPE	SIZE(mm)		
	a	b	c
7inch	245	194	232

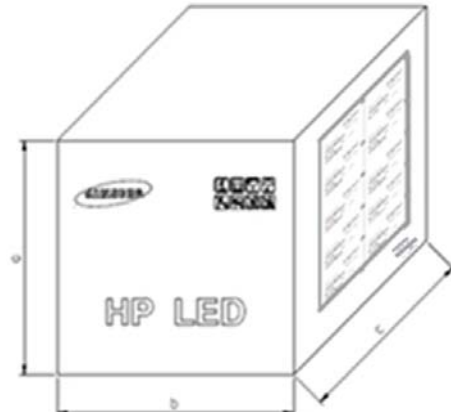
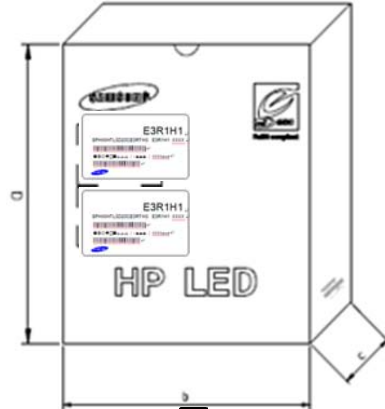
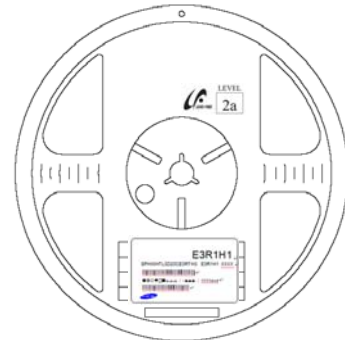

2) Aluminum Packing Bag



CAUTION

This bag contains
MOISTURE SENSITIVE DEVICES

LEVEL

2a

1. Shelf life in sealed bag: 12 months at 40°C and 90% relative humidity (RH)
2. Peak package body temperature: 240°C
3. After this bag is opened, devices that will be subjected to reflow solder or other high temperature processes must be:
 - a. Mounted within 672 hours at factory conditions of equal to or less than 30°C / 60% RH, or
 - b. Stored at 10% RH
4. Devices require bake, before mounting, if:
 - a. Humidity Indicator Card is > 65% when read at $23 \pm 5^{\circ}\text{C}$, or
 - b. 2a is not met.
5. If baking is required, devices must be baked for 1 hours at $60 \pm 5^{\circ}\text{C}$

Note: if device containers cannot be subjected to high temperature or shorter bake times are desired, reference IPC/JEDEC J-STD-033 for bake procedure,

Bag seal due date: _____
(if blank, see code label)

Note: Level and body temperature by IPC/JEDEC J-STD-020

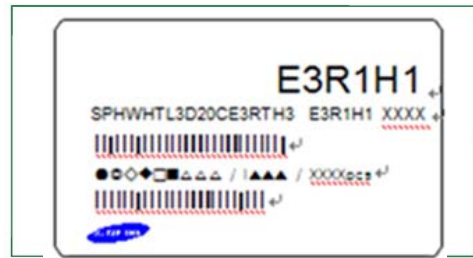

ATTENTION
OBSERVE PRECAUTIONS
FOR HANDLING
ELECTROSTATIC
SENSITIVE
DEVICES



■ 주의 사항

이 알루미늄 지퍼 백은 습기 및 정전기로부터 제품을 보호하기 위하여 제작되었습니다. 개봉 후에는 즉시 솔더 작업을 실시하는 것을 권장합니다.

습기 및 정전기로부터 제품을 보호 하기 위해서 개봉 후 사용하지 않는 자재는 본 팩에 넣어 보관 하시기 바랍니다. 사용하지 않는 자재를 본 팩에 넣을 때는 반드시 동봉된 드라이 팩과 함께 넣고 지퍼부분을 완전하게 밀봉하여 주시기 바랍니다.

■ Important

This Al Zipper bag is designed to protect the enclosed products from moisture and ESD. Once opened, the products should be soldered onto the printed circuit board immediately. When not in use, please do not leave the products unprotected by the Al Zipper Bag. To repack unused products., please ensure the zip-lock is completely sealed with the dry pack left inside.

There are Silica Gel and Humidity Indicator Card in the Aluminum Bag

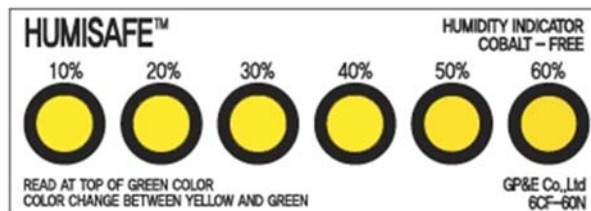

10. Precaution for use

- 1) For over current-protection, customers are recommended to apply resistors connected in series with the LEDs to mitigate sudden change of the forward current caused by shift of the forward voltage.
- 2) This device should not be used in any type of fluid such as water, oil, organic solvent, etc. When cleaning is required, IPA is recommended as cleaning agent. Solvent-based cleaning agent such as Zestron^(R) may damage the silicone resins used in the device.
- 3) When the device is in operation, the forward current should be carefully determined considering the maximum ambient temperature and the corresponding junction temperature.
- 4) LEDs must be stored in a clean environment. If the LEDs are to be stored for 3 months or more after being shipped from SAMSUNG ELECTRONICS, they should be packed with a nitrogen-filled container.
(Shelf life of sealed bags: 12 months, temp. 0~40°C, 0~90%RH)
- 5) After storage bag is open, device subject to soldering, solder reflow, or other high temperature processes must be:
 - a. Mounted within 672 hours (28 days) at an assembly line with a condition of no more than 30°C/60%RH.
 - b. Stored at <10% RH.
- 6) Repack unused Products with anti-moisture packing, fold to close any opening and then store in a dry place.
- 7) Devices require baking before mounting, if humidity card reading reaches 60% at 23±5°C.
- 8) Devices must be baked for 1hours at 60±5°C, if baking is required.
- 9) The LEDs are sensitive to the static electricity and surge current. It is recommended to use a wrist band or anti-electrostatic glove when handling the LEDs.
If voltage exceeding the absolute maximum rating is applied to LEDs, it may cause damage or even destruction to LED devices.
Damaged LEDs may show some unusual characteristics such as increase in leakage current, lowered turn-on voltage, or abnormal lighting of LEDs at low current.
- 10) VOCs (volatile organic compounds) can be generated from adhesives, flux, hardener or organic additives used in luminaires (fixtures). Transparent LED silicone encapsulant is permeable to those chemicals and they may lead a discoloration of encapsulant when they expose to heat or light. This phenomenon can cause a significant loss of light emitted(output) from the luminaires(fixture). This phenomenon can give a significant loss of light emitted(output) from the luminaires(fixture). In order to prevent these problems, we recommend you to know the physical properties of materials used in luminaires, They must be selected carefully.



11) Risk of Sulfurization (or Tarnishing)

The LED from Samsung Electronics uses a silver-plated lead frame and its surface color may change to black(or dark colored) when it is exposed to sulfur (S), chlorine (Cl) or other halogen compound. Sulfurization of lead frame may cause intensity degradation, change of chromaticity coordinates and, in extreme cases, open circuit. It requires caution. Due to possible sulfurization of lead frame, LED should not be used and stored together with oxidizing substances made of materials in a following list,
: Rubber, plain paper, lead solder cream and so on.

11. Hazard Substance Analysis



Test Report No. F690101/LF-CTSAYAA13-16056

Issued Date: 2013. 04. 04 Page 1 of 7

To: **SAMSUNG ELECTRONICS CO., LTD.**
San#24 Nongseo-dong
Giheung-gu
Yongin-si
Gyeonggi-do
Korea

The following merchandise was submitted and identified by the client as :

SGS File No.	: AYAA13-16056
Product Name	: SPHWHTL3D
Item No./Part No.	: LH351Z
Received Date	: 2013. 04. 01
Test Period	: 2013. 04. 02 to 2013. 04. 04
Test Results	: For further details, please refer to following page(s)
Test Performed	: SGS Korea tested the sample(s) selected by applicant with following results.
Test Comments	: By the applicant's specific request, the sampling and testing was performed only for the part indicated in the photo without disassembly.

Timothy Jeon
Jinhee Kim
Cindy Park
Jerry Jung/ Testing Person

SGS Korea Co., Ltd.

Jeff Jang / Chemical Lab Mgr

This document is issued by the Company subject to the General Conditions of Service printed overleaf, available on request or accessible at <http://www.sgs.com/ServiceConditions> and, for electronic format documents, subject to Terms and Conditions for Electronic Documents at <http://www.sgs.com/ServiceConditions>. Attention is drawn to the limitation of liability, indemnification and jurisdiction clause defined therein. Any holder of this document is advised that information contained herein reflects the Company's findings at the time of its issuance only and within the limits of Client's instructions, if any. The Company's sole responsibility is to its Client and this document does not exonerate parties to a transaction from complying with their rights and obligations under the transaction documents. This document cannot be reproduced except in full, without prior written approval of the Company. Any unauthorized alteration, forgery or falsification of the content or appearance of this document is unlawful and offenders may be prosecuted to the fullest extent of the law. Certain information within this test report may only be the property of the client and such information will remain the client's property.

FD52 Versions

SGS Korea Co., Ltd.

322, The O valley, 555-8, Hoggae-dong, Dongen-gu, Anyang-si, Gyeonggi-do, Korea 431-080
T +82 (0)31 4908 000 F +82 (0)31 4908 050 <http://www.sgslab.co.kr> www.kr.sgs.com/sgslab

Member of the SGS Group (Société Générale de Surveillance)

Test Report No. F690101/LF-CTSAYAA13-16056

Issued Date: 2013. 04. 04 Page 2 of 7

Sample No. : AYAA13-16056.001
Sample Description : SPHWHTL3D
Item No./Part No. : LH351Z
Materials : Al2O3,Cu,Ni,Pd,Au,Silicone,Phosphor

Heavy Metals

Test Items	Unit	Test Method	MDL	Results
Cadmium (Cd)	mg/kg	With reference to IEC 62321:2008, ICP	0.5	N.D.
Lead (Pb)	mg/kg	With reference to IEC 62321:2008, ICP	5	N.D.
Mercury (Hg)	mg/kg	With reference to IEC 62321:2008, ICP	2	N.D.
Hexavalent Chromium (Cr VI)	mg/kg	With reference to IEC 62321:2008, UV-VIS	1	N.D.

Flame Retardants-PBBs/PBDEs

Test Items	Unit	Test Method	MDL	Results
Monobromobiphenyl	mg/kg	With reference to IEC 62321:2008, GC-MS	5	N.D.
Dibromobiphenyl	mg/kg	With reference to IEC 62321:2008, GC-MS	5	N.D.
Tribromobiphenyl	mg/kg	With reference to IEC 62321:2008, GC-MS	5	N.D.
Tetrabromobiphenyl	mg/kg	With reference to IEC 62321:2008, GC-MS	5	N.D.
Pentabromobiphenyl	mg/kg	With reference to IEC 62321:2008, GC-MS	5	N.D.
Hexabromobiphenyl	mg/kg	With reference to IEC 62321:2008, GC-MS	5	N.D.
Heptabromobiphenyl	mg/kg	With reference to IEC 62321:2008, GC-MS	5	N.D.
Octabromobiphenyl	mg/kg	With reference to IEC 62321:2008, GC-MS	5	N.D.
Nonabromobiphenyl	mg/kg	With reference to IEC 62321:2008, GC-MS	5	N.D.
Decabromobiphenyl	mg/kg	With reference to IEC 62321:2008, GC-MS	5	N.D.
Monobromodiphenyl ether	mg/kg	With reference to IEC 62321:2008, GC-MS	5	N.D.
Dibromodiphenyl ether	mg/kg	With reference to IEC 62321:2008, GC-MS	5	N.D.
Tribromodiphenyl ether	mg/kg	With reference to IEC 62321:2008, GC-MS	5	N.D.
Tetrabromodiphenyl ether	mg/kg	With reference to IEC 62321:2008, GC-MS	5	N.D.
Pentabromodiphenyl ether	mg/kg	With reference to IEC 62321:2008, GC-MS	5	N.D.
Hexabromodiphenyl ether	mg/kg	With reference to IEC 62321:2008, GC-MS	5	N.D.
Heptabromodiphenyl ether	mg/kg	With reference to IEC 62321:2008, GC-MS	5	N.D.
Octabromodiphenyl ether	mg/kg	With reference to IEC 62321:2008, GC-MS	5	N.D.

NOTE:

- (1) N.D. = Not detected.(<MDL)
- (2) mg/kg = ppm
- (3) MDL = Method Detection Limit
- (4) - = No regulation
- (5) Negative = Undetectable / Positive = Detectable
- (6) ** = Qualitative analysis (No Unit)
- (7) * = Boiling-water-extraction:
 Negative = Absence of CrVI coating
 Positive = Presence of CrVI coating; the detected concentration in boiling-water-extraction solution is equal or greater than 0.02 mg/kg with 50 cm2 sample surface area.

The document issued by the Company subject to the General Conditions of Service printed on the back of this report is available at <http://www.sgs.com> or <http://www.sgs.com/sgsweb> for electronic format documents, subject to the same General Conditions of Service. The Company is not responsible for the content of the document if it is altered or modified after its issue. Any data or information contained in this report is for the use of the client only and is not to be used for any other purpose without the prior written approval of the Company. Any use of the data or information contained in this report for any other purpose is at the user's risk. The Company is not responsible for the content of the document if it is altered or modified after its issue. Any data or information contained in this report is for the use of the client only and is not to be used for any other purpose without the prior written approval of the Company. Any use of the data or information contained in this report for any other purpose is at the user's risk.

SGS Korea Co., Ltd.

 322, The Ovalley, 595-B, Hogeje-dong, Dongan-gu, Anyang-si, Gyeonggi-do, Korea 431-080
 T +82 (0)31 4608 000 F +82 (0)31 4608 059 <http://www.sgs.co.kr> www.kr.sgs.com/sgsweb

F052 Version5

Member of the SGS Group (Société Générale de Surveillance)



Test Report No. F690101/LF-CTSAYAA13-16056

Issued Date: 2013. 04. 04 Page 3 of 7

Sample No. : AYAA13-16056.001
 Sample Description : SPHWHTL3D
 Item No./Part No. : LH351Z
 Materials : Al2O3,Cu,Ni,Pd,Au,Silicone,Phosphor

Flame Retardants-PBBs/PBDEs

Test Items	Unit	Test Method	MDL	Results
Nonabromodiphenyl ether	mg/kg	With reference to IEC 62321:2008, GC-MS	5	N.D.
Decabromodiphenyl ether	mg/kg	With reference to IEC 62321:2008, GC-MS	5	N.D.

Halogen Content

Test Items	Unit	Test Method	MDL	Results
Bromine(Br)	mg/kg	BS EN 14582:2007 , IC	30	N.D.
Chlorine(Cl)	mg/kg	BS EN 14582:2007 , IC	30	N.D.
Fluorine(F)	mg/kg	BS EN 14582:2007 , IC	30	N.D.
Iodine(I)	mg/kg	BS EN 14582:2007 , IC	50	N.D.

NOTE:

- (1) N.D. = Not detected. (<MDL)
- (2) mg/kg = ppm
- (3) MDL = Method Detection Limit
- (4) - = No regulation
- (5) Negative = Undetectable / Positive = Detectable
- (6) ** = Qualitative analysis (No Unit)
- (7) * = Boiling-water-extraction:
 Negative = Absence of CrVI coating
 Positive = Presence of CrVI coating; the detected concentration in boiling-water-extraction solution is equal or greater than 0.02 mg/kg with 50 cm2 sample surface area.

The document issued by the Company is subject to the General Conditions of Service printed on the back of the report or available at www.sgs.com. The document is the property of SGS and shall remain the property of SGS. No part of this document may be reproduced or transmitted in any form or by any means electronic, mechanical, photocopying, recording, or by any information storage and retrieval system, without the prior written permission of SGS. The document is not to be used for any other purpose than that for which it was issued. The Company is not responsible for any loss or damage to the original or copies of this document.



Test Report No. F690101/LF-CTSAYAA13-16056

Issued Date: 2013. 04. 04 Page 4 of 7

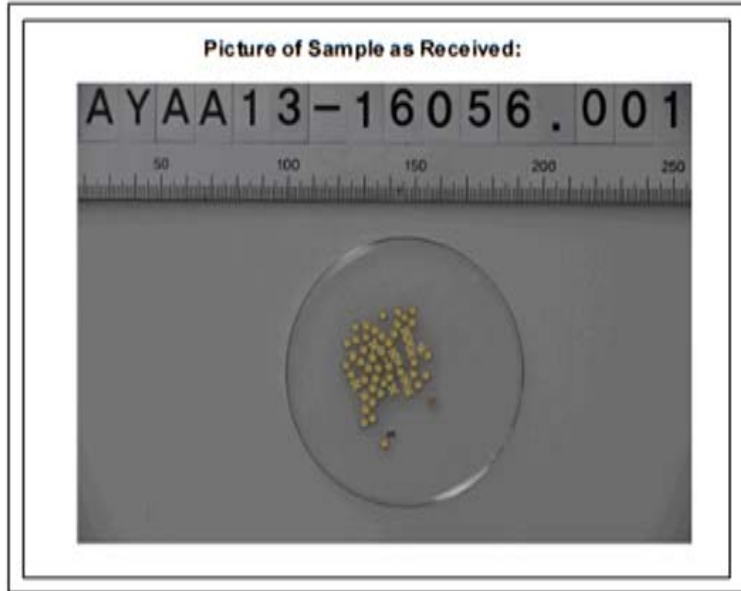

NOTE:

- (1) N.D. = Not detected, (<MDL)
- (2) mg/kg = ppm
- (3) MDL = Method Detection Limit
- (4) - = No regulation
- (5) Negative = Undetectable / Positive = Detectable
- (6) ** = Qualitative analysis (No Unit)
- (7) * = Boiling-water-extraction:
 Negative = Absence of CrVI coating
 Positive = Presence of CrVI coating; the detected concentration in boiling-water-extraction solution is equal or greater than 0.02 mg/kg with 50 cm² sample surface area.

This document is issued by the Company subject to the General Conditions of Service printed on each envelope or request or available at www.sgs.com. The client is advised that the results of the analysis are only valid for the sample as received and for the purpose for which it was submitted. The client is also advised that the results of the analysis are only valid for the sample as received and for the purpose for which it was submitted. The client is also advised that the results of the analysis are only valid for the sample as received and for the purpose for which it was submitted.



Test Report No. F690101/LF-CTSAYAA13-16056

Issued Date: 2013. 04. 04 Page 5 of 7

Testing Flow Chart for RoHS: Cd/Pb/Hg/Cr⁶⁺ /PBBs&PBDEs Testing

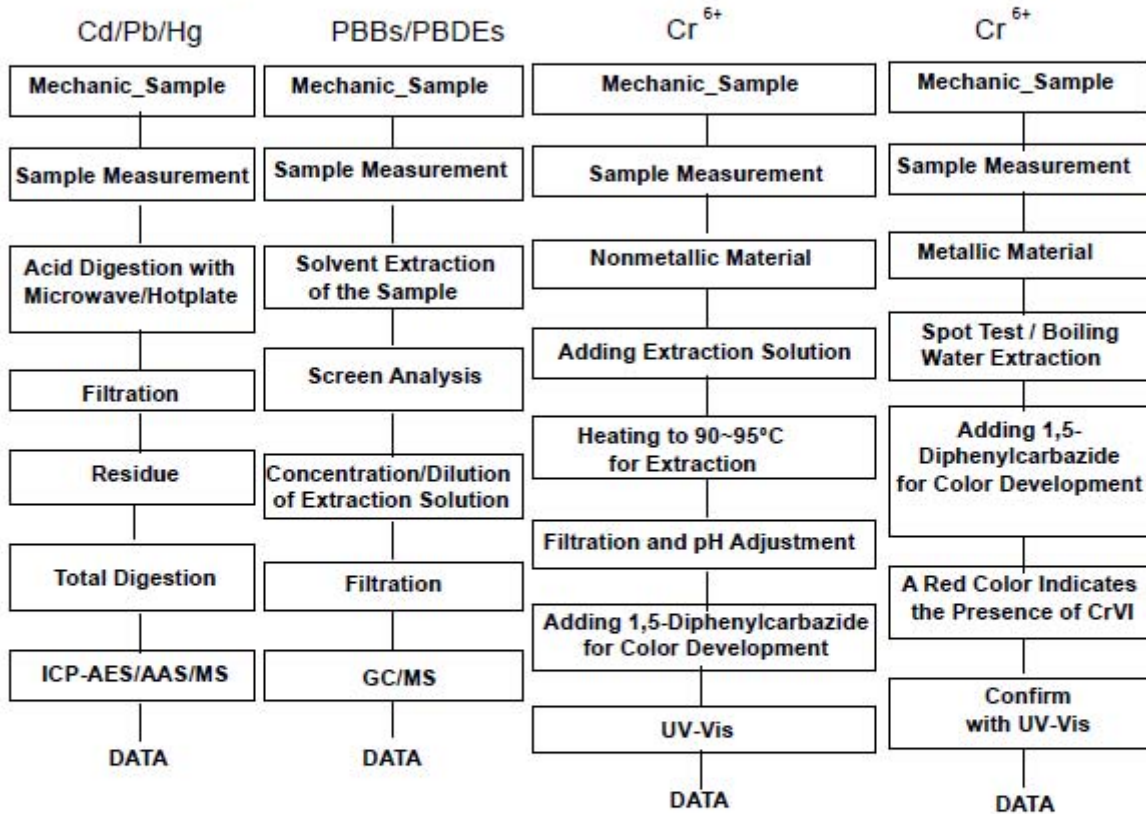

NOTE:

- (1) N.D. = Not detected.(<MDL)
- (2) mg/kg = ppm
- (3) MDL = Method Detection Limit
- (4) - = No regulation
- (5) Negative = Undetectable / Positive = Detectable
- (6) ** = Qualitative analysis (No Unit)
- (7) * = Boiling-water-extraction:
 Negative = Absence of CrVI coating
 Positive = Presence of CrVI coating; the detected concentration in boiling-water-extraction solution is equal or greater than 0.02 mg/kg with 50 cm² sample surface area.

This document is issued by the Company subject to its General Conditions of Service printed, available on request or accessible at <http://www.sgs.com/Products/Chemical/Chemical.aspx>, and, for electronic format documents, subject to Terms and Conditions for Electronic Documents at <http://www.sgs.com/Products/Chemical/Chemical.aspx>. Attention is drawn to the limitation of liability, indemnification and jurisdiction clauses defined therein. Any holder of this document is advised that information contained herein reflects the Company's findings at the time of its issuance only and within the limits of Client's instructions, if any. The Company's sole responsibility is to its Client and this document does not constitute parties to a transaction from rendering of their rights and obligations under the transaction documents. This document cannot be reproduced except in full, without prior written approval of the Company. Any unauthorized alteration, copying or distribution of the content or appearance of this document is unlawful and offenders may be prosecuted to the fullest extent of the law. Online information cannot be reproduced in the test report other than in the sampling label and such sampling are related to 20 days only.

FD52 Version5

SGS Korea Co., Ltd.

322, The O valley, 555-0, Hoggae-dong, Dongan-gu, Anyang-si, Gyeonggi-do, Korea 431-080
 T +82 (0)31 4908 000 F +82 (0)31 4908 059 <http://www.sgs.com> www.kr.sgs.com/greentab

Member of the SGS Group (Société Générale de Surveillance)



Test Report No. F690101/LF-CTSAYAA13-16056

Issued Date: 2013. 04. 04 Page 6 of 7

The samples were dissolved totally by pre-conditioning method according to above flow chart for Cd,Pb,Hg.
Section Chief : Gilsae Yi

Flow Chart for Halogen Test

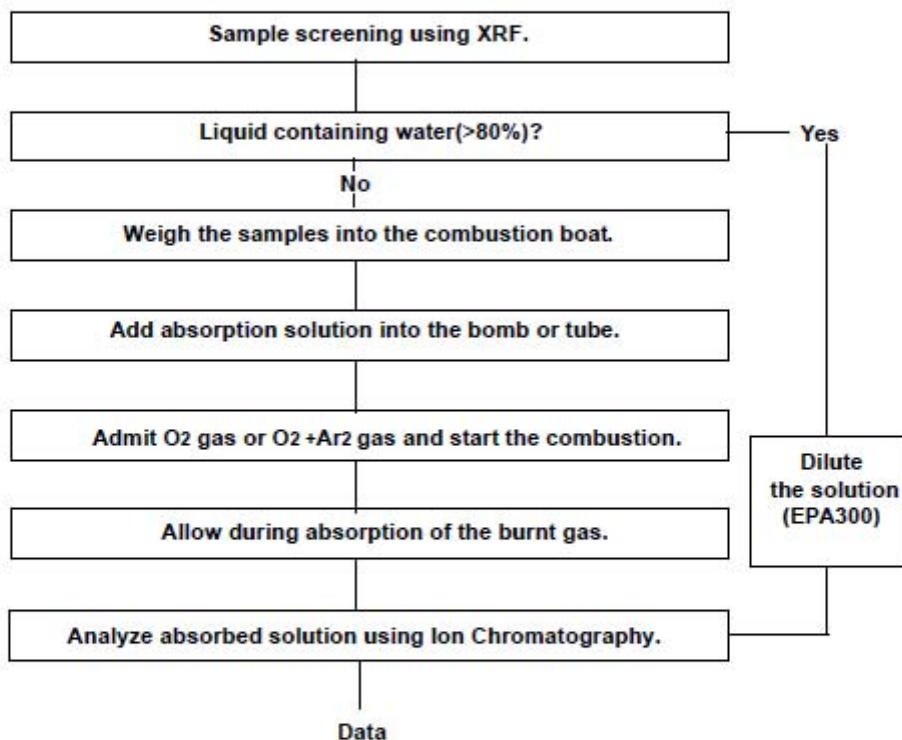

NOTE:

- (1) N.D. = Not detected.(<MDL)
- (2) mg/kg = ppm
- (3) MDL = Method Detection Limit
- (4) - = No regulation
- (5) Negative = Undetectable / Positive = Detectable
- (6) ** = Qualitative analysis (No Unit)
- (7) * = Boiling-water-extraction:
 Negative = Absence of CrVI coating
 Positive = Presence of CrVI coating; the detected concentration in boiling-water-extraction solution is equal or greater than 0.02 mg/kg with 50 cm2 sample surface area.

This document is issued by the Company subject to its General Conditions of Service printed hereon, available on request or accessible at <http://www.sgs.com> and, for electronic format documents, subject to Terms and Conditions for Electronic Documents at http://www.sgs.com/secure/sgs_electronic_documents.html. Attention is drawn to the limitation of liability, indemnification and jurisdiction clauses set forth therein. Any holder of this document is advised that the electronic version is deemed to be the Company's final and the true one for all purposes only and within the limits of its jurisdiction. If any discrepancy or inconsistency is found between the electronic version and the printed version, the electronic version shall prevail. The Company does not assume any liability for the accuracy or completeness of the information contained in this document and no warranty is made by the Company in relation to the accuracy or completeness of the information contained in this document. This document cannot be reproduced except in full, without prior written approval of the Company. Any unauthorized alteration, forgery or falsification of the content or appearance of this document is unlawful and offenders may be prosecuted to the fullest extent of the law. Online observation of the results shown in this report must refer only to the sample(s) tested and such sample(s) are retained for 30 days only.



Test Report No. F690101/LF-CTSAYAA13-16056

Issued Date: 2013. 04. 04 Page 7 of 7

*** End ***

NOTE:

- (1) N.D. = Not detected.(<MDL)
- (2) mg/kg = ppm
- (3) MDL = Method Detection Limit
- (4) - = No regulation
- (5) Negative = Undetectable / Positive = Detectable
- (6) ** = Qualitative analysis (No Unit)
- (7) * = Boiling-water-extraction:
 - Negative = Absence of CrVI coating
 - Positive = Presence of CrVI coating; the detected concentration in boiling-water-extraction solution is equal or greater than 0.02 mg/kg with 50 cm2 sample surface area.

This document is issued by the Company subject to its General Conditions of Service printed overleaf, available on request or accessible at <http://www.sgs.com/ServiceConditions.html>, for electronic format documents, subject to Terms and Conditions for Electronic Documents at <http://www.sgs.com/electronicdocuments>. Attention is drawn to the limitation of liability, indemnification and jurisdiction clauses defined therein. Any holder of this document is advised that information contained herein reflects the Company's findings at the time of its intervention only and within the limits of Client's instructions, if any. The Company's sole responsibility is to its Client and the document does not constitute parties to a transaction nor does it confer any rights and obligations upon the transaction documents. This document cannot be reproduced except in full, without prior written approval of the Company. Any unauthorized alteration, forgery or falsification of the content or appearance of this document is unlawful and offenders may be prosecuted to the fullest extent of the law. Unless otherwise stated the results shown in this test report refer only to the sample(s) tested and such sample(s) are retained for 30 days only.

F052 Versions

SGS Korea Co.,Ltd.

322, The O valley, 555-B, Hoge-dong, Dongen-gu, Anyang-si, Gyeonggi-do, Korea 431-080
t +82 (0)31 4808 000 f +82 (0)31 4808 050 <http://www.sgslab.co.kr> www.ko.sgs.com/greentlab

Member of the SGS Group (Société Générale de Surveillance)

<h2>Revision History</h2>

Date	Revision History	Writer	
		Drawn	Approved
2013.07.24	New version	S.B.HONG	Y.T.KIM
2013.08.03	1st	S.B.HONG	Y.T.KIM
2013.10.15	2nd	S.B.HONG	Y.T.KIM
2013.11.11	3rd	S.B.HONG	Y.T.KIM
2013.11.28	4th	S.B.HONG	Y.T.KIM
2014.01.08	5th	S.B.HONG	Y.T.KIM
2014.01.09	6th	S.B.HONG	Y.T.KIM
2014.01.14	7th	S.B.HONG	Y.T.KIM
2014.03.31	8th	S.B.HONG	M.Y.Son
2014.04.15	9th	S.B.HONG	M.Y.Son