

**CMD12-21 Bright★Angle™ Right Angle Surface Mount LED**  
**DESCRIPTION AND FEATURES**

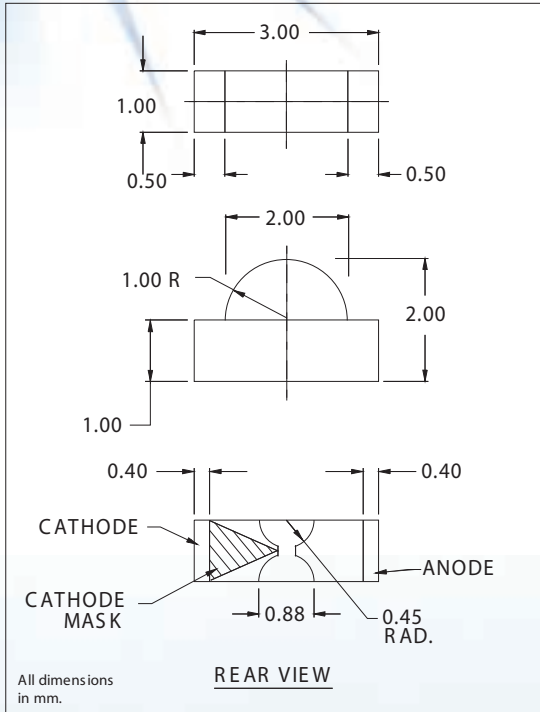

**Surface Mount Technology**

- Tape and reel packaged for high-speed autoinsertion.
- Convection and vapor-phase reflow compatible.
- Compact form enables high density placement.
- Packaged 2000 pieces per reel.

**Leading Edge LED Optoelectronic Performance**

- Consistent high brightness.
- Integral lensing for narrow angle light dispersion.
- Bi-color available.

**Exceptional Reliability**

- Stringent process controls assure quality.
- Extensive qualification testing to meet strictest requirements.
- Designed to permit easy post-reflow solder joint inspection.
- Solder pad geometry on page 1-X2.

**ELECTRO-OPTICAL CHARACTERISTICS**

Part Number	Emitted Color	Lens Color	Luminous Intensity		Forward Voltage		Viewing Angle (degrees)	Peak Wavelength (nm)
			Min. (mcd)	Typ. (mcd)	Typ. (V)	Max. (V)		
CMD12-21SRC/TR8	Red	Clear	14.0	24.0	1.7	2.4	120	660
CMD12-21VRC/TR8	H.E. Red	Clear	3.0	5.0	2.0	2.8	120	640
CMD12-21VYC/TR8	Yellow	Clear	1.5	3.0	2.0	2.8	120	585
CMD12-21VGC/TR8	Green	Clear	4.4	8.8	2.1	2.8	120	570
CMD12-21UGC/TR8	Green	Clear	9.0	14.9	2.1	2.8	120	570
CMD12-21UYC/TR8	Super Yellow	Clear	36.0	60.0	2.1	2.8	120	590
CMD12-21USOC/TR8	Sunset Orange	Clear	43.0	71.0	2.1	2.8	120	620

**ABSOLUTE MAXIMUM RATINGS**

	Green	H.E.Red	Yellow	Red	Units
Power Dissipation.....	100	105	85	105	mW
Storage/Operating Temperature.....	-40 to +85	-40 to +85	-40 to +85	-40 to +85	°C
Peak Forward Current (1µs @ 10% duty cycle).....	150	150	150	150	mA
Reverse Voltage (IR=100µA).....	4.0	4.0	4.0	4.0	V
Lead Solder Time @ 260°C.....	5	5	5	5	Seconds
Average Forward Current.....	30	30	30	30	mA