



Ultrasonic Displacement Sensor

E4DA

Sensor's Narrow Ultrasonic Beam Accurately Detects Small Objects, Provides Linear Analog Output for Inspection and Measurement

- Narrow 5 mm ultrasonic beam detects objects as small as 1 mm diameter at 50 mm distance with 0.2 mm resolution
- Amplifier provides three inspection outputs—high, pass and low
- Amplifier provides 4 to 20 mA analog output
- Alarm output helps identify irregular beam reflection
- Input hold function retains previous input level, up to 40 ms, to stabilize operation
- External gate input and 40 ms OFF-delay available on amplifier
- Fast, 2 ms response time
- 30 to 70 mm sensing distance

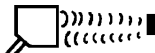

Sensing	Supply voltage	Output	
Ultrasonic beam  30 to 70 mm	12 to 24 VDC	 80 mA, 30 VDC	 4 to 20 mA

Ordering Information

■ SENSOR

Description	Part number
Sensing distance 30 to 70 mm (1.18 to 2.76 in)	E4DA-LS7

■ AMPLIFIER

Description	Part number
High, pass and low discrimination outputs	E4DA-WL1C

■ ACCESSORIES

Description	Part number
Replacement sensor mounting bracket	E39-L52
5-meter extension cable between sensor and amplifier	E49-DD5

■ LINEAR OUTPUT VS. SENSING DISTANCE

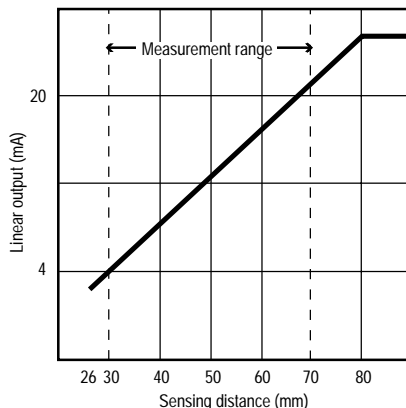

The linear output of the sensor is locked between 21.8 to 28 mA when the target is outside the measurement range. There is no linear output when the target measurement distance is less than 26 mm.

Specifications

■ SENSOR E4DA-LS7

Method of detection		Ultrasonic displacement
Sensing distance		30 to 70 mm (1.18 to 2.76 in) with 40 x 40 mm (1.57 x 1.57 in) flat object
Minimum detectable object		1 mm (0.04 in) diameter at 50 mm (1.97 in) sensing distance without a background object
Resolution		0.2 mm (0.008 in) at 50 mm (1.97 in)
Differential travel		1 to 3% of 70 mm (2.76 in) rated sensing distance
Directional angle		±3° max.
Variation due to temperature changes		±4% full scale max. for output value at 25°C in ambient range of -10° to 55°C (14° to 131°F)
Variation due to voltage changes		±2% full scale max. over operating voltage range of 10.8 to 26.4 VDC
Indicators		SENSING (red LED)
Materials		Plastic case
Mounting		Side surface mount with two through holes. E39-L52 bracket and mounting hardware supplied.
Connections		Cable, 2 m (6.6 ft) length, supplied
Weight		130 g (4.6 oz.)
Enclosure ratings	UL	—
	NEMA	2
	IEC 144	IP66
Approvals	UL	—
	CSA	—
Ambient operating temperature		-10° to 55°C (14° to 131°F)

■ AMPLIFIER E4DA-WL1C

Supply voltage		12 to 24 VDC	
Operating voltage		10.8 to 26.4 VDC; ripple 10% max. peak-to-peak	
Current consumption		200 mA	
Response time		2 ms	
External gate input	Type	No-voltage contact or NPN solid-state input	
	Signal voltage level	ON: 0 to 1 V, 1 mA minimum OFF: 4 to 24 V, 15 mA max. or open between terminals	
Control outputs	Analog	Range	4 to 20 mA, 300 Ω max. load impedance
		Linearity	±1% full scale max.
	ON/OFF	Number	Three (HIGH, PASS, LOW)
		Type	Optoisolated transistor outputs
		Rating	80 mA, 30 VDC max.
		Residual voltage	1 V max.
	Alarm	Number	One
		Type	Optoisolated transistor output
		Rating	80 mA, 30 VDC max.
		Residual voltage	1 V max.
Materials		Plastic case	
Mounting		Two through holes for surface mounting using M4 screws	
Connection		Screw terminals	
Weight		230 g (8.1 oz.)	
Enclosure ratings	UL	—	
	NEMA	—	
	IEC 144	IP30	
Approvals	UL	—	
	CSA	—	
Ambient operating temperature		-10° to 55°C (14° to 131°F)	

Nomenclature

■ SENSOR AND AMPLIFIER

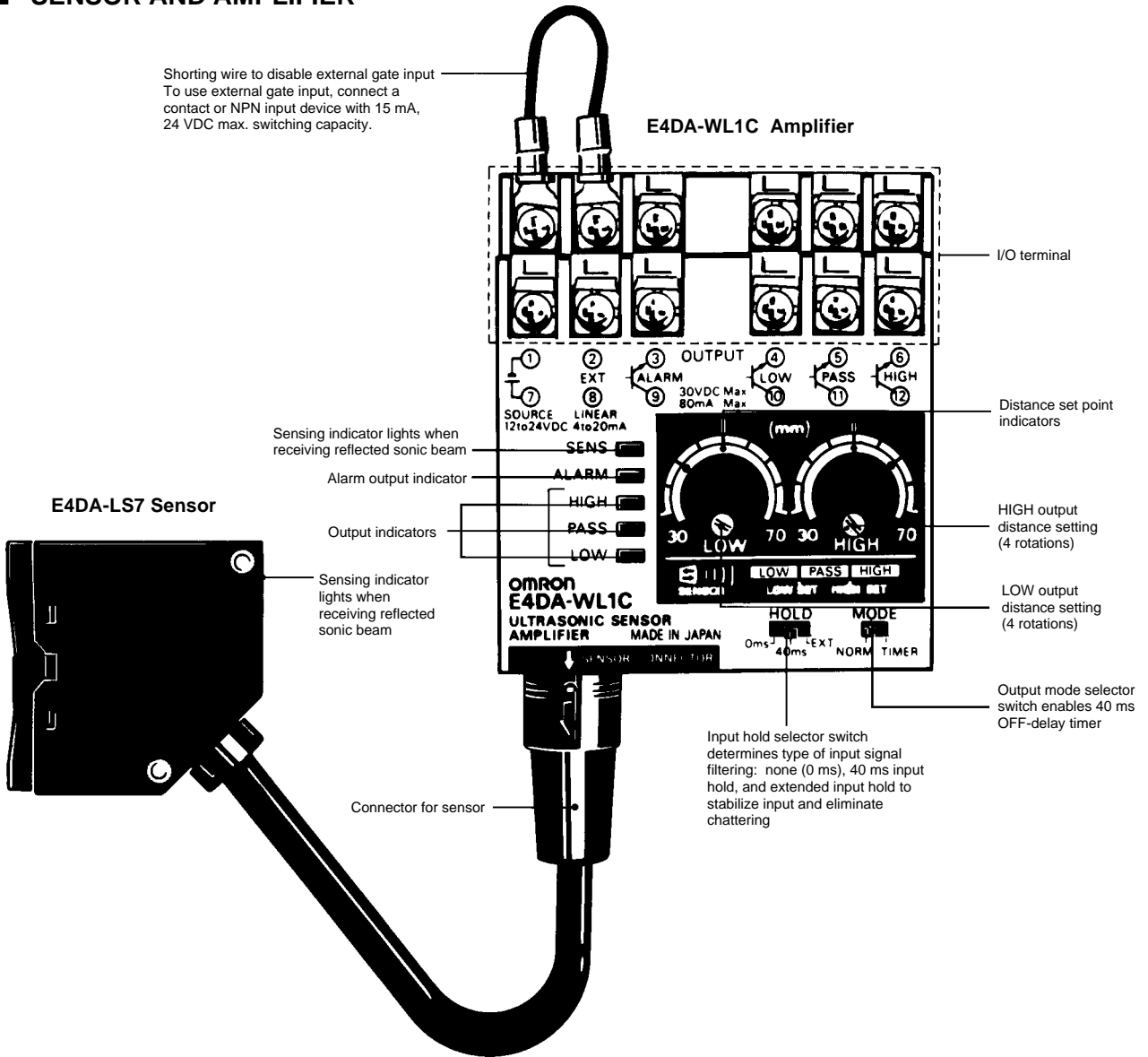

Operation

■ FUNCTIONS — AMPLIFIER

Classification	Function	
O U T P U T S	Linear output	An analog 4 to 20 mA signal will be output from amplifier terminals 2 and 8 according to the distance measured to a target within the 30 to 70 mm measurement range. The output will be locked between 21.8 and 28 mA when the target is beyond the maximum measurement distance. Note: A 10-minute warm-up period is required from power-up to allow the linear output to stabilize.
	High setpoint	The high setpoint output operates according to the high setpoint distance. Rated 80 mA at 30 VDC maximum, the output with indicator is energized when the target measurement distance is 0.2 mm greater than the high setpoint distance.
	Pass setpoint	The pass setpoint output operates according to the high setpoint distance and the low setpoint distance. Rated 80 mA at 30 VDC, the output with indicator is energized when the target measurement distance is less than the high setpoint distance but greater than the low setpoint distance.
	Low setpoint	The low setpoint output operates according to the low setpoint distance. Rated 80 mA at 30 VDC maximum, the output is energized when the target measurement distance is 0.2 mm less than the low setpoint distance.
	Alarm	The alarm output operates according to the 30 mm minimum measurement distance. Rated 80 mA at 30 VDC maximum, the alarm output is energized when the target measurement distance is less than the 30 mm
I N D I C A T O R S	Sensitivity (amplifier and sensor)	The sensitivity indicator illuminates when the sensor's receiver is detecting a reflected sonic beam off the target.
	Alarm	The alarm indicator illuminates when the target measurement distance is less than the 30 mm minimum measurement distance but greater than the 26 mm uncertain operation measurement distance.
	High range	The high range indicator illuminates at the same time the high setpoint output is on.
	Pass range	The pass range indicator illuminates at the same time the pass setpoint output is on.
	Low range	The low range indicator illuminates at the same time the low setpoint output is on.
I N P U T	Gate input	The gate input, rated 15 mA at 24 VDC maximum, synchronizes the start of the sonic measurement with the correct position of the target.
A D J U S T M E N T S	High range setpoint dial	Used to adjust the high setpoint measurement distance and control output. The 4-turn potentiometer allows for fine tuning of the distance setting. The reference scale above the dial is labeled 30 to 70 mm and marked in 5 mm increments.
	Low range setpoint dial	Used to adjust the low setpoint measurement distance and control output. The 4-turn potentiometer allows for fine tuning of the distance setting. The reference scale above the dial is labeled 30 to 70 mm and marked in 5 mm increments.
	Mode switch	In the timer position, a 40 ms OFF-delay is added to the 2 ms response time for the pass setpoint output only. The high and low setpoint outputs are disabled during the 40 ms OFF-delay.
	Input hold switch	The input hold function stabilizes target measurement by adding a time delay until the next stabilized sonic input is received. This minimizes output signal chatter due to unstable input signals from rough surfaces of changes in target position.

THREE-STAGE CONTROL OUTPUT

The two variable distance adjusters on the amplifier front panel are used to establish three control output stages from the 4 to 20 mA input signal. Each four-turn adjuster allows fine tuning of the setting. The reference scale above the adjuster is in 5 mm increments. The linear output current is proportional to the distance to the detected object and is independent of the distance settings.

In the example below, the LOW setting is at 40 mm, and the HIGH setting is at 60 mm. The table below summarizes the three output ranges:

LOW range	30 to 39.8 mm
PASS range	40 to 60 mm
HIGH range	60.2 to 70 mm

The 0.2 mm resolution accounts for the decimal figures. The distance from the sensor face to 25 mm is a multiple reflecting range where output is unstable and should not be used. From 26 mm to 30 mm the object is out of detectable range, so an ALARM output occurs.

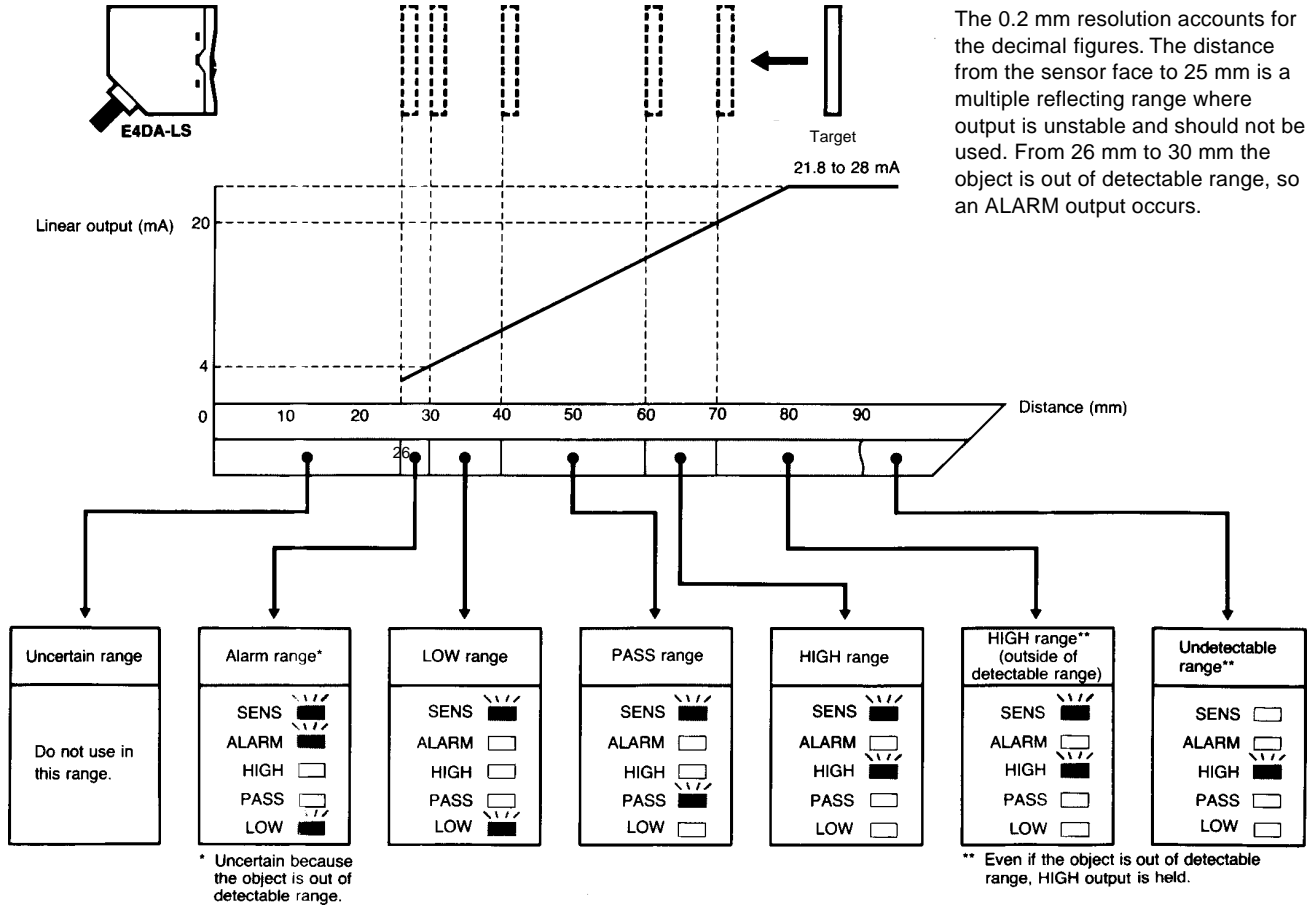

OUTPUT OFF-DELAY FUNCTION

The E4DA amplifier's response time of 2 ms may provide an output signal too fast for a programmable controller to read. The timer function provides a 40 ms OFF-delay that holds only the PASS output for the full duration. The High and Low outputs are disabled and do not operate during the OFF-delay. Whether the gate input is used, or not used, the OFF-delay timer will operate. The output OFF-delay timer is independent of the input HOLD timing.



MODE NORM TIMER	No timer function. Disables OFF-delay timer.
MODE NORM TIMER	40 ms OFF-delay enabled. Holds only the PASS output for the full duration.

INPUT HOLD FUNCTION

When the detected object tilts or when it has a rough surface that absorbs the ultrasonic beam, the E4DA sensor may judge that there is no detected object or the signal has not been returned, causing the output to be unstable (chatter). The input hold function, stabilizes detection by adding a time delay until the next stable input is received.

The three-position slide switch located on the front panel of the amplifier, has settings for 0 ms, 40 ms (for time delay) and EXT for extended delay.

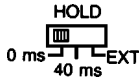

The 0 ms setting disables the input hold function.

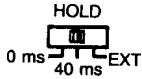

The 40 ms setting enables an internal timer to hold a stable input value for up to 40 ms until a new stable value is input. The hold function is automatically cancelled when a new stable value is input.

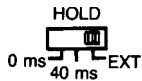

The EXT setting provides an extended hold period until a new stable input value is received.

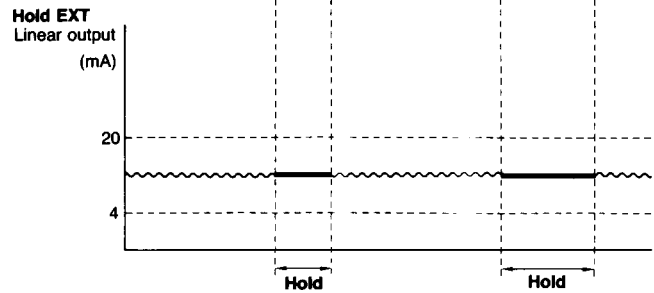
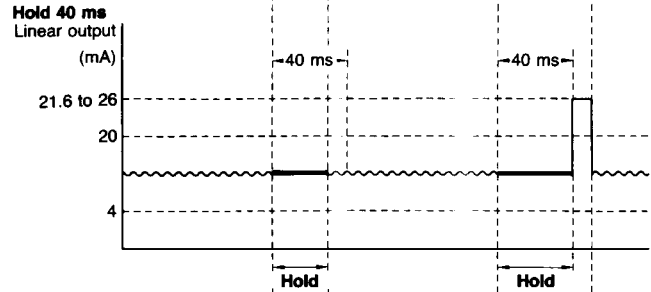
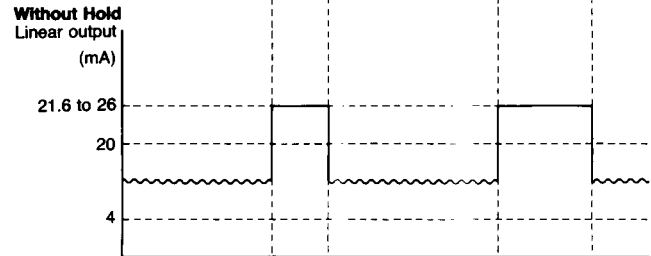
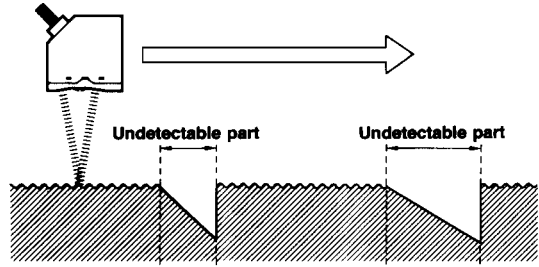

Dimensions

Unit: mm (inch)

■ AMPLIFIER E4DA-WL1C

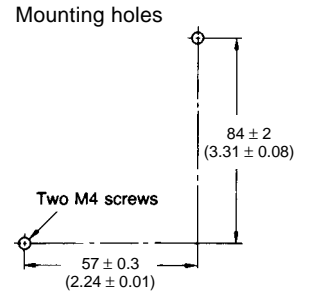
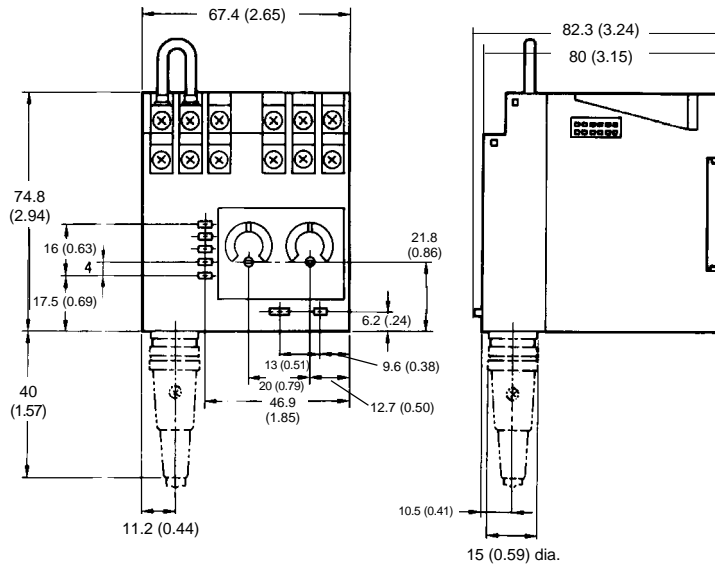
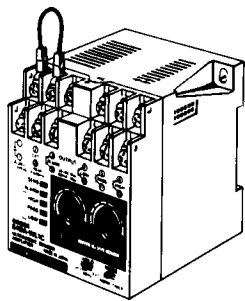

■ SENSOR E4DA-LS7

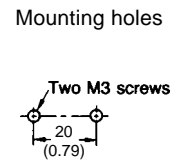
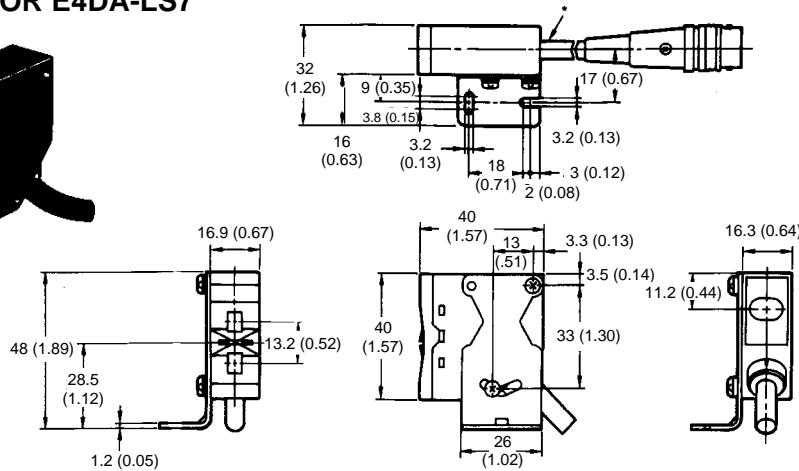
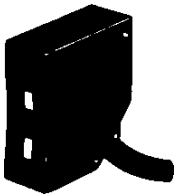

* 2 m (6.56 ft) oil-resistant, vinyl-insulated, shield wire, 6 mm OD

■ OPTIONAL EXTENSION CABLE E49-DD5

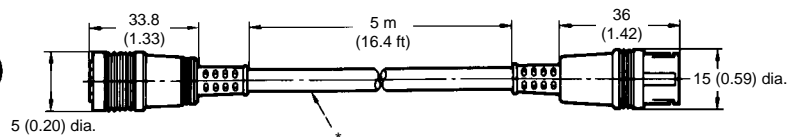

* 5 m (16.4 ft) oil-resistant, vinyl-insulated, round Outside 6 dia. 5 m

Engineering Data

■ LINEAR OUTPUT VS. SENSING DISTANCE

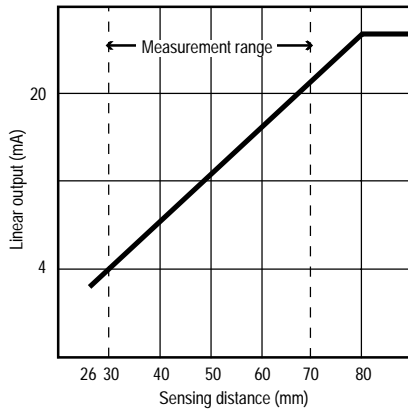

The linear output of the sensor is locked between 21.8 to 28 mA when the target is outside the measurement range. There is no linear output when the target measurement distance is less than 26 mm.

■ MINIMUM DETECTABLE OBJECT

The size of the minimum detected object depends on whether or not a background object is present. To detect a very small object, keep the background at least 40 mm away from the object.

With Background Object

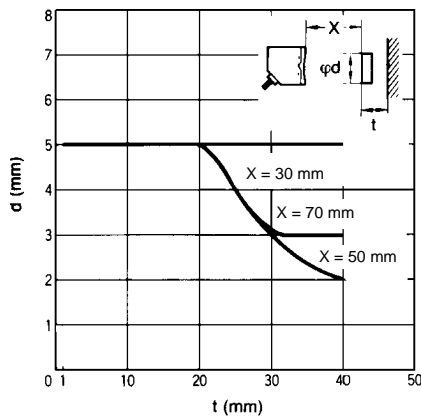

Without Background Object

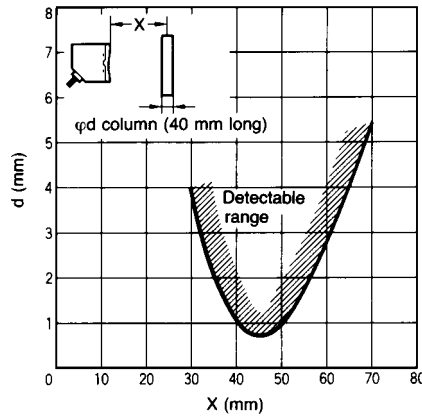

■ OPERATING RANGE

The operating range depends on the target object's direction of approach.

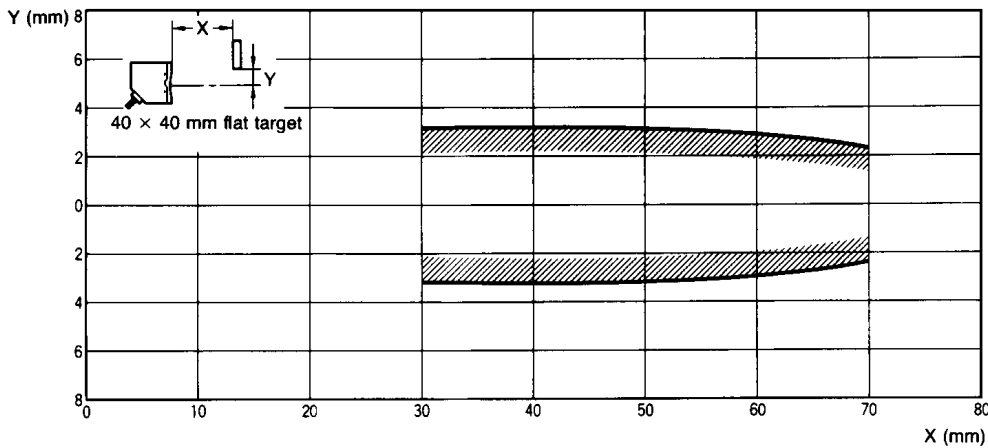

■ DIRECTIONAL ANGLE vs. OPERATING DISTANCE

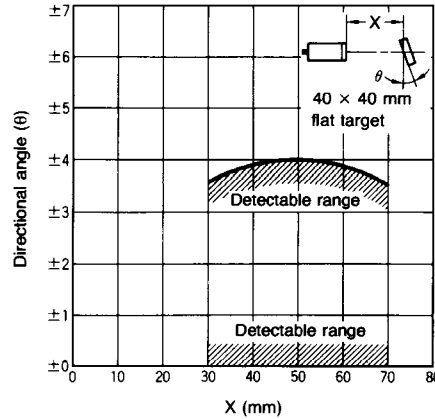
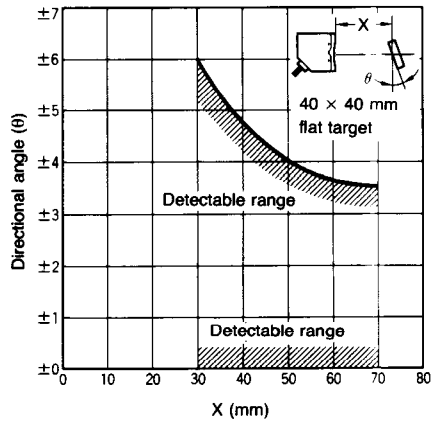

Note :

1. The maximum allowable inclination angle depends on the target object's direction of approach.
2. To reduce the influence of inclination, use the sensor within the detecting distance range of 30 to 50 mm.
3. If surface roughness or unevenness of the detected object affects the operation, use the input hold function described in "Operation" to make the output stable.

■ INFLUENCE OF TEMPERATURE VARIATION

The influence of temperature variation depends on the detecting distance.

Sensor and Amplifier at the Same Temperature

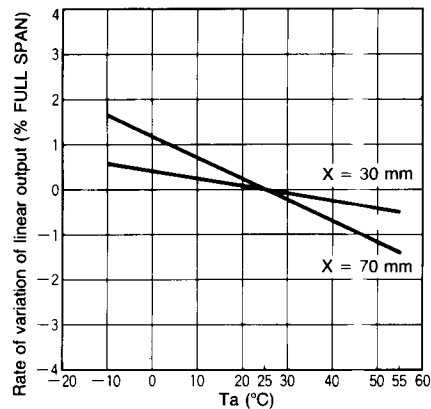

Both sensor and amplifier: same and variable temperature

Sensor at Variable Temperature, Amplifier at 25°C

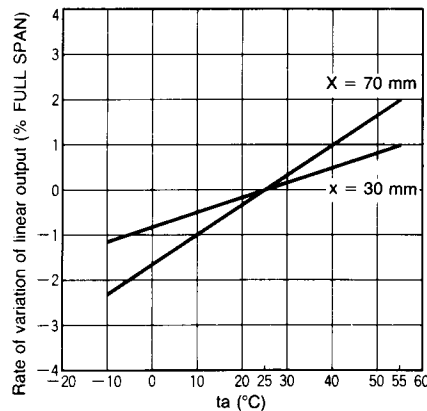

Sensor variable temperature Amplifier constant 25°C

■ DETECTING ROUND OBJECTS

Use the layout below to detect round objects when a background object is present.

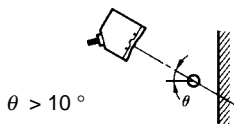

OUTPUT CIRCUIT DIAGRAM

The figures in small circles indicate terminal numbers.

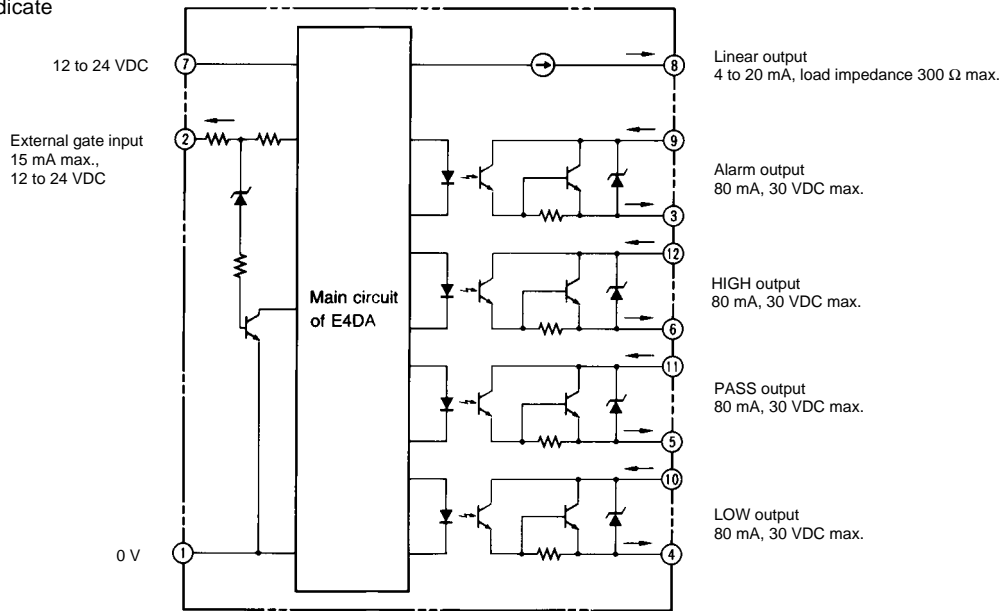

Connections

Terminals 1 and 2 are intentionally shorted. To use an external gate input, connect an external switching device (NPN output sensor or no-voltage contact switch) to terminals 1 and 2.

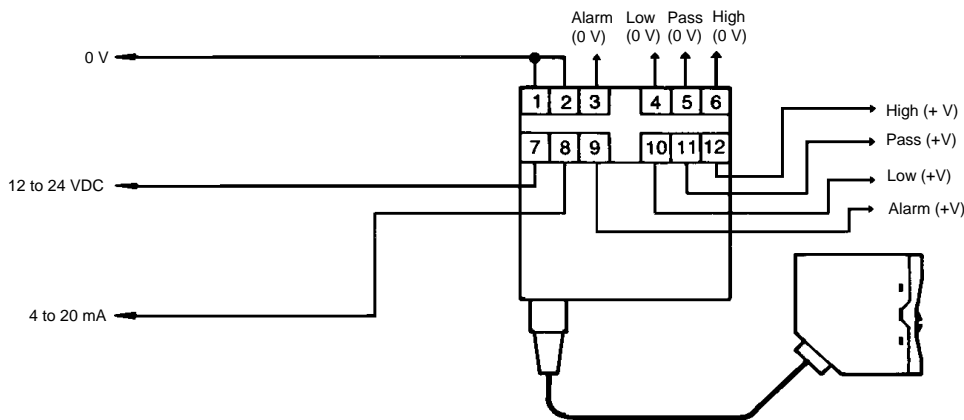

Precautions

INSTALLATION AND MAINTENANCE PRECAUTIONS

Avoid mutual interference by placing sensors side by side, more than 5 mm apart. Mutual interference occurs when the object is inclined or when sensors are mounted opposite one another.

Do not use the sensor in the following environmental conditions that adversely affect the sound wave transmission through the air.

- Locations subject to air convection
- Locations with temperature differences within the sensing area
- Rapid change in air flow within the operating range of the sensor

Ultrasonic sensors may not be capable of detecting sound-absorbent materials, including: cotton, powders, foam, froth, soft porous materials, and so forth.

Condensation or drops of water on the vibrator surface of the ultrasonic sensor may decrease detecting distance.

A 10-minute warm-up period is required from power-up to allow the linear output to stabilize.

Clean dust off the vibrator surface of the sensor using a blast of air or a cotton swab. Do not apply pressure on the vibrator surface.

NOTE: DIMENSIONS ARE SHOWN IN MILLIMETERS. To convert millimeters to inches divide by 25.4.

OMRON ELECTRONICS LLC.

One East Commerce Drive
Schaumburg, IL 60173
1-800-55-OMRON

OMRON ON-LINE

Global - <http://www.omron.com>
USA - <http://www.omron.com/oei>
Canada - <http://www.omron.com/oci>

OMRON CANADA, INC.

885 Milner Avenue
Scarborough, Ontario M1B 5V8
416-286-6465