

ターミナル及びリテーナー装着状態図
TERMINAL AND RETAINER ASSEMBLY DRAWING

注記 NOTES

- △ 適合ターミナル：50752-8*00
APPLICABLE TERMINAL : 50752-8*00
- △ 適合リテーナー：51164-**05
APPLICABLE RETAINER : 51164-**05
- 3. 嵌合相手：53375,53376,53388,53389,53426 シリーズ
MATE WITH : 53375,53376,53388,53389,53426 SERIES
- △ 偶数極の製品に適用。
APPLY EVEN CIRCUIT PRODUCTS.

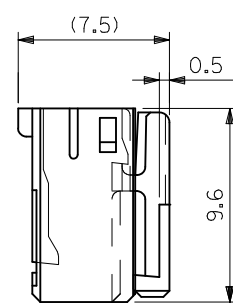
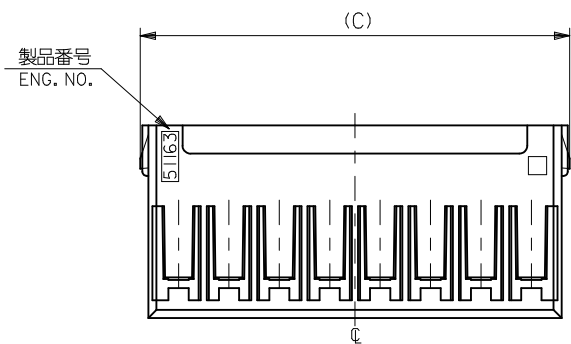

3-15 極に適用
FOR 3-15 CKTS.

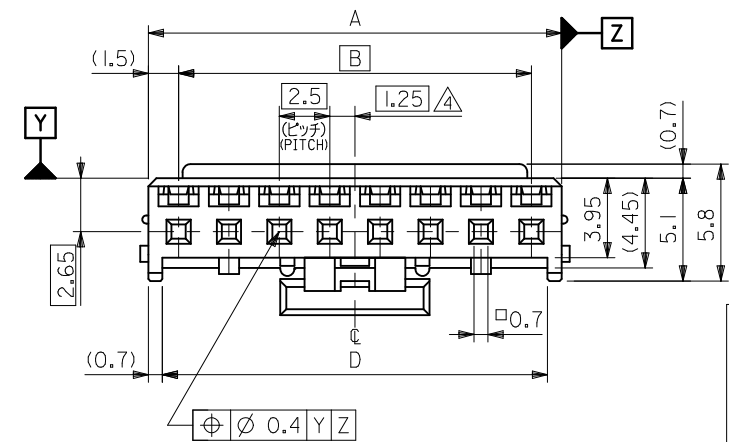

						青 BLUE	赤 RED	黒 BLACK	白 NATURAL	COLOR	
12.5	7.4	5	36.6	38.8	35	38	51163-1504	51163-1502	51163-1501	51163-1500	15
12.5			34.1	36.3	32.5	35.5	-1404	-1402	-1401	-1400	14
12.5			31.6	33.8	30	33	-1304	-1302	-1301	-1300	13
12.5			29.1	31.3	27.5	30.5	-1204	-1202	-1201	-1200	12
12.5			26.6	28.8	25	28	-1104	-1102	-1101	-1100	11
12.5			24.1	26.3	22.5	25.5	-1004	-1002	-1001	-1000	10
12.5			21.6	23.8	20	23	-0904	-0902	-0901	-0900	9
12.5			19.1	21.3	17.5	20.5	-0804	-0802	-0801	-0800	8
			16.6	18.8	15	18	-0704	-0702	-0701	-0700	7
			14.1	16.3	12.5	15.5	-0604	-0602	-0601	-0600	6
			11.6	13.8	10	13	-0504	-0502	-0501	-0500	5
	7.4	5	9.1	11.3	7.5	10.5	-0404	-0402	-0401	-0400	4
	5	3	6.6	8.8	5	8	51163-0304	51163-0302	51163-0301	51163-0300	3
G	F	E	D	(C)	B	A	MATERIAL NO.	MATERIAL NO.	MATERIAL NO.	MATERIAL NO.	NO. OF CKT

REVISED EC NO: J2005-1394 DRWN: JSASAMOR CHKDK: TOJO APPR: NUKITA 2004/11/09 2004/11/10 2004/11/18	DESCRIPTION GENERAL TOLERANCES (UNLESS SPECIFIED) 10 UNDER ±0.2 10 OVER 30 UNDER ±0.25 30 OVER ±0.3 ANGULAR ±3 ° DRAFT WHERE APPLICABLE MUST REMAIN WITHIN DIMENSIONS	DIMENSION STYLE MM ONLY	SCALE 4:1	DESIGN UNITS METRIC	THIRD ANGLE PROJECTION	
		DRAWN BY J. SASAMO	DATE 2004/8/31	TITLE 2.5 WIRE TO BORAD CONN. HOUSING (POSITIVE LOCK) WITH RETAINER		
		CHECKED BY K. TOJO	DATE 2004/8/31	MOLEX MOLEX INCORPORATED		
		APPROVED BY N. UKITA	DATE 2004/8/31	MATERIAL NO. 51163-**0*	DOCUMENT NO. SD-51163-001	SHEET NO. 1 OF 2

MATERIAL
PBTP, UL94V-0
SEE CHART

10 9 8 7 6 5 4 3 2 1

トレードマーク
TRADE MARK
回路番号 1
CIRCUIT NO.1

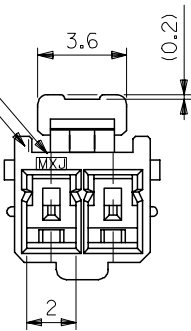

製品番号
ENG. NO.

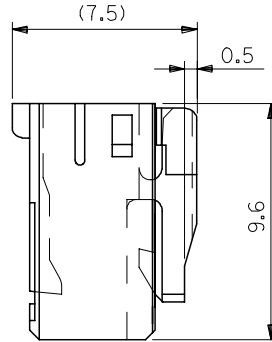
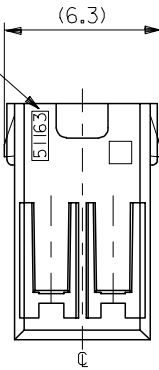

注記 NOTES

- △ 適合ターミナル : 50752-8*00
APPLICABLE TERMINAL : 50752-8*00
- △ 適合リテーナー : 51164-***05
APPLICABLE RETAINER : 51164-***05
- 3. 嵌合相手 : 53375,53426 シリーズ
MATE WITH : 53375,53426 SERIES

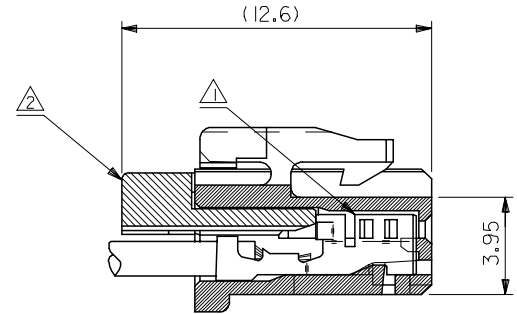

ターミナル及びリテーナー装着状態図
TERMINAL AND RETAINER ASSEMBLY DRAWING

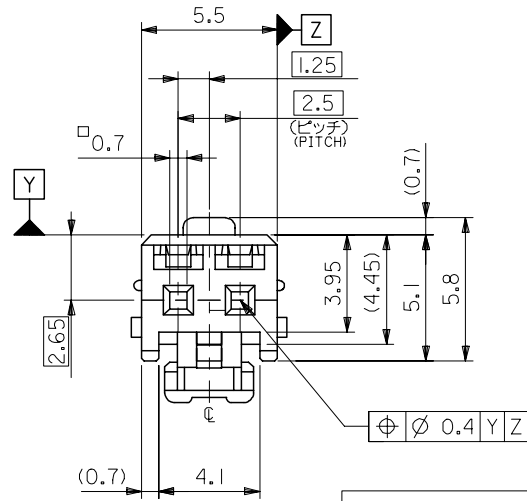

2 極に適用
FOR 2 CKTS.

青	BLUE	51163-0204	2
赤	RED	51163-0202	
黒	BLACK	51163-0201	
白	NATURAL	51163-0200	
COLOR MATERIAL NO.		MATERIAL NO.	NO. OF CKT.

MATERIAL
PBTP, UL94V-0
SEE CHART

REVISED EC NO: J2005-1394 DRWN: SASAMOR 2004/11/09 CHKDK: TOJO 2004/11/10 APPR: NUKITA 2004/11/18 A	GENERAL TOLERANCES (UNLESS SPECIFIED)		DIMENSION STYLE MM ONLY		SCALE 5:1	DESIGN UNITS METRIC	THIRD ANGLE PROJECTION	
	10 UNDER	±0.2	DRAWN BY J. SASAMO	DATE 2004/8/31	TITLE 2.5 WIRE TO BORAD CONN. HOUSING (POSITIVE LOCK) WITH RETAINER			
	10 OVER 30 UNDER	±0.25	CHECKED BY K. TOJO	DATE 2004/8/31				
	30 OVER	±0.3	APPROVED BY N. UKITA	DATE 2004/8/31	MOLEX INCORPORATED			
ANGULAR	±3 °	MATERIAL NO. 51163-***0*	DOCUMENT NO. SD-51163-001	SHEET NO. 2 OF 2				
DRAFT WHERE APPLICABLE MUST REMAIN WITHIN DIMENSIONS		THIS DRAWING CONTAINS INFORMATION THAT IS PROPRIETARY TO MOLEX INCORPORATED AND SHOULD NOT BE USED WITHOUT WRITTEN PERMISSION						