

DETAILS

Product Number	FCN13595_CRYSTAL-MINE
Family	Crystal
Type	Pack
Color	white
Diameter	50,3 mm
Height	28,7 mm
Style	round
Optic Material	PMMA
Holder Material	
Fastening	pin, screw
Status	production ready
ROHS Compliant	Yes
Date Updated	16/12/2016



OPTICAL PROPERTIES

LED	Viewing	Light	Efficiency	cd/lm	Connector
	Angle	Beam			
XP-G	4.7 deg	Spot	90 %	66.900	-
XM-L2	6.9 deg	Spot	90 %	35.000	-
XP-G2	4.6 deg	Spot	90 %	65.200	-
XP-L	7 deg	Spot	86 %	33.000	-
XP-L HI	4.5 deg	Spot	92 %	60.000	-
XHP35 HI	sim: 6,2	Spot	sim: 94 %	sim: 50.400-	
XHP35 HD	sim: 7,8	Spot	sim: 94 %	sim: 28.600-	
LUXEON A	4.9 deg	Spot	89 %	58.200	-
LUXEON T	4.9 deg	Spot	89 %	55.100	-
LUXEON TX	5.0 deg	Spot	94 %	50.600	-
NCSxx19B	3,6 deg	Spot	90 %	73.300	-
NWSx229A	7 deg	Spot	91 %	26.000	-
NV4x144A	11 deg	Spot	90 %	13.400	-
NVSxx19B/NVSxx19C	6 deg	Spot	93 %	48.000	-
LH351Z	4.2 deg	Spot	90 %	71.400	-
LH351B	5.1 deg	Spot	90 %	51.770	-
Z8Y22P	sim: 7,8	Spot	sim: 94 %	sim: 29.900-	

Relative intensity of CN13595_CRYSTAL-MINE_(XM-L2)

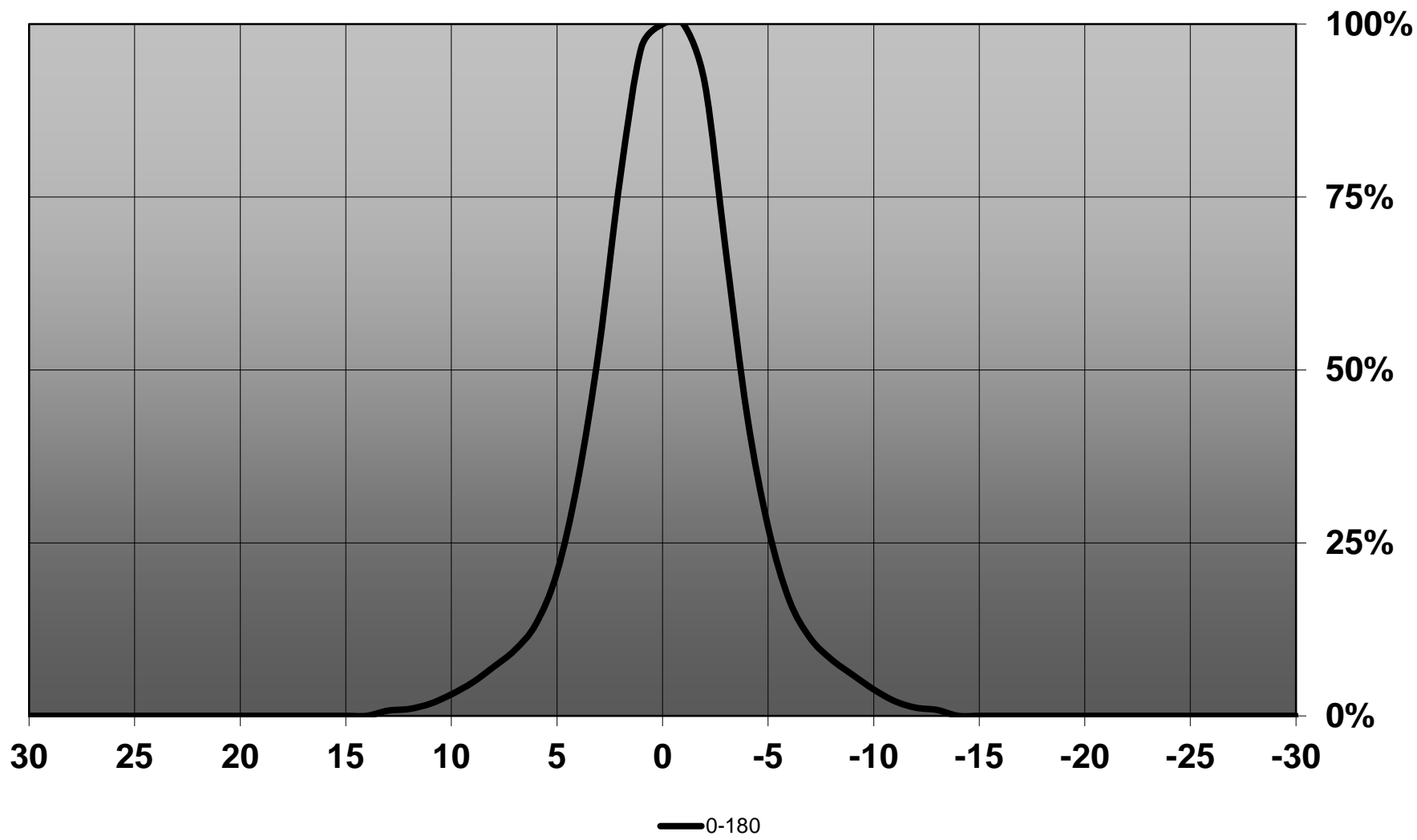

Relative intensity of CN13595_CRYSTAL-MINE_(XP-G2)

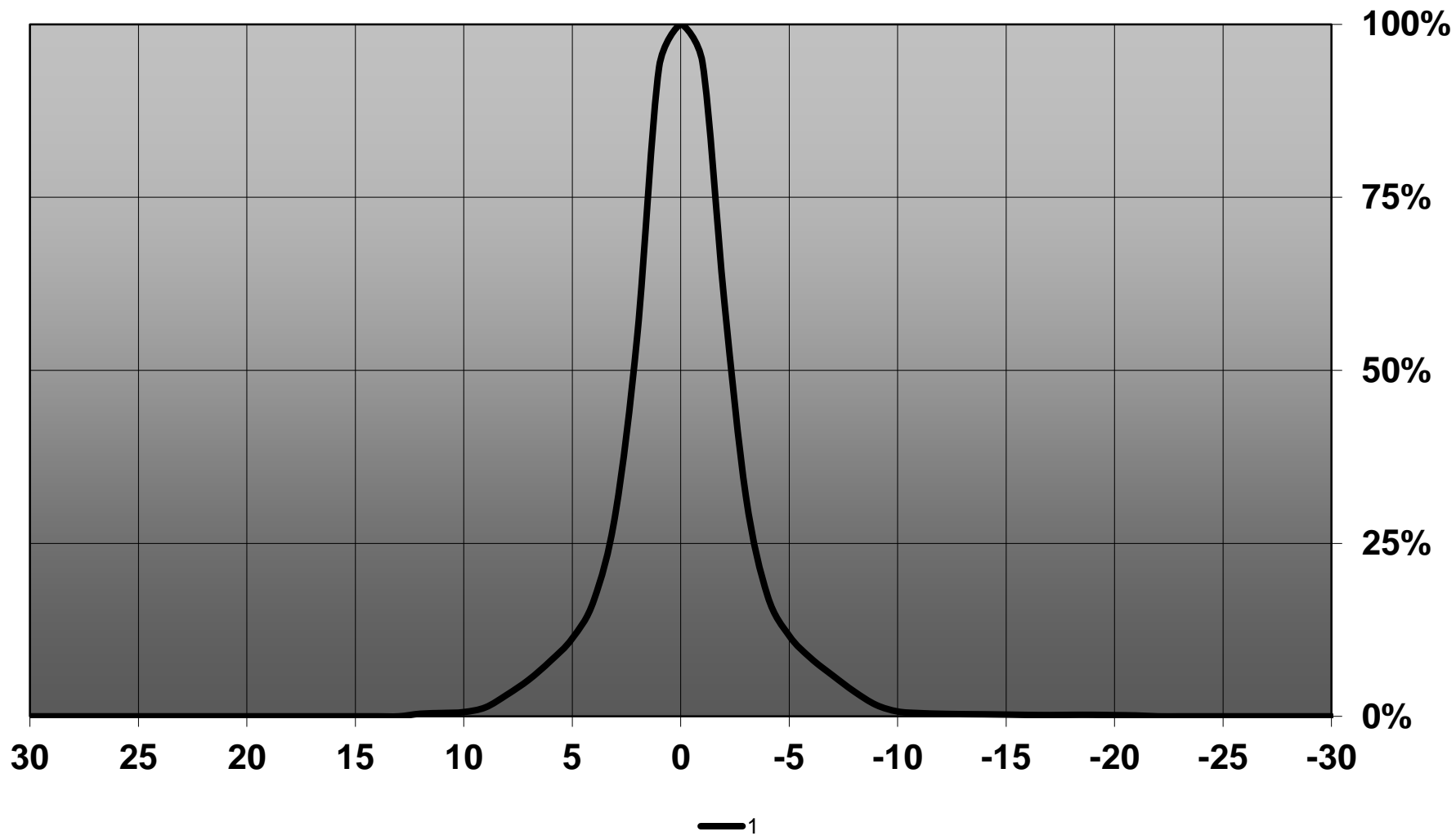

Relative intensity of CN13595_CRYSTAL-MINE_(Luxeon_A)

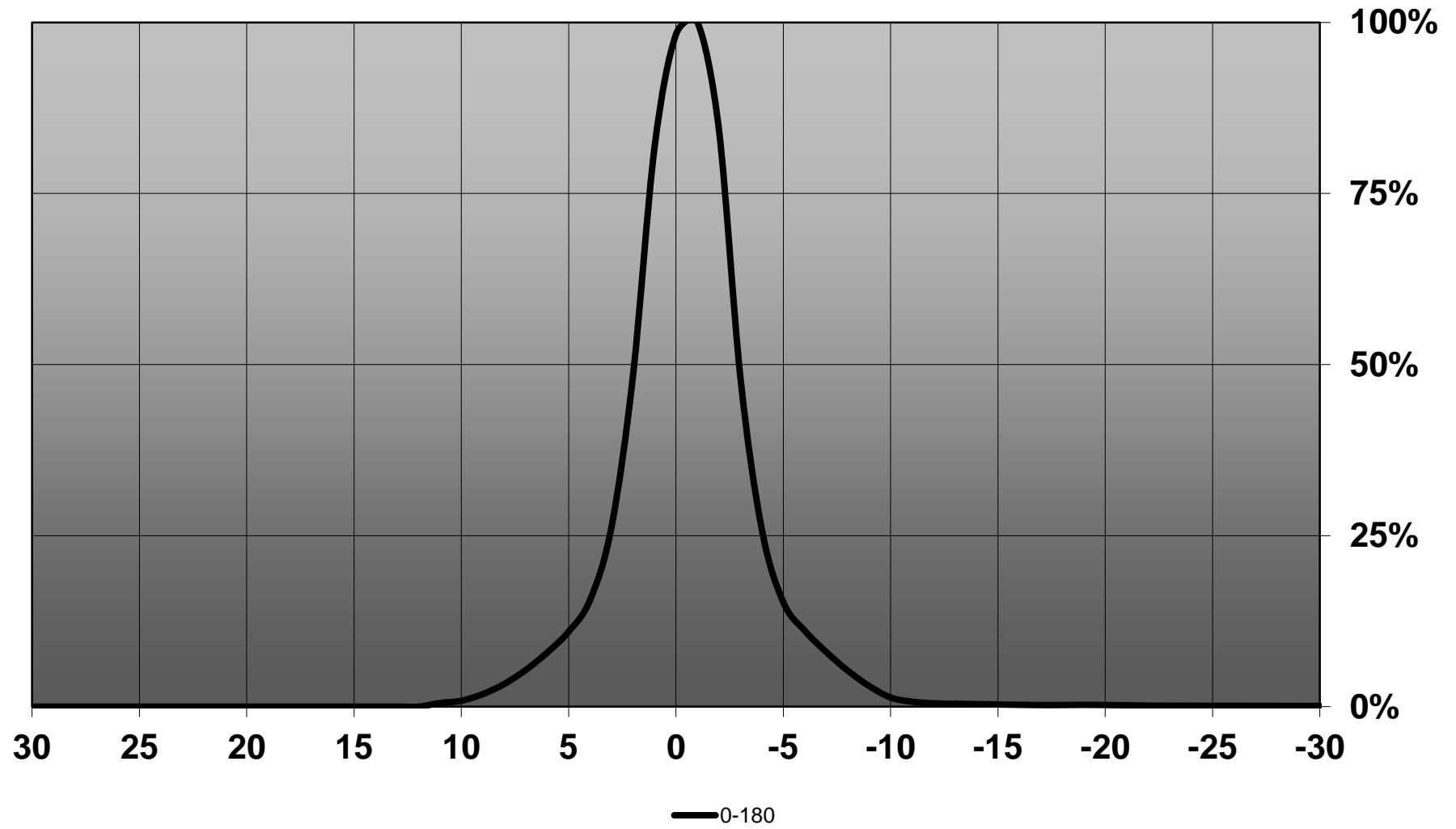

Relative intensity of CN13595_CRYSTAL-MINE_(Luxeon_T)

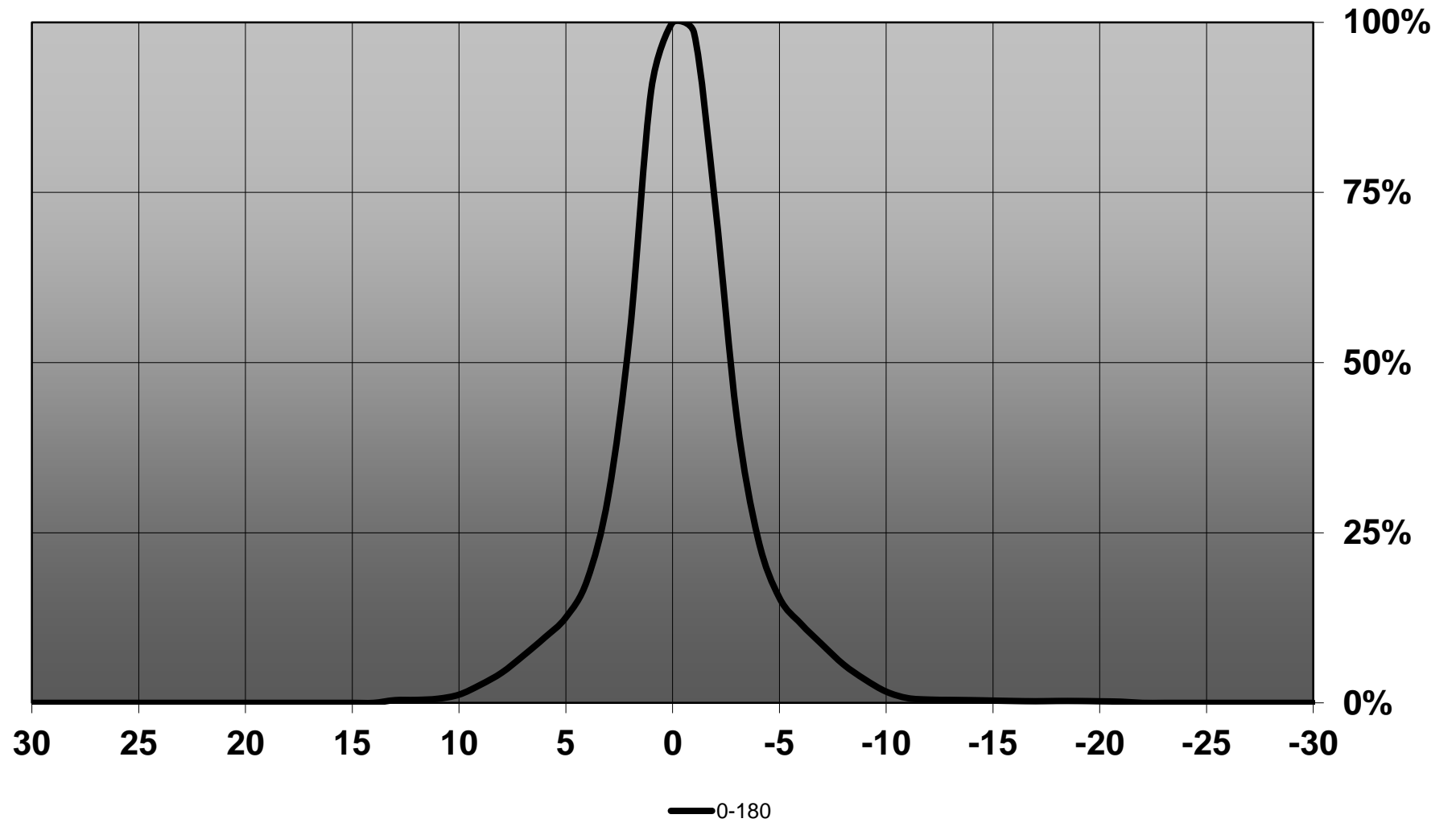

Relative intensity of CN13595_CRYSTAL-MINE_(NCSxx19B)

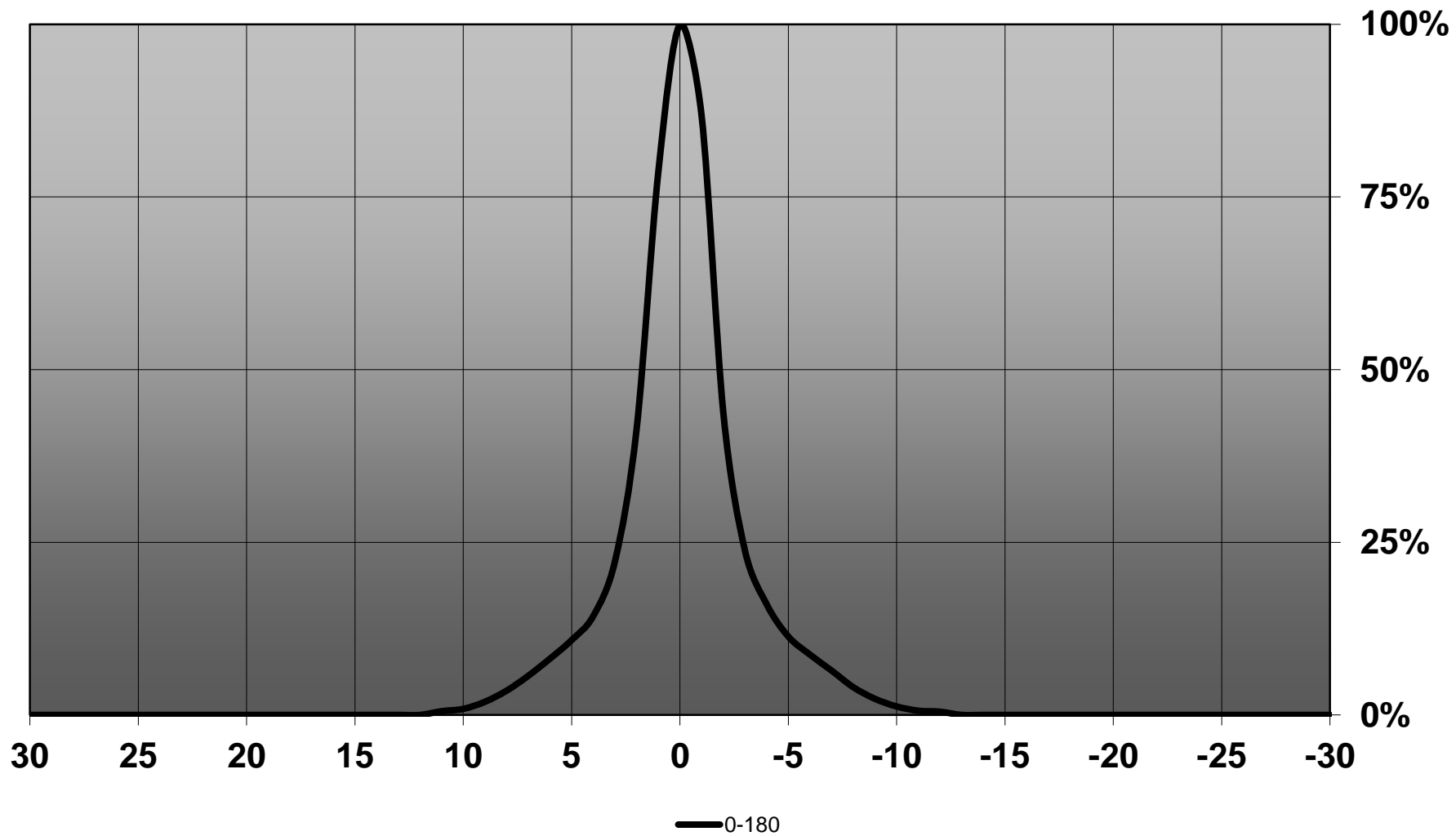

Relative intensity of CN13595_CRYSTAL-MINE_(LH351Z)

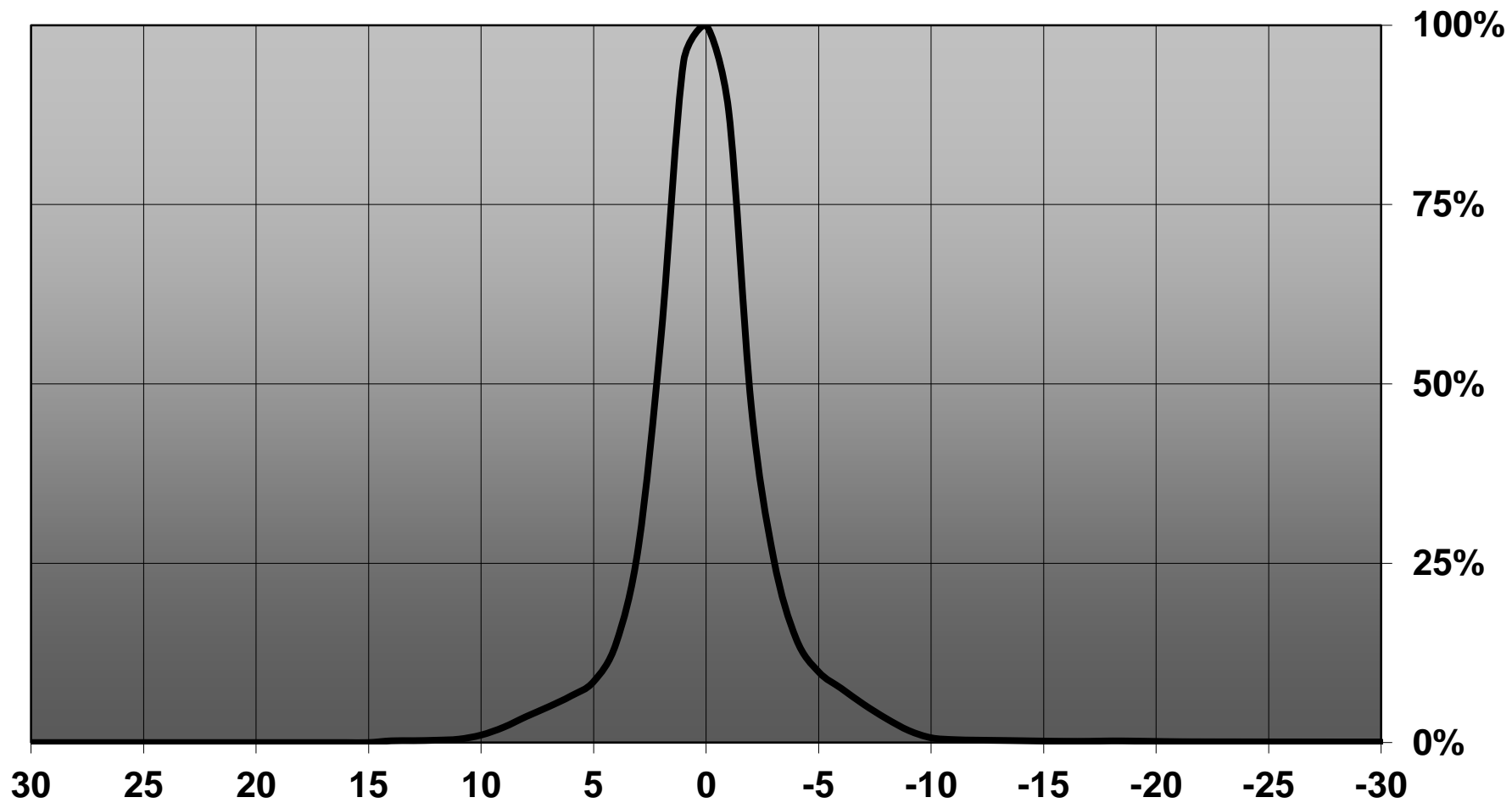

— 1: 0-180

Relative intensity of CN13595_CRYSTAL-MINE_(LH351B)

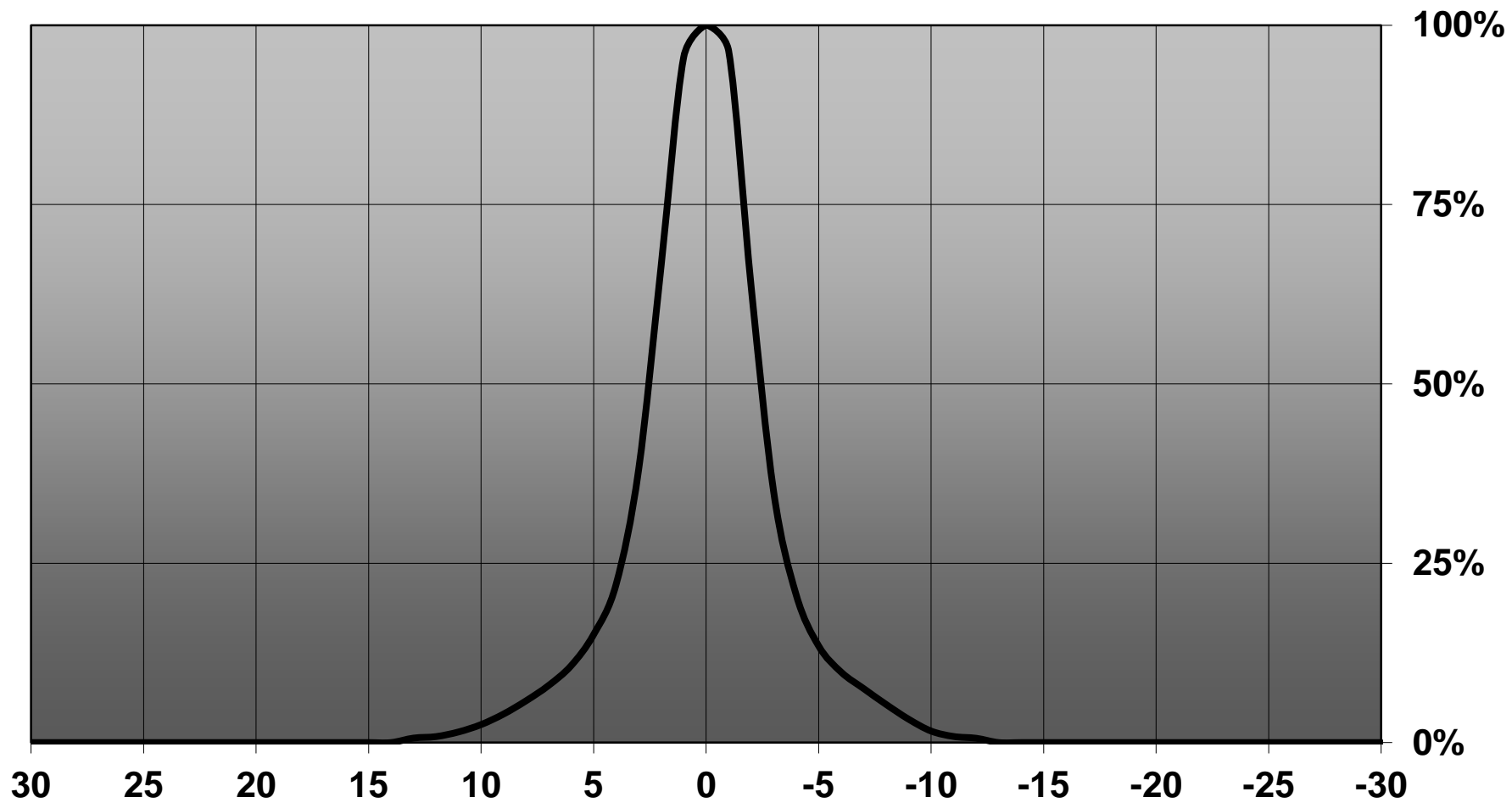

D

C

B

A

4

4

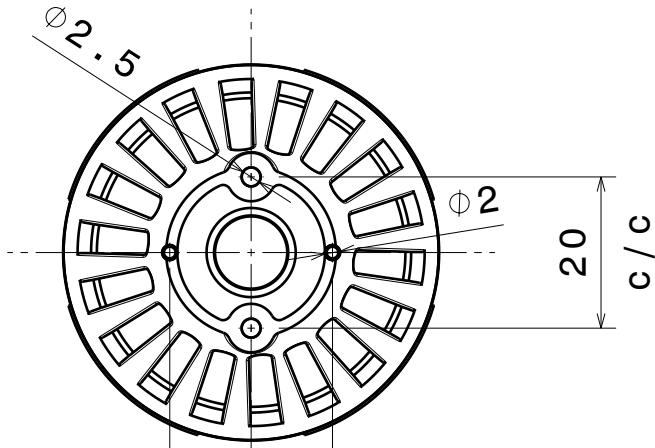

Bottom view

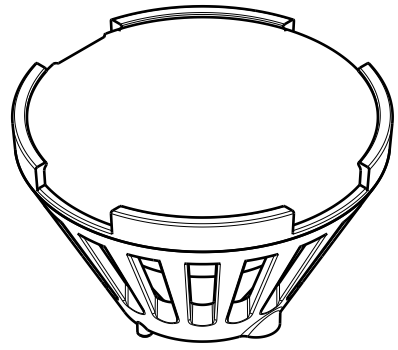

3

3

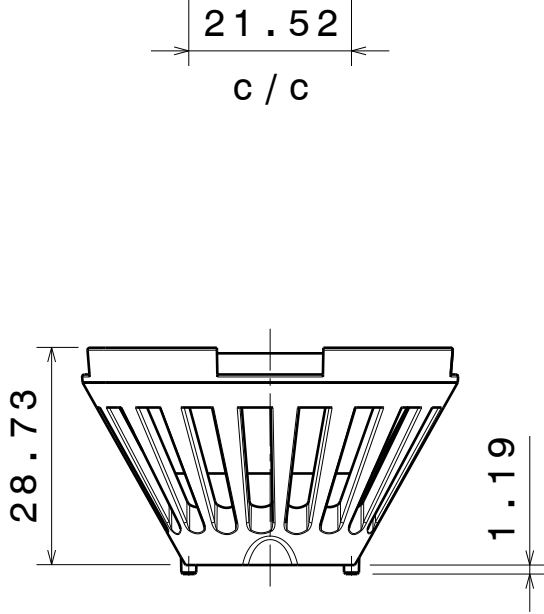

Front view

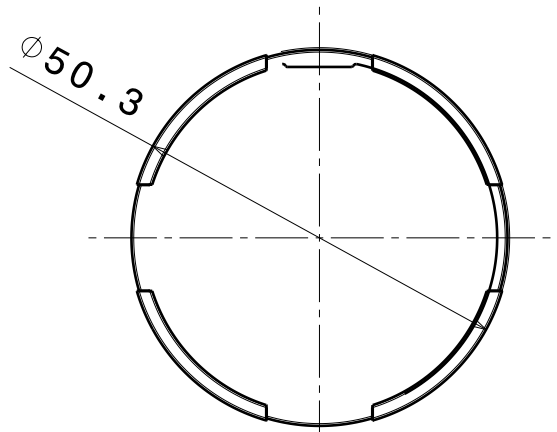

Top view

2

2

Tolerances if not otherwise shown
 According to DIN ISO 2768-1
 Linear measures: class C
 According to DIN ISO 2768-2
 Form and position: class L



Ledil Oy
 Salorankatu 10
 FIN 24240 SALO
 Finland

THIRD ANGLE PROJECTION:

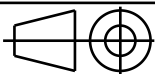

DRAWING TITLE

Crystal Assembly MechDrawing

This drawing is the property
 of LEDiL Oy. It may not be
 reproduced, copied or
 communicated without a written
 agreement with LEDiL Oy.

SIZE PART NUMBER

A4

-

SCALE 1:1 WEIGHT

-

SHEET 1/1

D

A

1

1

Ledil CN13595_CRYSTAL-MINE_(XP-L) / LDC (Linear)

Luminaire: Ledil CN13595_CRYSTAL-MINE_(XP-L)
Lamps: 1 x CREE_XP-L_(XPLAWT-0-7A3-U50-0H-0001)
_107.852lm@250mA_CCT=3185K_P=0.7W_I=0.25A

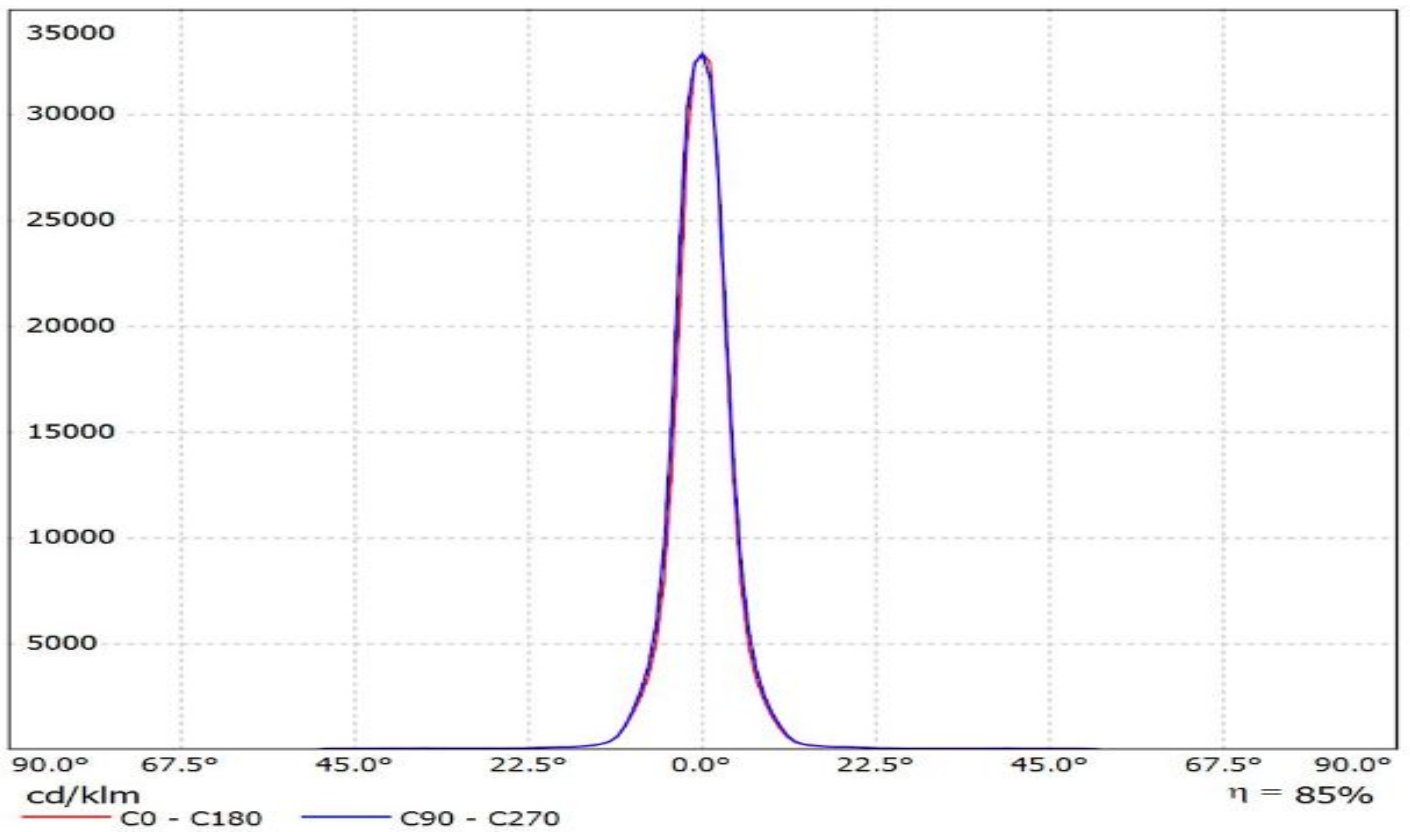

Ledil CN13595_CRYSTAL-MINE_(XP-L_HI) / LDC (Linear)

Luminaire: Ledil CN13595_CRYSTAL-MINE_(XP-L_HI)
Lamps: 1 x Cree_XP-L_HI_21.6891lm@250mA_P=0.13W_I=0.05A

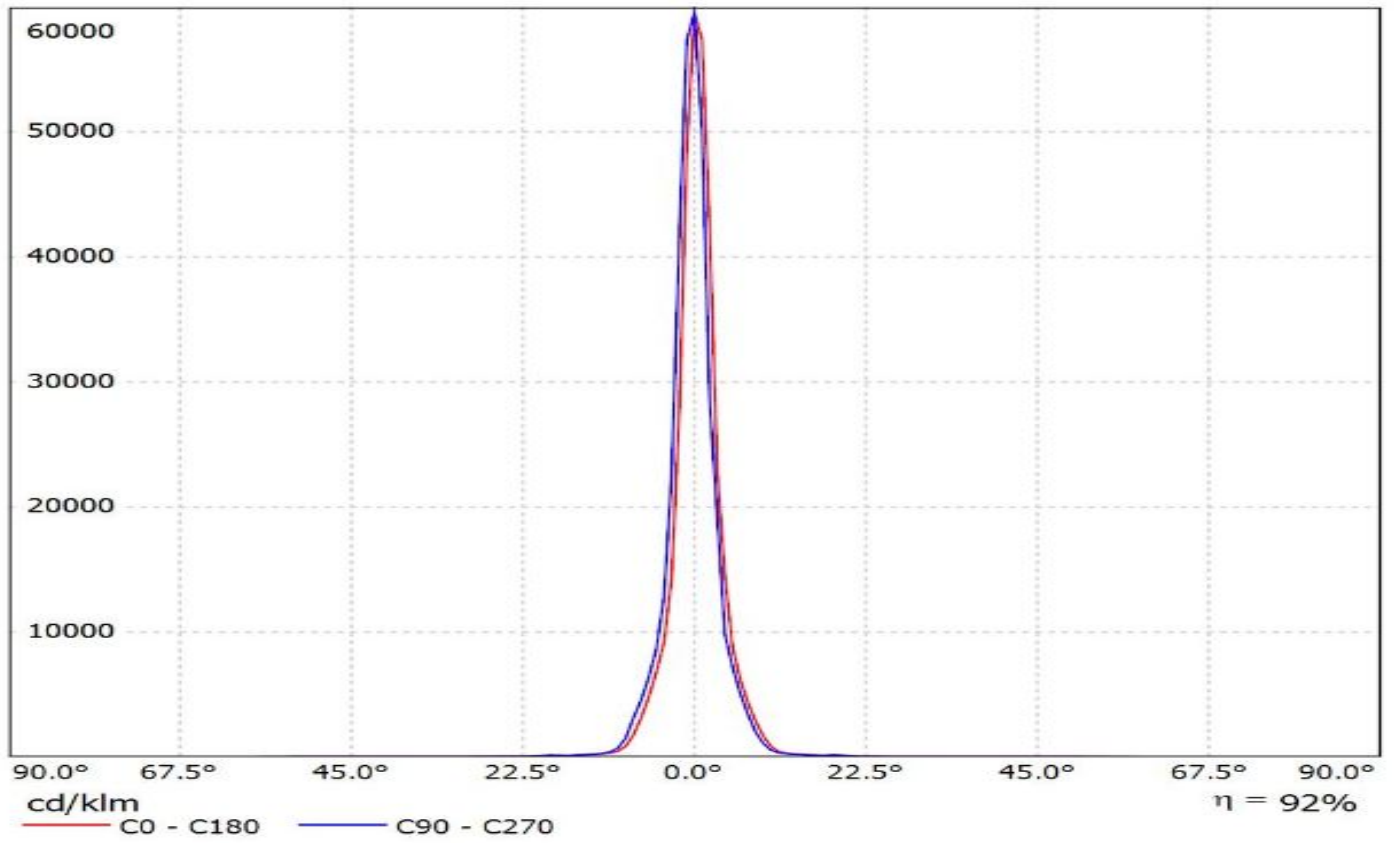

Luminaire: Ledil Oy FCN13595_CRYSTAL-MINE_(XHP35_HI)_SIMULATED
Lamps: 1 x Cree XHP35 HI

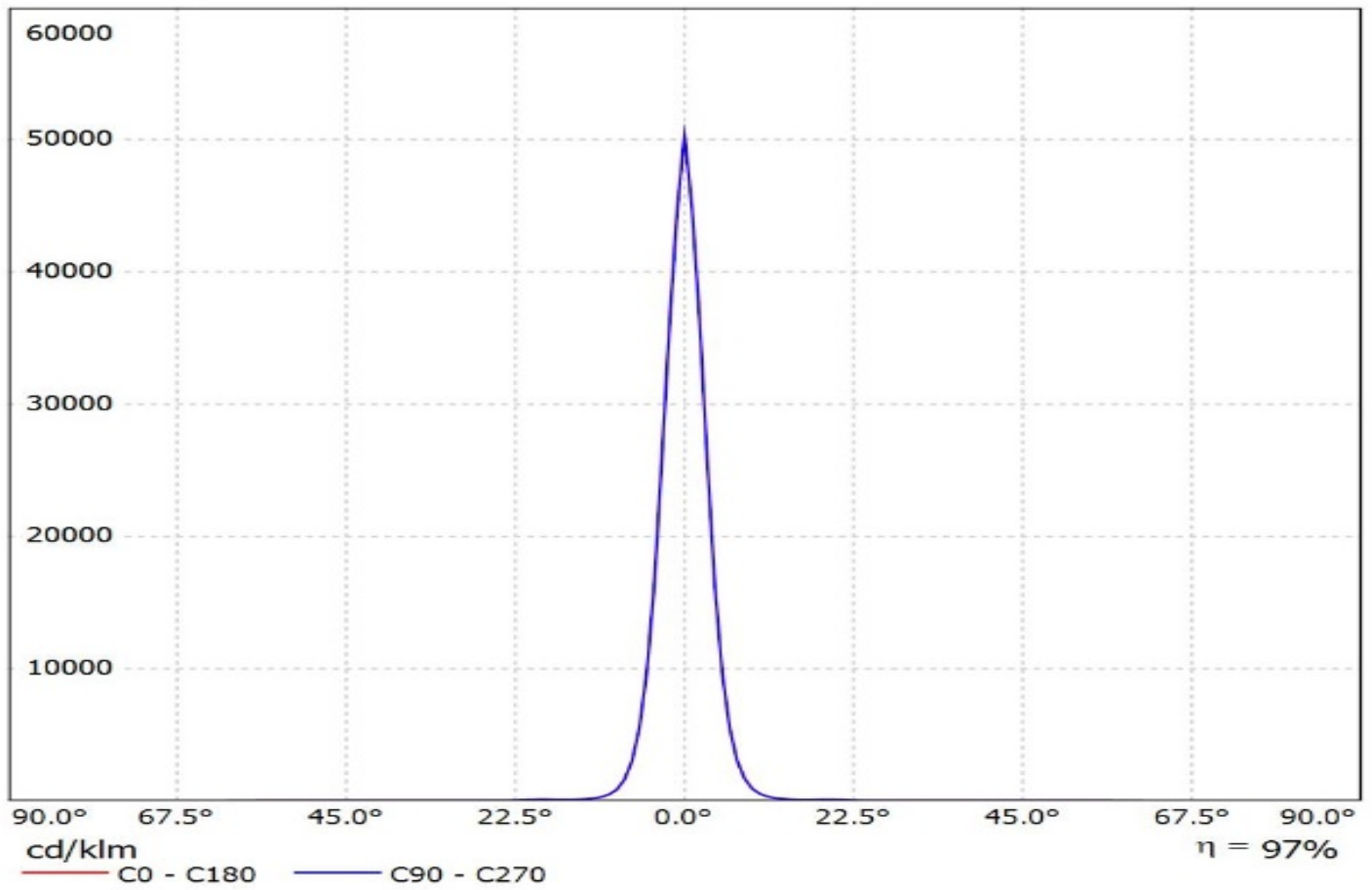

Luminaire: Ledil Oy FCN13595_CRYSTAL-MINE_(XHP35_HD)_SIMULATED
Lamps: 1 x Cree XHP35 HD

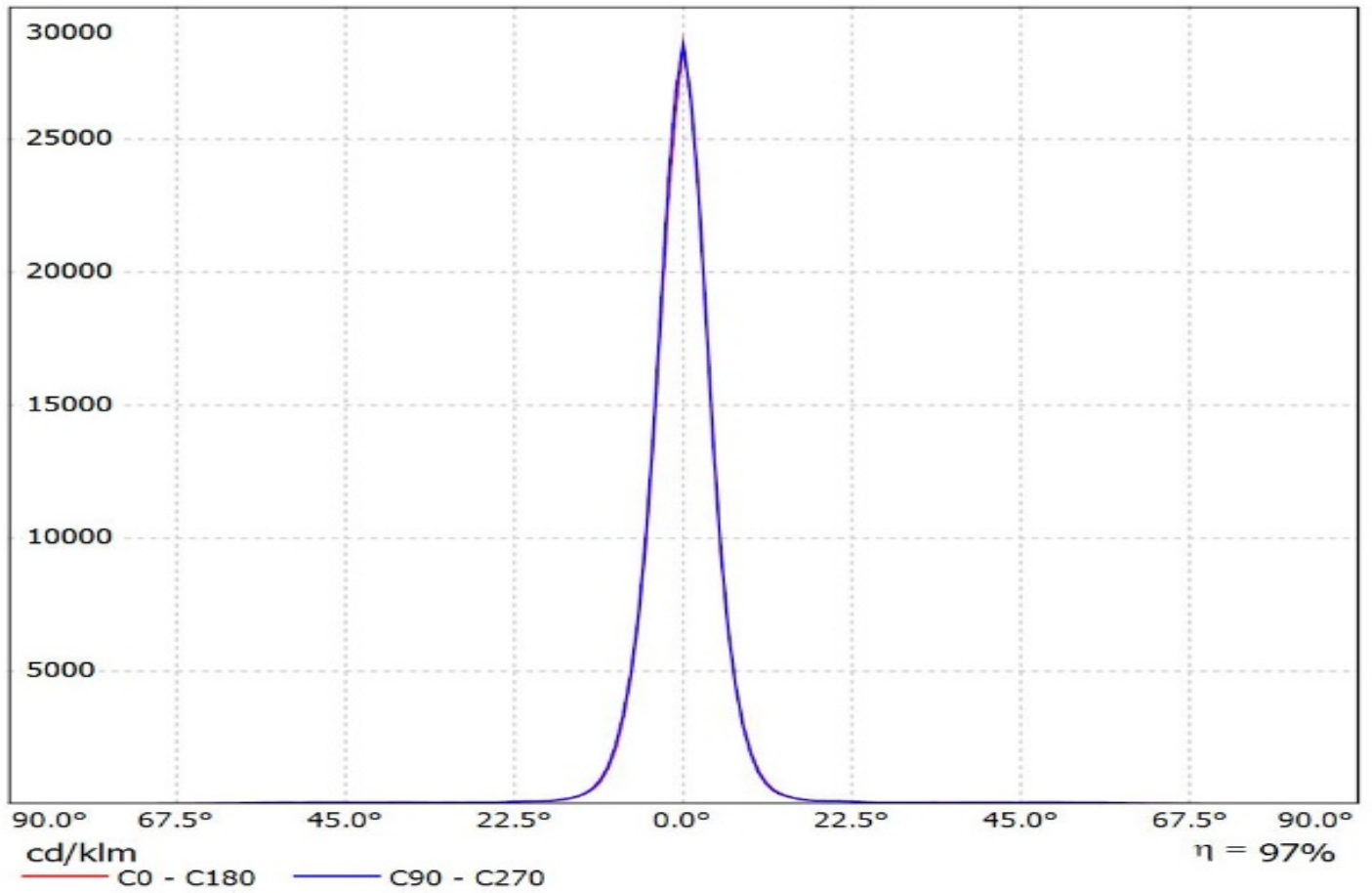

Luminaire: LEDiL Oy CN13595_CRYSTAL-MINE_(Luxeon_TX)

Lamps: 1 x Philips_Lumileds_Luxeon_TX_(L1T2-3585)_79.5244lm@250mA_CCT=3554K_P=0.740729W_I=0.2499A

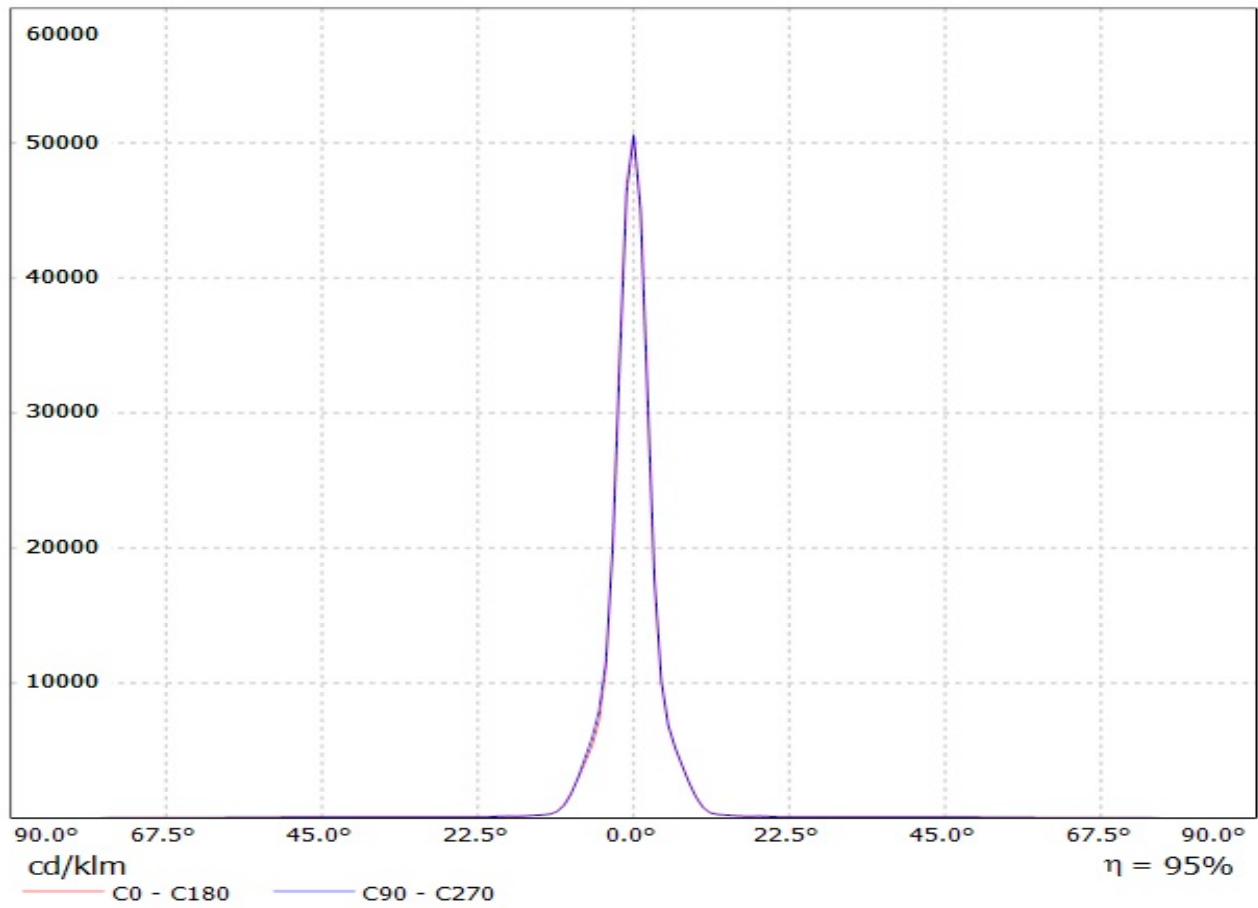

Luminaire: Ledil Oy FCN13595_CRYSTAL-MINE_(NCSxx19B)_SIMULATED
Lamps: 1 x Nichia NCSxx19B (NCSW219B)

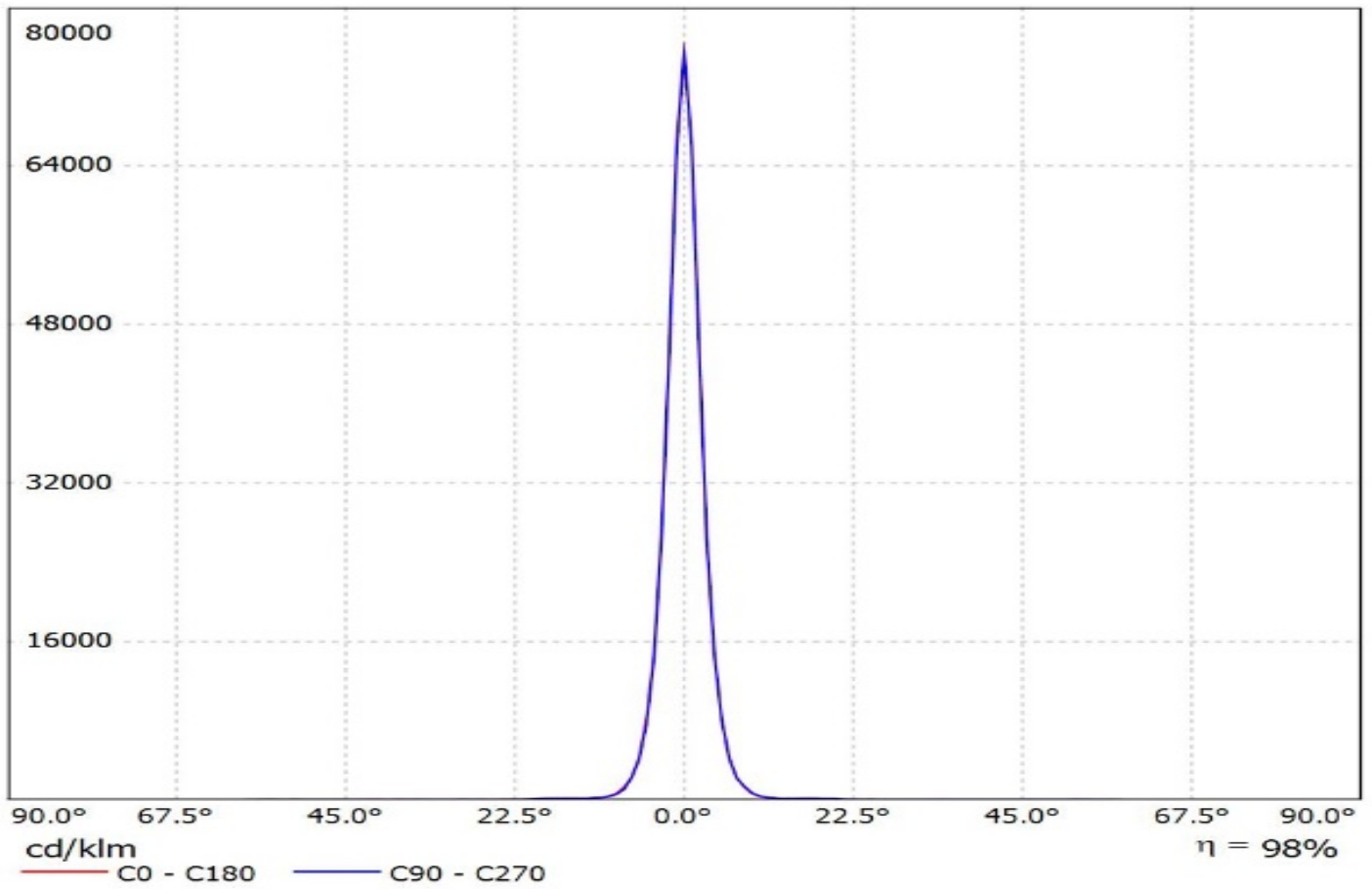

Luminaire: LEDiL Oy FCN13595_CRYSTAL-MINE_(NWSL229AE)
Lamps: 1 x Nichia_NWSL229AE_120.514lm@250mA_P=0.7132W_I=0.250A

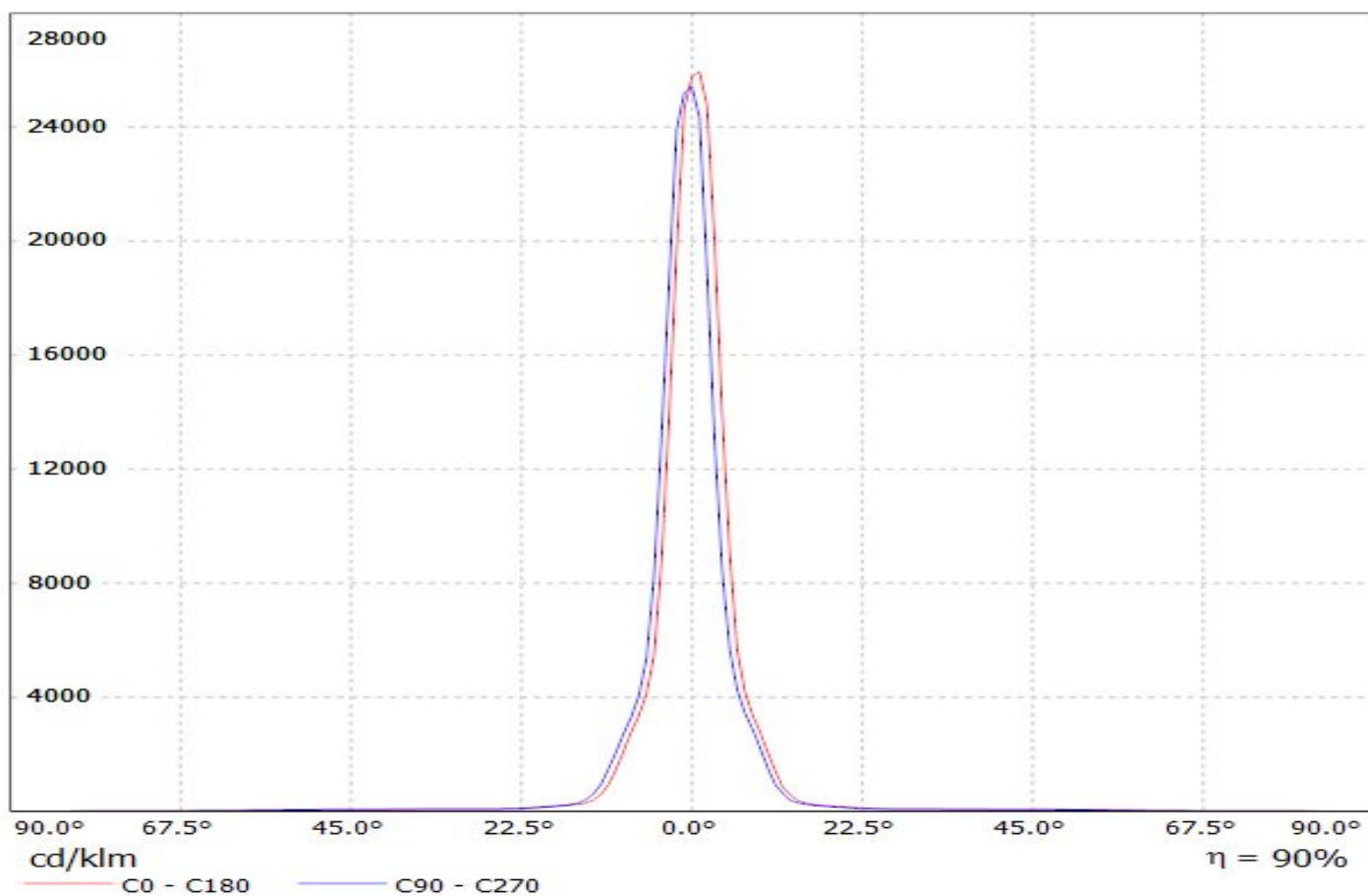

Luminaire: LEDiL Oy FCN13595_CRYSTAL-MINE_(Nichia_NV4x144A)
Lamps: 1 x Nichia_NV4x144A_478.709lm@250mA_P=2.8097W_I=0.250A

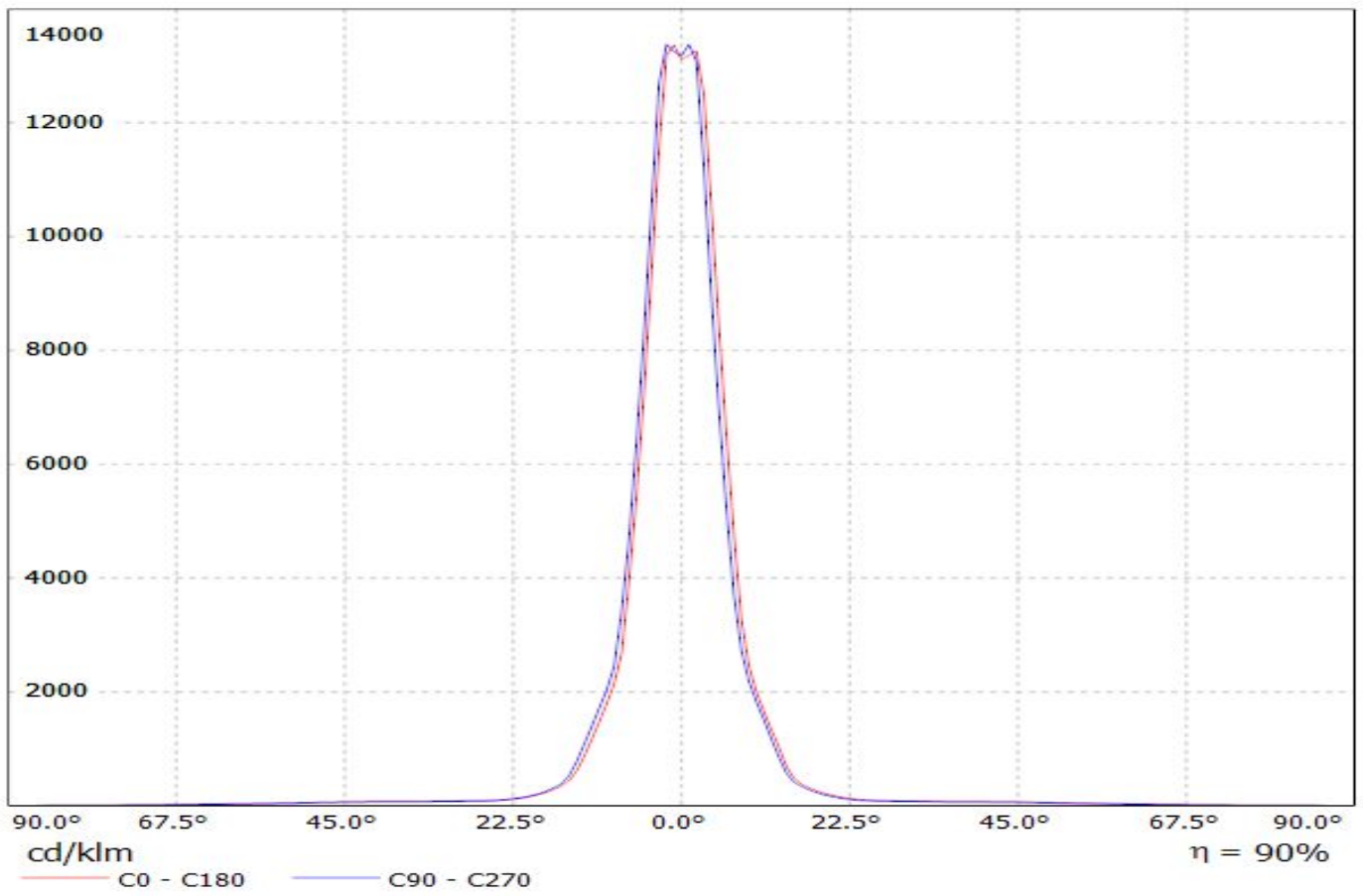

Luminaire: LEDiL Oy FCN13595_CRYSTAL-MINE_(NVSL219CE)
Lamps: 1 x Nichia_NVSL219CE_101.052lm@250mA_P=0.713154W_I=0.25A

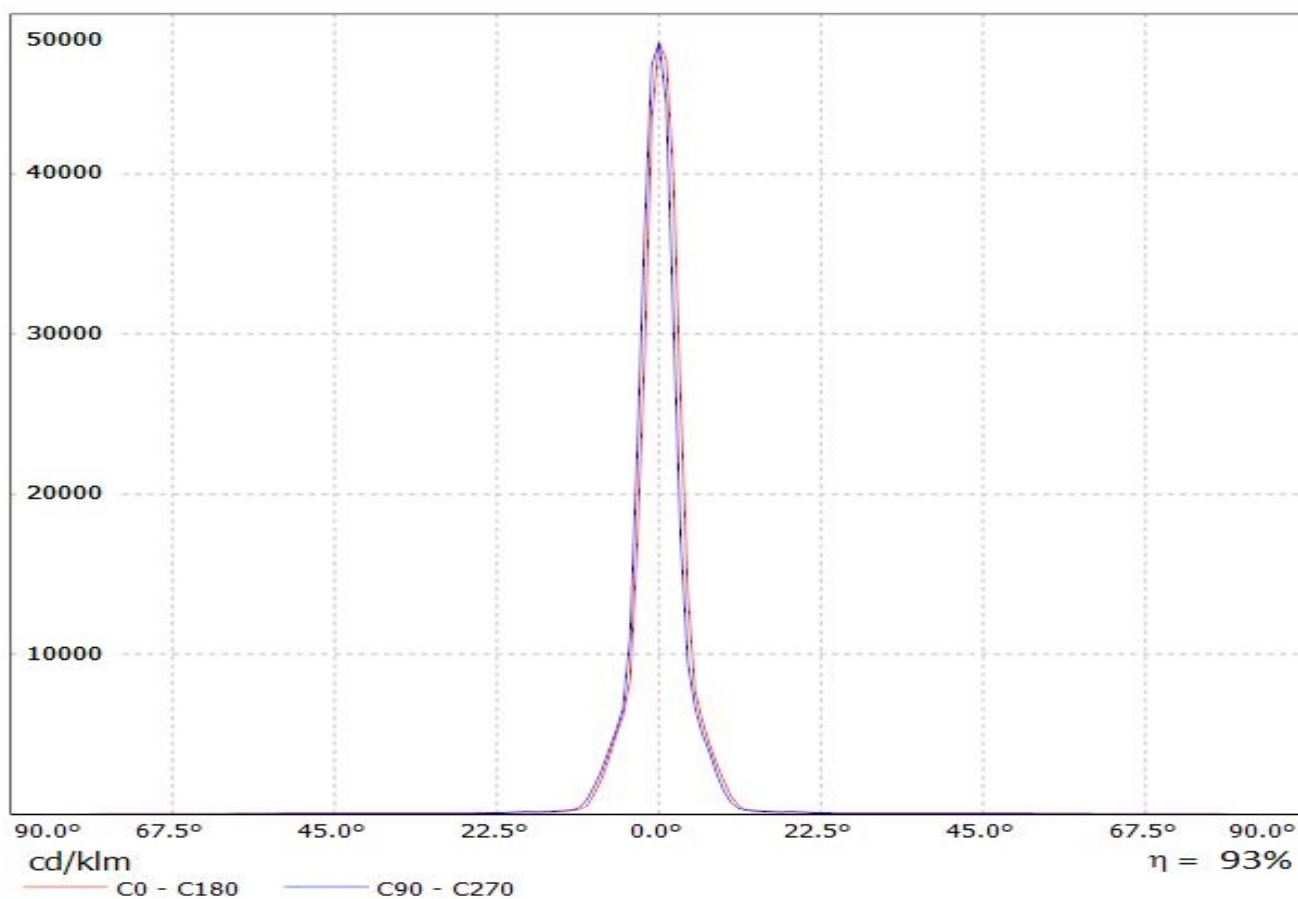

Ledil CN13595_CRYSTAL-MINE_(XP-L) / LDC (Polar)

Luminaire: Ledil CN13595_CRYSTAL-MINE_(XP-L)
Lamps: 1 x CREE_XP-L_(XPLAWT-0-7A3-U50-0H-0001)
_107.852lm@250mA_CCT=3185K_P=0.7W_I=0.25A

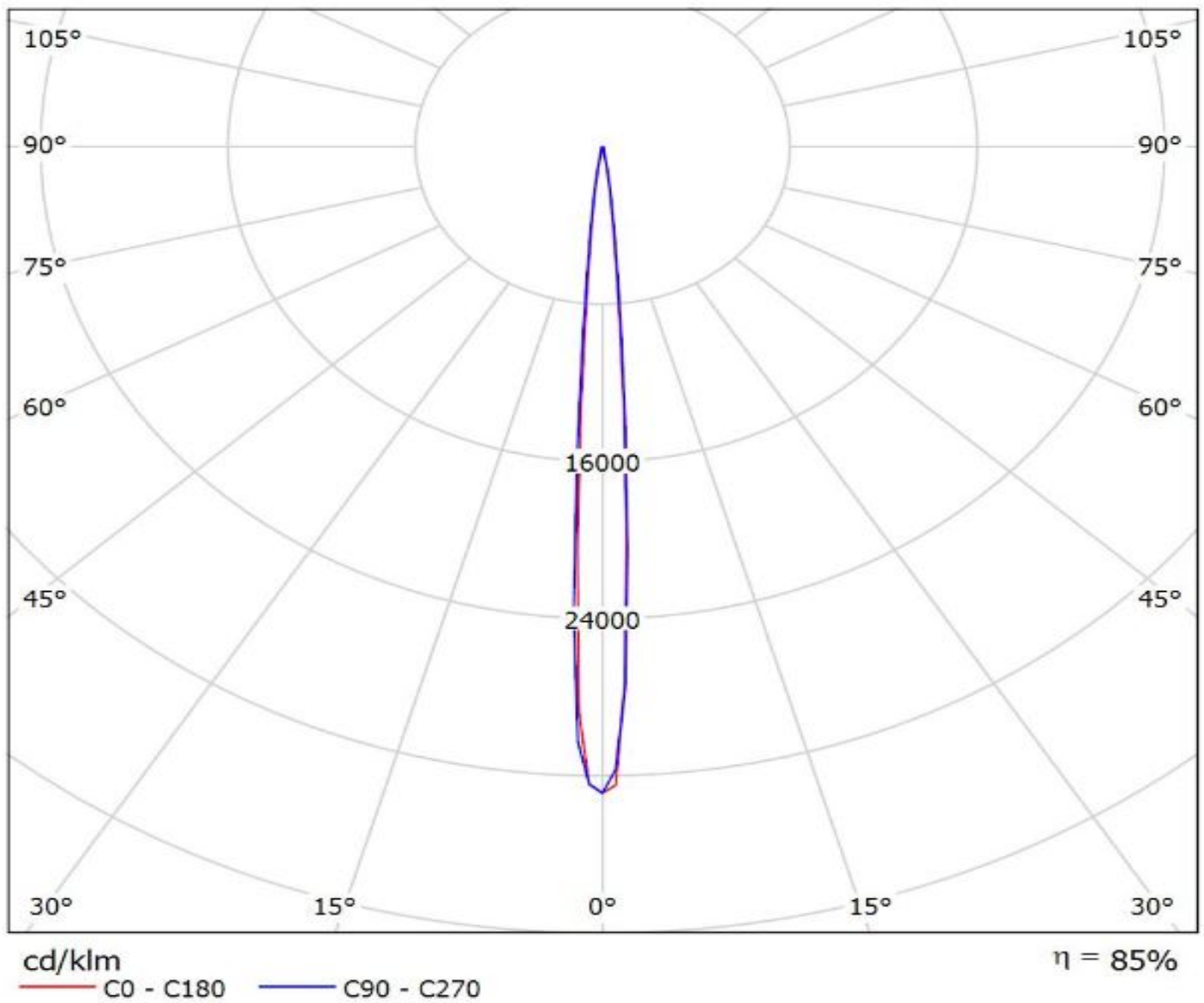

Ledil CN13595_CRYSTAL-MINE_(XP-L_HI) / LDC (Polar)

Luminaire: Ledil CN13595_CRYSTAL-MINE_(XP-L_HI)

Lamps: 1 x Cree_XP-L_HI_21.6891lm@250mA_P=0.13W_I=0.05A

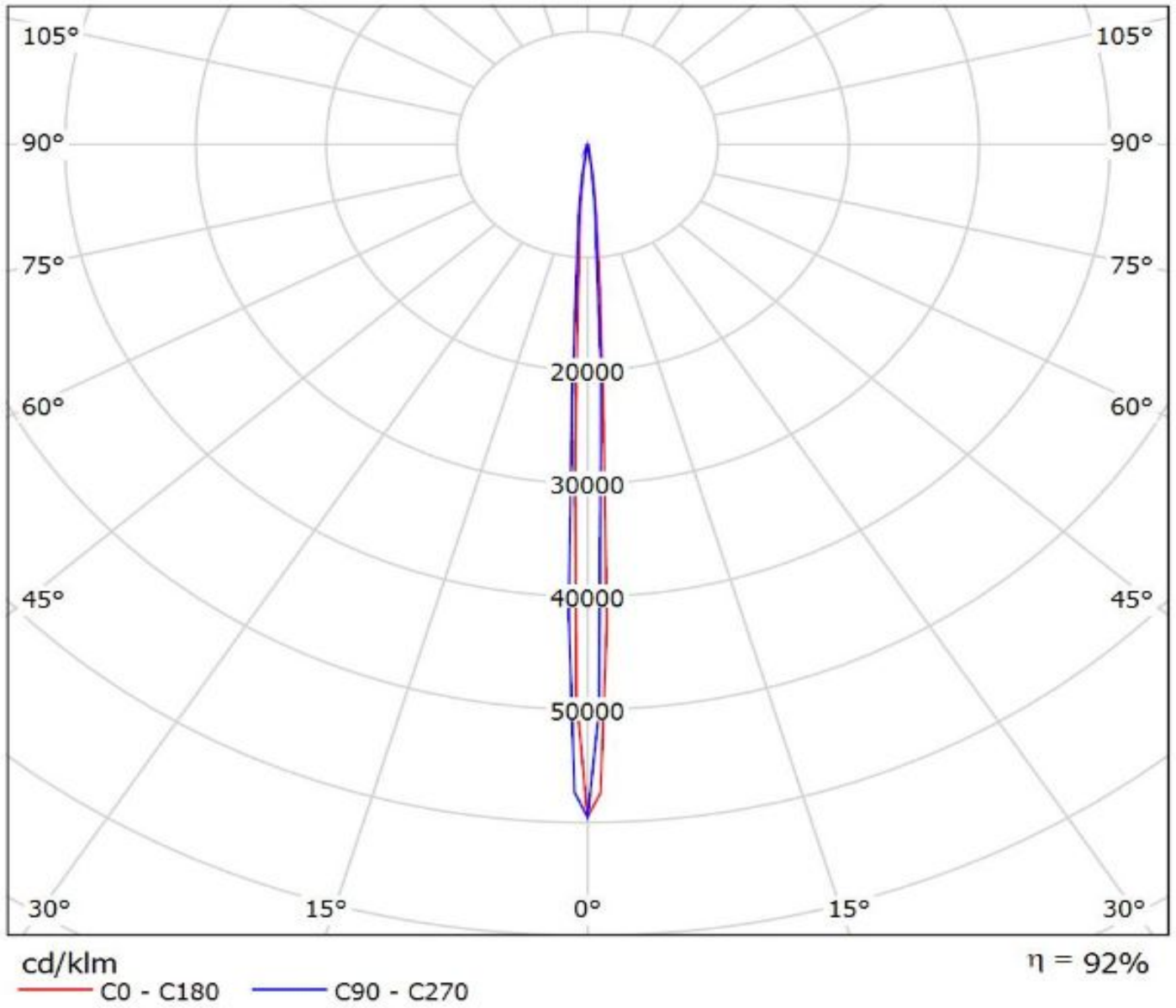

Luminaire: Ledil Oy FCN13595_CRYSTAL-MINE_(XHP35_HI)_SIMULATED

Lamps: 1 x Cree XHP35 HI

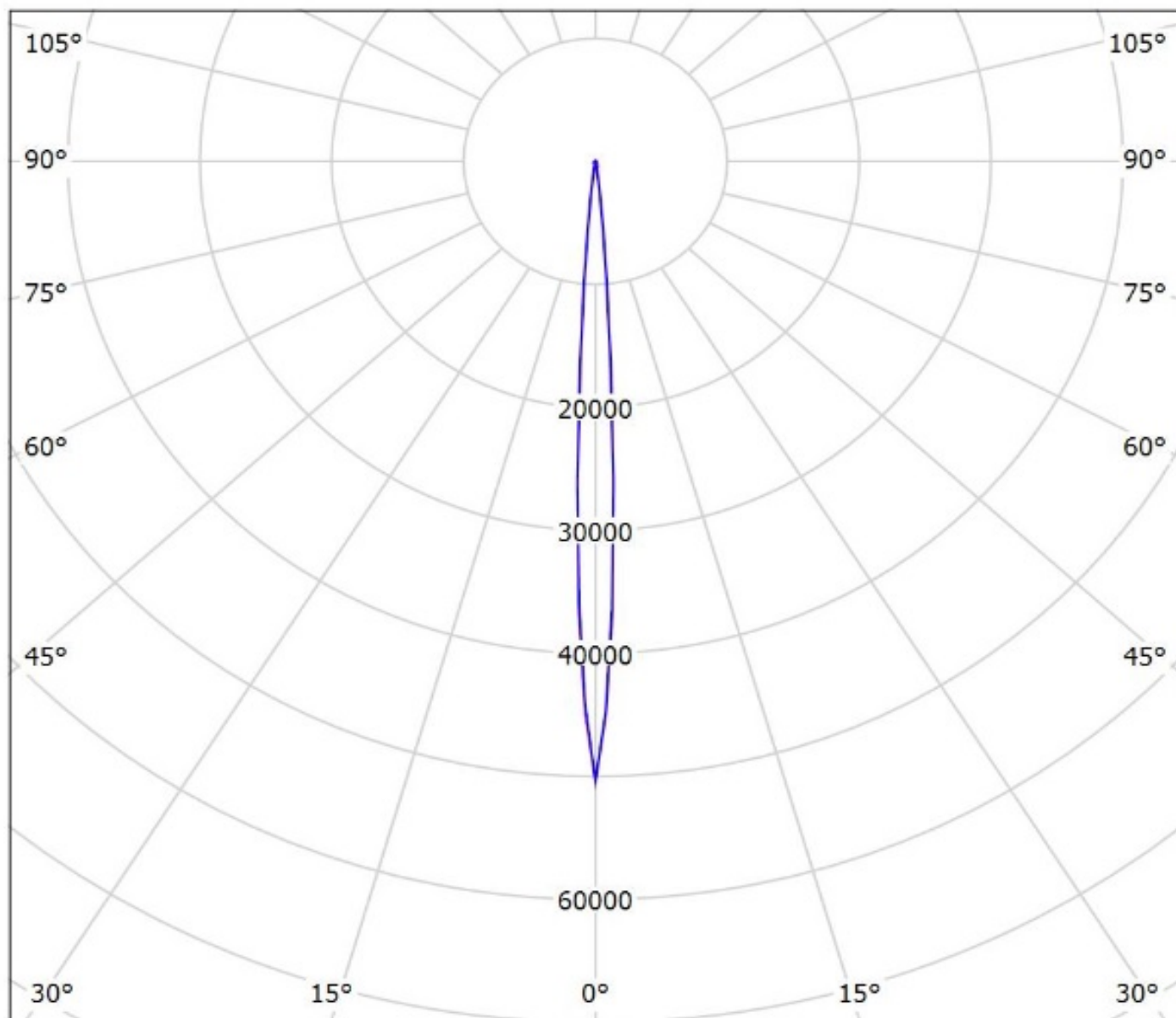

cd/klm

— C0 - C180

— C90 - C270

$\eta = 97\%$

Luminaire: Ledil Oy FCN13595_CRYSTAL-MINE_(XHP35_HD)_SIMULATED
Lamps: 1 x Cree XHP35 HD

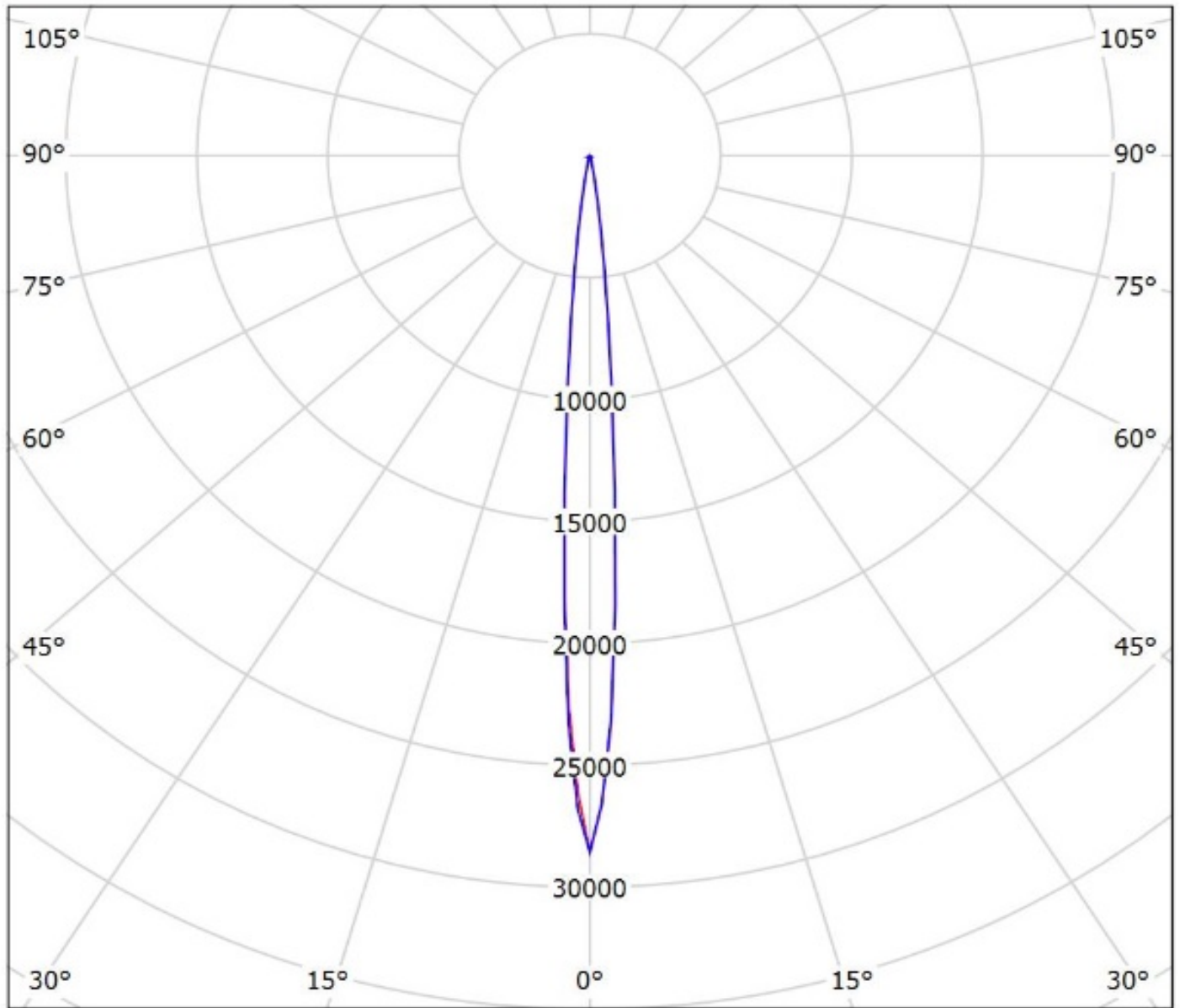

cd/klm

— C0 - C180 — C90 - C270

$\eta = 97\%$

Luminaire: LEDiL Oy CN13595_CRYSTAL-MINE_(Luxeon_TX)

Lamps: 1 x Philips_Lumileds_Luxeon_TX_(L1T2-3585)_79.5244lm@250mA_CCT=3554K_P=0.740729W_I=0.2499A

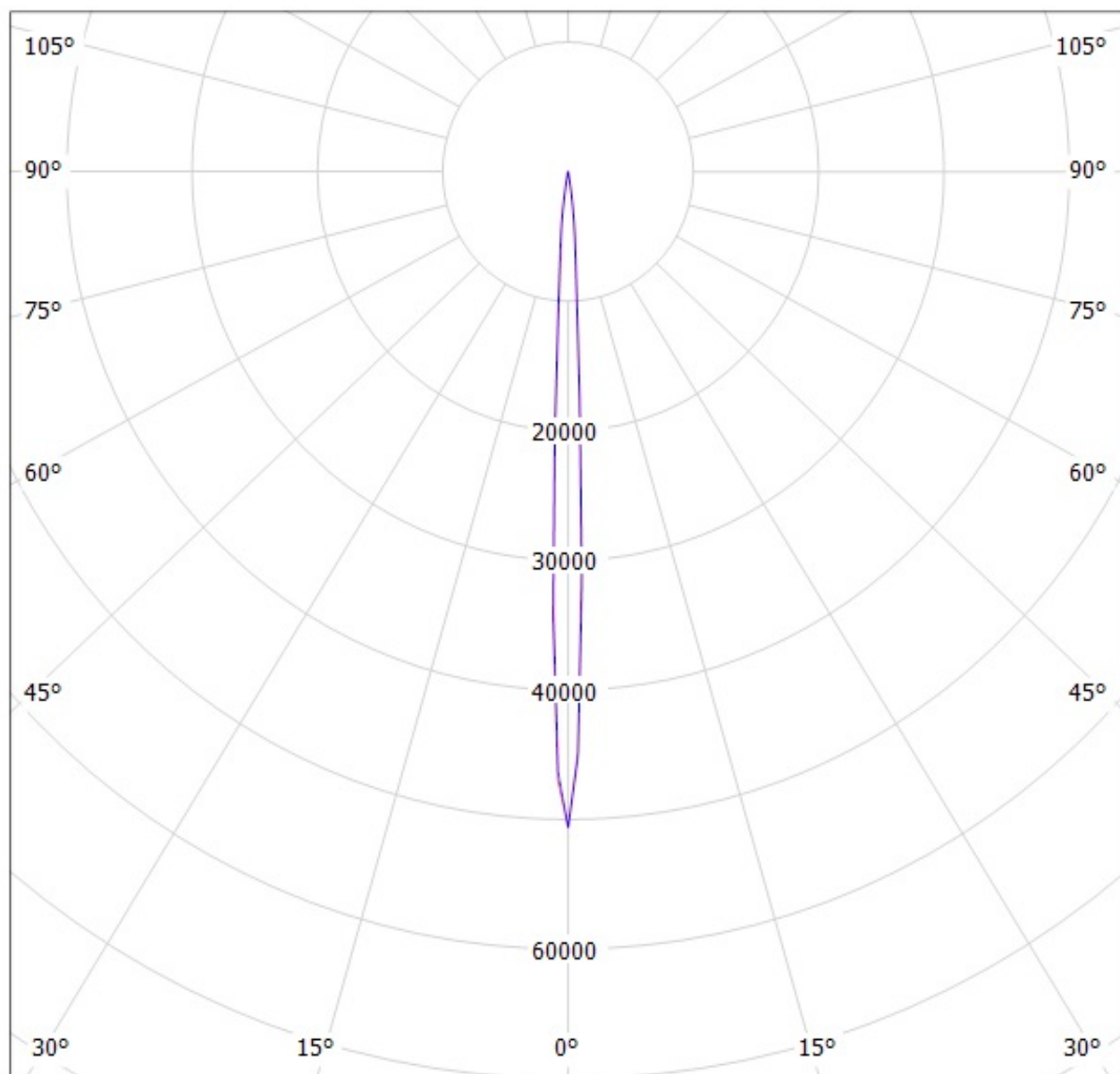

cd/klm

— C0 - C180 — C90 - C270

$\eta = 95\%$

Luminaire: Ledil Oy FCN13595_CRYSTAL-MINE_(NCSxx19B)_SIMULATED
Lamps: 1 x Nichia NCSxx19B (NCSW219B)

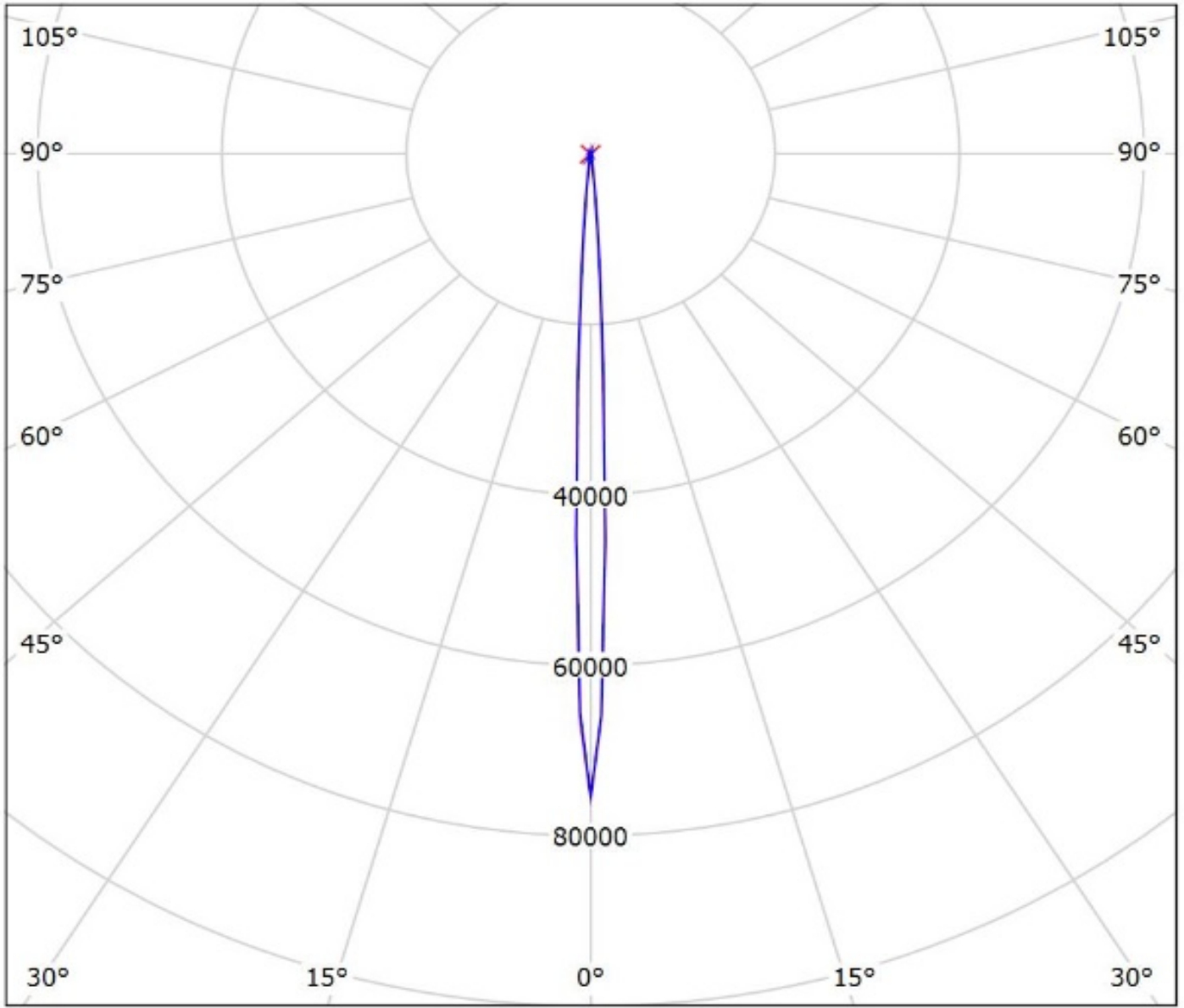

cd/klm
— C0 - C180 — C90 - C270

$\eta = 98\%$

Luminaire: LEDiL Oy FCN13595_CRYSTAL-MINE_(NWSL229AE)

Lamps: 1 x Nichia_NWSL229AE_120.514lm@250mA_P=0.7132W_I=0.250A

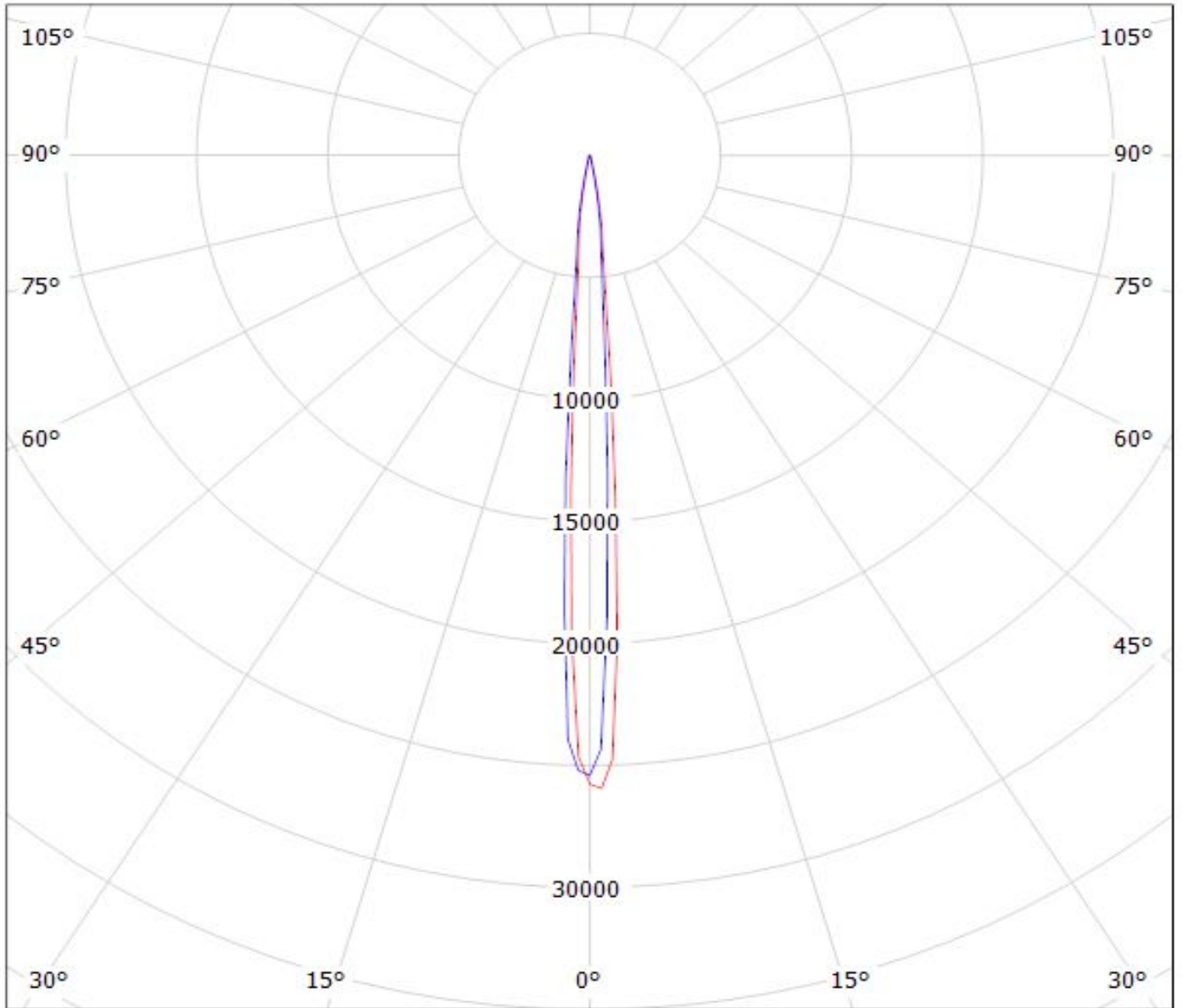

cd/klm

— C0 - C180

— C90 - C270

$\eta = 90\%$

Luminaire: LEDiL Oy FCN13595_CRYSTAL-MINE_(Nichia_NV4x144A)
Lamps: 1 x Nichia_NV4x144A_478.709lm@250mA_P=2.8097W_I=0.250A

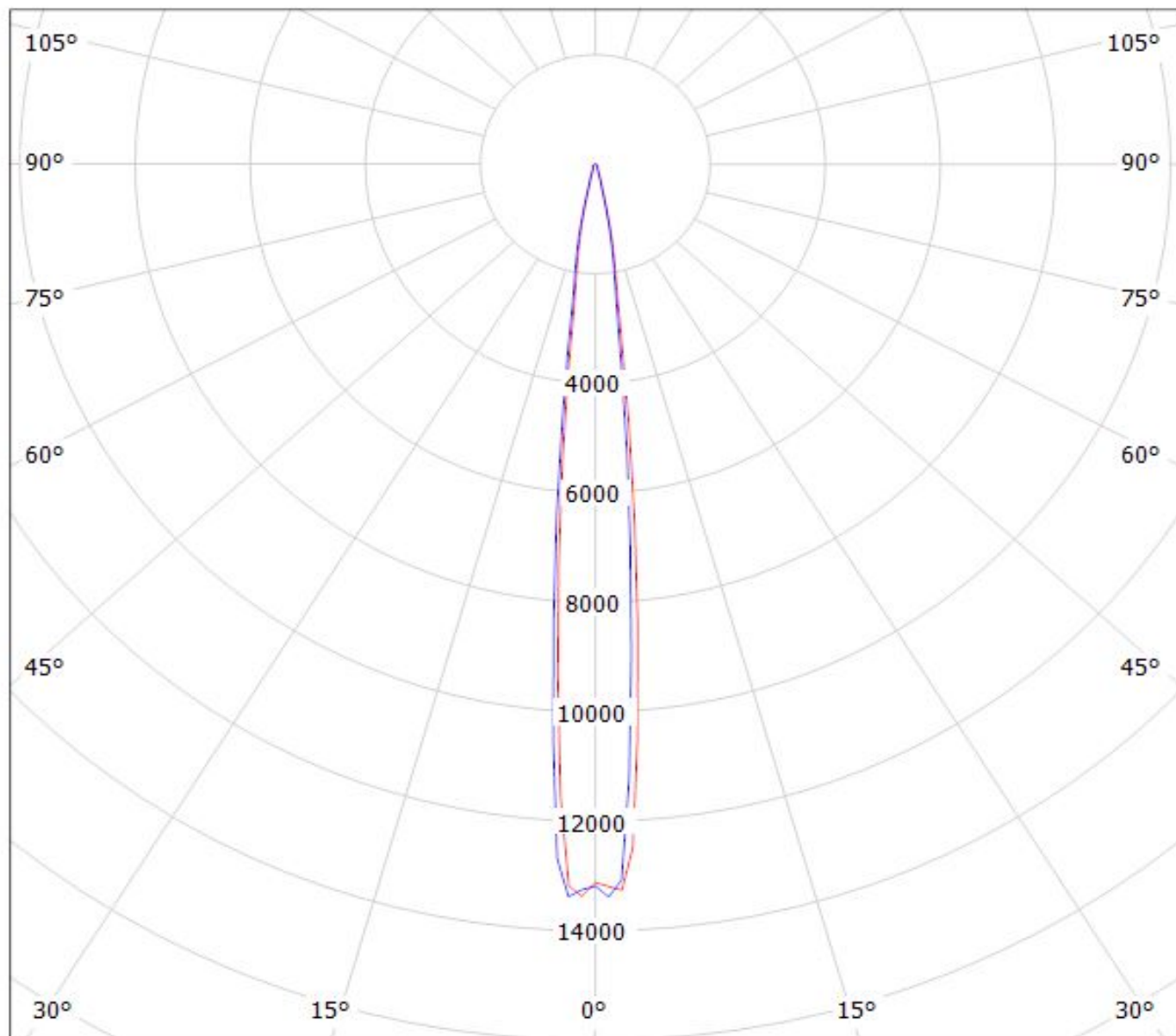

cd/klm

— C0 - C180 — C90 - C270

$\eta = 90\%$

Luminaire: LEDiL Oy FCN13595_CRYSTAL-MINE_(NVSL219CE)
Lamps: 1 x Nichia_NVSL219CE_101.052lm@250mA_P=0.713154W_I=0.25A

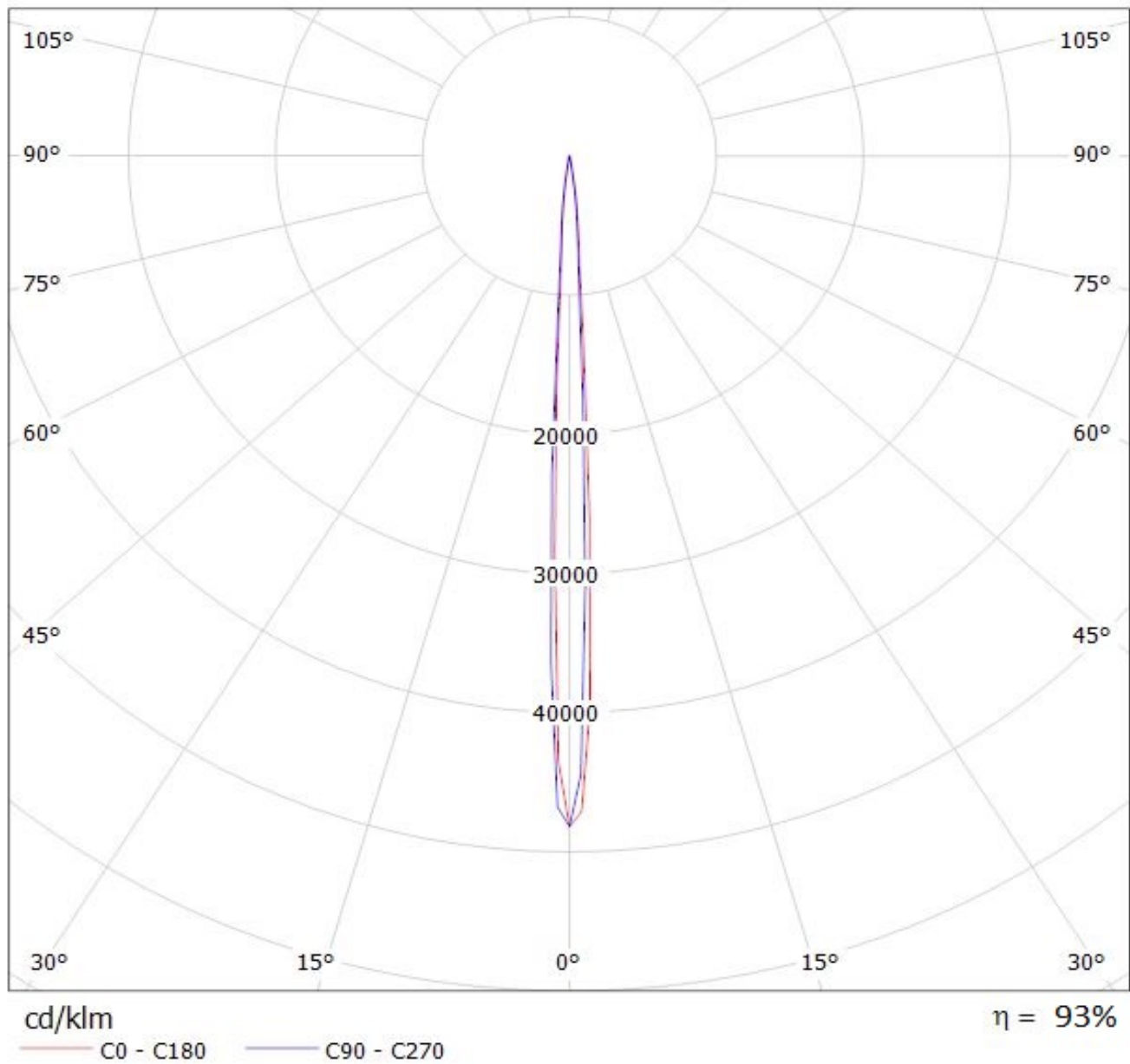

NOTE: The typical divergence will be changed by different color, chip size and chip position tolerance. The typical total divergence is the full angle measured where the luminous intensity is half of the peak value.