

MODEL:

# PDU3XVSR6G30B

## 3-Phase Switched Rackmount PDU



415V  
3-Phase Input



30A Red IEC-309 (3P+N+E)  
Plug



240V Single-Phase Output



30 Outlets  
C19



C13



18kW Load Capacity



Multimode Load Meter

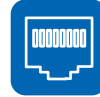

Network Interface



0U Rackmount



Toolless Mounting Buttons

- A** Multimode Load Meter
- B** C13 and C19 Outlets with Multi-Function LEDs
- C** 20A Single Pole Hydraulic Magnetic Circuit Breakers
- D** C13 and C19 Plug Inserts
- E** Removable Mounting Brackets
- F** Toolless Mounting Buttons with Removable 90° Rotation Brackets
- G** 6 ft. Input Power Cord
- H** 30A Red IEC-309 (3P+N+E) Input Plug (IP44)
- I** Durable Metal Case
- J** Network Interface
- K** RJ45 Ethernet Jack
- L** Manual Configuration Port
- M** Environmental Monitoring Port
- N** Network Interface Reset Button

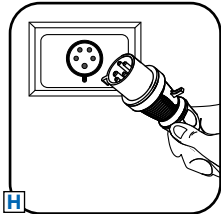

AC Input Connection: Insert 30A Red IEC-309 (3P+N+E) plug into compatible utility, generator or UPS outlet.

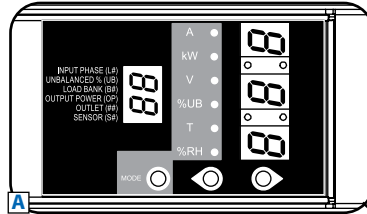

Multimode Load Meter: Display the load for any phase, bank or outlet, display temperature or humidity\*, display the IP address or rotate the display 180°.

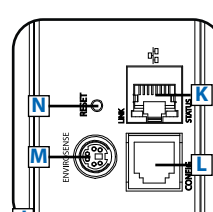
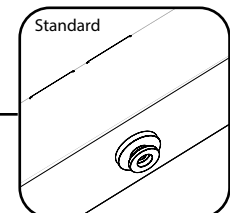
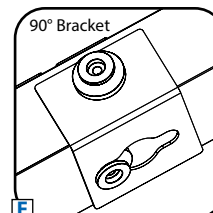
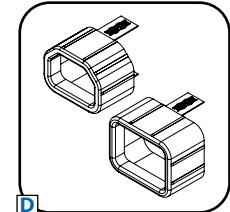
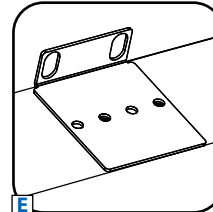
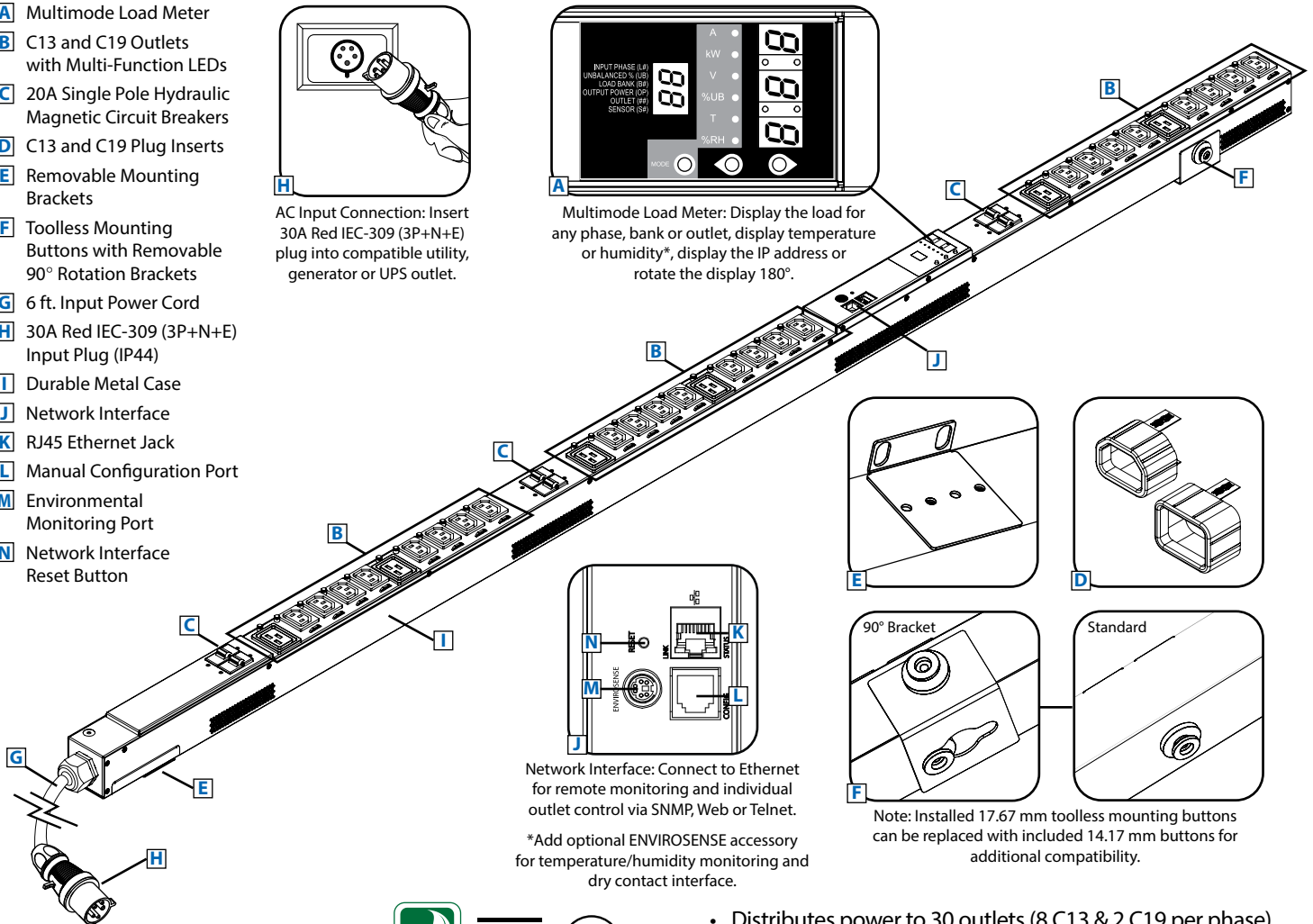

Network Interface: Connect to Ethernet for remote monitoring and individual outlet control via SNMP, Web or Telnet.  
\*Add optional ENVIROSENSE accessory for temperature/humidity monitoring and dry contact interface.

Note: Installed 17.67 mm toolless mounting buttons can be replaced with included 14.17 mm buttons for additional compatibility.

### Specifications

Model	PDU3XVSR6G30B
Voltage	415V (3-Phase Input/Single-Phase Output)
Frequency	50 / 60 Hz
Load Capacity	18kW
Input Plug	30A Red IEC-309 (3P+N+E)
Input Cord Length	6 ft.
Outlets	30 (24 C13 / 6 C19)
Primary Mounting Option	0U (Vertical) Rackmount
Unit Weight & Dimensions	17.5 lbs / 70 x 2.17 x 2.52 (HxWxD in inches) 7.9 kg / 177.8 x 5.5 x 6.4 (HxWxD in cm)
Standards	See next page for detailed unit measurements. Tested to UL 60950-1 (US & Canada), NOM (Mexico), FCC Class A, IP44 Protection Rating (Plug)

Tripp Lite has a policy of continuous improvement. Specifications are subject to change without notice.



- Distributes power to 30 outlets (8 C13 & 2 C19 per phase)
- Remote monitoring and control via SNMP, Web or Telnet
- Displays load for *each bank, phase, and outlet* in real time
- Perfect for rackmount server, network and telecom applications

**SEE NEXT PAGE FOR DETAILED UNIT MEASUREMENTS**



1111 W. 35th Street  
Chicago, IL 60609 USA  
773.869.1234  
www.tripplite.com

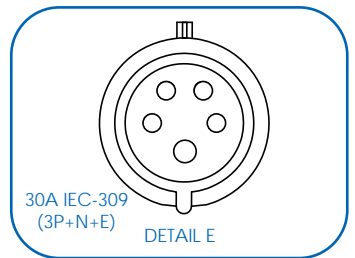
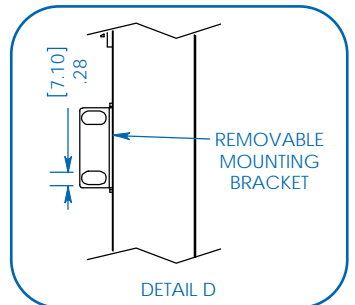
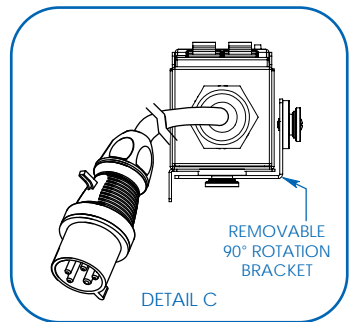
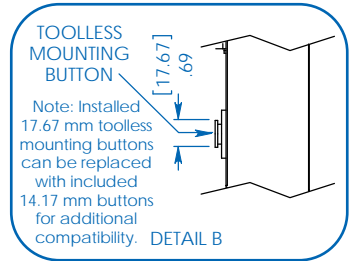
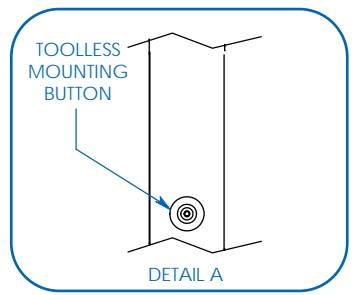
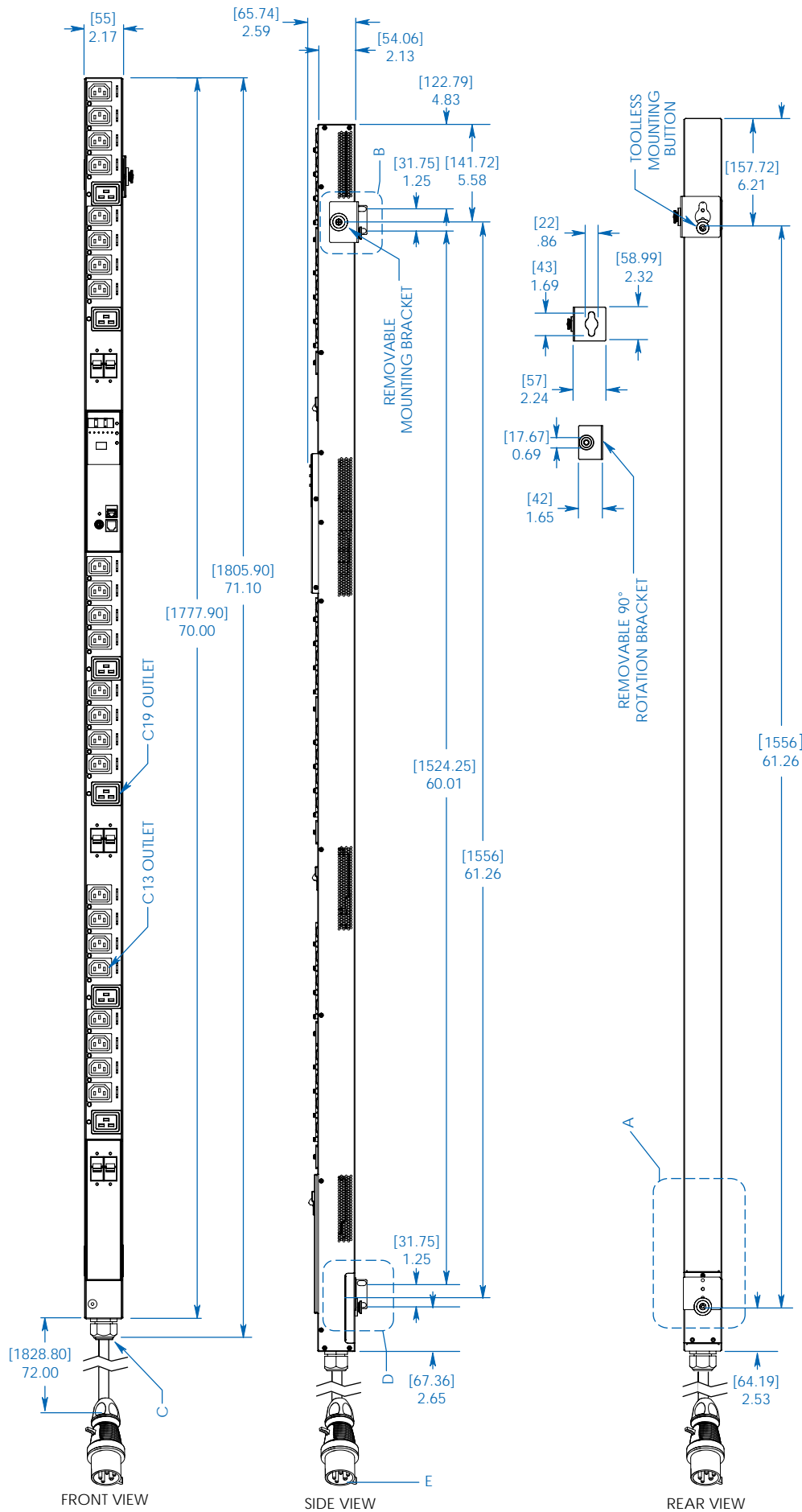

Dimensions: [mm] INCHES

Tripp Lite has a policy of continuous improvement. Specifications are subject to change without notice.

MODEL:  
**PDU3XVSR6G30B**



1111 W. 35th Street  
Chicago, IL 60609 USA  
773.869.1234

www.tripplite.com