

COUNT	DESCRIPTION OF REVISIONS	BY	CHKD	DATE	COUNT	DESCRIPTION OF REVISIONS	BY	CHKD	DATE
△					△				
△					△				
△					△				

PART No.	CODE No.	NUMBER OF CONTACTS	A	B	C
DF13-2P-1.25DSA(20)	CL536-0101-9-20	2	1.25	3.15	4.15
DF13-3P-1.25DSA(20)	CL536-0102-1-20	3	2.5	4.4	5.4
DF13-4P-1.25DSA(20)	CL536-0103-4-20	4	3.75	5.65	6.65
DF13-5P-1.25DSA(20)	CL536-0104-7-20	5	5	6.9	7.9
DF13-6P-1.25DSA(20)	CL536-0105-0-20	6	6.25	8.15	9.15
DF13-7P-1.25DSA(20)	CL536-0106-2-20	7	7.5	9.4	10.4
DF13-8P-1.25DSA(20)	CL536-0107-5-20	8	8.75	10.65	11.65
DF13-9P-1.25DSA(20)	CL536-0108-8-20	9	10	11.9	12.9
DF13-10P-1.25DSA(20)	CL536-0109-0-20	10	11.25	13.15	14.15
DF13-11P-1.25DSA(20)	CL536-0110-0-20	11	12.5	14.4	15.4
DF13-12P-1.25DSA(20)	CL536-0111-2-20	12	13.75	15.65	16.65
DF13-13P-1.25DSA(20)	CL536-0112-5-20	13	15	16.9	17.9
DF13-14P-1.25DSA(20)	CL536-0113-8-20	14	16.25	18.15	19.15
DF13-15P-1.25DSA(20)	CL536-0114-0-20	15	17.5	19.4	20.4

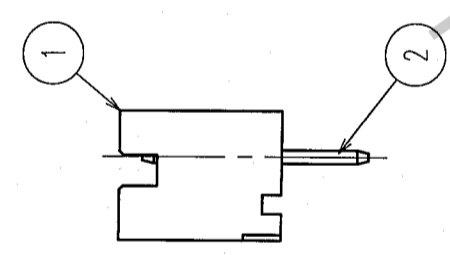

2 APPLICATION FIGURE

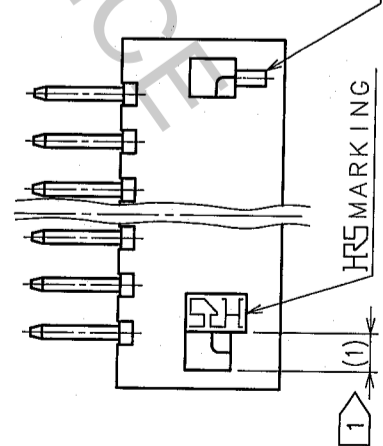
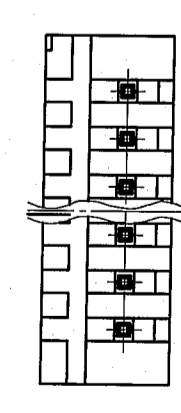
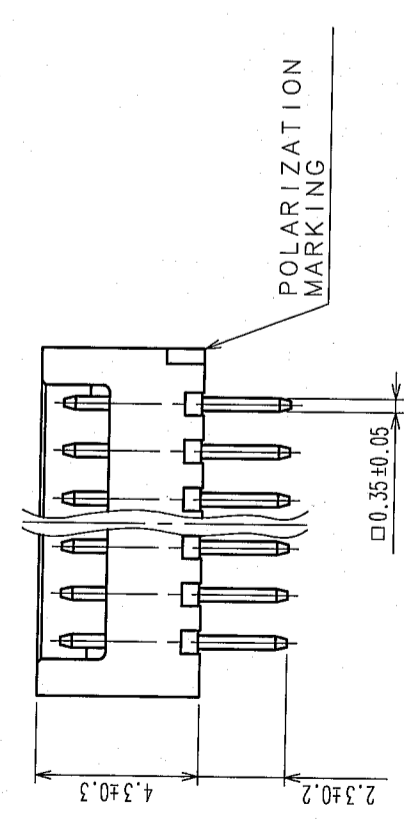
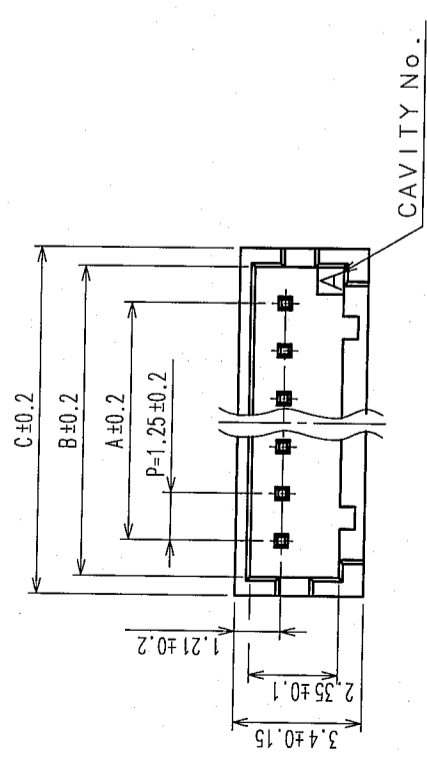
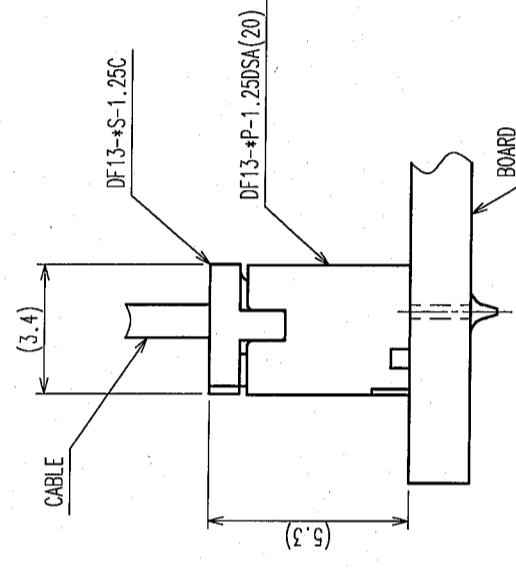

- 1 WHEN THIS CONNECTOR HAS TWO OR THREE CONTACTS, THE LOCK OF CONNECTOR SHALL BE SET AT THE CENTER OF HOUSING. IN CASE THAT THE NUMBER OF CONTACTS IS MORE THAN FOUR, THE TWO LOCKS SHALL BE SET IN ACCORDANCE WITH THE DRAWINGS.
- 2 WHEN THIS CONNECTOR MATES WITH DF13-*S-1.25C, THE MATING LENGTH IS 5.3mm.
- 3 RECOMMENDED DIP POST DIA. : φ 0.6±0.03

2	BRASS	SURFACE: TIN PLATED 1μm min.	4	STYRENIC-BASED ELASTOMERS	STOPPER, GREEN
1	POLYAMIDE	BEIGE(NATURAL), UL94V-0	3	PS	ELECTROSTATIC PROTECTION, CLEAR
NO.	MATERIAL	FINISH, REMARKS	NO.	MATERIAL	FINISH, REMARKS
CODE NO. (OLD)		DRAWN		DESIGNED	CHECKED
		T. Kumogawa		T. Kumogawa	H. Tanahara
		05.11.16		05.11.16	05.11.16
				J. Ono	
DRAWING NO.		PART NO.			
EDC3-083673-05		DF13-*P-1.25DSA(20)			
SCALE		CODE NO.			
5 : 1		CL536-			
UNITS					
mm					

COUNT	DESCRIPTION OF REVISIONS	BY	CHKD	DATE	COUNT	DESCRIPTION OF REVISIONS	BY	CHKD	DATE
△					△				
△					△				
△					△				

510-3

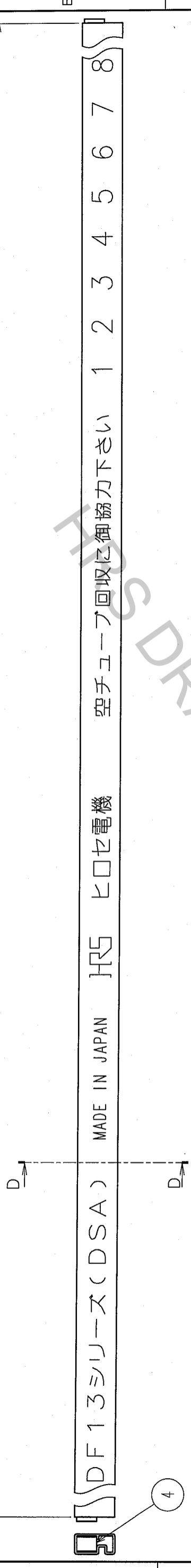

DF13シリーズ(DSA) MADE IN JAPAN HRS ヒロセ電機 空チューブ回収に御協力下さい 1 2 3 4 5 6 7 8

PART No.	CODE No.	NUMBER OF CONTACTS	QUANTITY OF CONNECTORS
DF13-2P-1.25DSA(20)	CL536-0101-9-20	2	115
DF13-3P-1.25DSA(20)	CL536-0102-1-20	3	89
DF13-4P-1.25DSA(20)	CL536-0103-4-20	4	72
DF13-5P-1.25DSA(20)	CL536-0104-7-20	5	61
DF13-6P-1.25DSA(20)	CL536-0105-0-20	6	52
DF13-7P-1.25DSA(20)	CL536-0106-2-20	7	46
DF13-8P-1.25DSA(20)	CL536-0107-5-20	8	41
DF13-9P-1.25DSA(20)	CL536-0108-8-20	9	37
DF13-10P-1.25DSA(20)	CL536-0109-0-20	10	34
DF13-11P-1.25DSA(20)	CL536-0110-0-20	11	31
DF13-12P-1.25DSA(20)	CL536-0111-2-20	12	29
DF13-13P-1.25DSA(20)	CL536-0112-5-20	13	27
DF13-14P-1.25DSA(20)	CL536-0113-8-20	14	25
DF13-15P-1.25DSA(20)	CL536-0114-0-20	15	23

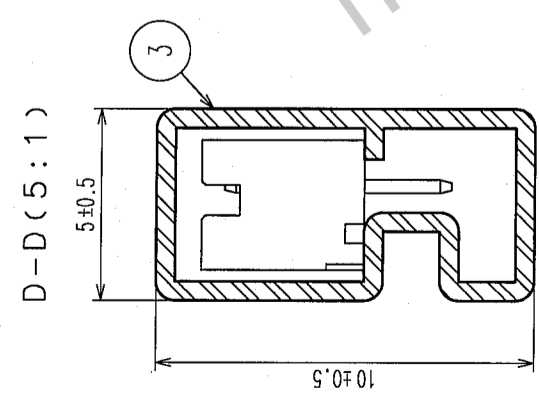

NOTE4. MINIMUM UNIT OF PURCHASE SHALL BE THE QUANTITY OF CONNECTORS IN TUBE.

TO

NO.	MATERIAL	FINISH, REMARKS	NO.	MATERIAL	FINISH, REMARKS
CODE NO. (OLD)			DRAWN	DESIGNED	CHECKED
			7. Kumagawa T. Kumagawa H. Umemura		J. Ota
			'05.11.16	'05.11.16	'05.11.16
DRAWING NO.		PART NO.		FINISH, REMARKS	
SCALE		EDC3-083673-05		DF13-*P-1.25DSA(20)	
FREE		HRS		HIROSE ELECTRIC CO., LTD	
UNITS		CL536-		2	