

## DETAILS

<b>Product Number</b>	C13237_HB-2X2-WW-BLIND
<b>Family</b>	HB
<b>Type</b>	Lens array
<b>Color</b>	clear
<b>Diameter</b>	50x50 mm
<b>Height</b>	8,5 mm
<b>Style</b>	square
<b>Optic Material</b>	PMMA
<b>Holder Material</b>	
<b>Fastening</b>	pin, glue
<b>Status</b>	production ready
<b>ROHS Compliant</b>	Yes
<b>Date Updated</b>	21/04/2016



## OPTICAL PROPERTIES

LED	Viewing	Light	Effi-	cd/lm	Connector
	Angle	Beam	ciency		
XT-E	65 deg	Very Wide	91 %	0.900	-
XP-G	69 deg	Very Wide	91 %	0.800	-
XP-G2	69 deg	Very Wide	91 %	0.700	-
H35C1 (LEMWA33)	68 deg	Very Wide	89 %	0.800	-
LUXEON Z ES	59 deg	Very Wide	90 %	1.000	-
LUXEON Q	67 deg	Very Wide	91 %	0.800	-
NVSxx19B/NVSxx19C	67 deg	Very Wide	91 %	0.800	-
Oslon Square PC	65 deg	Very Wide	91 %	0.800	-
Oslon Square Gen3	sim: 69	Very Wide	sim: 94 %	sim: 1.070	-
LH351Z	63 deg	Very Wide	89 %	0.860	-
Z5M1/Z5M2	65 deg	Very Wide	90 %	0.900	-
TL1L4	60 deg	Very Wide	84 %	0.870	-
RLE G1 49x223mm 4000lm xxx EXC OTB7	deg	Very Wide	94 %	0.850	-
RLE G1 49x121mm 2000lm xxx EXC OTB7	deg	Very Wide	94 %	0.850	-
RLE G1 49x133mm 2000lm xxx EXC OTB7	deg	Very Wide	94 %	0.850	-
RLE G1 49x245mm 4000lm xxx EXC OTB7	deg	Very Wide	94 %	0.850	-

D C B A

4

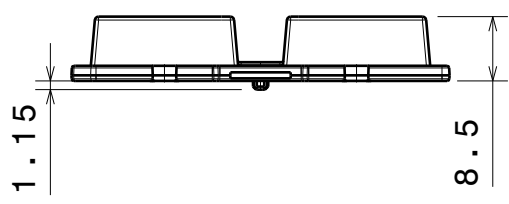

Front view

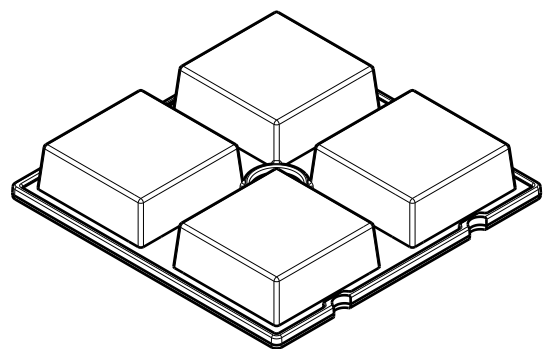

Isometric view

3

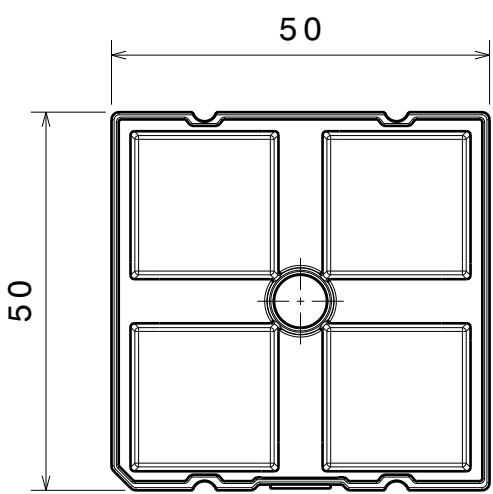

Top view

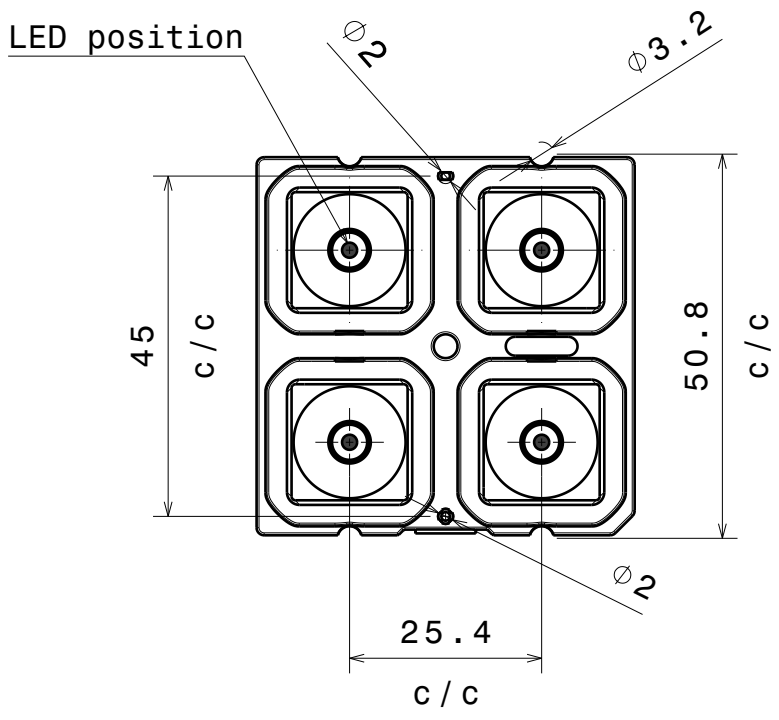

Bottom view

2

1

INDEX	PART NO	DESCRIPTION	MATERIAL	COLOUR
1	C13237	HB-2X2-WW-BLIND	PMMA	

Tolerances if not otherwise shown  
According to DIN ISO 2768-1  
Linear measures:  
up to 30mm class M, otherwise class C  
According to DIN ISO 2768-2  
Form and position: class L

**LEDiL** LediL Oy  
Salorankatu 10  
FIN 24240 SALO  
Finland

THIRD ANGLE PROJECTION:

DRAWING TITLE  
**C13237\_HB-2X2-WW-BLIND**

This drawing is the property of LEDiL Oy. It may not be reproduced, copied or communicated without a written agreement with LEDiL Oy.

SIZE	PART NUMBER
A4	C13237

SCALE	1:1	WEIGHT	10,7 g	SHEET	1/1
-------	-----	--------	--------	-------	-----

D A

Luminaire: Ledil Oy C13237&C13232\_HB-2X2-WW (Cree XT-E 390lm @ 250mA) Efficiency=91%  
Lamps: 1 x Cree XT-E 390lm @ 250mA

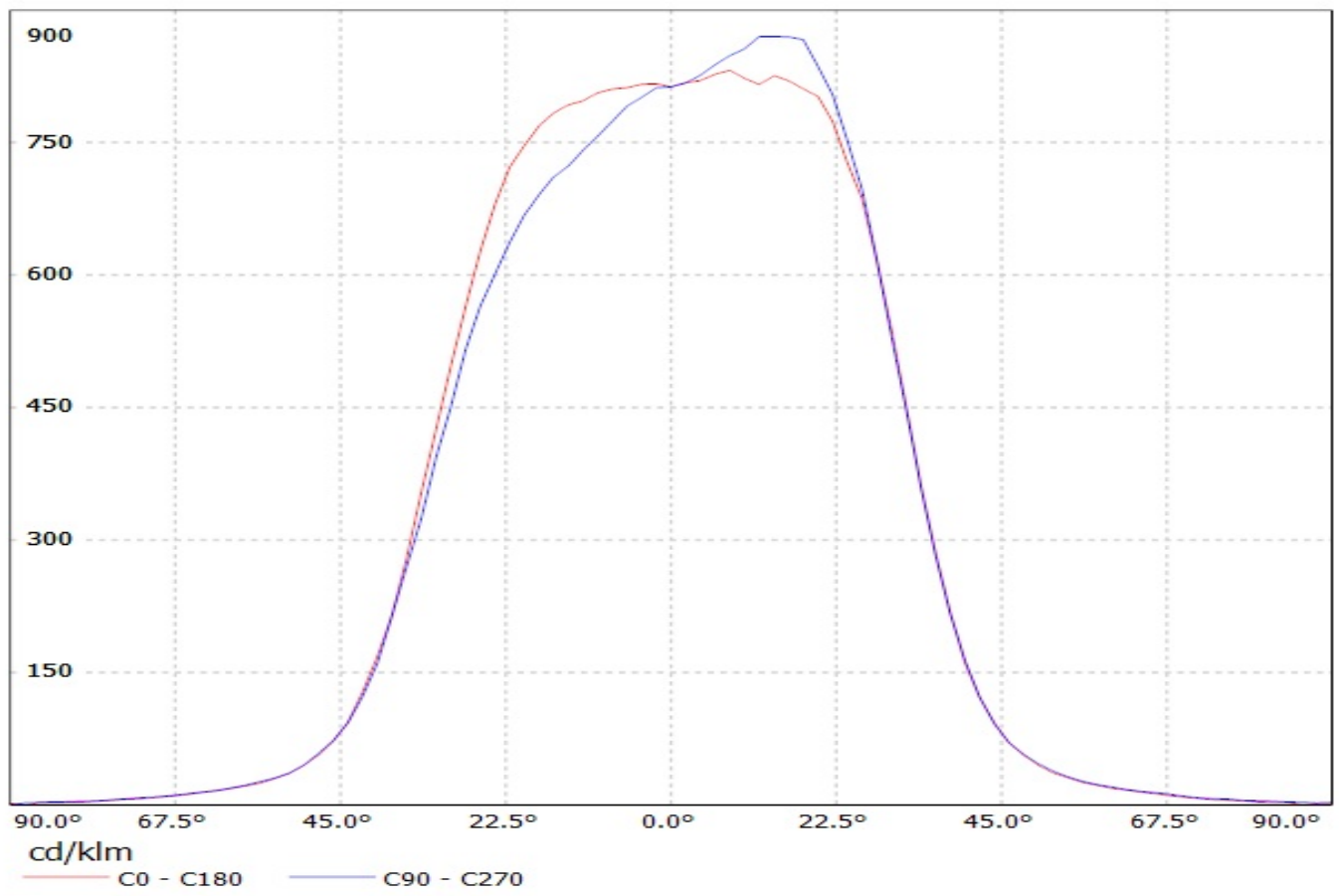

Luminaire: Ledil Oy C13237&C13232\_HB-2X2-WW (Cree XP-G 257lm @ 250mA) Efficiency=91%  
Lamps: 1 x Cree XP-G 257lm @ 250mA

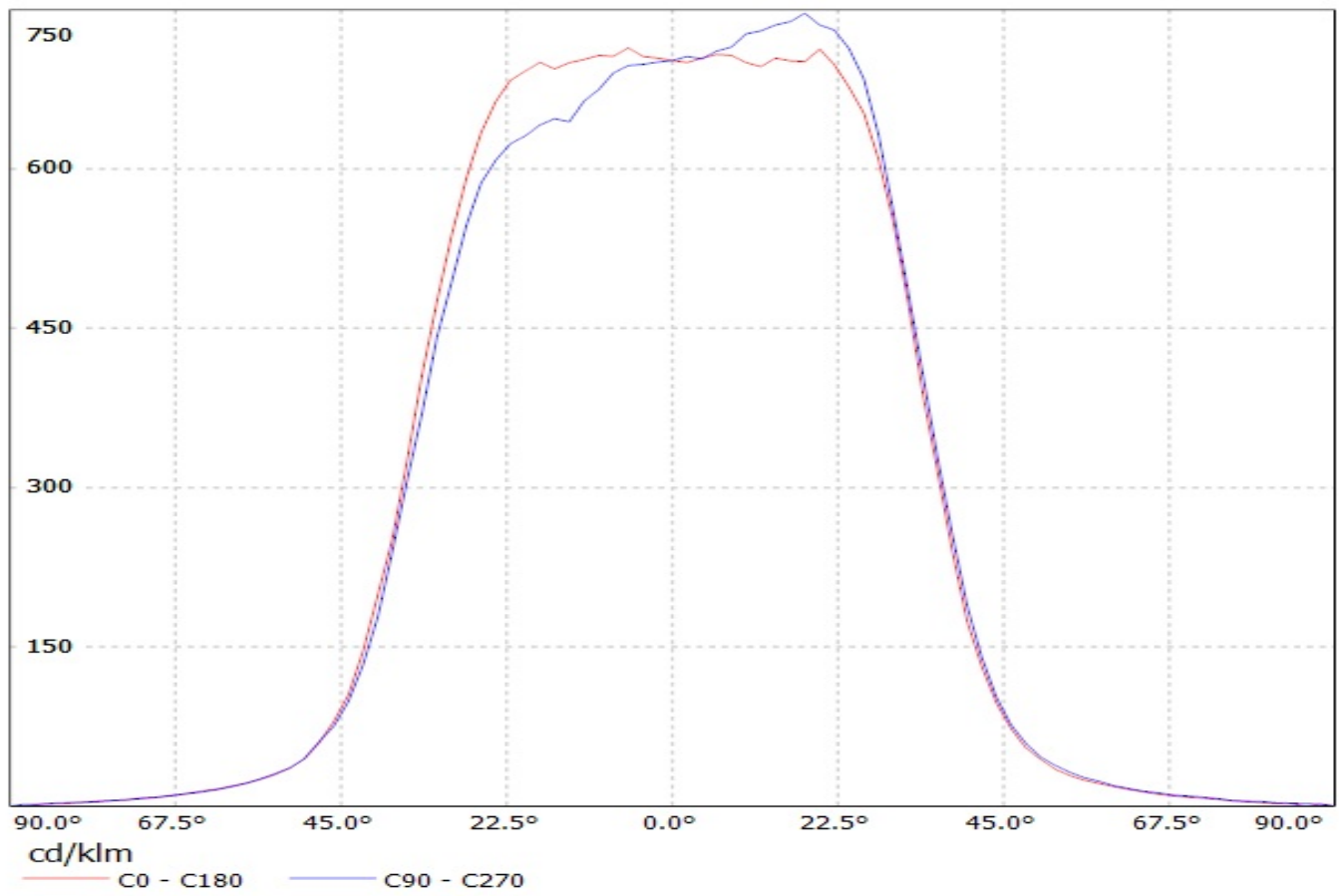

Luminaire: Ledil Oy C13237&C13232\_HB-2X2-WW (Cree XP-G2 420lm @ 250mA) Efficiency=91%  
Lamps: 1 x Cree XP-G2 420lm @ 250mA

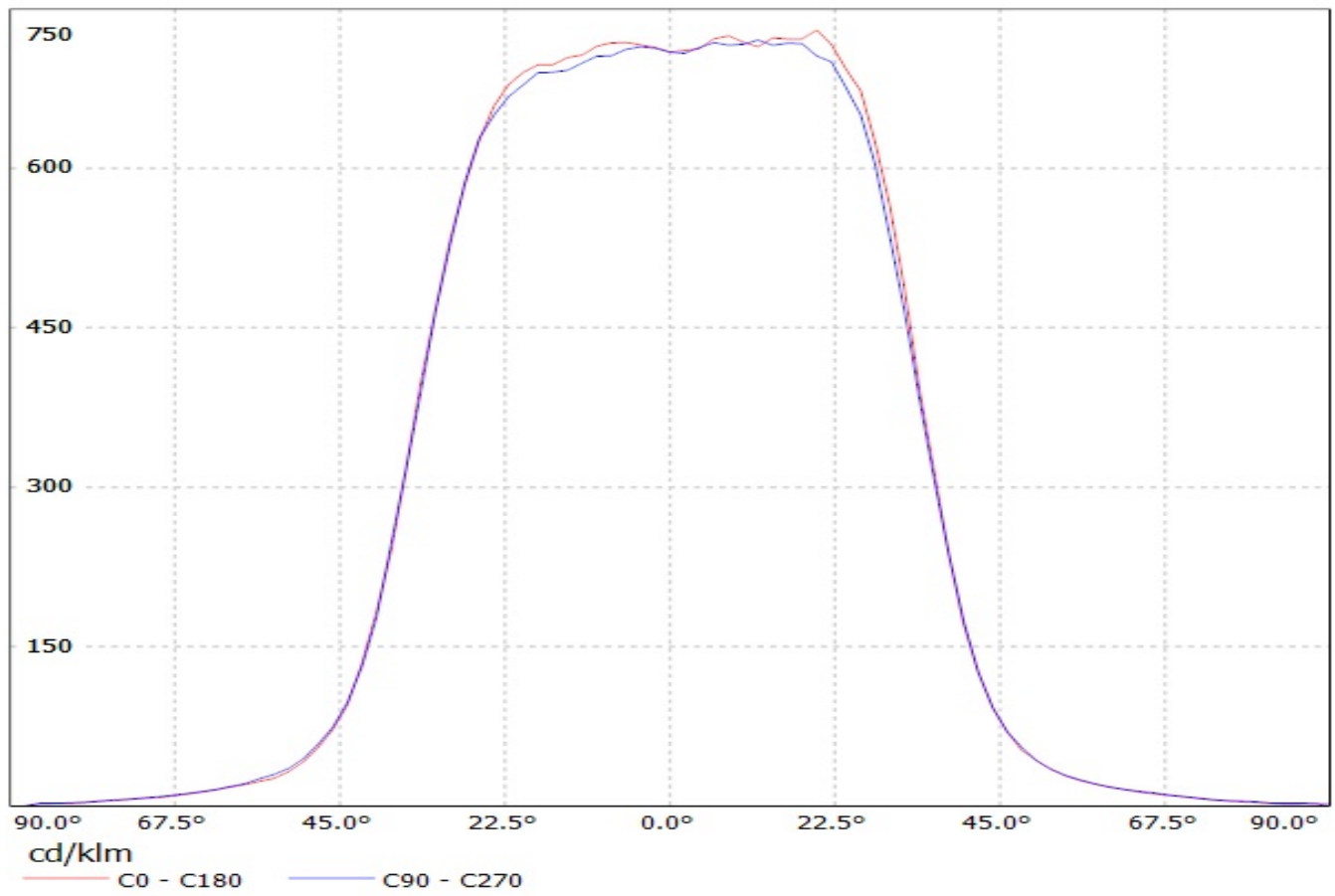

Luminaire: Ledil Oy C13237\_HB-2X2-WW-BLIND\_(3535\_Ceramic\_gen2) Efficiency=86%  
Lamps: 1 x LG 3535 Ceramic gen2 (PKG5700K) 461lm @ 250mA CCT=6600K P=2.9W I=250mA

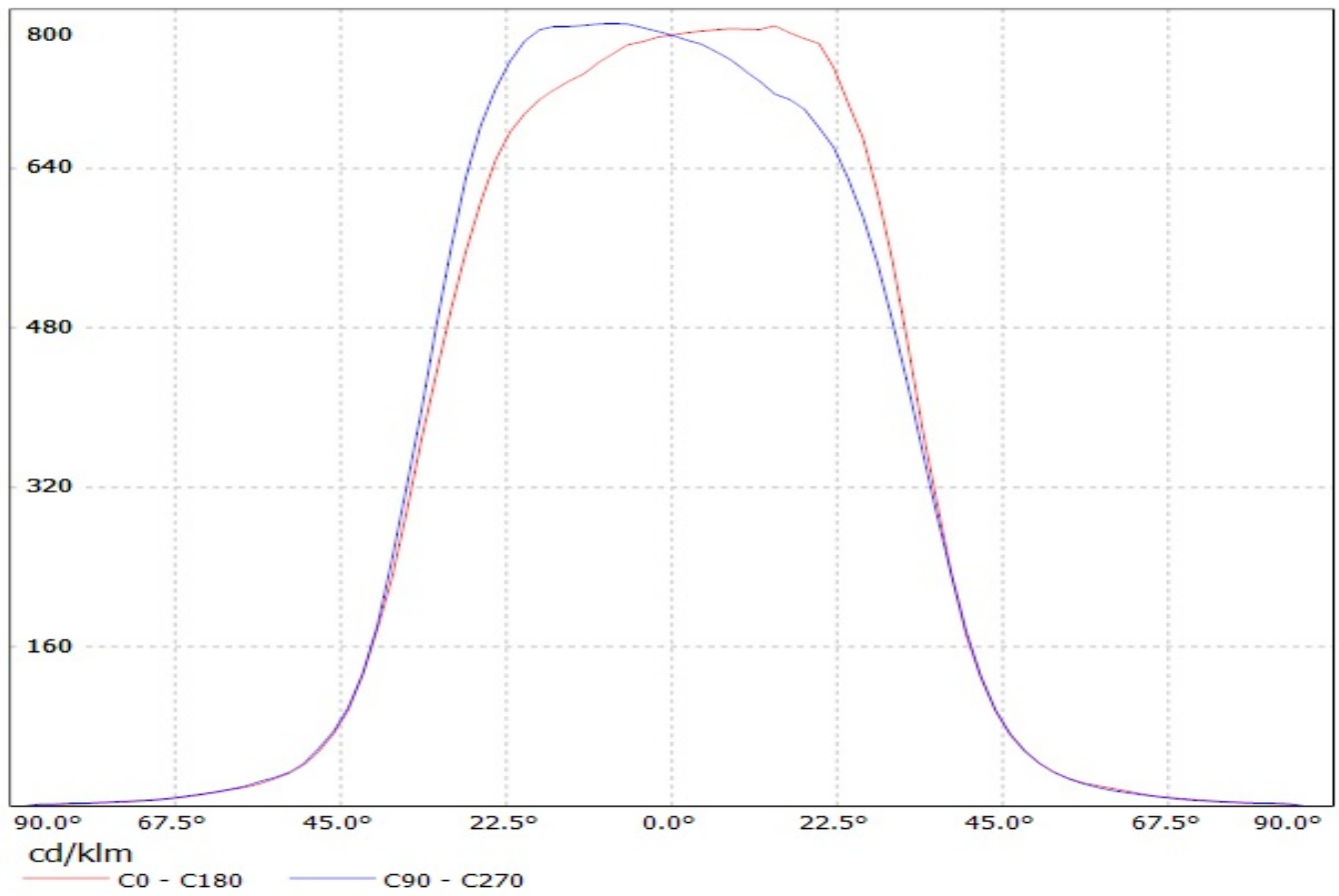

Luminaire: Ledil Oy C13237\_HB-2X2-WW-BLIND\_(Luxeon\_Z\_ES) Efficiency=90%  
Lamps: 1 x Luxeon Z ES (LX22-3090) 209lm @ 250mA CCT=3000k P=2.8W I=250mA

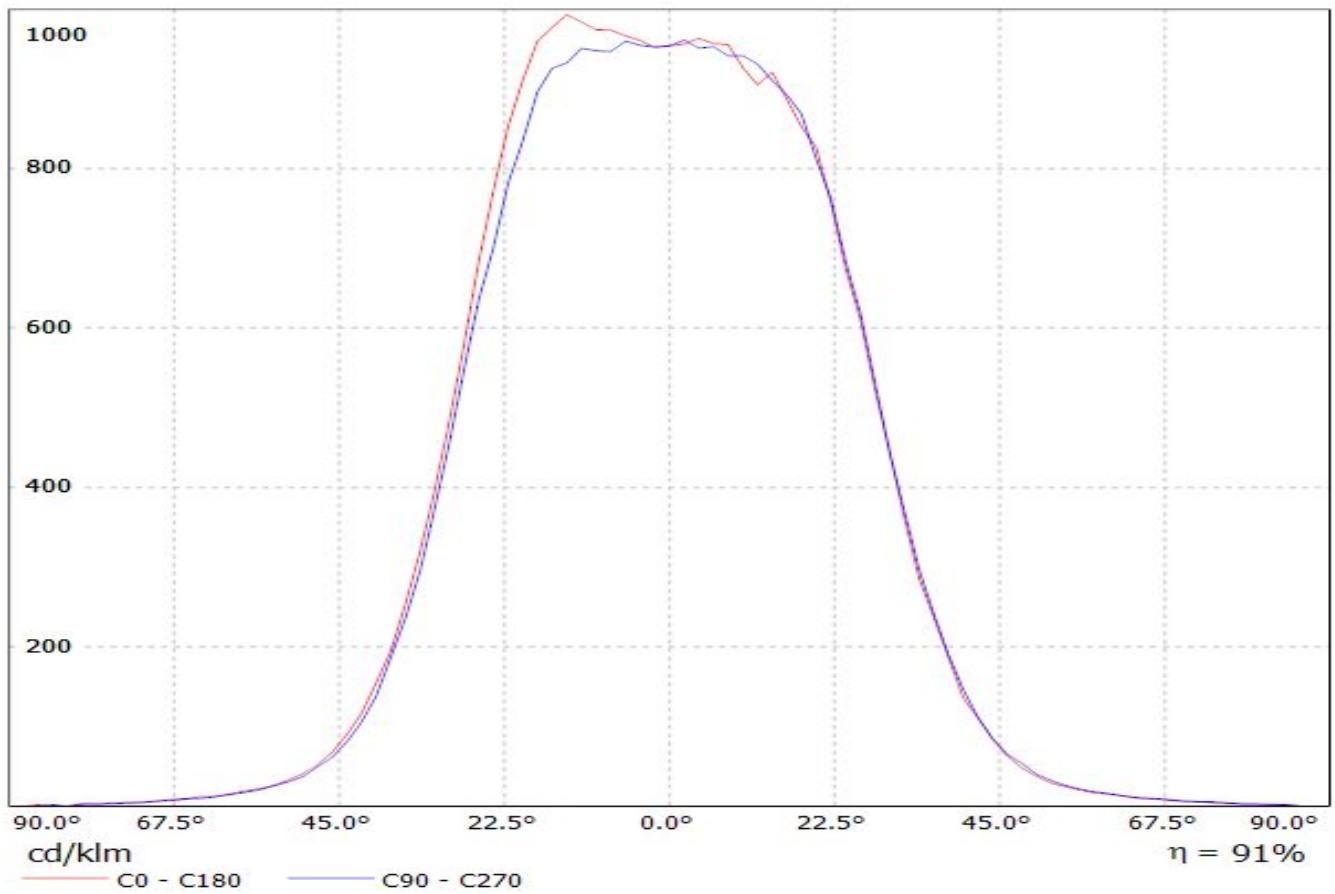

Luminaire: LEDiL Oy C13237\_HB-2X2-WW-BLIND\_(LUXEON\_Q) Eff: 91%  
Lamps: 1 x LUXEON\_Q\_2x2\_(LHQ-3080)\_298.363lm@250mA\_P=2.87385W\_I=249.9mA

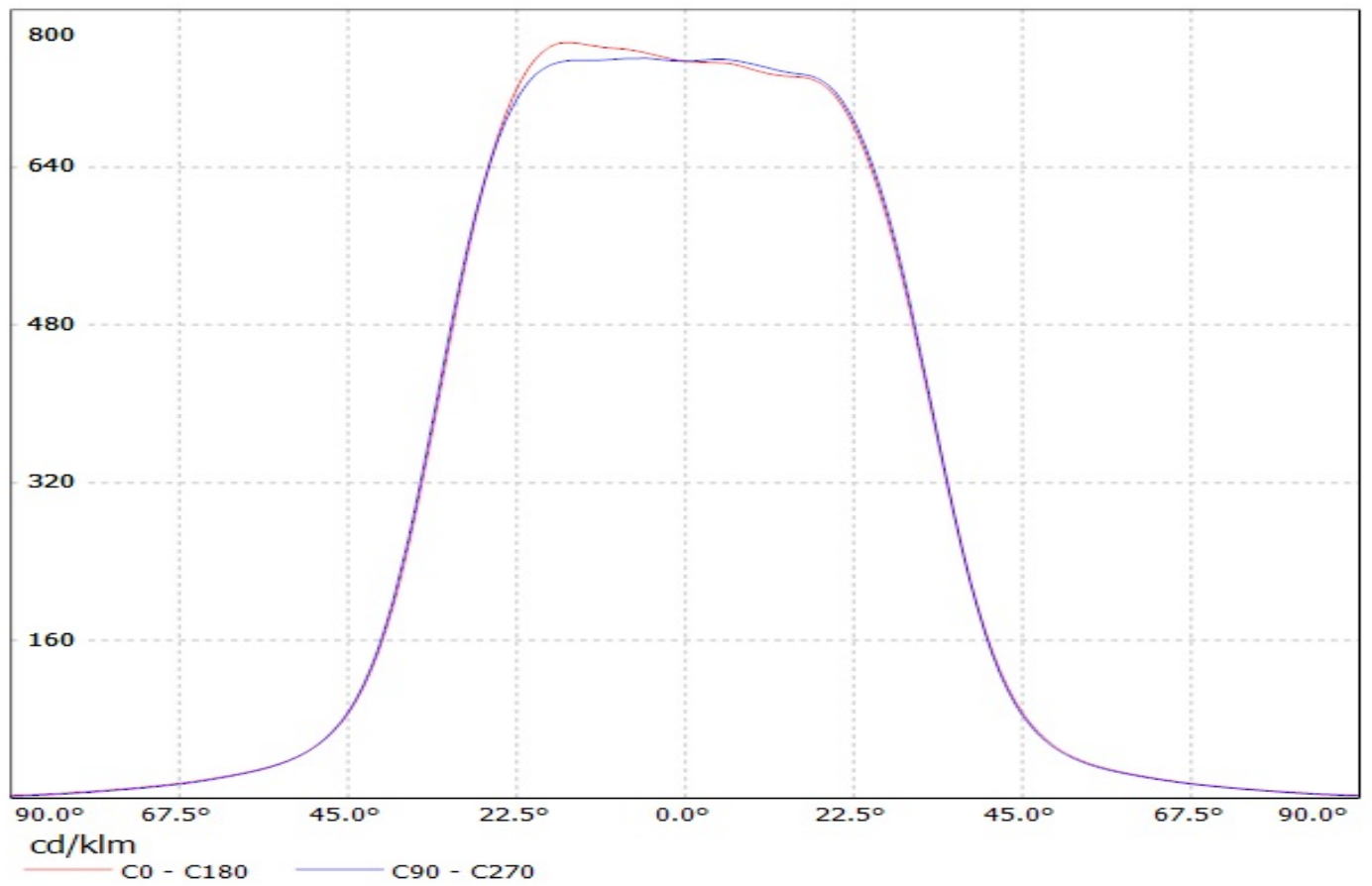



Luminaire: Ledil Oy C13237&C13232\_HB-2X2-WW (Nichia NVS19B 306lm @ 250mA) Efficiency=91%  
Lamps: 1 x Nichia NVS19B 306lm @ 250mA

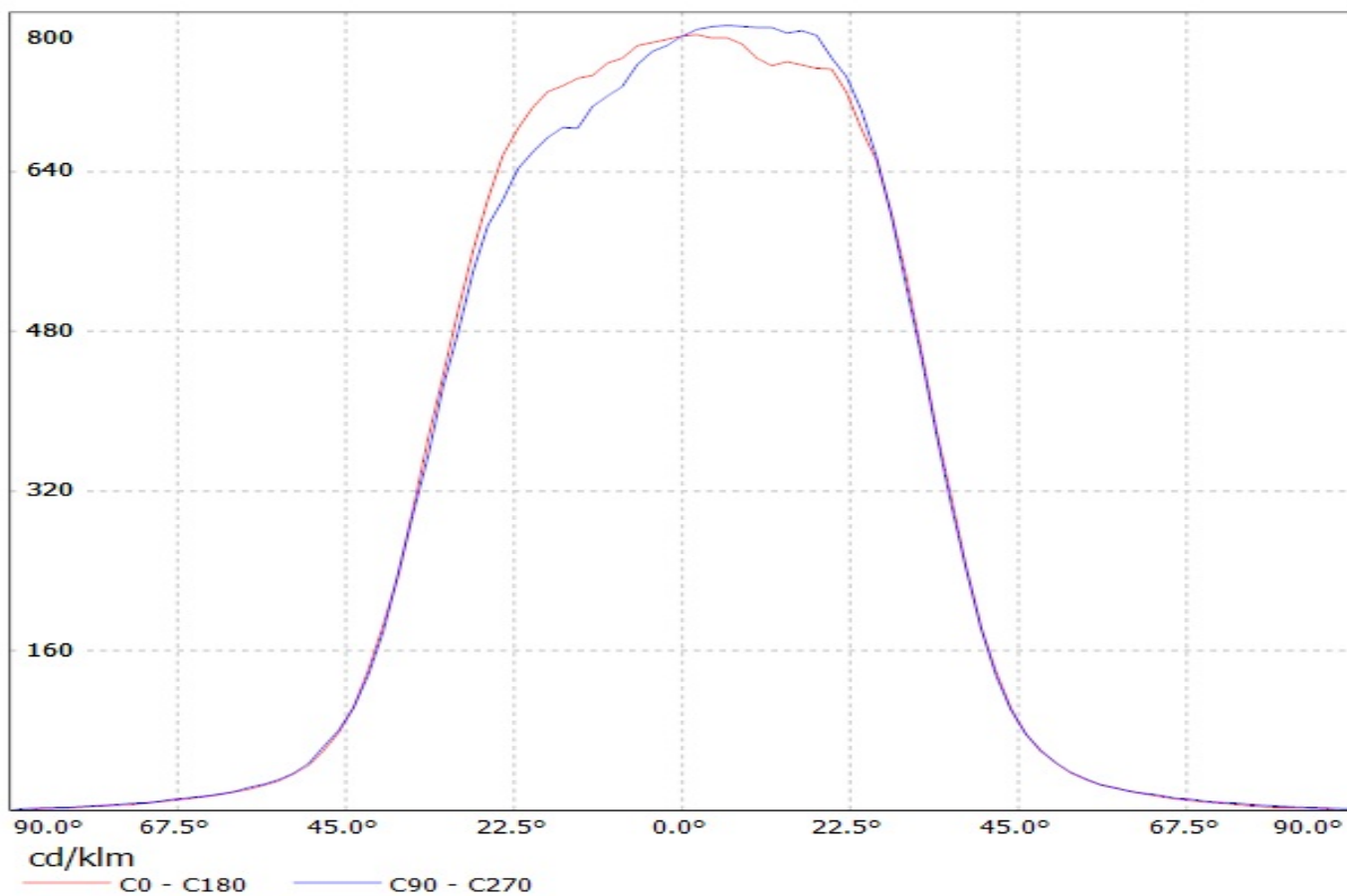

Luminaire: Ledil Oy C13237&C13232\_HB-2X2-WW (Osram Square PC 398lm @ 250mA) Efficiency=91%  
Lamps: 1 x Osram Square PC 398lm @ 250mA

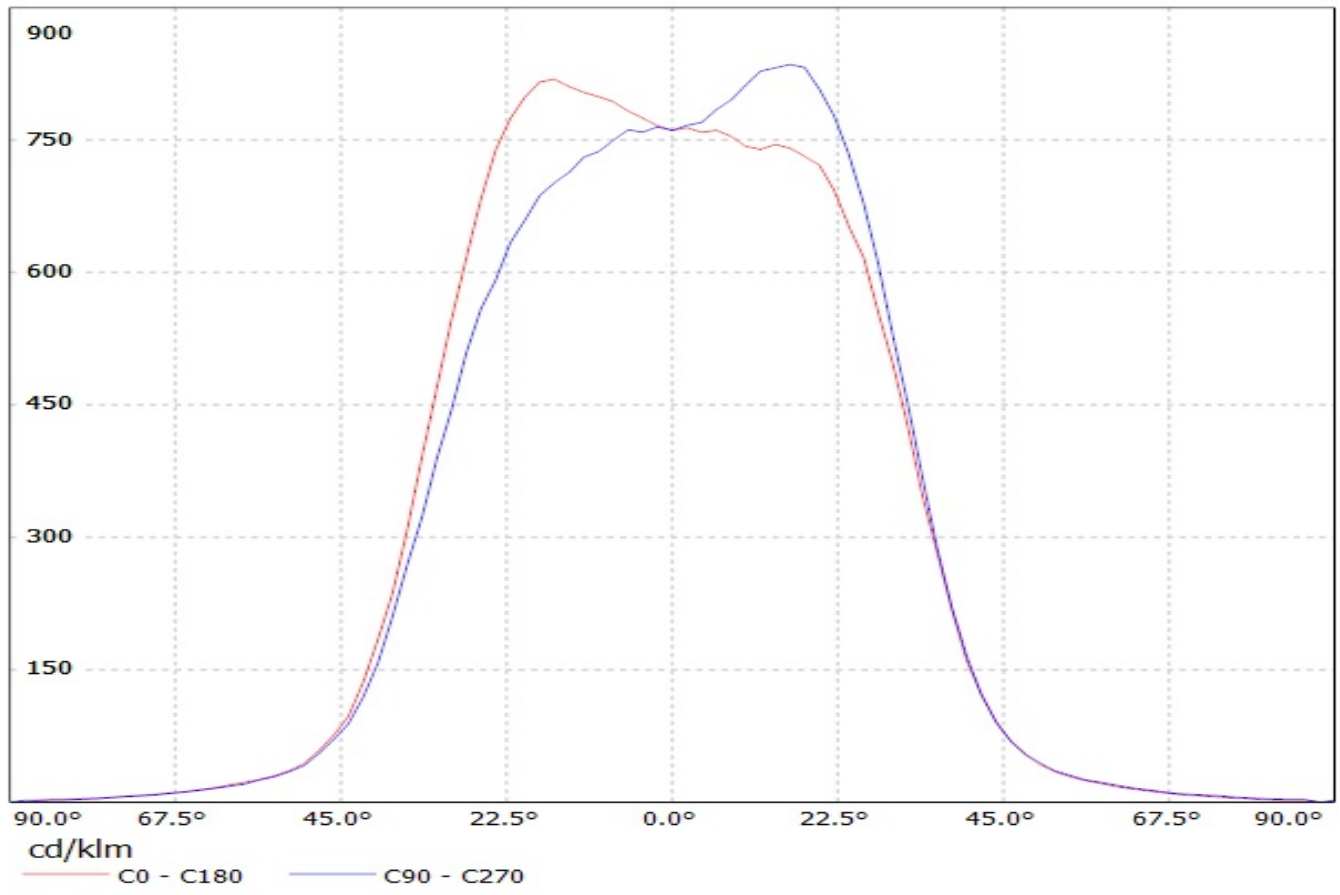

Luminaire: LEDiL Oy C13237\_HB-2X2-WW-BLIND\_(LH351Z) Eff: 89%  
Lamps: 1 x SAMSUNG\_LH351Z\_2x2\_359.49lm@250mA\_P=2.86371W\_I=249.8mA

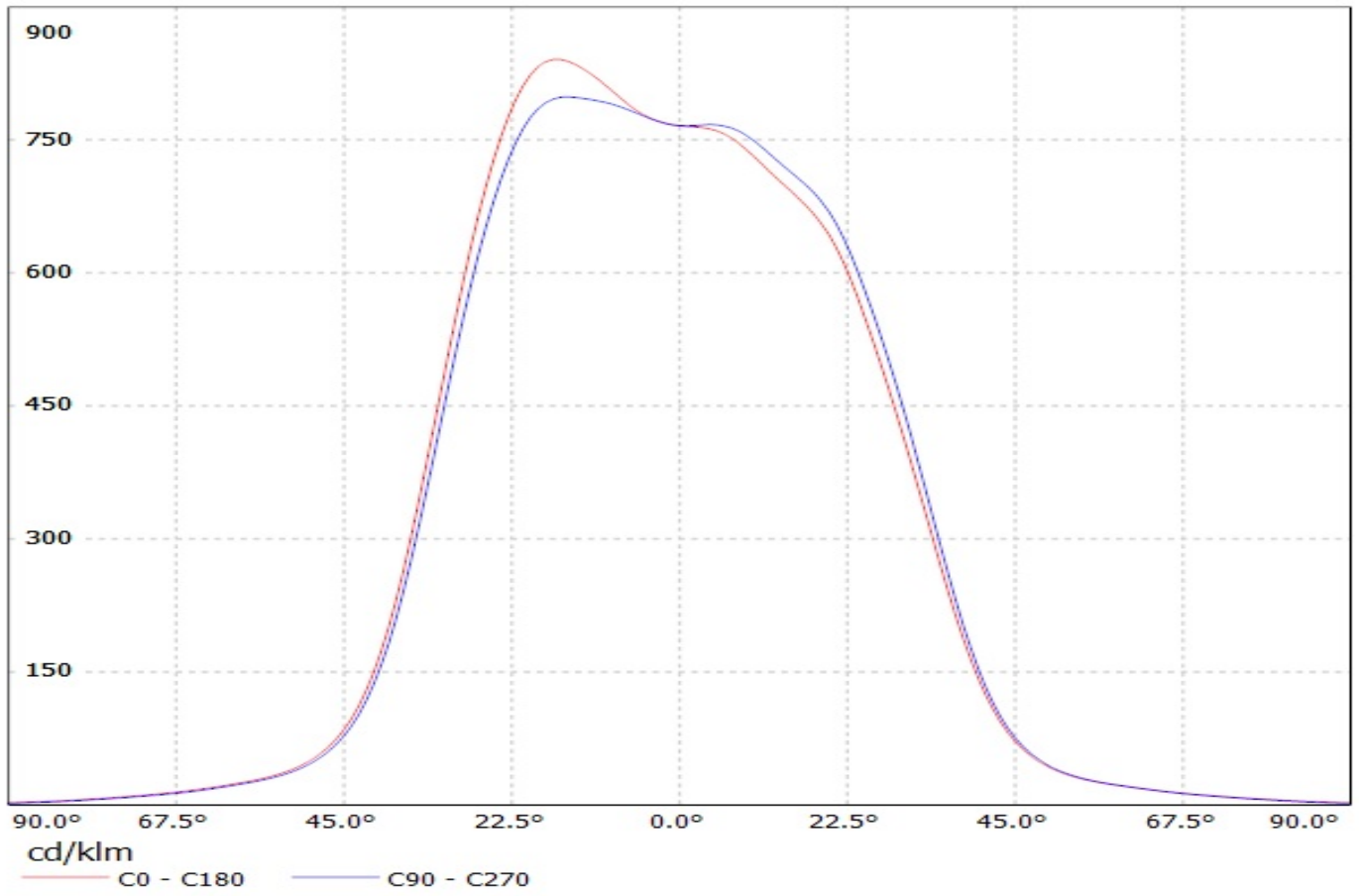

Luminaire: LEDil Oy C13237\_HB-2X2-WW-BLIND\_(Z5M1) Efficiency=90%  
Lamps: 1 x Seoul (SZ5-M1-WN-C8) 379lm @ 250mA CCT=4600K P=2.9W I=250mA

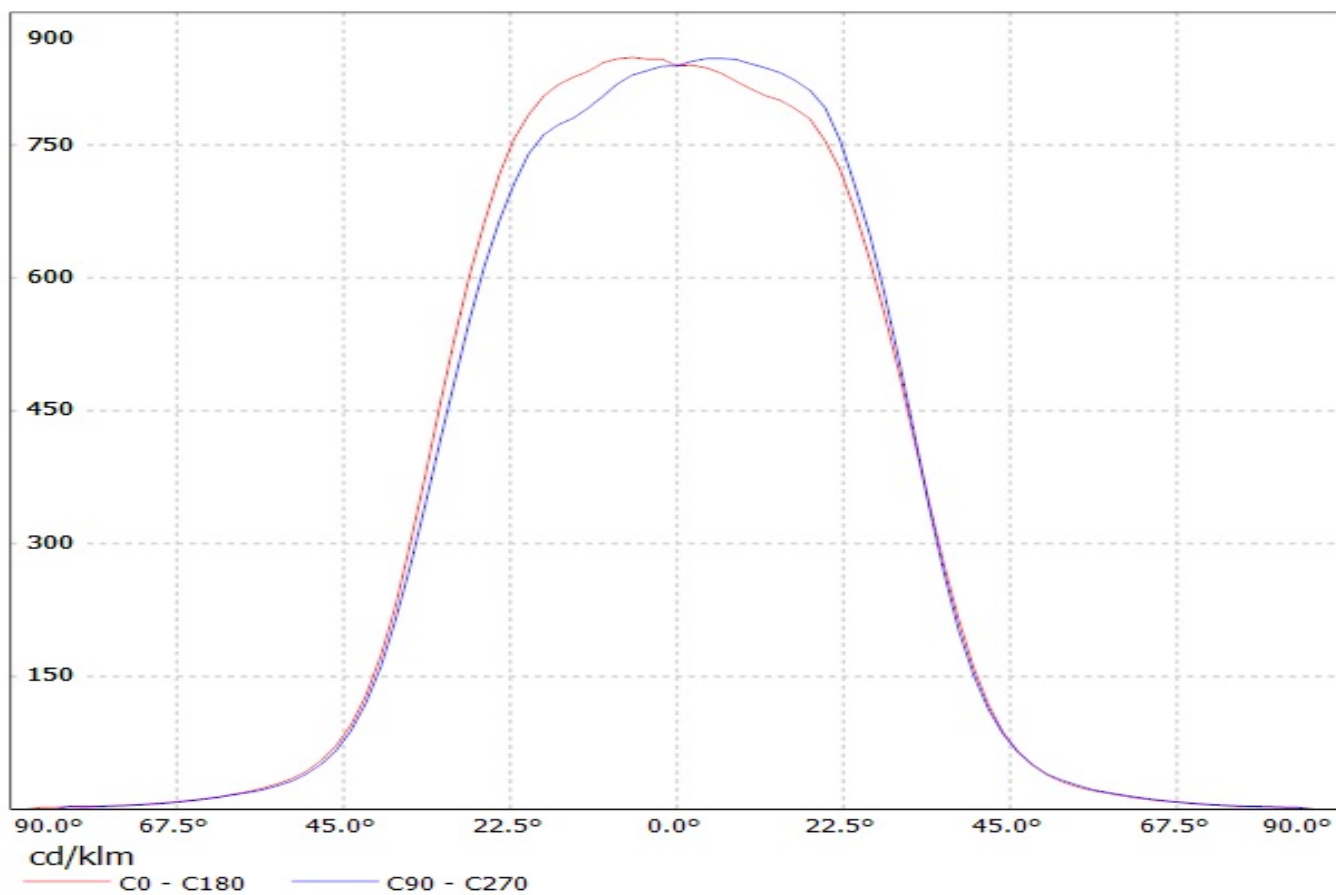

# Ledil C13237\_HB-2X2-WW-BLIND\_(TL1L4) / LDC (Linear)

Luminaire: Ledil C13237\_HB-2X2-WW-BLIND\_(TL1L4)

Lamps: 1 x Toshiba\_TL1L4\_2x2\_(TL1L4-DW0)\_472.639lm@250mA\_CCT=6500K\_P=2.9W\_I=0.25A

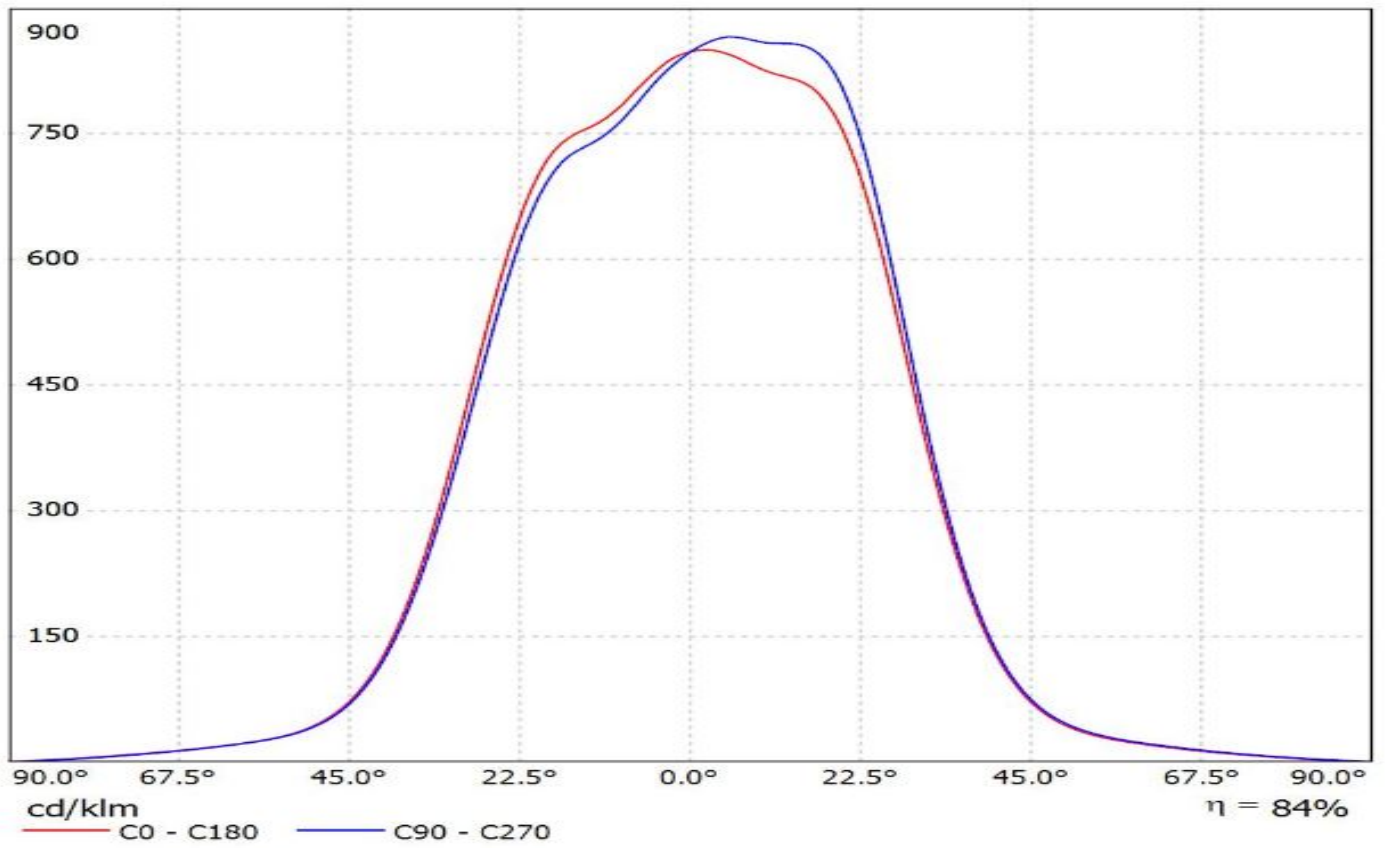

Luminaire: LEDiL Oy C13237\_HB-2X2-WW-BLIND\_(Tridonic\_Module\_RLE\_G1)  
Lamps: 1 x Tridonic\_Module\_RLE\_G1\_4576.03lm@700mA\_P=32.0681W\_η=0.700A

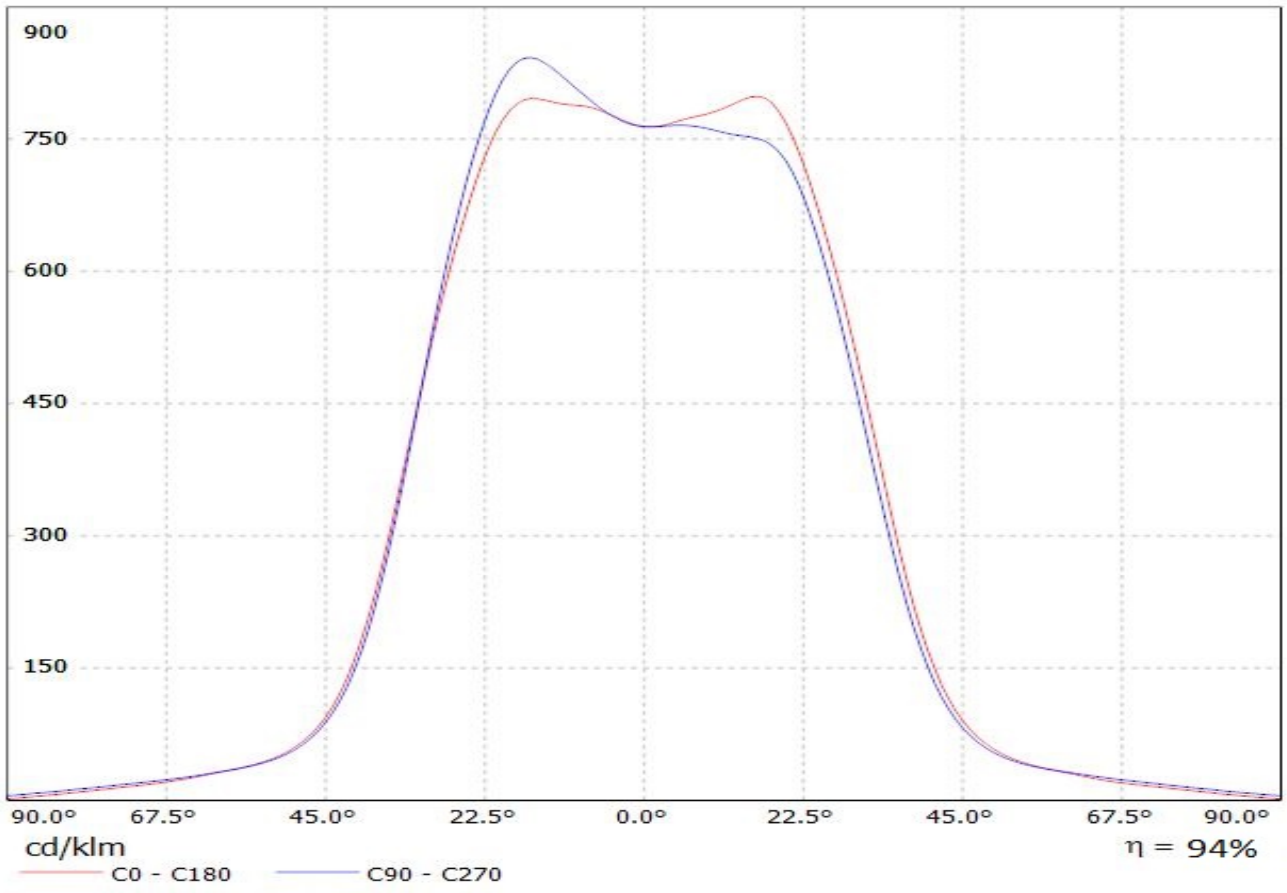

Luminaire: LEDiL Oy C13237\_HB-2X2-WW-BLIND\_(Tridonic\_Module\_RLE\_G1)  
Lamps: 2 x Tridonic\_Module\_RLE\_G1\_2288lm@700mA\_P=16W\_I=0.700A

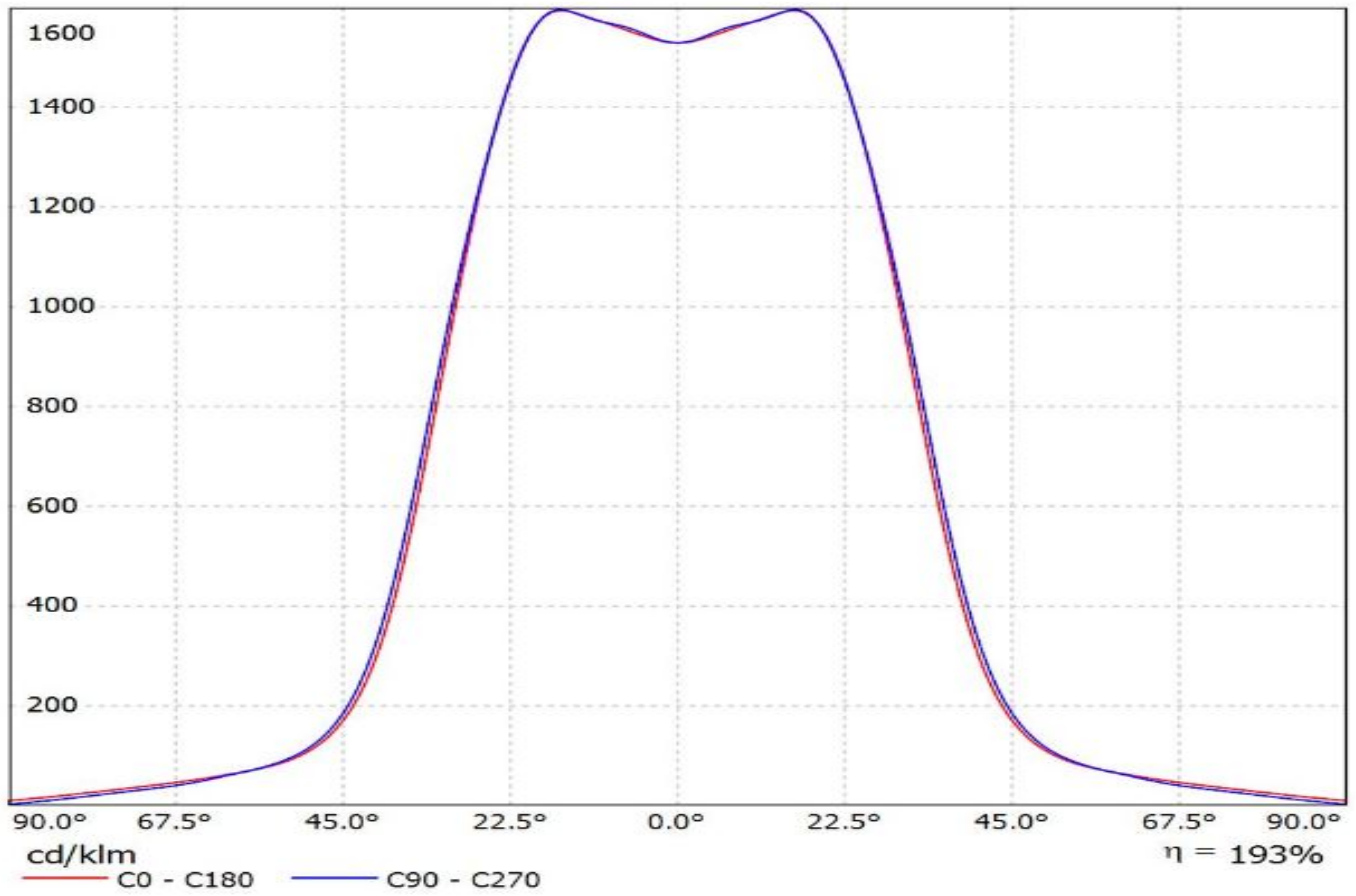

Luminaire: LEDiL Oy C13237\_HB-2X2-WW-BLIND\_(Tridonic\_Module\_RLE\_G1)  
Lamps: 2 x Tridonic\_Module\_RLE\_G1\_2288lm@700mA\_P=16W\_I=0.700A

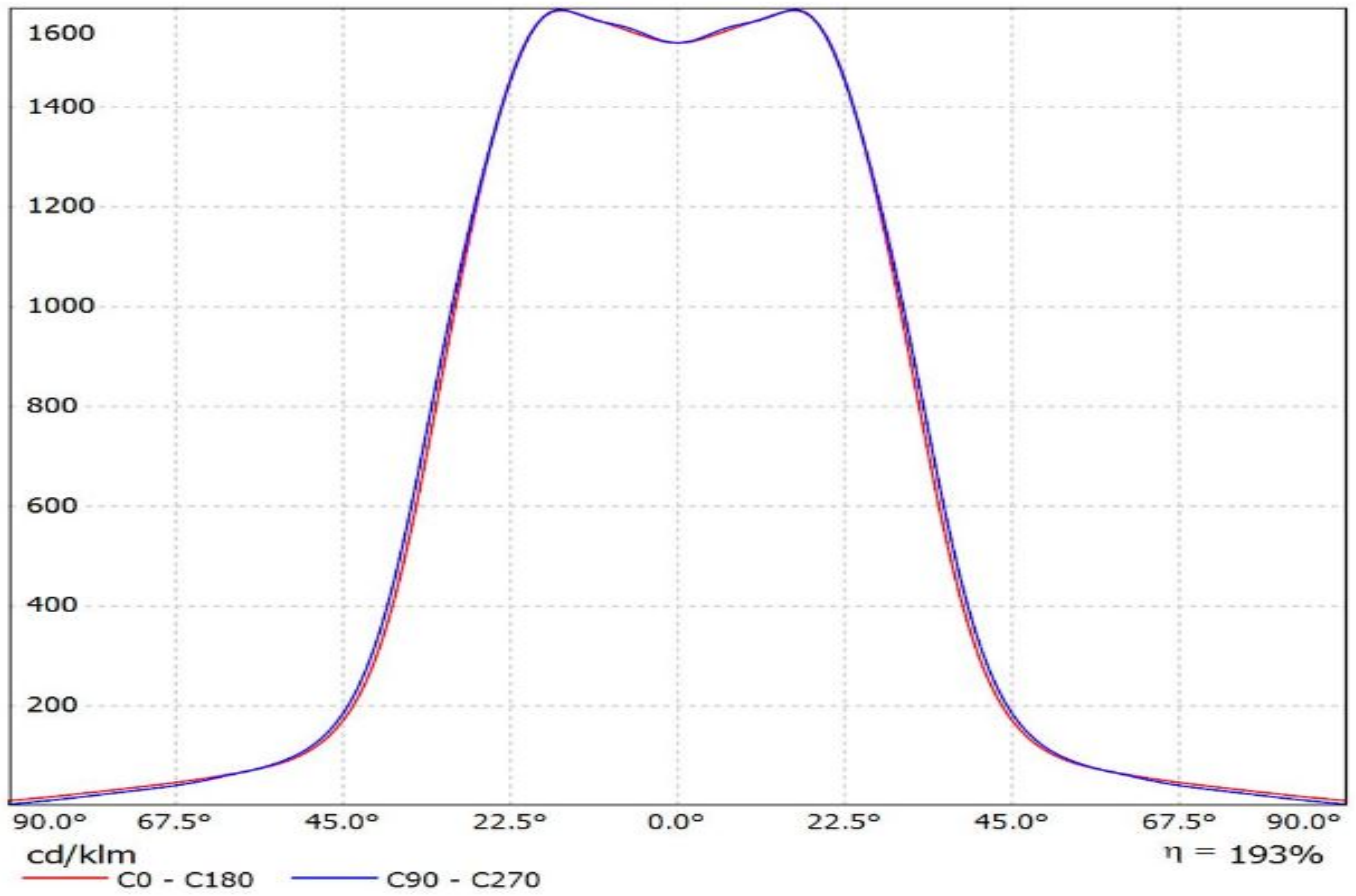



Luminaire: LEDiL Oy C13237\_HB-2X2-WW-BLIND\_(Tridonic\_Module\_RLE\_G1)  
Lamps: 1 x Tridonic\_Module\_RLE\_G1\_4576.03lm@700mA\_P=32.0681W\_I=0.700A

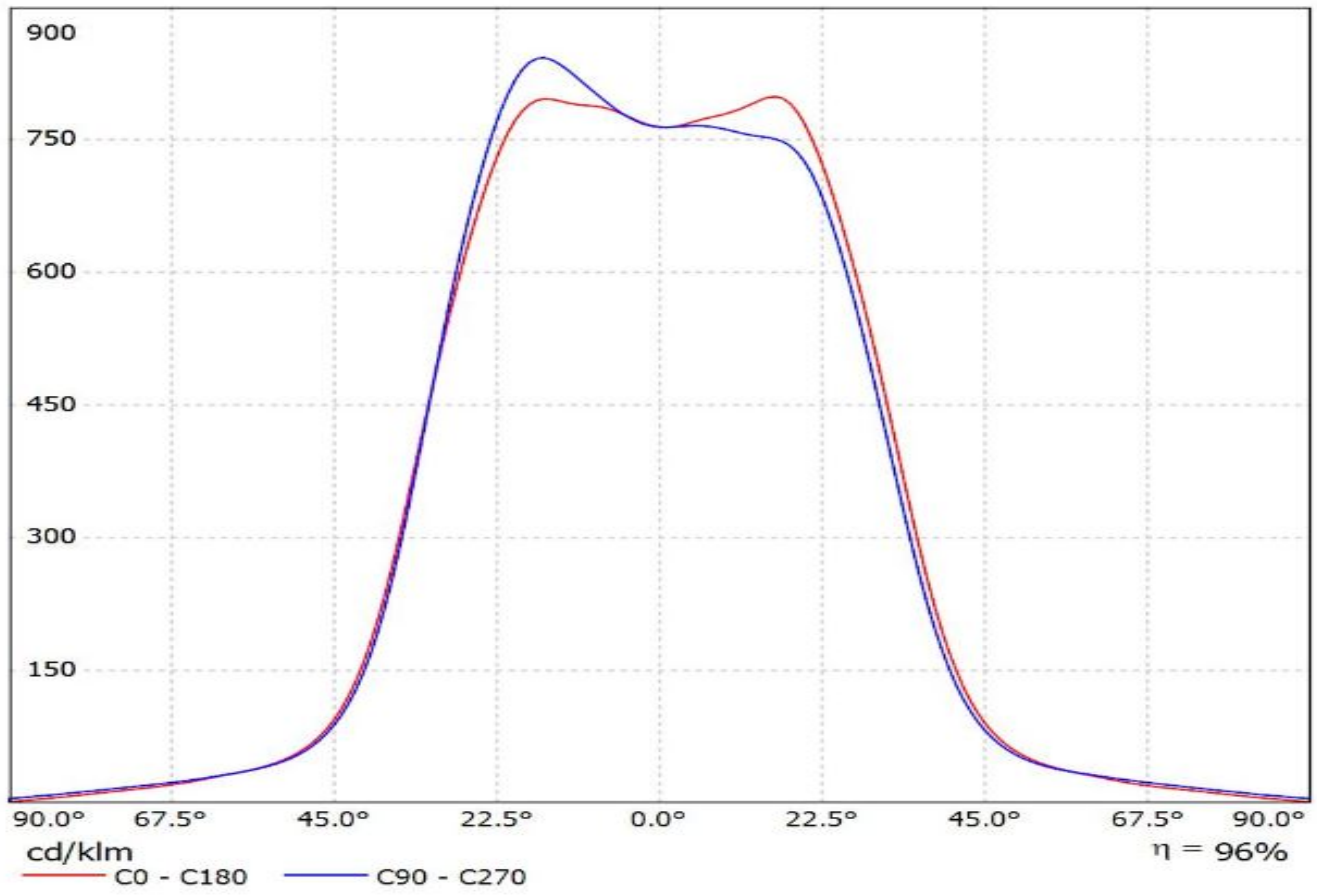

Luminaire: Ledil Oy C13237&C13232\_HB-2X2-WW (Cree XT-E 390lm @ 250mA) Efficiency=91%  
Lamps: 1 x Cree XT-E 390lm @ 250mA

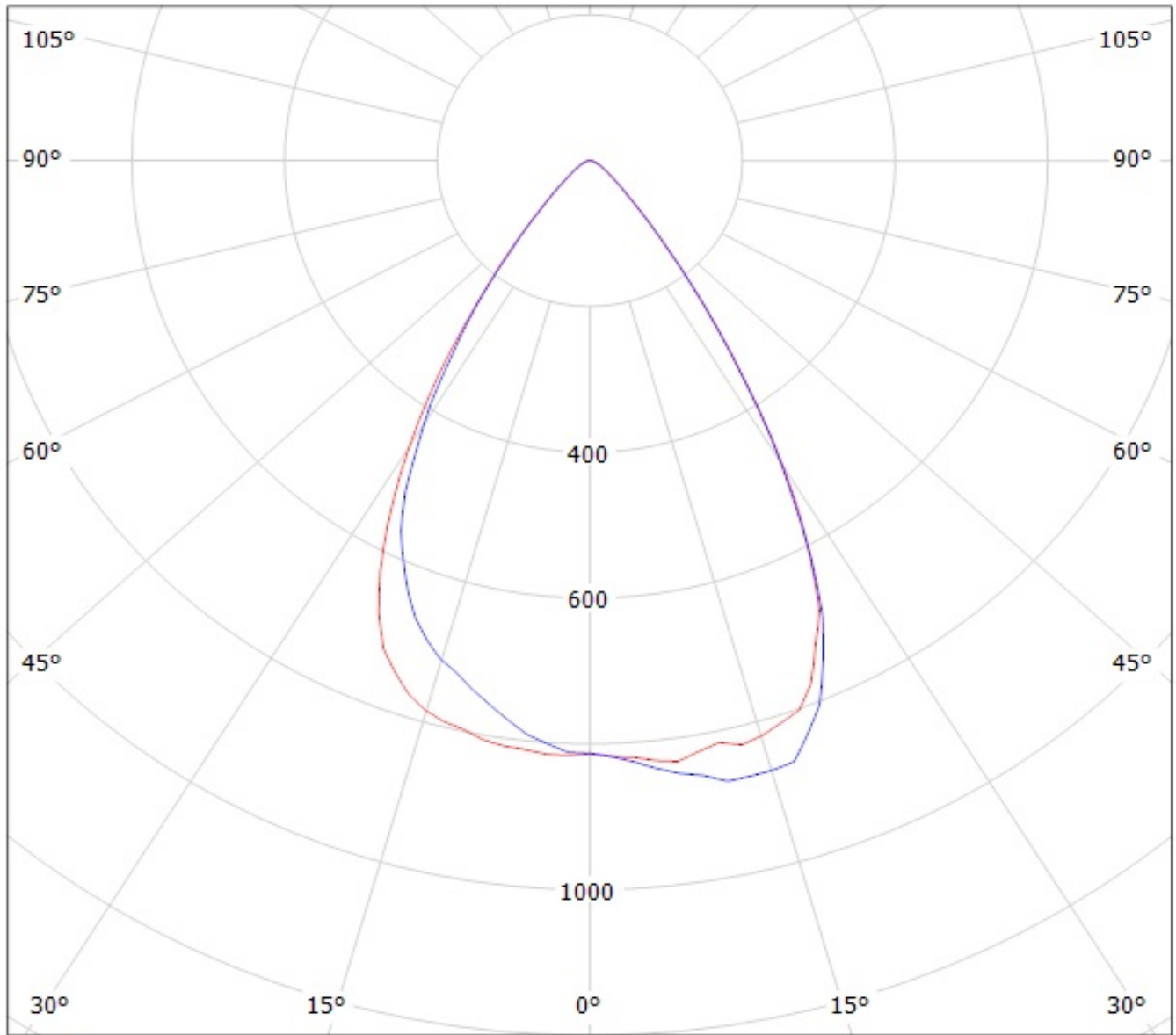

cd/klm

— C0 - C180    — C90 - C270

Luminaire: Ledil Oy C13237&C13232\_HB-2X2-WW (Cree XP-G 257lm @ 250mA) Efficiency=91%  
Lamps: 1 x Cree XP-G 257lm @ 250mA

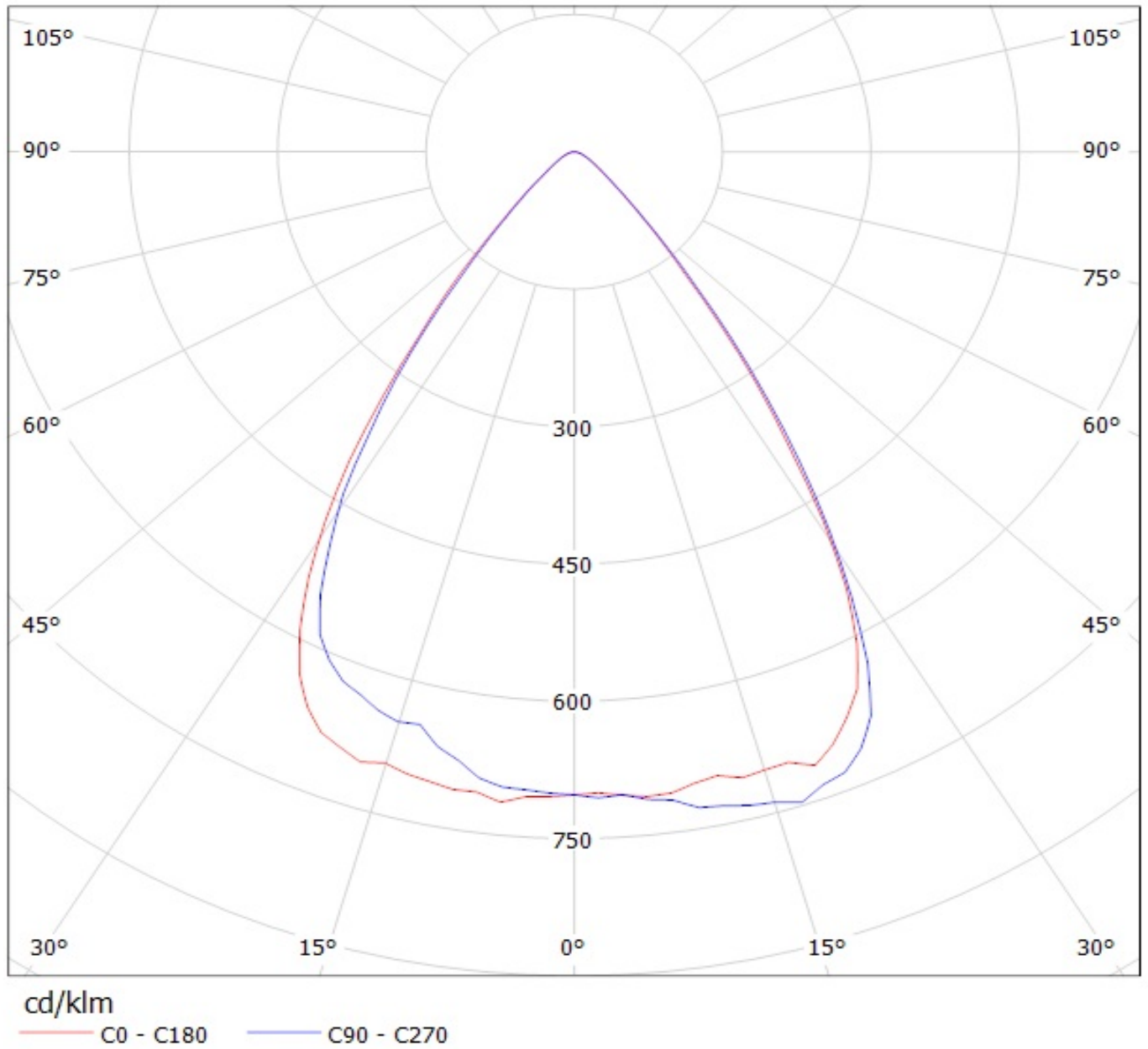

Luminaire: Ledil Oy C13237&C13232\_HB-2X2-WW (Cree XP-G2 420lm @ 250mA) Efficiency=91%  
Lamps: 1 x Cree XP-G2 420lm @ 250mA

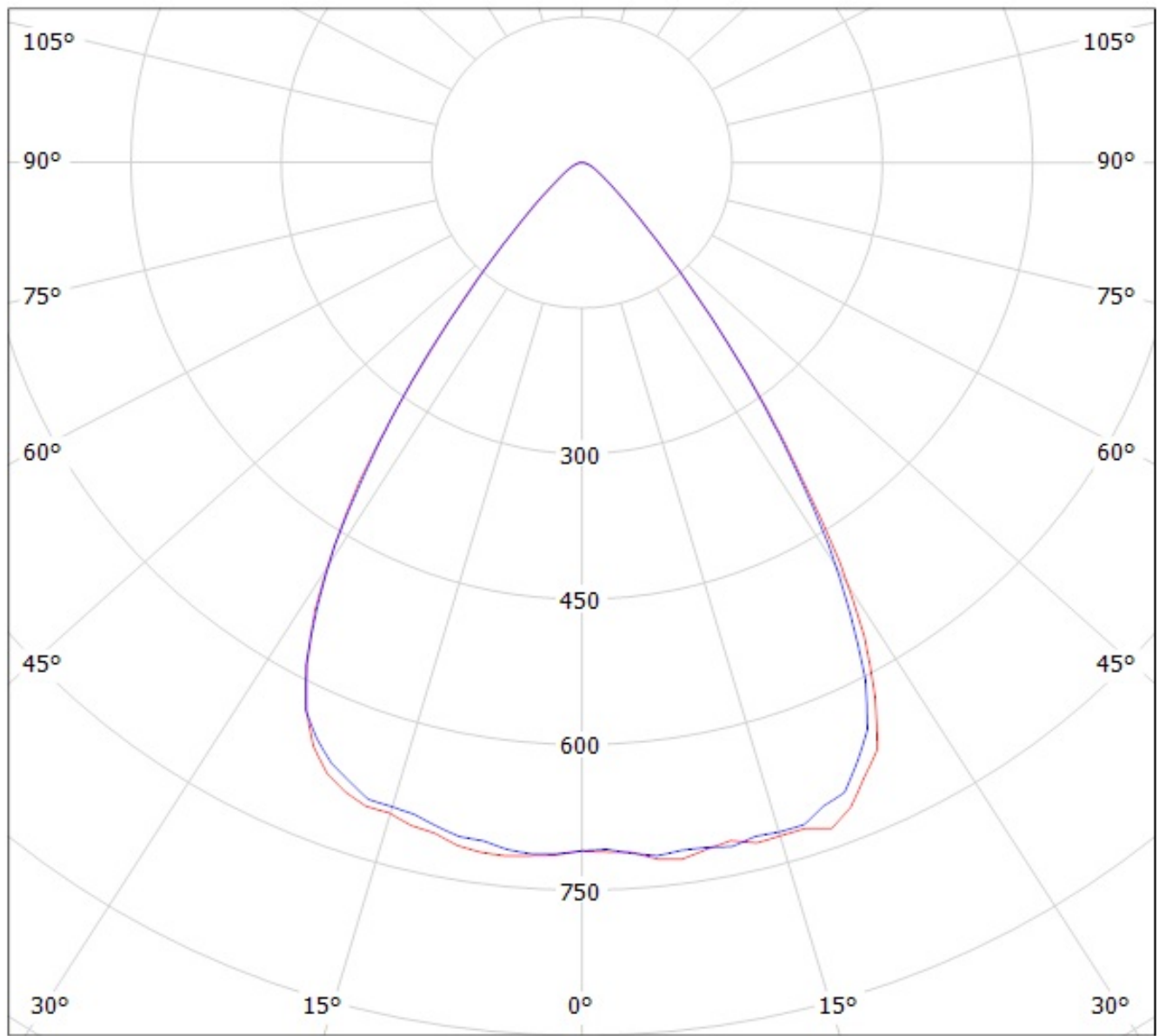

cd/klm

— C0 - C180

— C90 - C270

Luminaire: Ledil Oy C13237\_HB-2X2-WW-BLIND\_(3535\_Ceramic\_gen2) Efficiency=86%  
Lamps: 1 x LG 3535 Ceramic gen2 (PKG5700K) 461lm @ 250mA CCT=6600K P=2.9W I=250mA

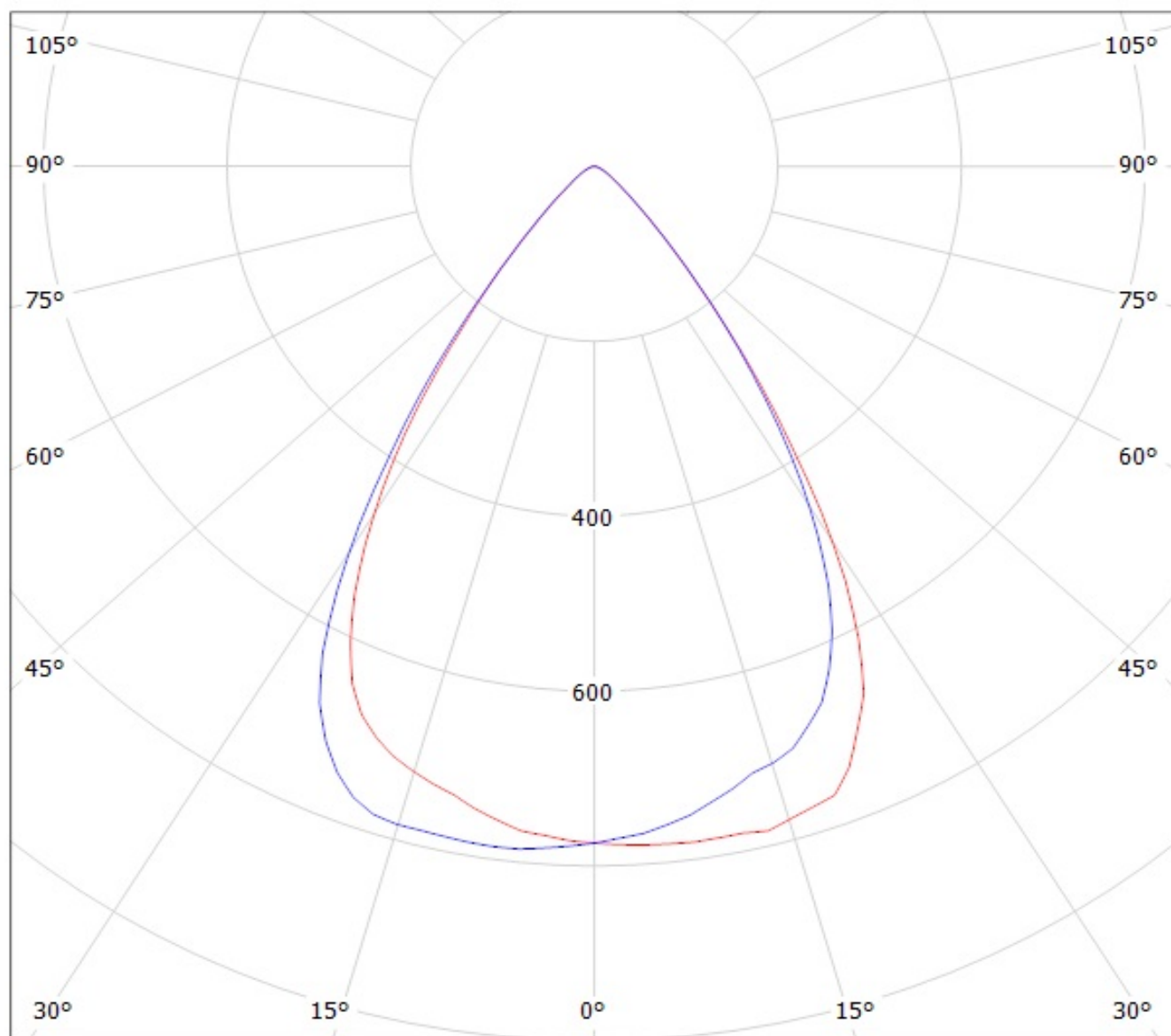

cd/klm

— C0 - C180

— C90 - C270

Luminaire: Ledil Oy C13237\_HB-2X2-WW-BLIND\_(Luxeon\_Z\_ES) Efficiency=90%  
Lamps: 1 x Luxeon Z ES (LXZ2-3090) 209lm @ 250mA CCT=3000k P=2.8W I=250mA

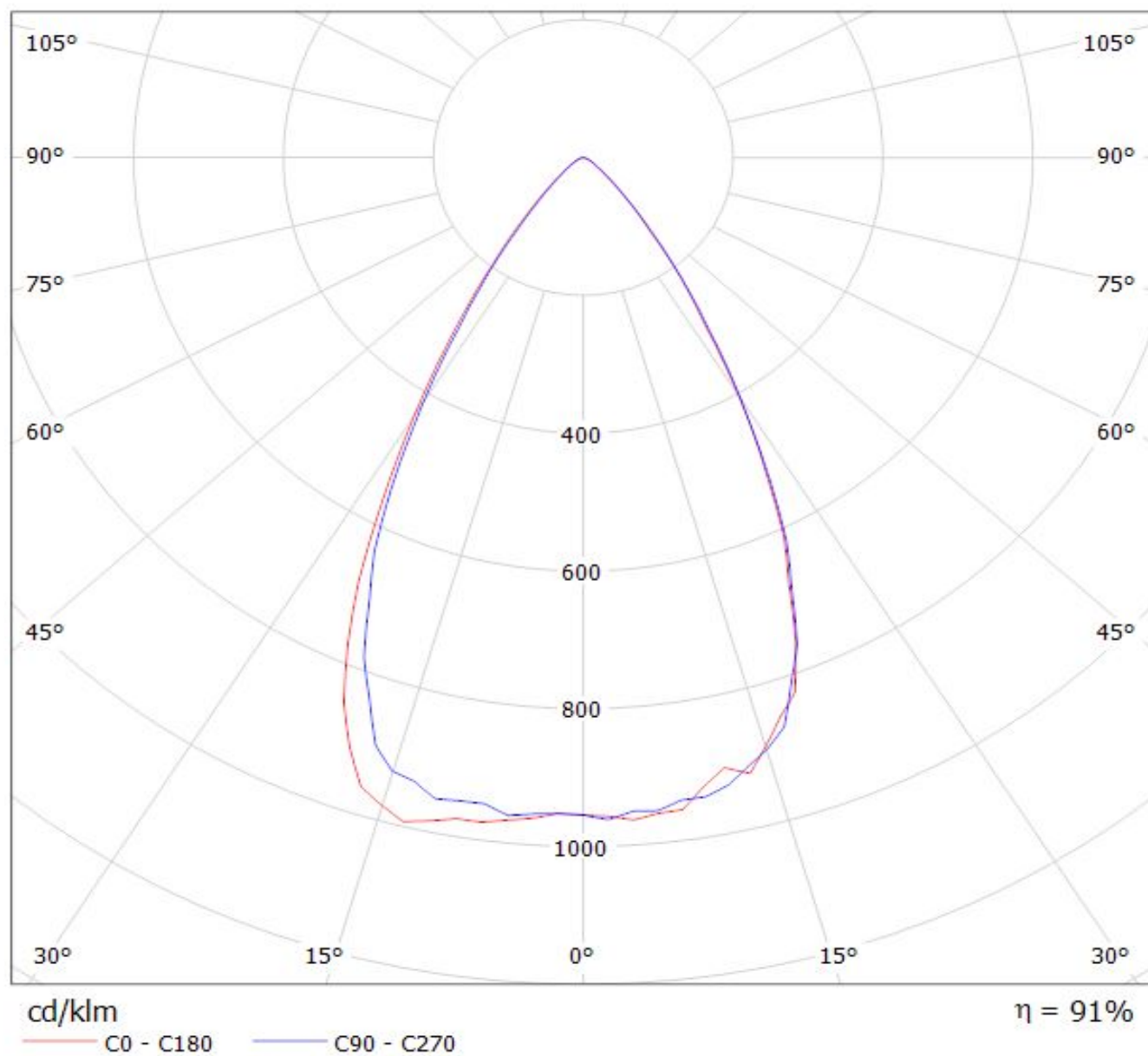

Luminaire: LEDiL Oy C13237\_HB-2X2-WW-BLIND\_(LUXEON\_Q) Eff. 91%

Lamps: 1 x LUXEON\_Q\_2x2\_(LHQ-3080)\_298.363lm@250mA\_P=2.87385W\_I=249.9mA

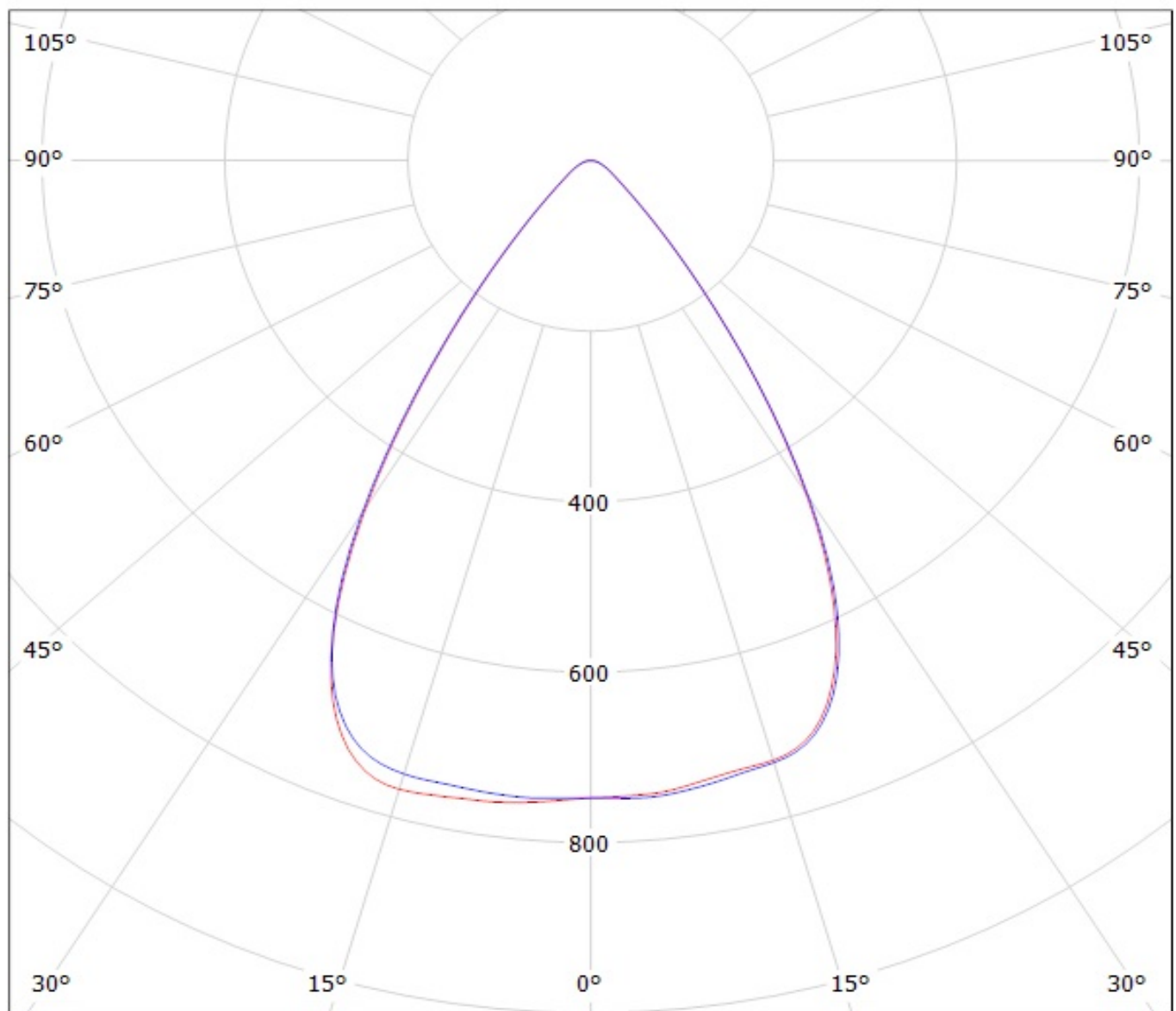

cd/klm

— C0 - C180

— C90 - C270

Luminaire: Ledil Oy C13237&C13232\_HB-2X2-WW (Nichia NVS19B 306lm @ 250mA) Efficiency=91%  
Lamps: 1 x Nichia NVS19B 306lm @ 250mA

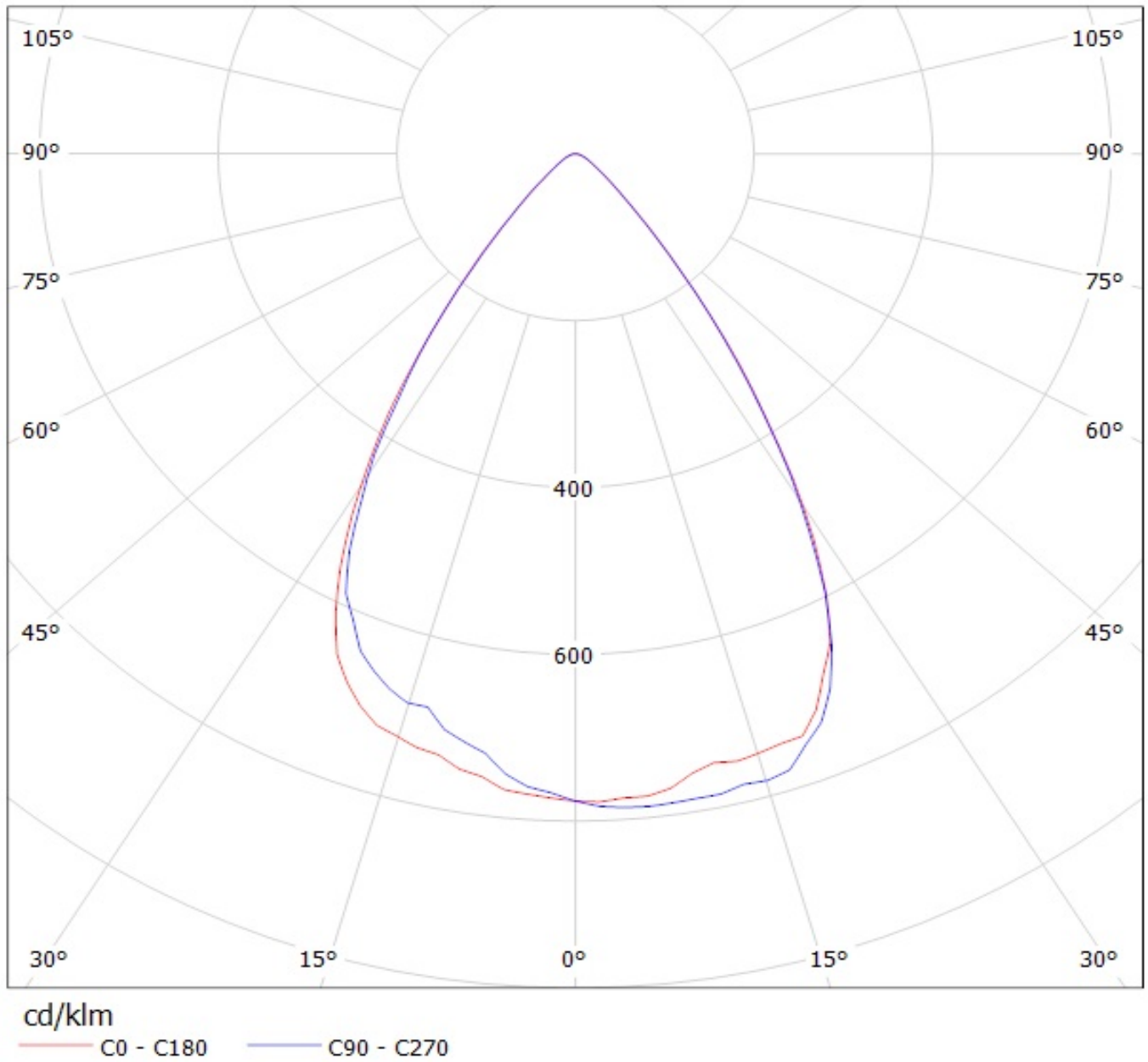



Luminaire: Ledil Oy C13237&C13232\_HB-2X2-WW (Osram Square PC 398lm @ 250mA) Efficiency=91%  
Lamps: 1 x Osram Square PC 398lm @ 250mA

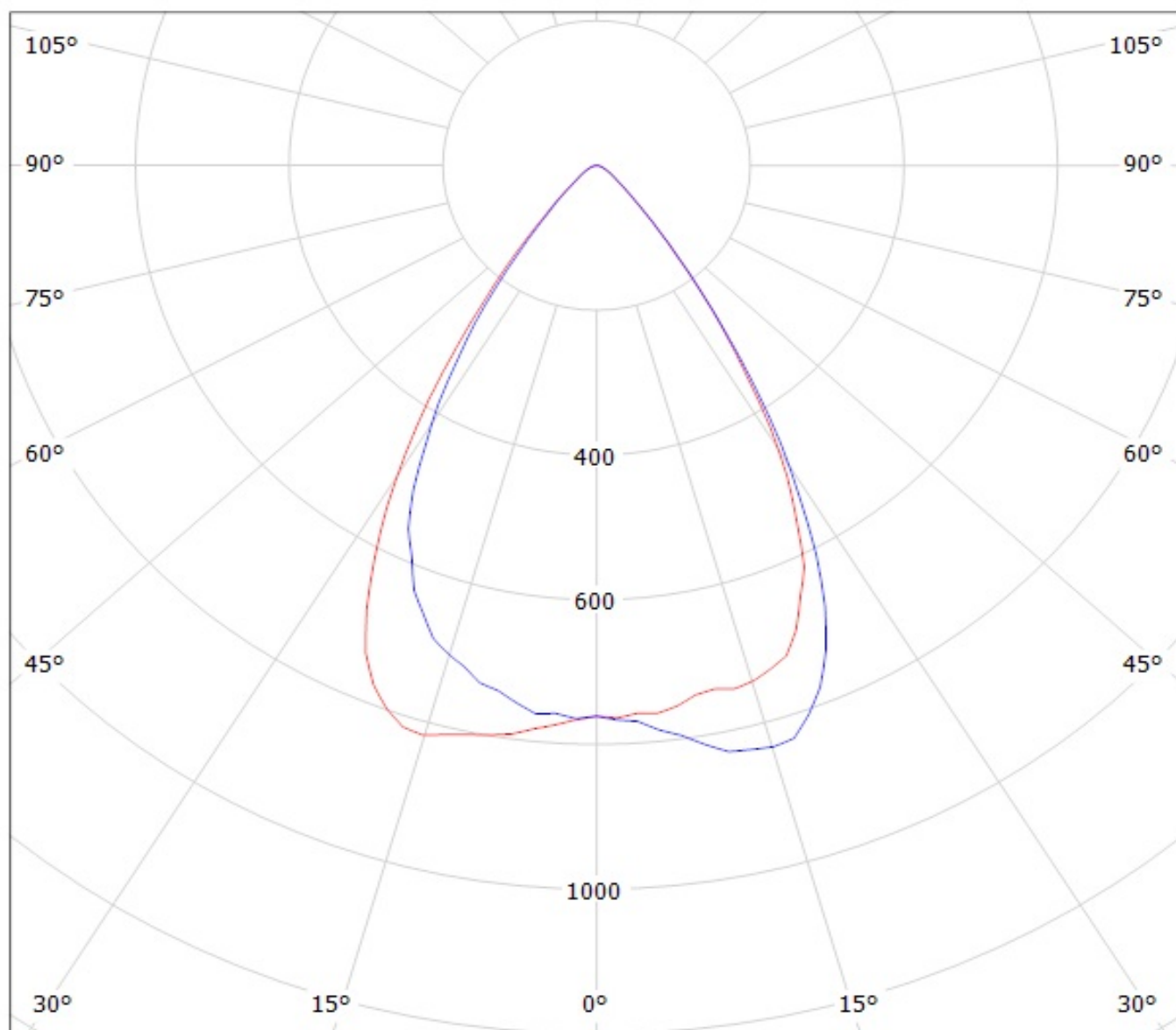

cd/klm

— C0 - C180

— C90 - C270

Luminaire: LEDiL Oy C13237\_HB-2X2-WW-BLIND\_(LH351Z) Eff: 89%  
Lamps: 1 x SAMSUNG\_LH351Z\_2x2\_359.49lm@250mA\_P=2.86371W\_I=249.8mA

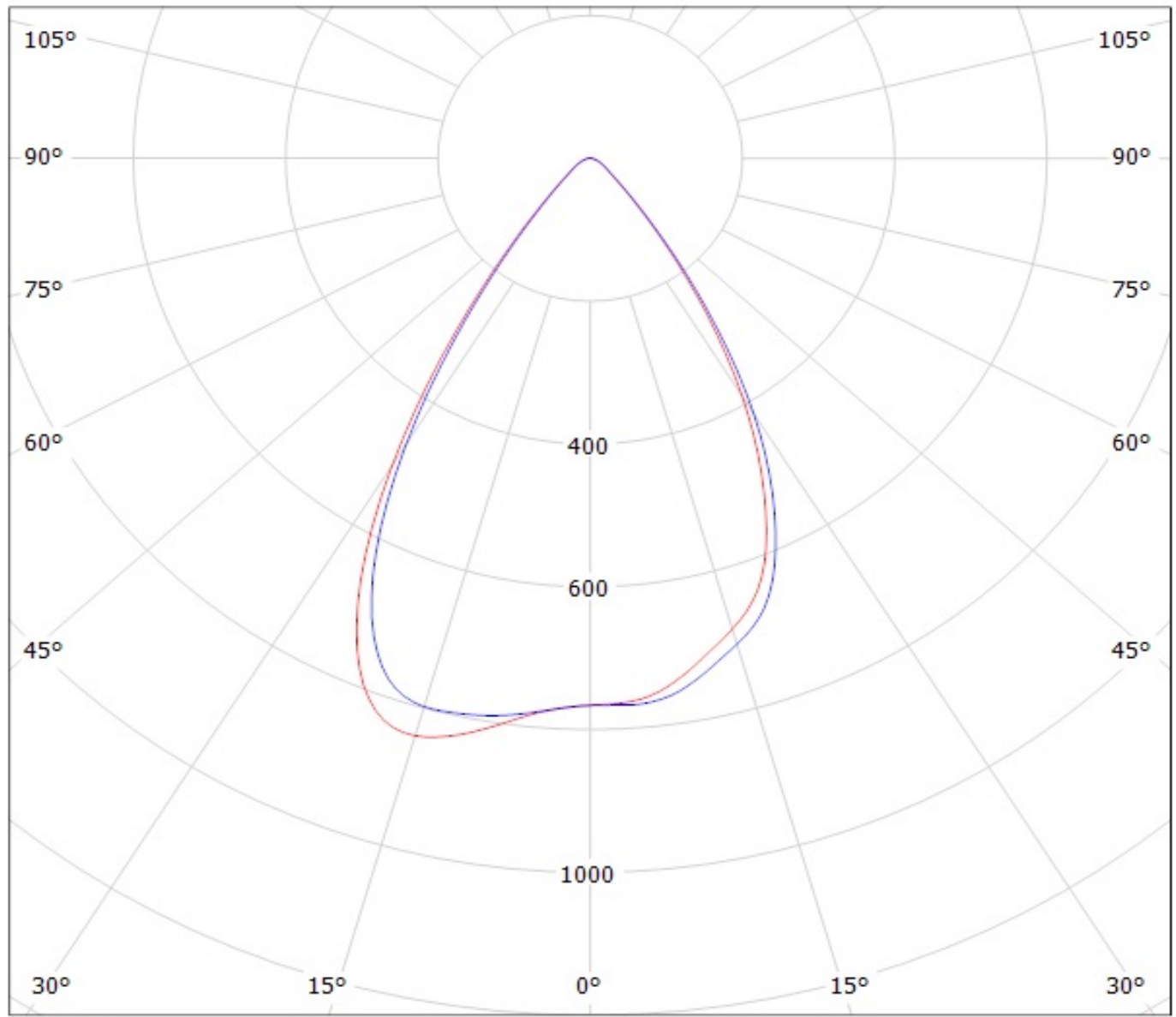

cd/klm

— C0 - C180

— C90 - C270

Luminaire: LEDil Oy C13237\_HB-2X2-WW-BLIND\_(Z5M1) Efficiency=90%  
Lamps: 1 x Seoul (SZ5-M1-WN-C8) 379lm @ 250mA CCT=4600K P=2.9W I=250mA

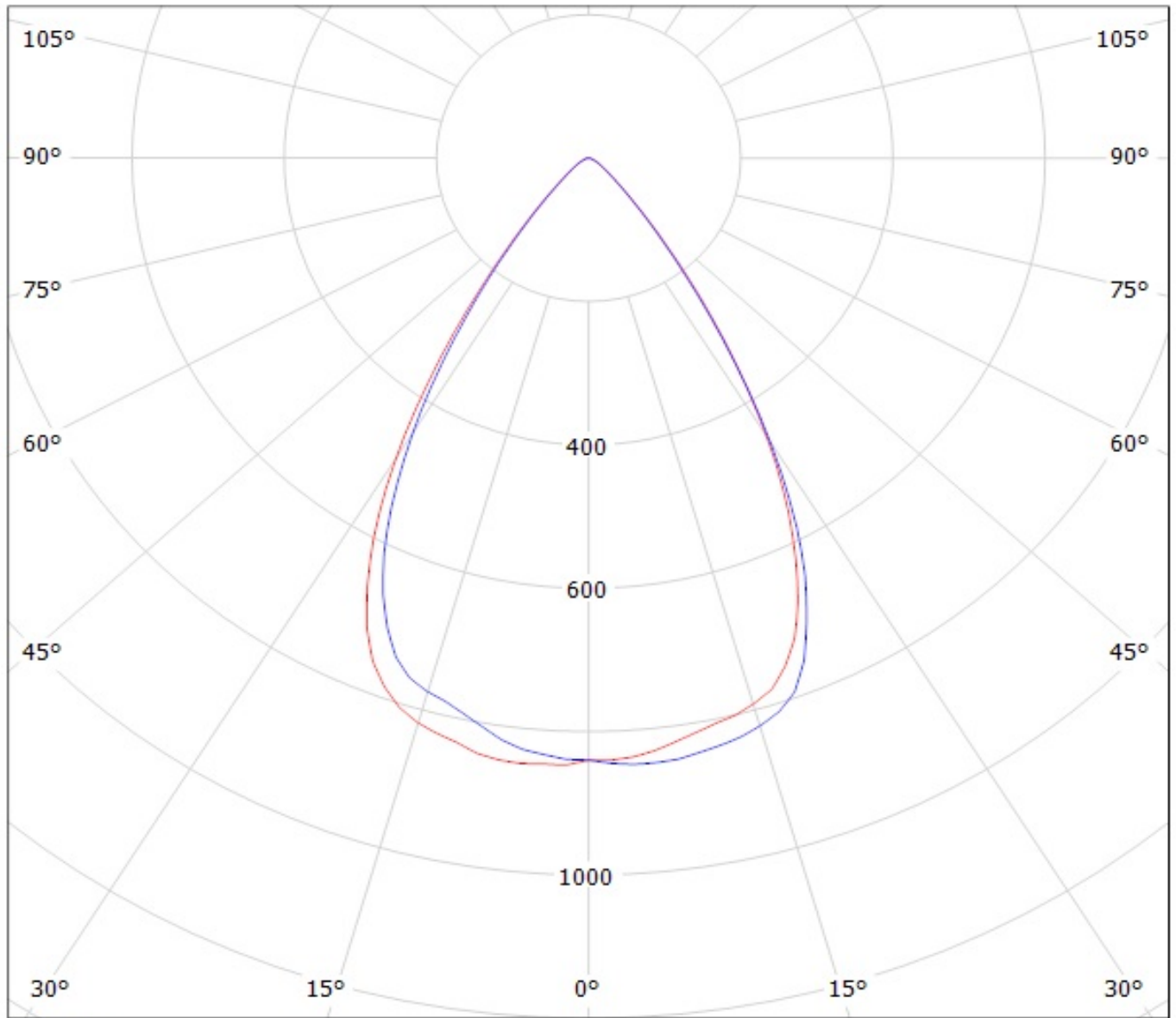

cd/klm

— C0 - C180    — C90 - C270

# Ledil C13237\_HB-2X2-WW-BLIND\_(TL1L4) / LDC (Polar)

Luminaire: Ledil C13237\_HB-2X2-WW-BLIND\_(TL1L4)

Lamps: 1 x Toshiba\_TL1L4\_2x2\_(TL1L4-DW0)\_472.639lm@250mA\_CCT=6500K\_P=2.9W\_I=0.25A

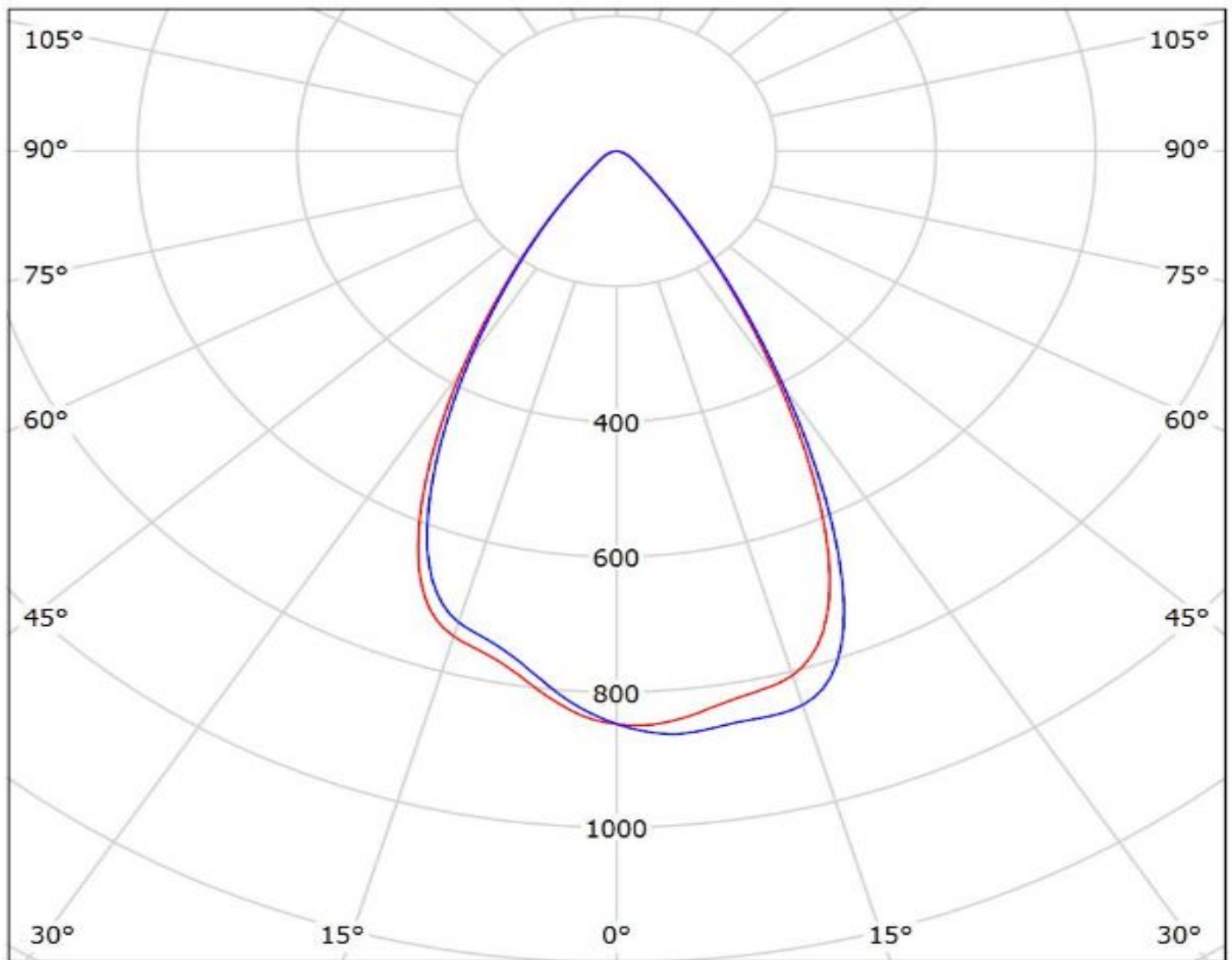

cd/klm

— C0 - C180 — C90 - C270

$\eta = 84\%$

Luminaire: LEDiL Oy C13237\_HB-2X2-WW-BLIND\_(Tridonic\_Module\_RLE\_G1)  
Lamps: 1 x Tridonic\_Module\_RLE\_G1\_4576.03lm@700mA\_P=32.0681W\_I=0.700A

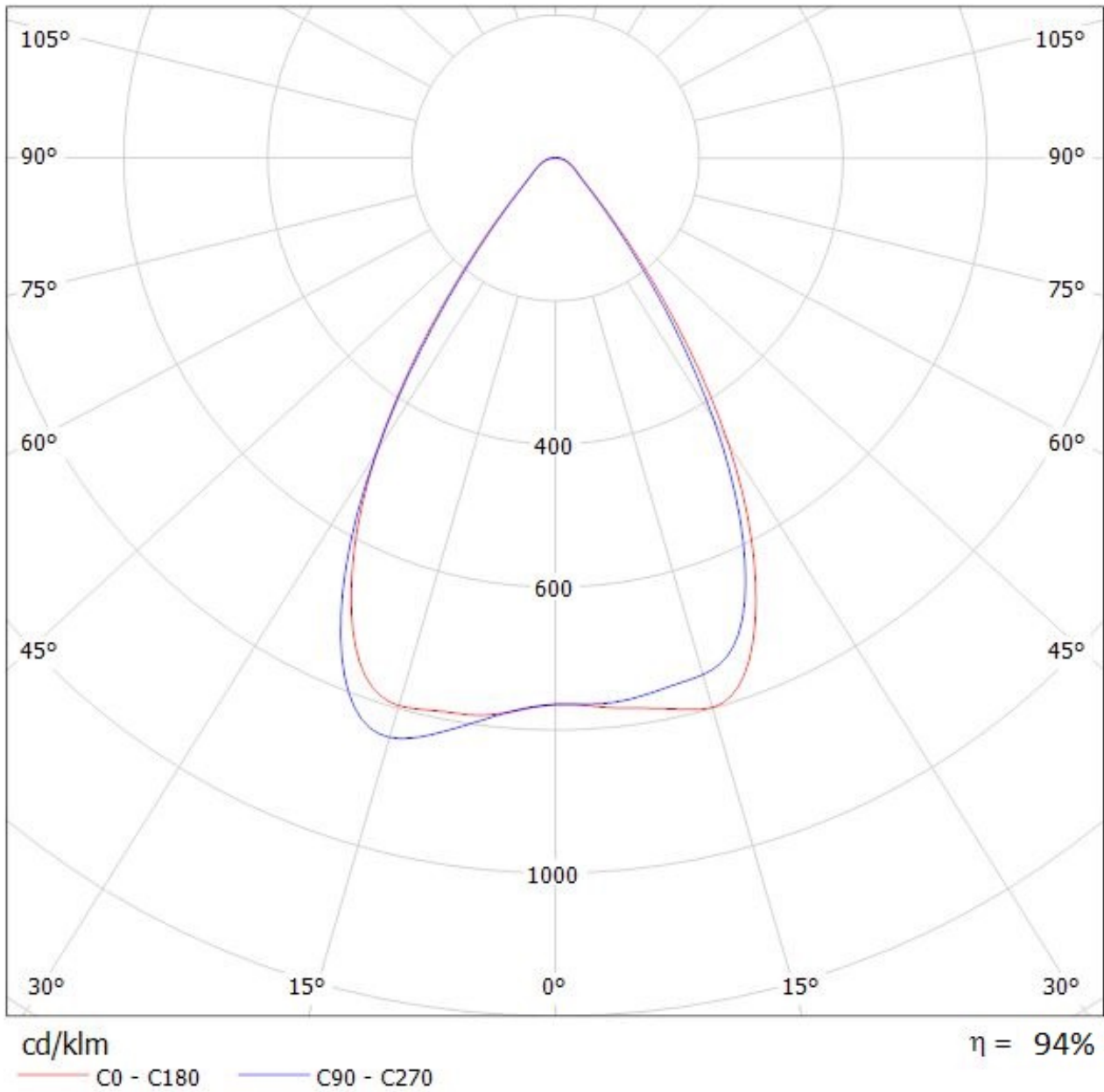

Luminaire: LEDiL Oy C13237\_HB-2X2-WW-BLIND\_(Tridonic\_Module\_RLE\_G1)  
Lamps: 2 x Tridonic\_Module\_RLE\_G1\_2288lm@700mA\_P=16W\_I=0.700A

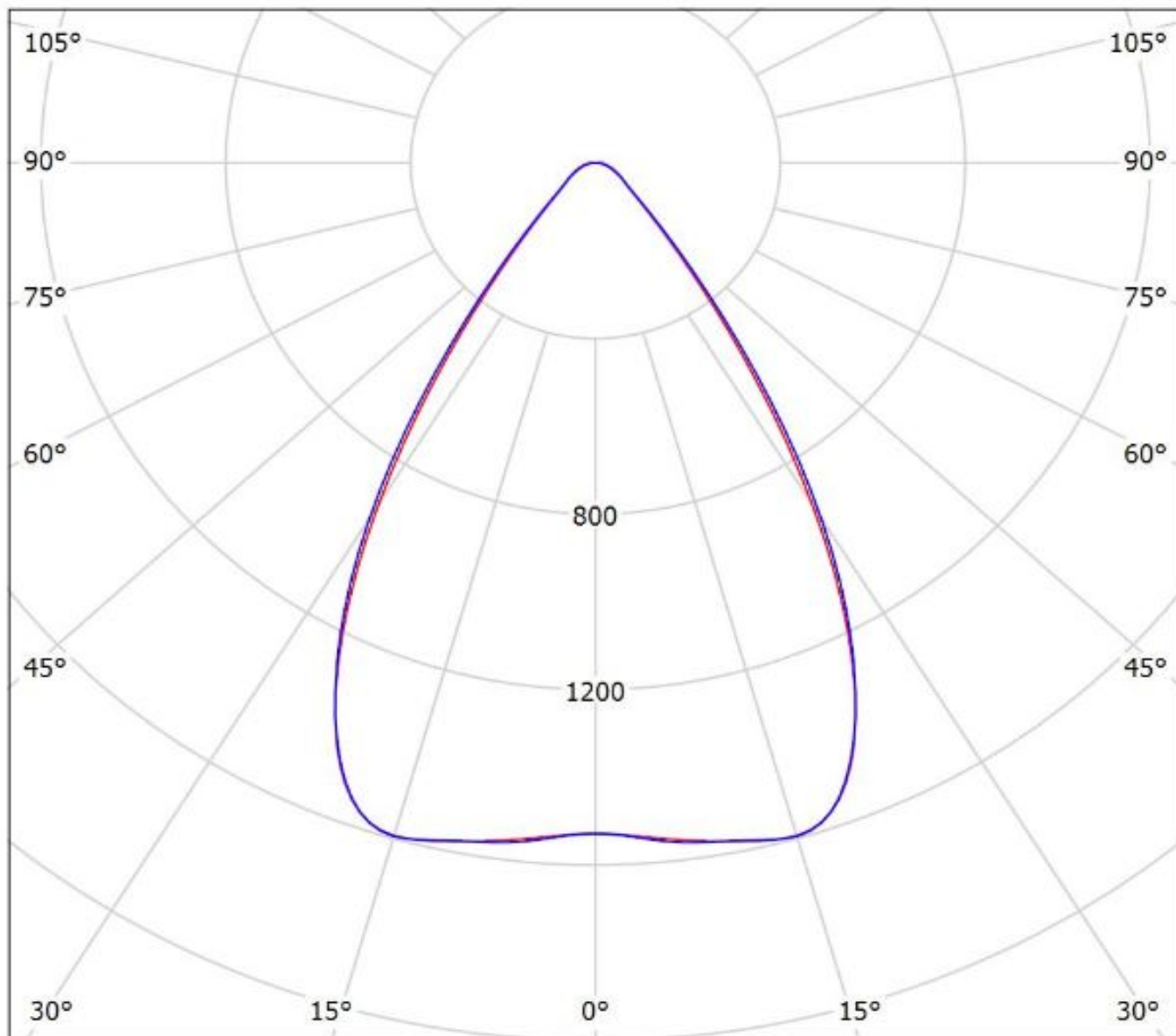

cd/klm

— C0 - C180 — C90 - C270

η = 193%

Luminaire: LEDiL Oy C13237\_HB-2X2-WW-BLIND\_(Tridonic\_Module\_RLE\_G1)  
Lamps: 2 x Tridonic\_Module\_RLE\_G1\_2288lm@700mA\_P=16W\_I=0.700A

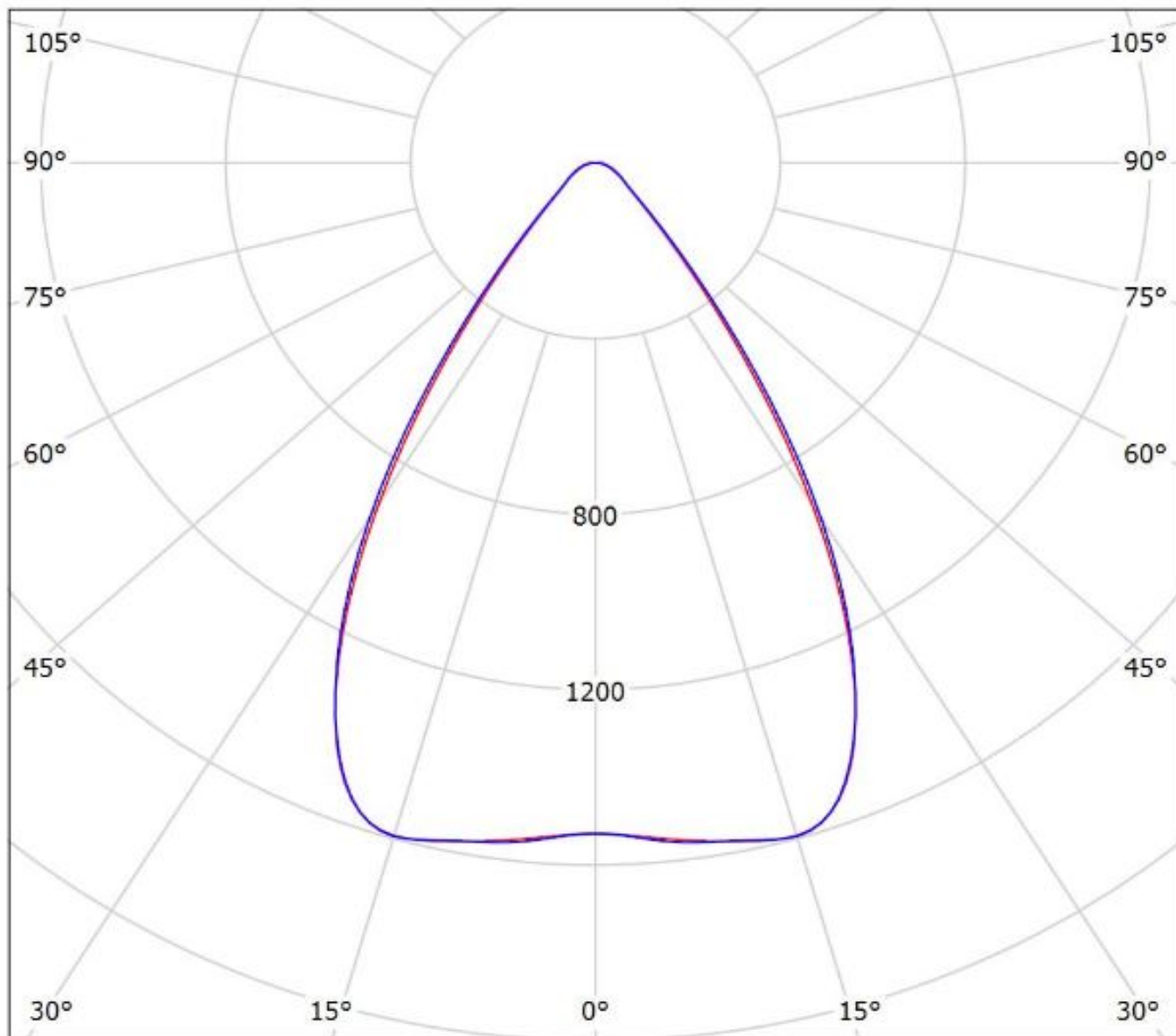

cd/klm  
— C0 - C180 — C90 - C270

η = 193%

Luminaire: LEDiL Oy C13237\_HB-2X2-WW-BLIND\_(Tridonic\_Module\_RLE\_G1)  
Lamps: 1 x Tridonic\_Module\_RLE\_G1\_4576.03lm@700mA\_P=32.0681W\_η=0.700A

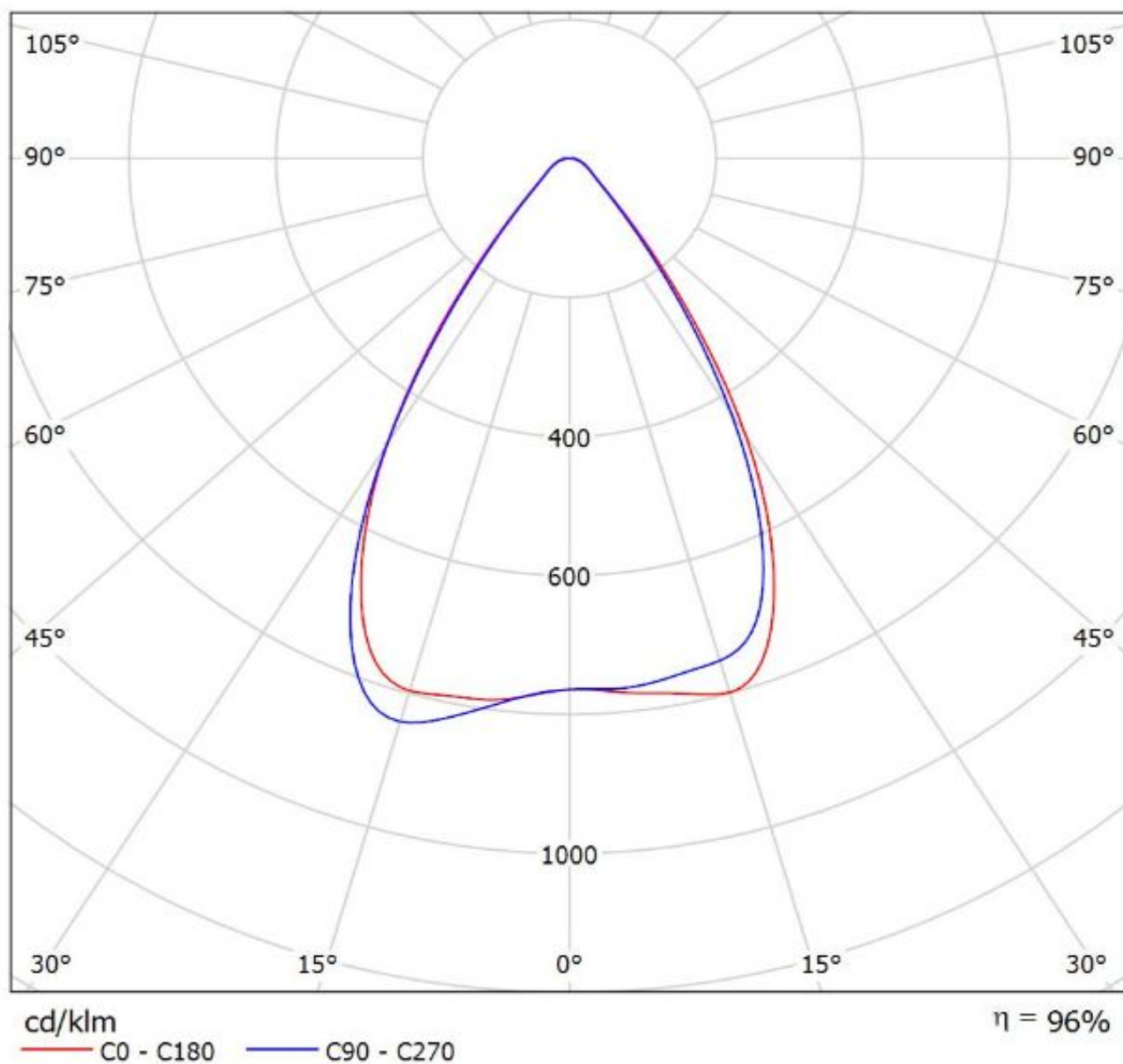



**NOTE: The typical divergence will be changed by different color, chip size and chip position tolerance. The typical total divergence is the full angle measured where the luminous intensity is half of the peak value.**