

Dual band (2.4 GHz & 5.5 GHz) WiFi/Bluetooth Chip Antenna

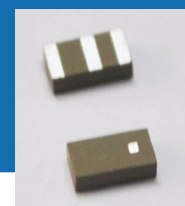

ACAG0301-24505500-T

3.2 x 1.6 x 1.2mm



RoHS/RoHS II Compliant

MSL = 1

FEATURES

- Dual band chip antenna
- Gain of 2.23dBi | 4.05dBi
- Made using LTCC (low temperature co-fired ceramic) technology
- Small form factor 3.2 x 1.6 x 1.2mm
- Omni-directional

APPLICATIONS

- IoT and wearable
- Wifi
- Bluetooth
- ISM applications

ELECTRICAL CHARACTERISTICS

Item	Specification	
Frequency Range	2400 MHz~2500 MHz	5150 MHz~5850 MHz
Frequency After Matching	2450 MHz	5500 MHz
Bandwidth	100 MHz (typ.)	800 MHz (typ.)
Return Loss	-7 dB (max.)	-7 dB (max.)
Gain	2.23 dBi	4.05 dBi
Impedance	50 Ω	
Azimuth	Omni-directional	
Operating Temperature range	-40°C ~+ 85°C	

MECHANICAL DIMENSIONS (mm)

Antenna Dimension

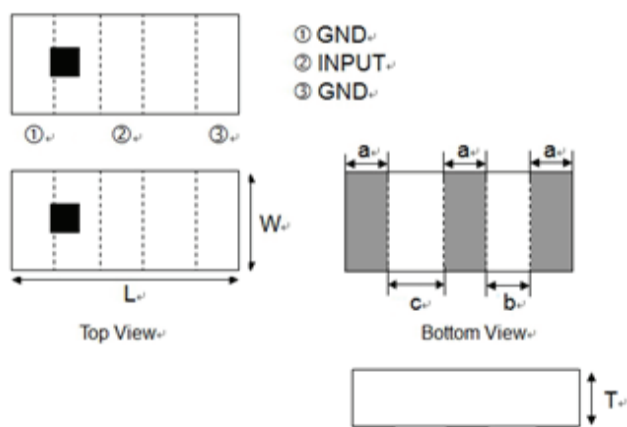

Symbol	L	W	T	a	b	c
Dimensions	3.2±0.2	1.6±0.2	1.2±0.1	0.5±0.1	0.7±0.1	1.0±0.1

Layout Dimension

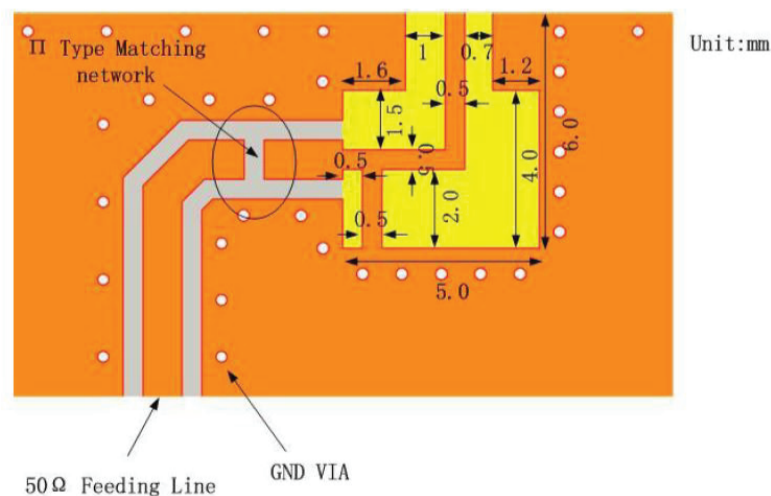

Dual band (2.4 GHz & 5.5 GHz) WiFi/Bluetooth Chip Antenna

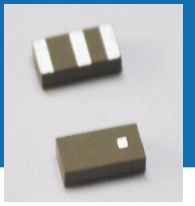

ACAG0301-24505500-T

3.2 x 1.6 x 1.2mm



RoHS/RoHS II Compliant

MSL = 1

EVALUATION BOARD AND MATCHING CIRCUITS

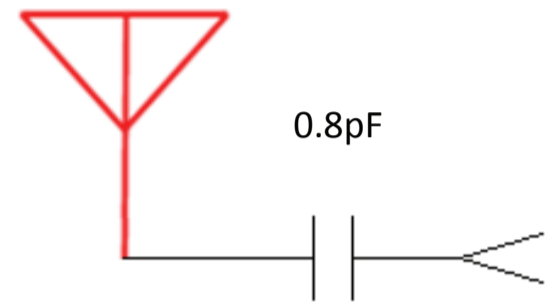
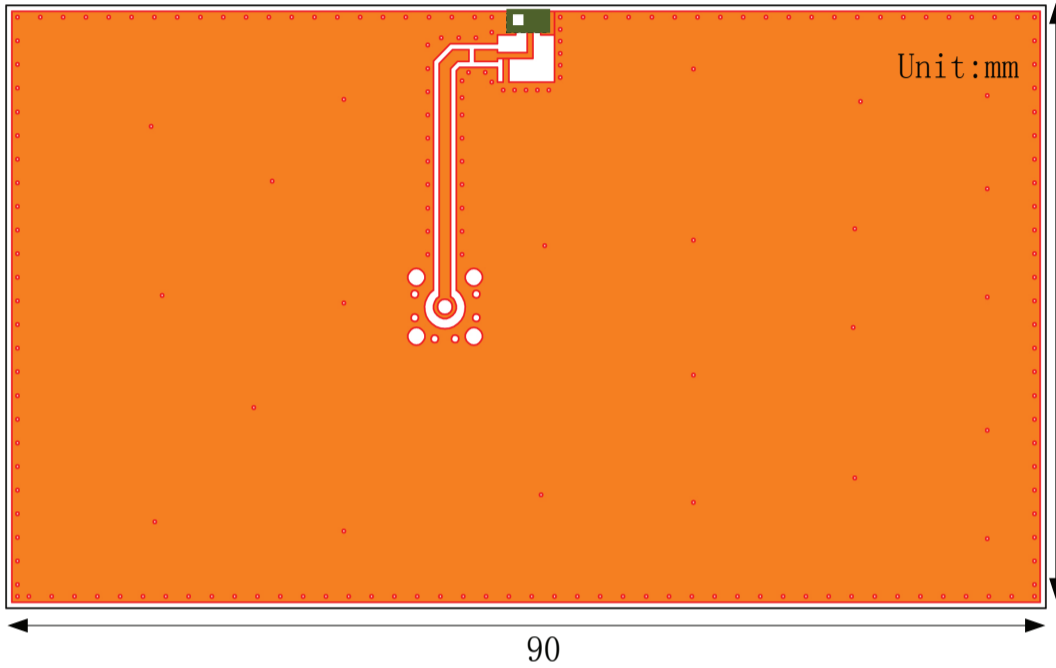

ANTENNA RESPONSE – SMITH CHART AND RETURN LOSS S11

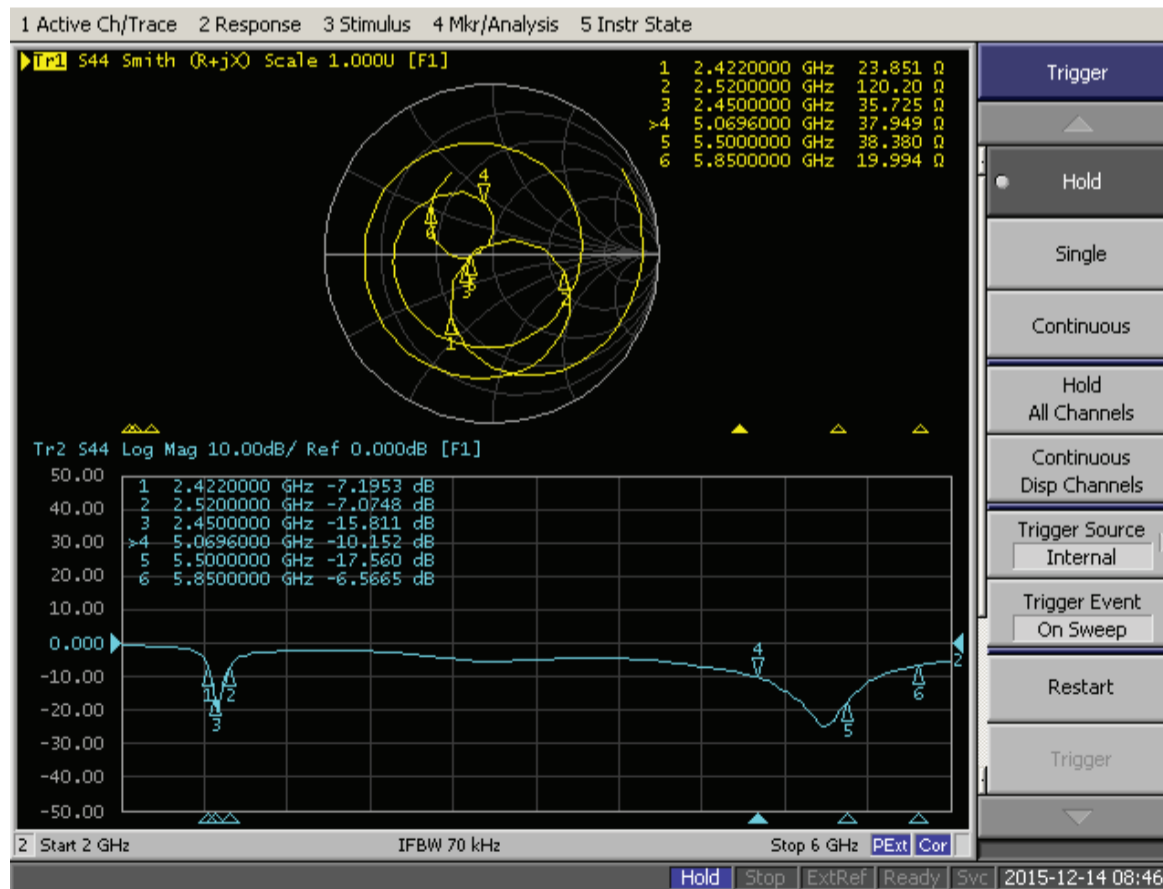

Dual band (2.4 GHz & 5.5 GHz) WiFi/Bluetooth Chip Antenna

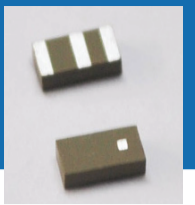

ACAG0301-24505500-T

3.2 x 1.6 x 1.2mm



RoHS/RoHS II Compliant

MSL = 1

RADIATION PATTERNS

Coordinates

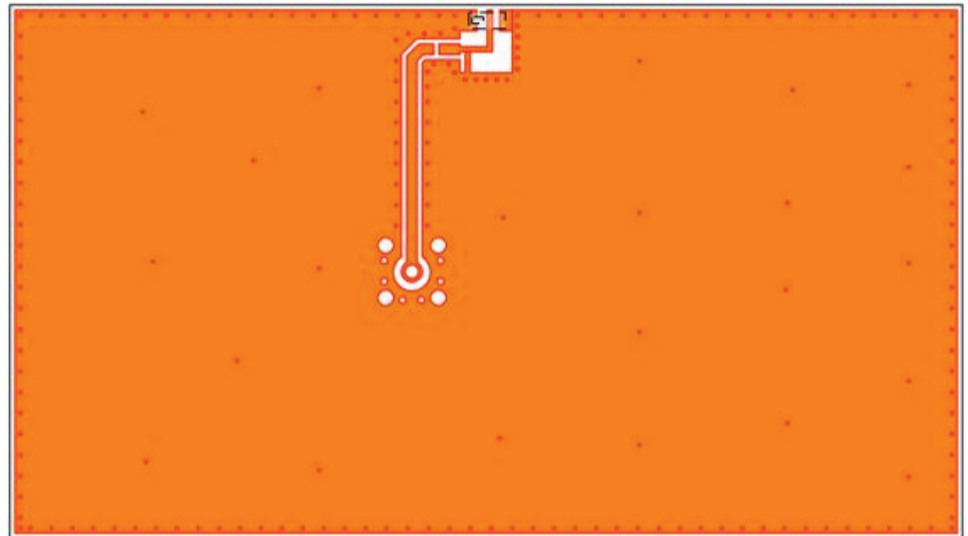
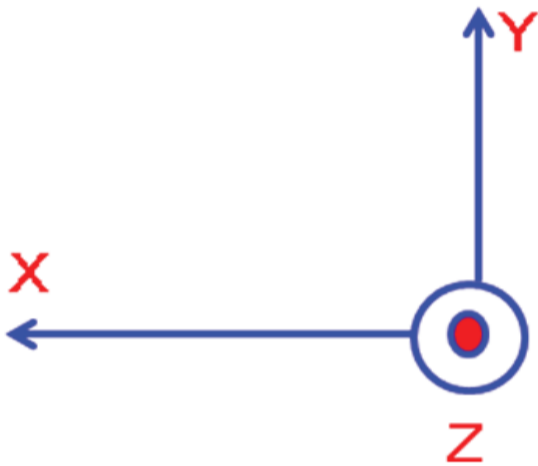

2.4 GHz X-Z Plane

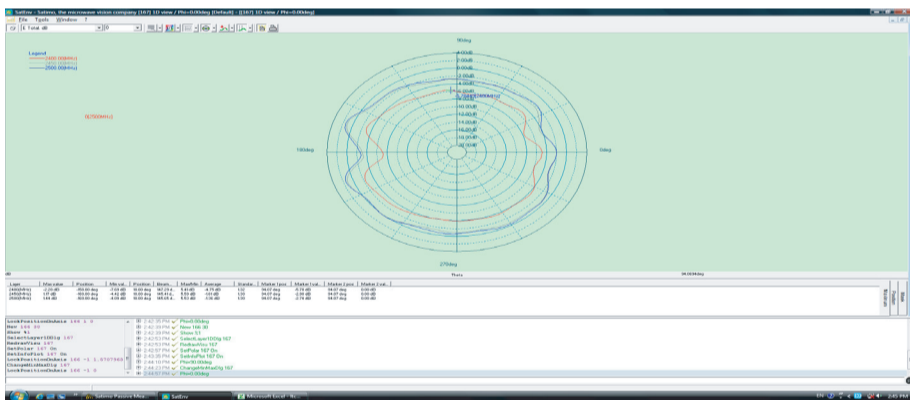

2.4 GHz Y-Z Plane

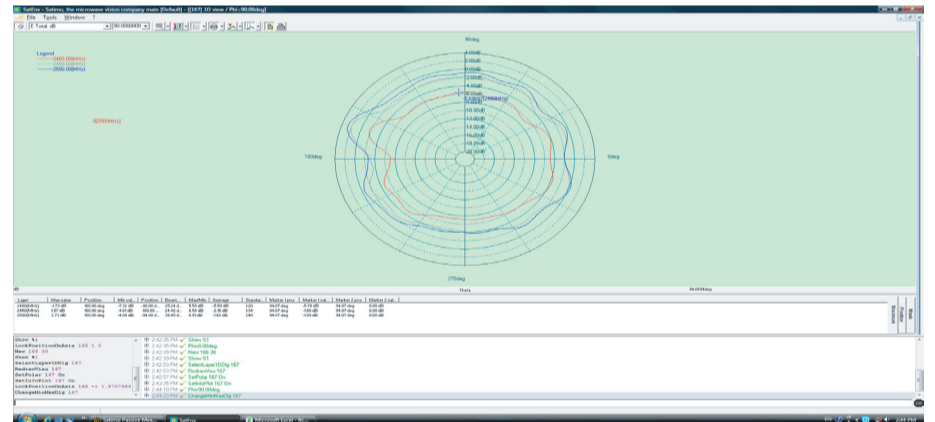

2.4 GHz X-Y Plane

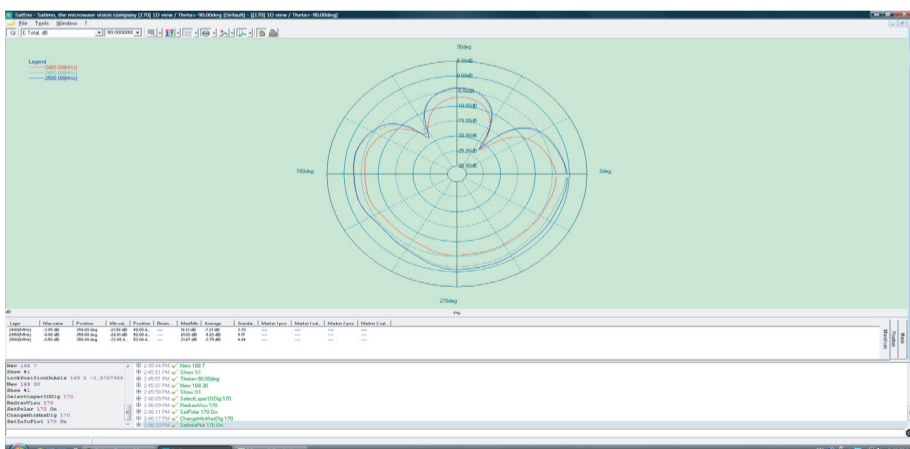

5 GHz X-Z Plane

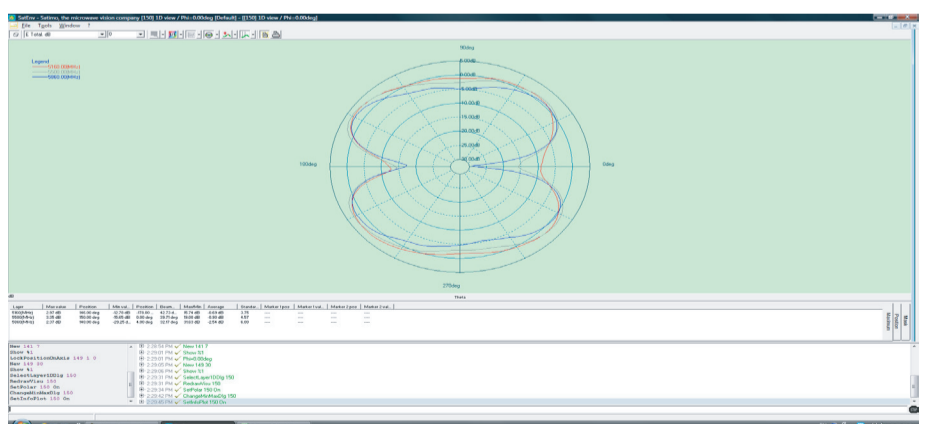

Dual band (2.4 GHz & 5.5 GHz) WiFi/Bluetooth Chip Antenna

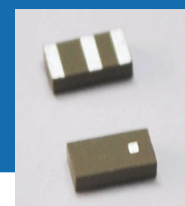

ACAG0301-24505500-T

3.2 x 1.6 x 1.2mm



RoHS/RoHS II Compliant

MSL = 1

RADIATION PATTERNS

5 GHz Y-Z Plane

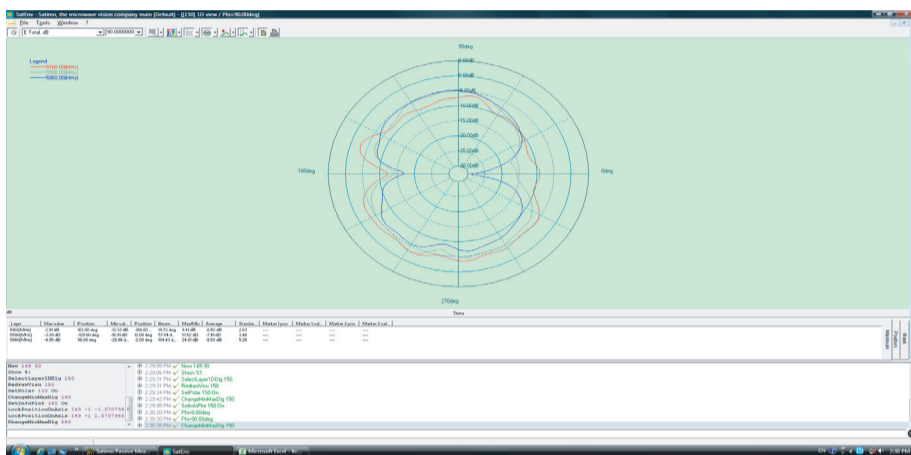

5 GHz X-Y Plane

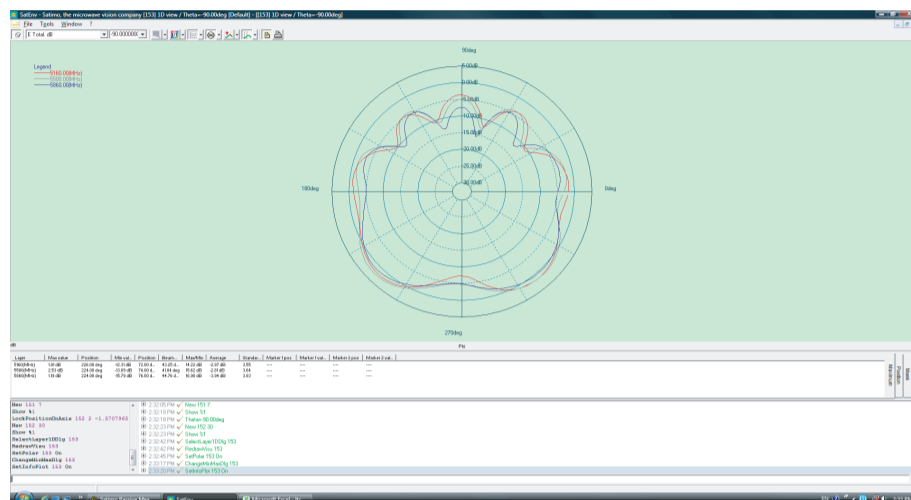

3D RADIATION PATTERNS

2450 MHz

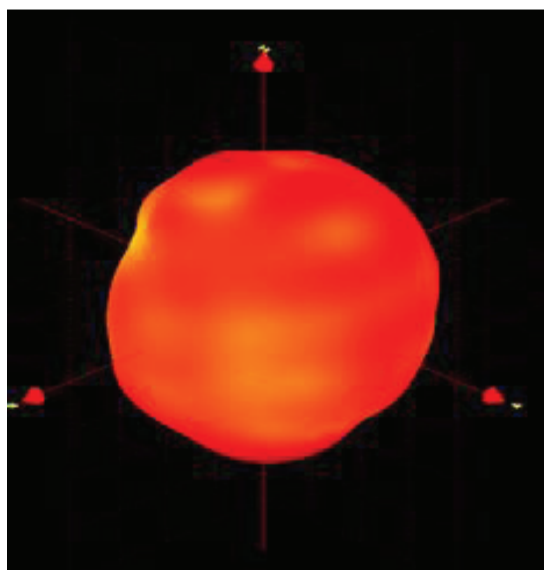

5500 MHz

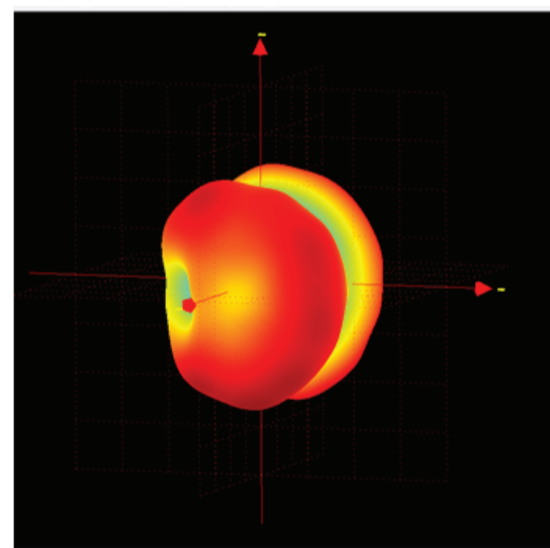

Frequency (MHz)	2400	2450	2500
Avg. Gain (dBi)	-4.75	-1.61	-1.36
Peak Gain (dBi)	1.95	2.23	2.07
Efficiency (%)	42	66.5	5

Frequency (MHz)	5150	5500	5850
Avg. Gain (dBi)	-4.75	-1.61	-1.36
Peak Gain (dBi)	3.87	4.05	3.92
Efficiency (%)	70	76.8	64

REVISED: 06.21.2018

Dual band (2.4 GHz & 5.5 GHz) WiFi/Bluetooth Chip Antenna

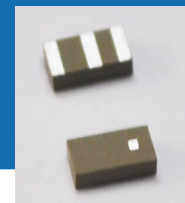

ACAG0301-24505500-T

3.2 x 1.6 x 1.2mm

 RoHS/RoHS II Compliant

MSL = 1

REFLOW SOLDERING STANDARD CONDITION

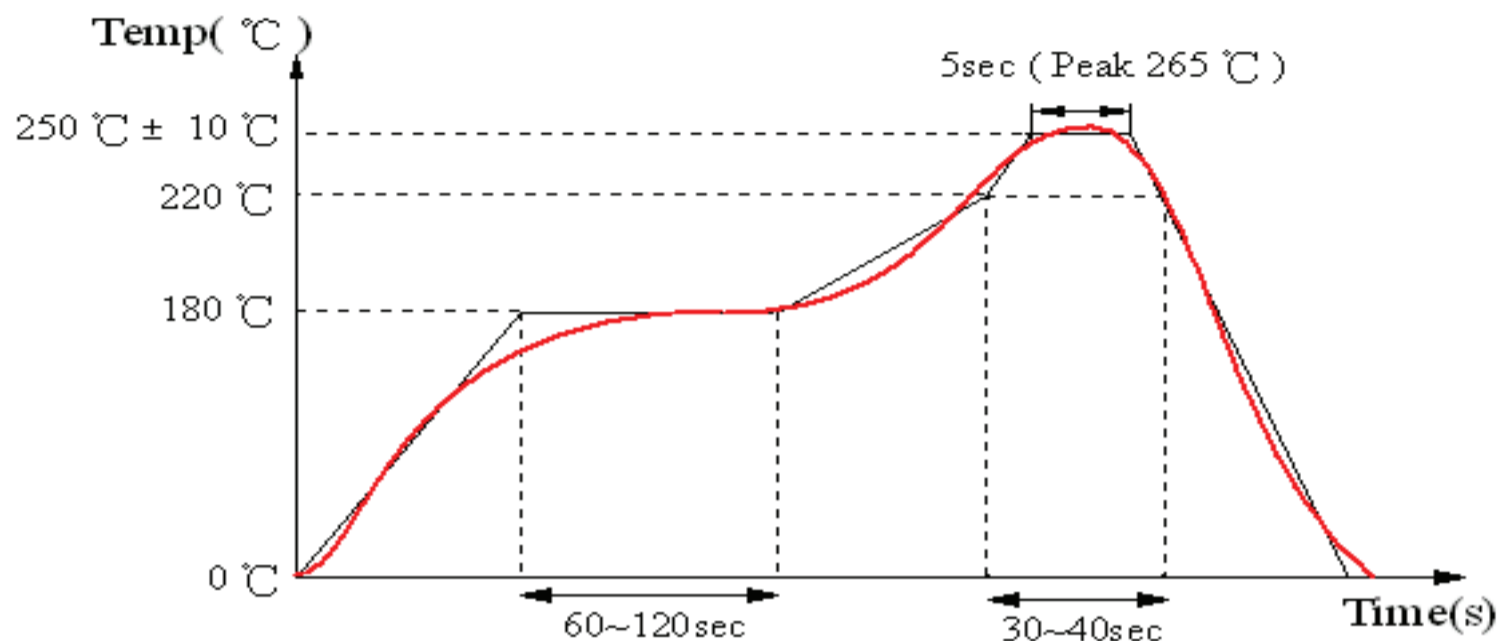

PACKAGING

Reel (3000 pcs/Reel)

Size of the carton: 330 x 210 x 210 mm

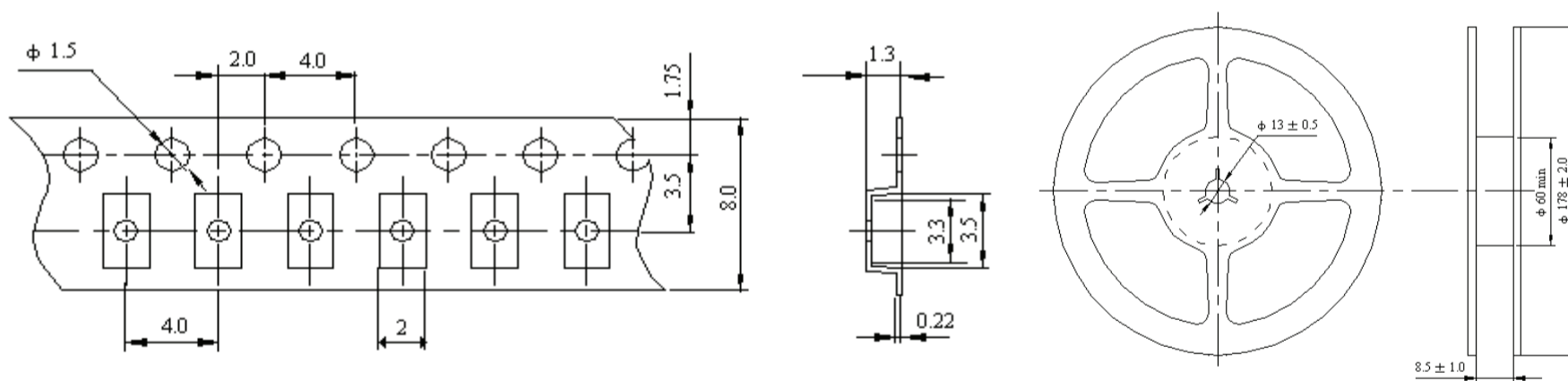

Dimensions: mm

Storage Temperature Range : <30 degree C, Humidity : <60%RH

MSL - 1

Oxidizable, 12 months in a vacuum sealed bag.

Once opened, please repack the unused items within 168 hours by re-seal package treatment.

Dual band (2.4 GHz & 5.5 GHz) WiFi/Bluetooth Chip Antenna

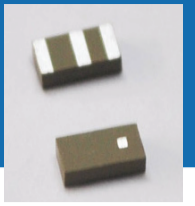

ACAG0301-24505500-T



3.2 x 1.6 x 1.2mm
RoHS/RoHS II Compliant

MSL = 1

CAUTIONS

1. Static voltage

Static voltage between signal & ground may cause deterioration & destruction of the component. Please avoid static voltage.

2. Ultrasonic cleaning

Ultrasonic vibration may cause deterioration & destruction of the component. Please avoid ultrasonic cleaning.

3. Soldering

Only leads of the component may be soldered. Please avoid soldering to any other part of the component, such as on the patterns as this will change the performance of the antenna.