

#### PROTECTION PRODUCTS - Z-Pak™

#### Description

$\mu$ Clamp<sup>®</sup> TVS diodes are designed to protect sensitive electronics from damage or latch-up due to ESD. They are designed to replace multilayer varistors (MLVs) in portable applications such as cell phones, notebook computers, and other portable electronics. They feature large cross-sectional area junctions for conducting high transient currents. These devices offers desirable characteristics for board level protection including fast response time, low operating and clamping voltage, and no device degradation.

$\mu$ Clamp<sup>®</sup>0512Z features extremely good ESD protection characteristics highlighted by low typical dynamic resistance, low peak ESD clamping voltage, and high ESD withstand voltage (+/-15kV contact per IEC 61000-4-2). Low typical capacitance (5pF at VR=0V) minimizes loading on sensitive circuits. Each device will protect two data lines operating at 5 Volts.

$\mu$ Clamp<sup>®</sup>0512Z is in a 3-pin SLP0603P3X3A package measuring 0.6 x 0.3 mm with a nominal height of only 0.25mm. The leads partially extend up the side of the package for ease of soldering and are finished with lead-free NiAu. The combination of small size and high ESD surge capability makes them ideal for use in portable applications such as cellular phones, digital cameras, and tablets.

#### Features

- ◆ High ESD withstand Voltage: +/-**15kV** (Contact), +/-**17kV** (Air) per **IEC 61000-4-2**
- ◆ Able to withstand over 1000 ESD strikes per IEC 61000-4-2 Level 4
- ◆ Ultra-small **0201 package**
- ◆ Protects two data lines
- ◆ Low reverse current: <3nA typical (VR=5V)
- ◆ Working voltage: +/- 5V
- ◆ Low capacitance: 5pF typical
- ◆ Extremely low dynamic resistance: 0.63 Ohms (Typ)
- ◆ Solid-state silicon-avalanche technology

#### Mechanical Characteristics

- ◆ SLP0603P3X3A package
- ◆ Pb-Free, Halogen Free, RoHS/WEEE Compliant
- ◆ Nominal Dimensions: 0.6 x 0.3 x 0.25 mm
- ◆ Lead Finish: NiAu
- ◆ Molding compound flammability rating: UL 94V-0
- ◆ Marking : Marking code + dot matrix date code
- ◆ Packaging : Tape and Reel

#### Applications

- ◆ Cellular Handsets & Accessories
- ◆ Keypads, Side Keys, Audio Ports
- ◆ Portable Instrumentation
- ◆ Digital Lines
- ◆ Tablet PC

#### Nominal Dimensions

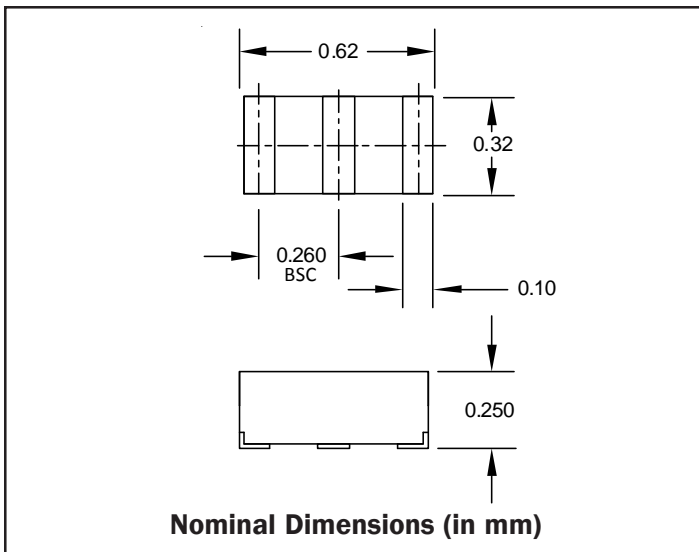

#### Schematic

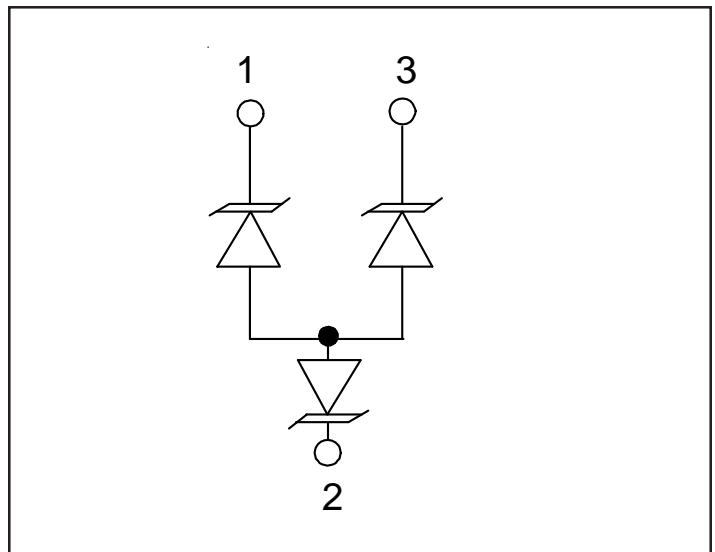

**PROTECTION PRODUCTS**
**Absolute Maximum Rating**

Rating	Symbol	Value	Units
Peak Pulse Power (tp = 8/20μs)	$P_{pk}$	30	Watts
Maximum Peak Pulse Current (tp = 8/20μs)	$I_{pp}$	2	Amps
ESD per IEC 61000-4-2 (Air) <sup>1</sup> ESD per IEC 61000-4-2 (Contact) <sup>1</sup>	$V_{ESD}$	+/- 17 +/- 15	kV
Operating Temperature	$T_J$	-40 to +125	°C
Storage Temperature	$T_{STG}$	-55 to +150	°C

**Electrical Characteristics (T=25°C)**

Parameter	Symbol	Conditions	Minimum	Typical	Maximum	Units
Reverse Stand-Off Voltage	$V_{RWM}$	Between any two pins			5	V
Reverse Breakdown Voltage	$V_{BR}$	$I_t = 1mA$ Between any two pins	6	8.2	9.5	V
Reverse Leakage Current	$I_R$	$V_{RWM} = 5V, T=25°C$ Between any two pins		3	50	nA
Clamping Voltage	$V_C$	$I_{pp} = 2A, tp = 8/20μs$ Between any two pins			15	V
ESD Clamping Voltage <sup>2</sup>	$V_C$	$IPP = 4A,$ $t_{lp} = 0.2/100ns$ Pin 1 to 2 or 3 to 2		12.5		V
ESD Clamping Voltage <sup>2</sup>	$V_C$	$IPP = 16A,$ $t_{lp} = 0.2/100ns$ Pin 1 to 2 or 3 to 2		20		V
Dynamic Resistance <sup>2, 3</sup>	$R_D$	$tp = 100ns$ Pin 1 to 2 or 3 to 2		0.63		Ohms
Junction Capacitance	$C_j$	$V_R = 0V f = 1MHz$ Between any two pins		5	7	pF

**Notes**

- 1)ESD gun return path connected to ESD ground reference plane.
- 2)Transmission Line Pulse Test (TLP) Settings:  $t_p = 100ns, t_r = 0.2ns, I_{TLP}$  and  $V_{TLP}$  averaging window:  $t_1 = 70ns$  to  $t_2 = 90ns$ .
- 3) Dynamic resistance calculated from  $I_{TLP} = 4A$  to  $I_{TLP} = 16A$

PROTECTION PRODUCTS

Typical Characteristics

Non-Repetitive Peak Pulse Power vs. Pulse Time

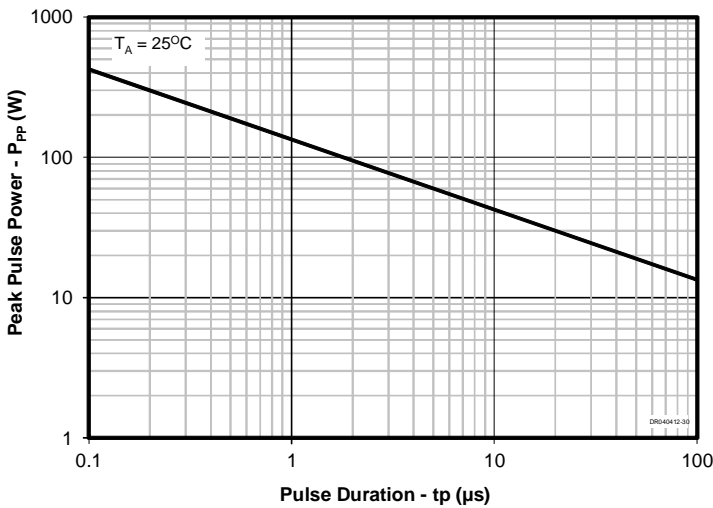

Clamping Voltage vs. Peak Pulse Current (tp=8/20us)

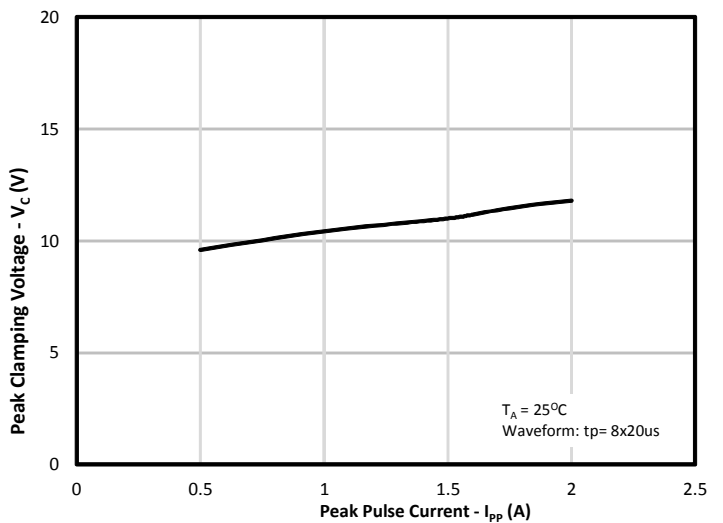

Junction Capacitance vs. Reverse Voltage

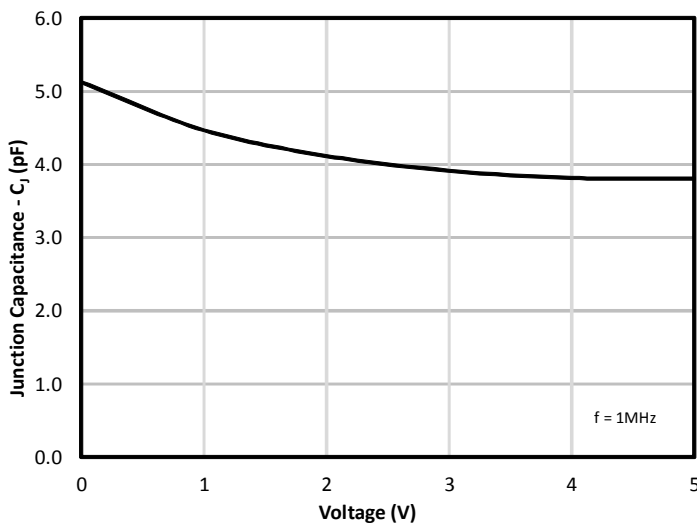

TLP Characteristic

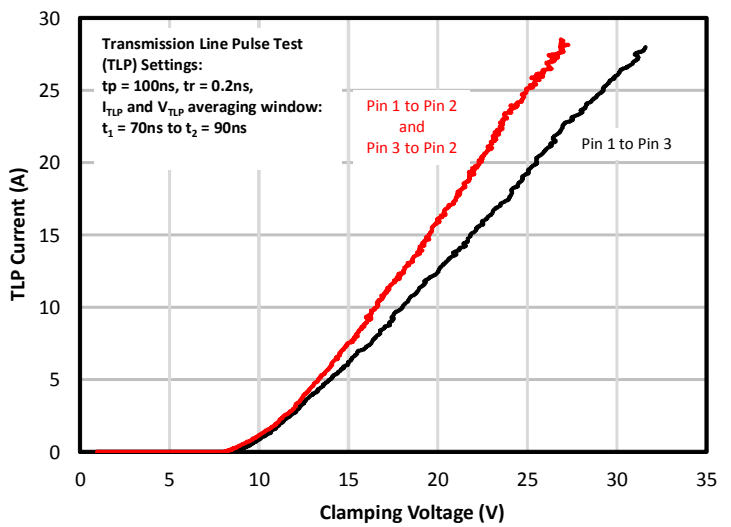

ESD Clamping (+8kV Contact per IEC 61000-4-2)

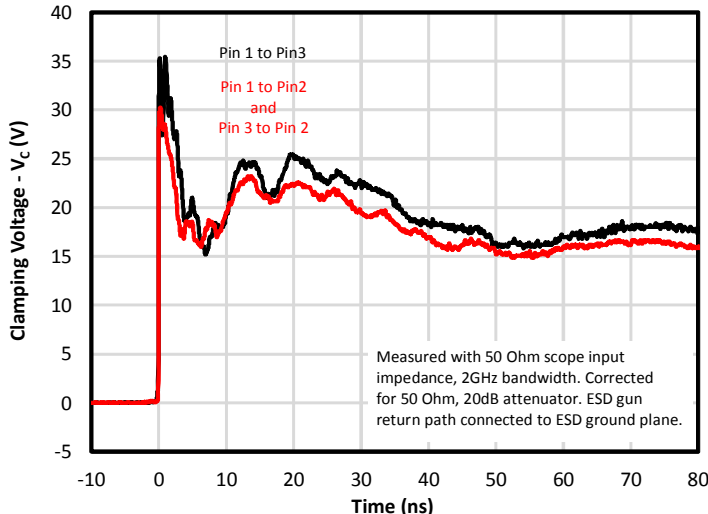

ESD Clamping (-8kV Contact per IEC 61000-4-2)

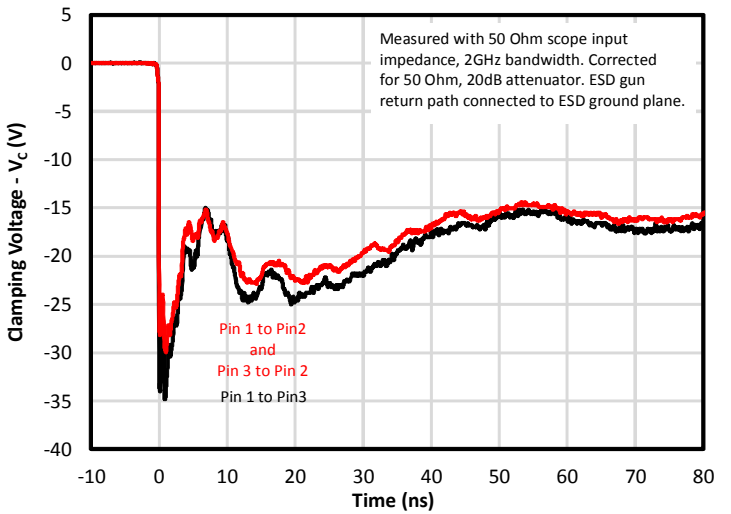

**PROTECTION PRODUCTS**

Typical Characteristics

**Typical Insertion Loss S21**

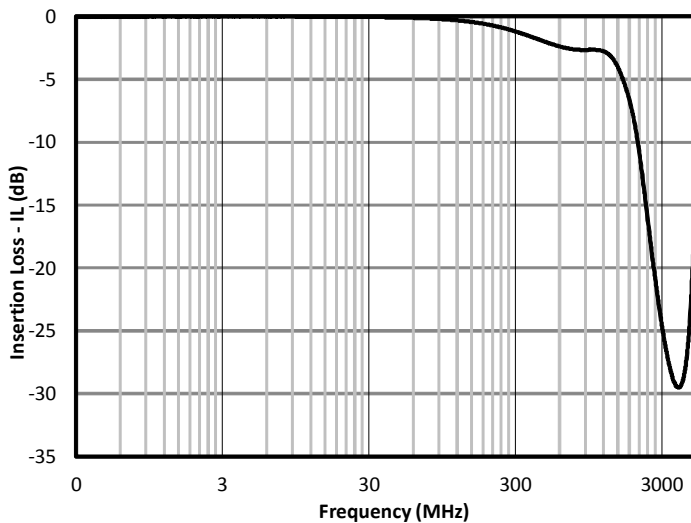

**Analog Cross Talk**

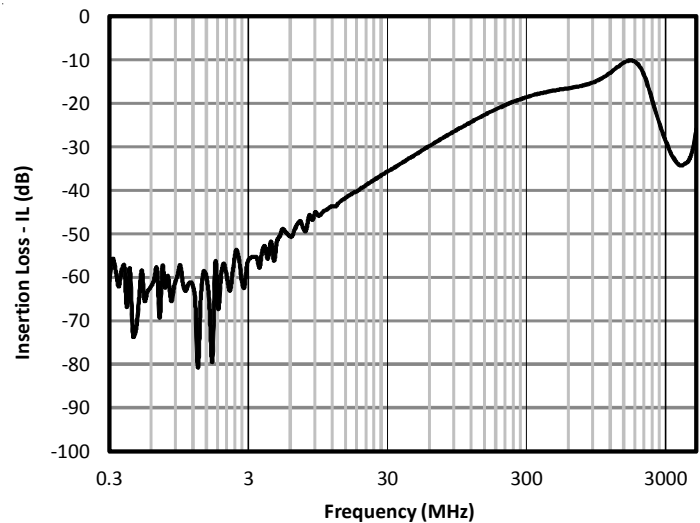





**Applications Information**

**Assembly Guidelines**

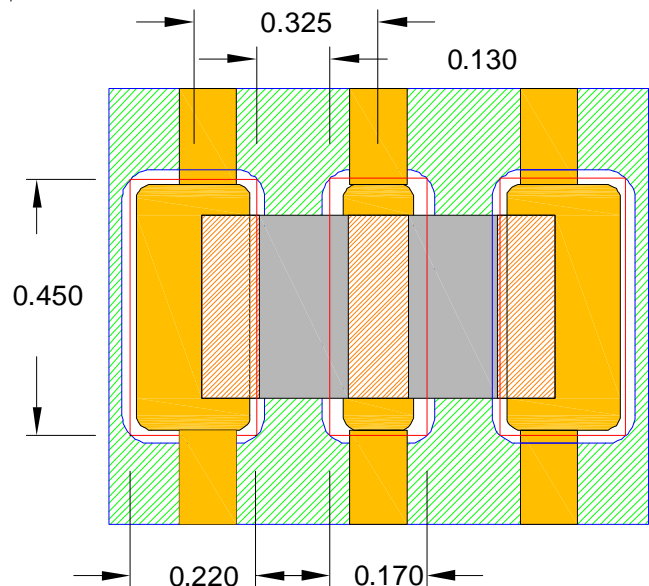
The small size of this device means that some care must be taken during the mounting process to insure reliable solder joints. The figure at the right details Semtech's recommended aperture based on the assembly guidelines detailed in the table below. Note that these are only recommendations and should serve only as a starting point for design since there are many factors that affect the assembly process. Exact manufacturing parameters will require some experimentation to get the desired solder application.

Assembly Parameter	Recommendation
Solder Stencil Design	Laser cut, Electro-polished
Aperture shape	Rectangular with rounded corners
Solder Stencil Thickness	0.100 mm (0.004")
Solder Paste Type	Type 4 size sphere or smaller
Solder Reflow Profile	Per JEDEC J-STD-020
PCB Solder Pad Design	Non-Solder mask defined
PCB Pad Finish	OSP OR NiAu



-  Stencil opening for solder print
  -  Solder Mask
  -  Land Pattern
- All Dimensions are in mm

**Recommended Mounting Pattern  
(All dimensions are in mm)**

PROTECTION PRODUCTS

Outline Drawing - SLP0603P3X3A

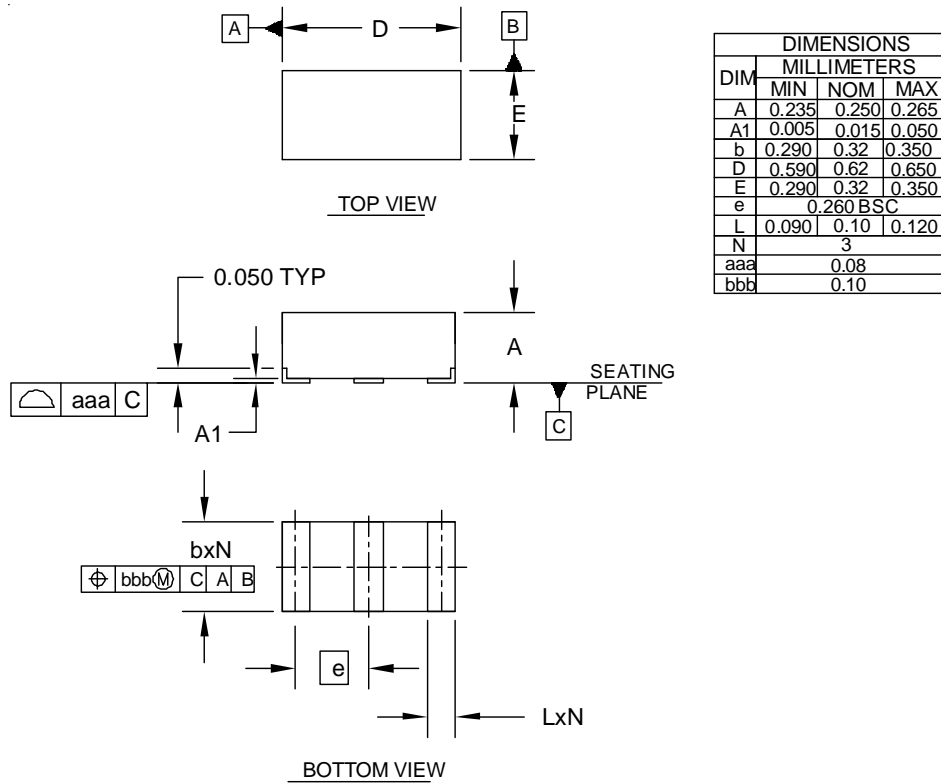

NOTES:  
1. CONTROLLING DIMENSIONS ARE IN MILLIMETERS (ANGLES IN DEGREES).

Land Pattern - SLP0603P3X3A

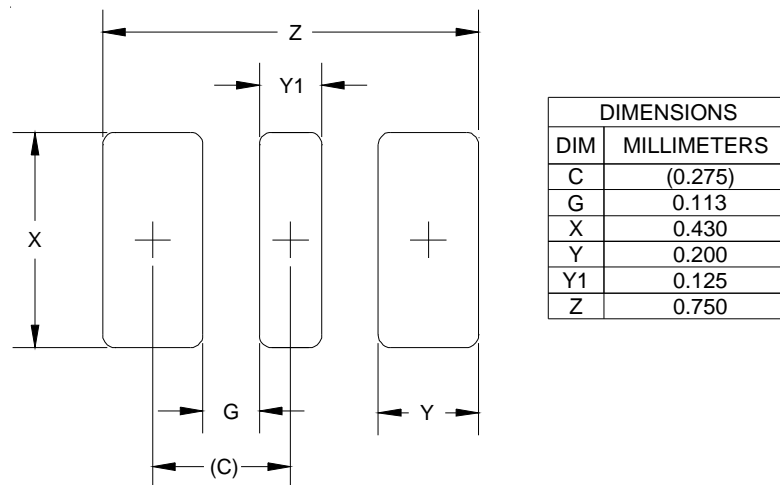

NOTES:  
1. CONTROLLING DIMENSIONS ARE IN MILLIMETERS (ANGLES IN DEGREES).  
2. THIS LAND PATTERN IS FOR REFERENCE PURPOSES ONLY. CONSULT YOUR MANUFACTURING GROUP TO ENSURE YOUR COMPANY'S MANUFACTURING GUIDELINES ARE MET.

## PROTECTION PRODUCTS

### Marking Code

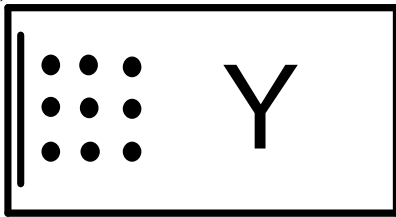

### Ordering Information

Part Number	Qty per Reel	Pocket Pitch	Reel Size
uClamp0512Z.TFT	15,000	2mm	7 Inch

Note:  
MicroClamp, uClamp and  $\mu$ Clamp are trademarks of Semtech Corporation

Note:  
Device is electrically symmetrical

### Carrier Tape Specification

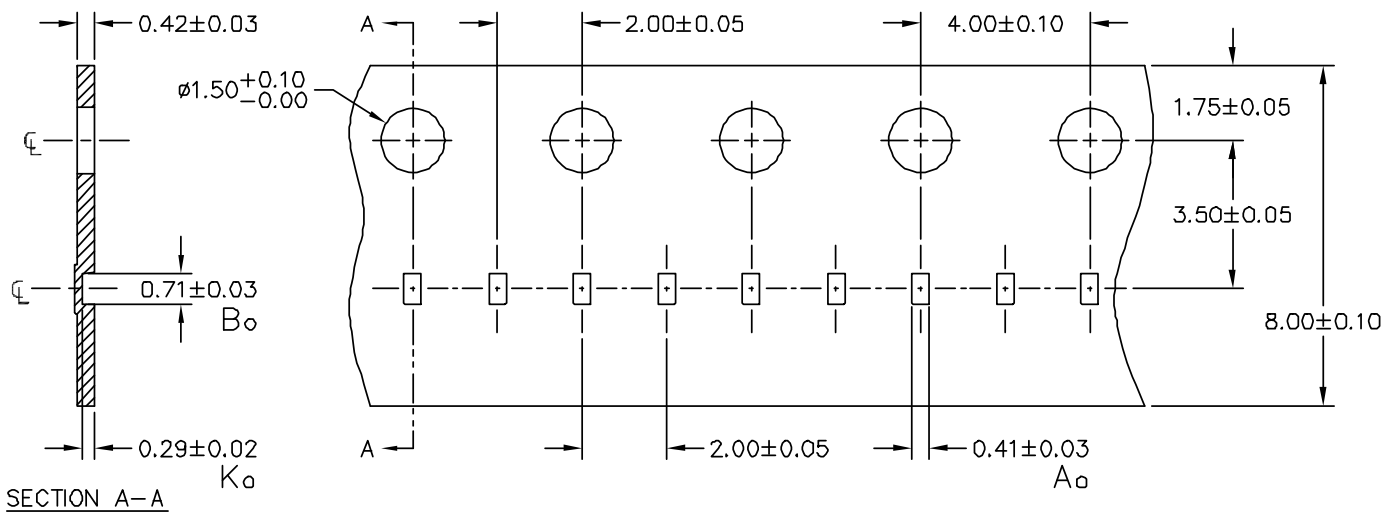

NOTES: ALL DIMENSIONS IN MILLIMETERS UNLESS OTHERWISE SPECIFIED.

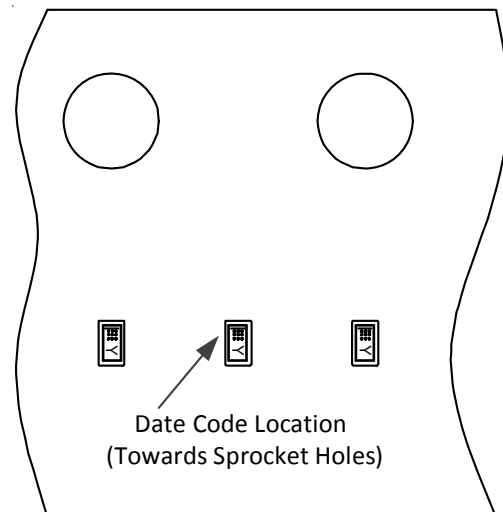

**Device Orientation in Tape**

**Contact Information**

Semtech Corporation  
Protection Products Division  
200 Flynn Rd., Camarillo, CA 93012  
Phone: (805)498-2111 FAX (805)498-3804