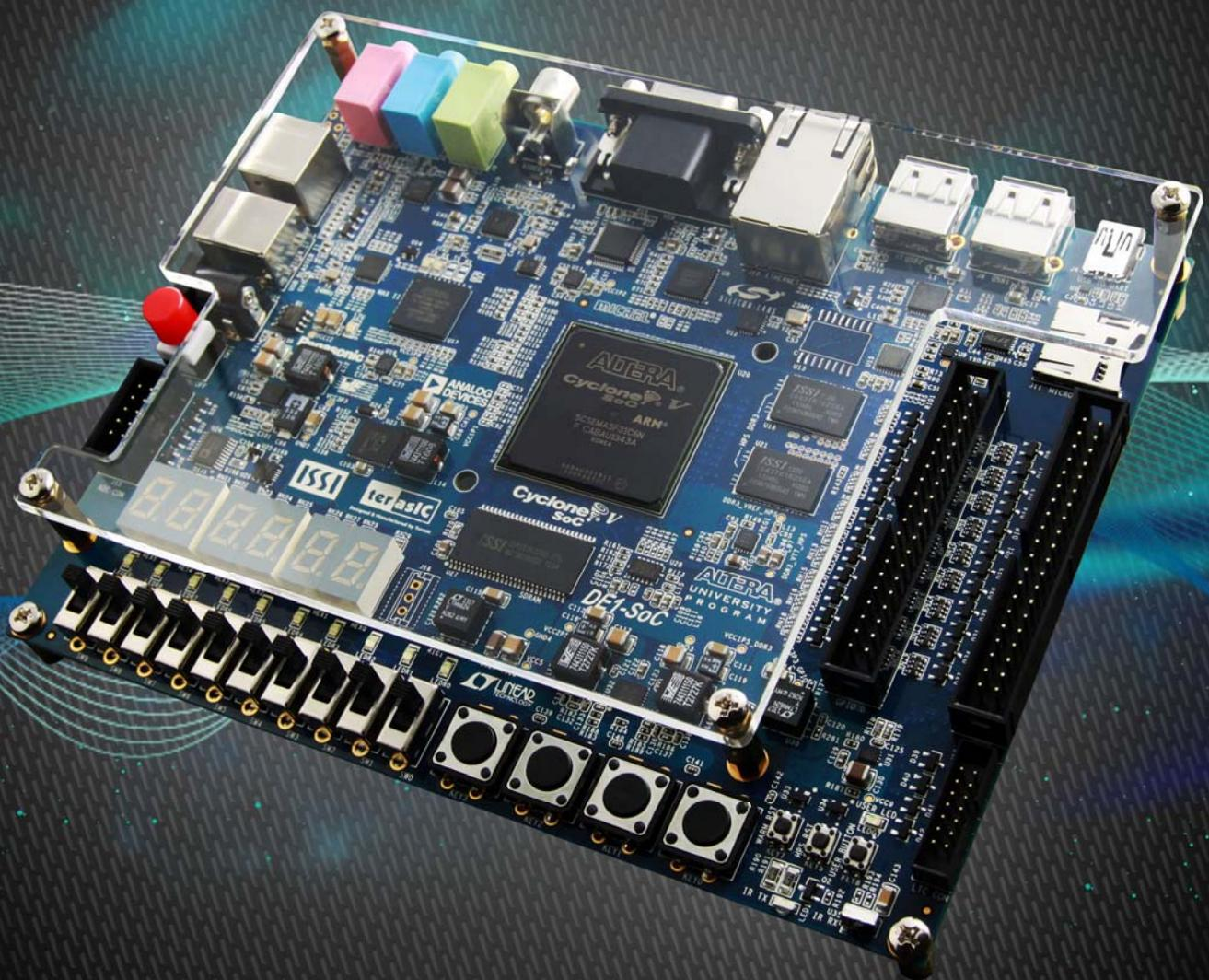


# DE1-SOC

## USER MANUAL



<b>CHAPTER 1</b>	<b><i>DE1-SOC DEVELOPMENT KIT</i></b> .....	<b>4</b>
1.1	Package Contents .....	4
1.2	DE1-SoC System CD .....	5
1.3	Getting Help .....	5
<b>CHAPTER 2</b>	<b><i>INTRODUCTION OF THE DE1-SOC BOARD</i></b> .....	<b>6</b>
2.1	Layout and Components.....	6
2.2	Block Diagram of the DE1-SoC Board.....	8
<b>CHAPTER 3</b>	<b><i>USING THE DE1-SOC BOARD</i></b> .....	<b>12</b>
3.1	Settings of FPGA Configuration Mode .....	12
3.2	Configuration of Cyclone V SoC FPGA on DE1-SoC.....	13
3.3	Board Status Elements .....	19
3.4	Board Reset Elements .....	20
3.5	Clock Circuitry .....	21
3.6	Peripherals Connected to the FPGA.....	23
3.6.1	User Push-buttons, Switches and LEDs .....	23
3.6.2	7-segment Displays .....	26
3.6.3	2x20 GPIO Expansion Headers.....	28
3.6.4	24-bit Audio CODEC .....	30
3.6.5	I2C Multiplexer .....	31
3.6.6	VGA .....	32
3.6.7	TV Decoder .....	35
3.6.8	IR Receiver.....	37
3.6.9	IR Emitter LED .....	37

3.6.10 SDRAM Memory .....	38
3.6.11 PS/2 Serial Port .....	40
3.6.12 A/D Converter and 2x5 Header .....	42
3.7 Peripherals Connected to Hard Processor System (HPS).....	43
3.7.1 User Push-buttons and LEDs .....	43
3.7.2 Gigabit Ethernet .....	44
3.7.3 UART .....	45
3.7.4 DDR3 Memory.....	46
3.7.5 Micro SD Card Socket .....	48
3.7.6 2-port USB Host.....	49
3.7.7 G-sensor .....	50
3.7.8 LTC Connector.....	51
<b>CHAPTER 4 DE1-SOC SYSTEM BUILDER.....</b>	<b>53</b>
4.1 Introduction .....	53
4.2 Design Flow .....	53
4.3 Using DE1-SoC System Builder .....	54
<b>CHAPTER 5 EXAMPLES FOR FPGA.....</b>	<b>60</b>
5.1 DE1-SoC Factory Configuration.....	60
5.2 Audio Recording and Playing .....	61
5.3 Karaoke Machine .....	64
5.4 SDRAM Test in Nios II.....	66
5.5 SDRAM Test in Verilog .....	69
5.6 TV Box Demonstration .....	71
5.7 PS/2 Mouse Demonstration.....	73
5.8 IR Emitter LED and Receiver Demonstration .....	76
5.9 ADC Reading .....	82
<b>CHAPTER 6 EXAMPLES FOR HPS SOC .....</b>	<b>85</b>

6.1 Hello Program .....	85
6.2 Users LED and KEY .....	87
6.3 I2C Interfaced G-sensor .....	93
6.4 I2C MUX Test.....	96
<b>CHAPTER 7   <i>EXAMPLES FOR USING BOTH HPS SOC AND FGPA</i></b> .....	<b>99</b>
7.1 HPS Control LED and HEX.....	99
7.2 DE1-SoC Control Panel .....	103
7.3 DE1-SoC Linux Frame Buffer Project.....	103
<b>CHAPTER 8   <i>PROGRAMMING THE EPCQ DEVICE</i></b> .....	<b>105</b>
8.1 Before Programming Begins .....	105
8.2 Convert .SOF File to .JIC File.....	105
8.3 Write JIC File into the EPCQ Device.....	110
8.4 Erase the EPCQ Device.....	111
8.5 Nios II Boot from EPCQ Device in Quartus II v13.1 .....	112
<b>CHAPTER 9   <i>APPENDIX</i></b> .....	<b>113</b>
9.1 Revision History.....	113
9.2 Copyright Statement.....	113

## Chapter 1

# DE1-SoC

# Development Kit

The DE1-SoC Development Kit presents a robust hardware design platform built around the Altera System-on-Chip (SoC) FPGA, which combines the latest dual-core Cortex-A9 embedded cores with industry-leading programmable logic for ultimate design flexibility. Users can now leverage the power of tremendous re-configurability paired with a high-performance, low-power processor system. Altera's SoC integrates an ARM-based hard processor system (HPS) consisting of processor, peripherals and memory interfaces tied seamlessly with the FPGA fabric using a high-bandwidth interconnect backbone. The DE1-SoC development board is equipped with high-speed DDR3 memory, video and audio capabilities, Ethernet networking, and much more that promise many exciting applications.

The DE1-SoC Development Kit contains all the tools needed to use the board in conjunction with a computer that runs the Microsoft Windows XP or later.

## 1.1 Package Contents

Figure 1-1 shows a photograph of the DE1-SoC package.



Figure 1-1 The DE1-SoC package contents

The DE1-SoC package includes:

- The DE1-SoC development board
- DE1-SoC Quick Start Guide
- USB cable (Type A to B) for FPGA programming and control
- USB cable (Type A to Mini-B) for UART control
- 12V DC power adapter

## 1.2 DE1-SoC System CD

The DE1-SoC System CD contains all the documents and supporting materials associated with DE1-SoC, including the user manual, system builder, reference designs, and device datasheets. Users can download this system CD from the link: <http://cd-de1-soc.terasic.com>.

## 1.3 Getting Help

Here are the addresses where you can get help if you encounter any problems:

- Altera Corporation
- 101 Innovation Drive San Jose, California, 95134 USA

Email: [university@altera.com](mailto:university@altera.com)

- Terasic Technologies
- 9F., No.176, Sec.2, Gongdao 5th Rd, East Dist, Hsinchu City, 30070. Taiwan

Email: [support@terasic.com](mailto:support@terasic.com)

Tel.: +886-3-575-0880

Website: [de1-soc.terasic.com](http://de1-soc.terasic.com)

## Chapter 2

# *Introduction of the DE1-SoC Board*

---

This chapter provides an introduction to the features and design characteristics of the board.

### 2.1 Layout and Components

**Figure 2-1** shows a photograph of the board. It depicts the layout of the board and indicates the location of the connectors and key components.

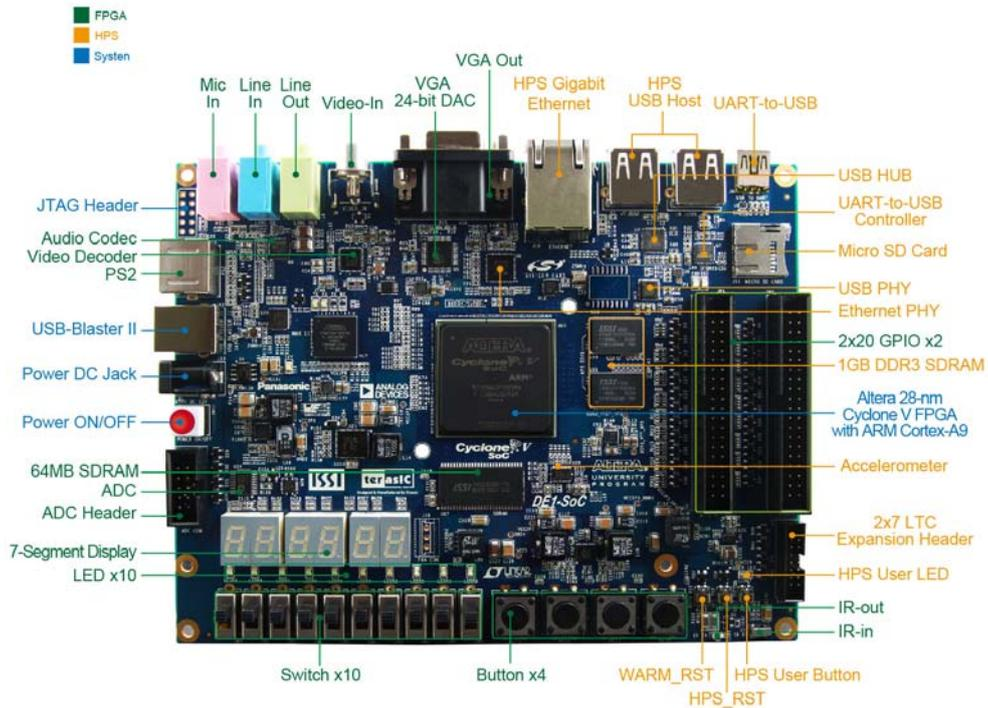


Figure 2-1 DE1-SoC development board (top view)

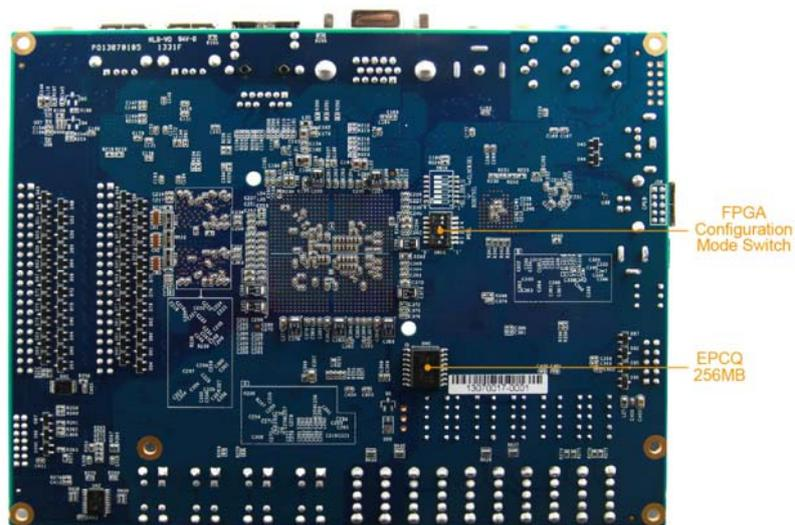


Figure 2-2 De1-SoC development board (bottom view)

The DE1-SoC board has many features that allow users to implement a wide range of designed circuits, from simple circuits to various multimedia projects.



The following hardware is provided on the board:

## ■ FPGA

- Altera Cyclone® V SE 5CSEMA5F31C6N device
- Altera serial configuration device – EPCQ256
- USB-Blaster II onboard for programming; JTAG Mode
- 64MB SDRAM (16-bit data bus)
- 4 push-buttons
- 10 slide switches
- 10 red user LEDs
- Six 7-segment displays
- Four 50MHz clock sources from the clock generator
- 24-bit CD-quality audio CODEC with line-in, line-out, and microphone-in jacks
- VGA DAC (8-bit high-speed triple DACs) with VGA-out connector
- TV decoder (NTSC/PAL/SECAM) and TV-in connector
- PS/2 mouse/keyboard connector
- IR receiver and IR emitter
- Two 40-pin expansion header with diode protection
- A/D converter, 4-pin SPI interface with FPGA

## ■ HPS (Hard Processor System)

- 800MHz Dual-core ARM Cortex-A9 MPCore processor
- 1GB DDR3 SDRAM (32-bit data bus)
- 1 Gigabit Ethernet PHY with RJ45 connector
- 2-port USB Host, normal Type-A USB connector
- Micro SD card socket
- Accelerometer (I2C interface + interrupt)
- UART to USB, USB Mini-B connector
- Warm reset button and cold reset button
- One user button and one user LED
- LTC 2x7 expansion header

## 2.2 Block Diagram of the DE1-SoC Board

**Figure 2-3** is the block diagram of the board. All the connections are established through the Cyclone V SoC FPGA device to provide maximum flexibility for users. Users can configure the FPGA to implement any system design.

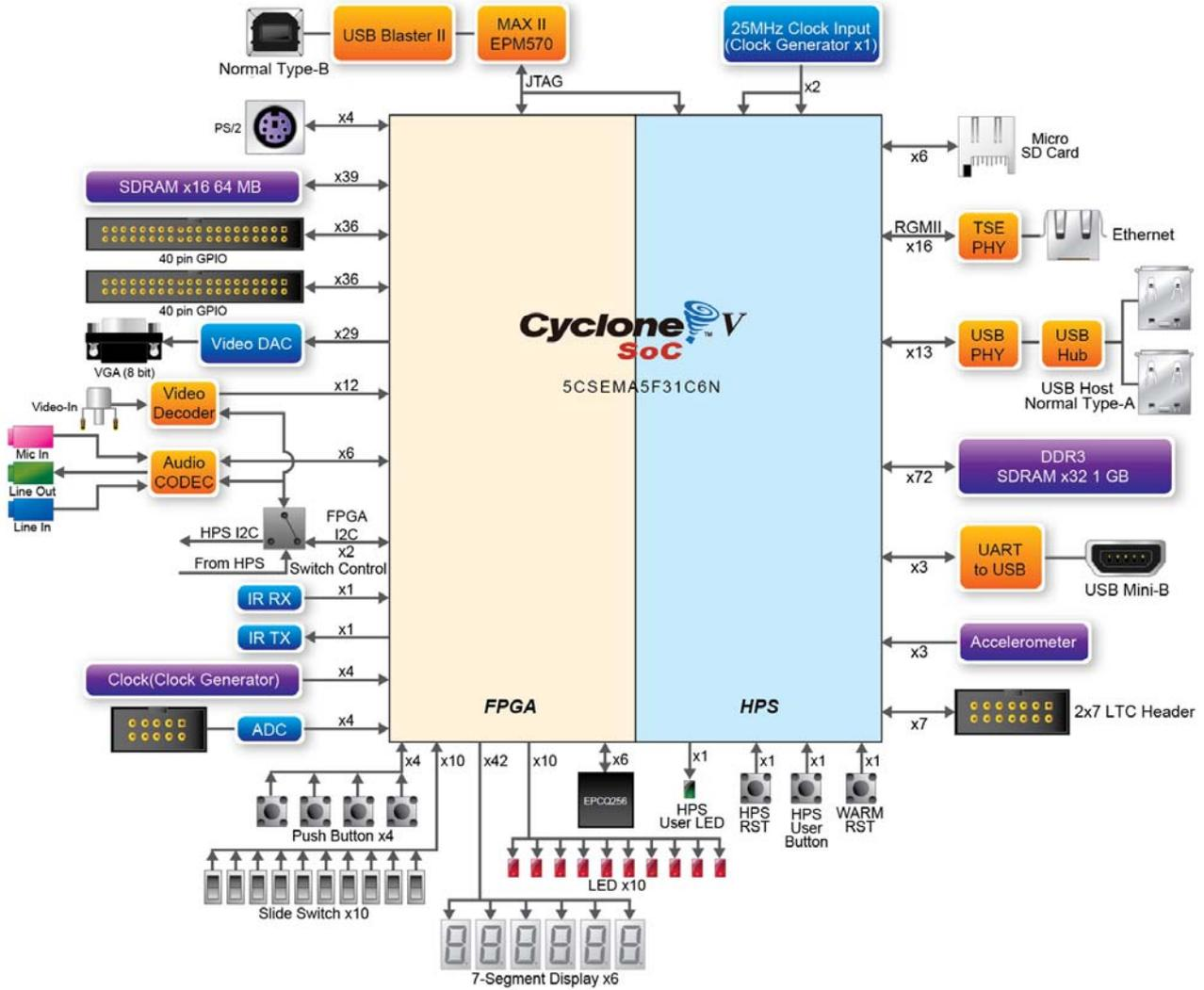


Figure 2-3 Block diagram of DE1-SoC

Detailed information about Figure 2-3 are listed below.

## FPGA Device

- Cyclone V SoC 5CSEMA5F31 Device
- Dual-core ARM Cortex-A9 (HPS)
- 85K programmable logic elements
- 4,450 Kbits embedded memory
- 6 fractional PLLs
- 2 hard memory controllers

## Configuration and Debug

- Quad serial configuration device – EPCQ256 on FPGA
- Onboard USB-Blaster II (normal type B USB connector)

## Memory Device

- 64MB (32Mx16) SDRAM on FPGA
- 1GB (2x256Mx16) DDR3 SDRAM on HPS
- Micro SD card socket on HPS

## Communication

- Two port USB 2.0 Host (ULPI interface with USB type A connector)
- UART to USB (USB Mini-B connector)
- 10/100/1000 Ethernet
- PS/2 mouse/keyboard
- IR emitter/receiver
- I2C multiplexer

## Connectors

- Two 40-pin expansion headers
- One 10-pin ADC input header
- One LTC connector (one Serial Peripheral Interface (SPI) Master ,one I2C and one GPIO interface )

## Display

- 24-bit VGA DAC

## Audio

- 24-bit CODEC, Line-in, Line-out, and microphone-in jacks

## Video Input

- TV decoder (NTSC/PAL/SECAM) and TV-in connector

## ADC

- Fast throughput rate: 1 MSPS
- Channel number: 8
- Resolution: 12-bit
- Analog input range : 0 ~ 2.5 V or 0 ~ 5V as selected via the RANGE bit in the control register

## Switches, Buttons, and Indicators

- 5 user Keys (FPGA x4, HPS x1)
- 10 user switches (FPGA x10)
- 11 user LEDs (FPGA x10, HPS x 1)
- 2 HPS reset buttons (HPS\_RESET\_n and HPS\_WARM\_RST\_n)
- Six 7-segment displays

## Sensors

- G-Sensor on HPS

## Power

- 12V DC input

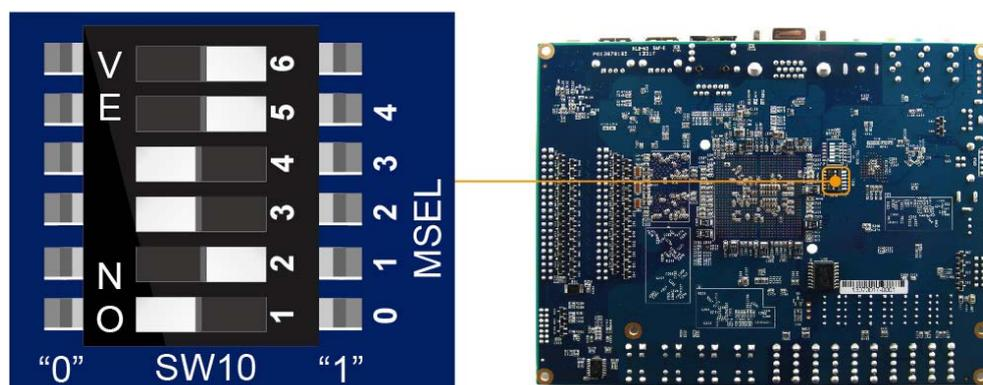
## Chapter 3

# Using the DE1-SoC Board

This chapter provides an instruction to use the board and describes the peripherals.

### 3.1 Settings of FPGA Configuration Mode

When the DE1-SoC board is powered on, the FPGA can be configured from EPCQ or HPS. The MSEL[4:0] pins are used to select the configuration scheme. It is implemented as a 6-pin DIP switch **SW10** on the DE1-SoC board, as shown in **Figure 3-1**.



**Figure 3-1** DIP switch (SW10) setting of Active Serial (AS) mode at the back of DE1-SoC board

**Table 3-1** shows the relation between MSEL[4:0] and DIP switch (SW10).

**Table 3-1 FPGA Configuration Mode Switch (SW10)**

<i>Board Reference</i>	<i>Signal Name</i>	<i>Description</i>	<i>Default</i>
SW10.1	MSEL0	Use these pins to set the FPGA Configuration scheme	ON ("0")
SW10.2	MSEL1		OFF ("1")
SW10.3	MSEL2		ON ("0")
SW10.4	MSEL3		ON ("0")
SW10.5	MSEL4		OFF ("1")
SW10.6	N/A	N/A	N/A

**Figure 3-1** shows MSEL[4:0] setting of AS mode, which is also the default setting on DE1-SoC. When the board is powered on, the FPGA is configured from EPCQ, which is pre-programmed with the default code. If developers wish to reconfigure FPGA from an application software running on Linux, the MSEL[4:0] needs to be set to "01010" before the programming process begins. If developers using the "Linux Console with frame buffer" or "Linux LXDE Desktop" SD Card image, the MSEL[4:0] needs to be set to "00000" before the board is powered on.

**Table 3-2 MSEL Pin Settings for FPGA Configure of DE1-SoC**

<i>MSEL[4:0]</i>	<i>Configure Scheme</i>	<i>Description</i>
10010	AS	FPGA configured from EPCQ (default)
01010	FPPx32	FPGA configured from HPS software: Linux
00000	FPPx16	FPGA configured from HPS software: U-Boot, with image stored on the SD card, like LXDE Desktop or console Linux with frame buffer edition.

## 3.2 Configuration of Cyclone V SoC FPGA on DE1-SoC

There are two types of programming method supported by DE1-SoC:

1. JTAG programming: It is named after the IEEE standards Joint Test Action Group.

The configuration bit stream is downloaded directly into the Cyclone V SoC FPGA. The FPGA will retain its current status as long as the power keeps applying to the board; the configuration information will be lost when the power is off.

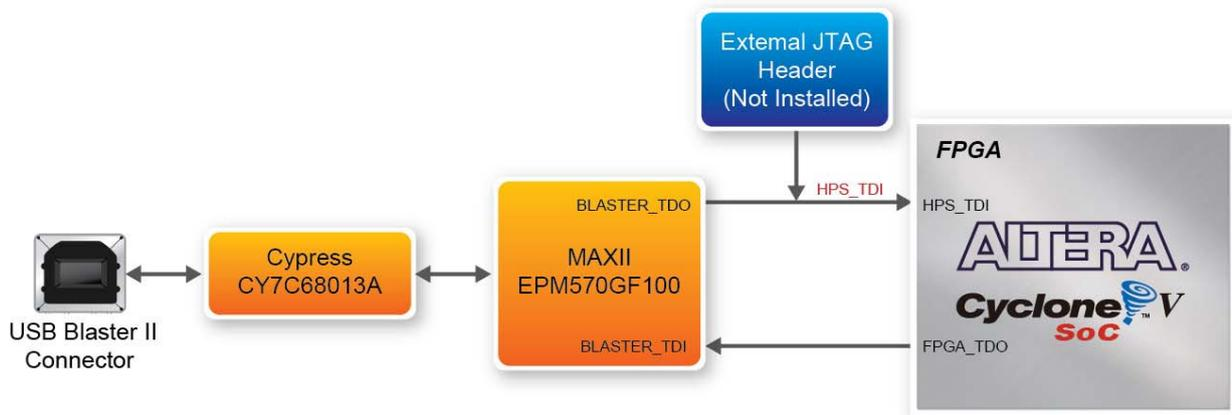
2. AS programming: The other programming method is Active Serial configuration.

The configuration bit stream is downloaded into the quad serial configuration device (EPCQ256), which provides non-volatile storage for the bit stream. The information is retained within EPCQ256

even if the DE1-SoC board is turned off. When the board is powered on, the configuration data in the EPCQ256 device is automatically loaded into the Cyclone V SoC FPGA.

## ■ JTAG Chain on DE1-SoC Board

The FPGA device can be configured through JTAG interface on DE1-SoC board, but the JTAG chain must form a closed loop, which allows Quartus II programmer to detect FPGA device. **Figure 3-2** illustrates the JTAG chain on DE1-SoC board.

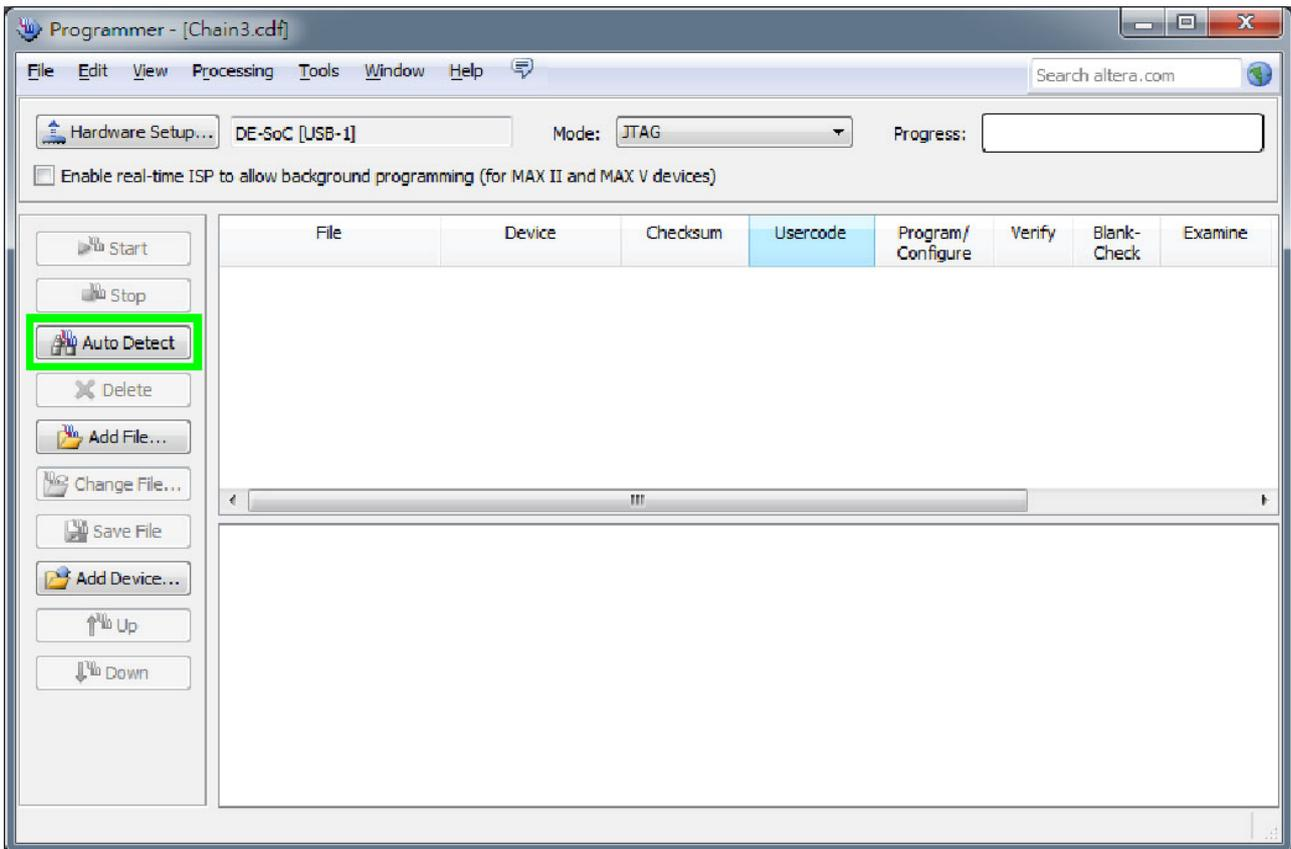


**Figure 3-2 Path of the JTAG chain**

## ■ Configure the FPGA in JTAG Mode

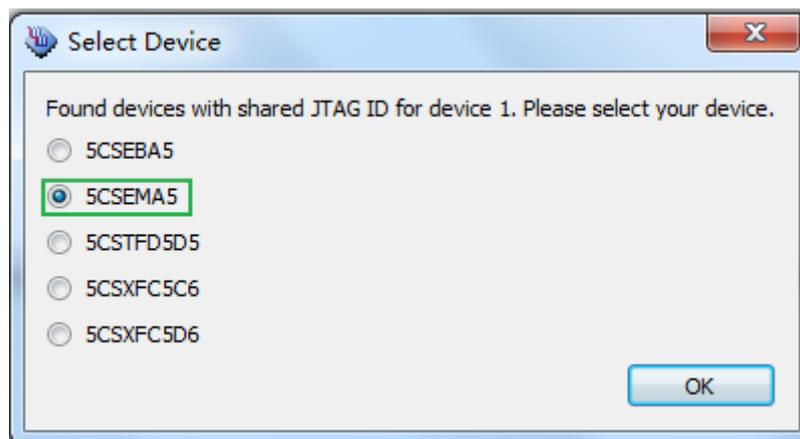
There are two devices (FPGA and HPS) on the JTAG chain. The following shows how the FPGA is programmed in JTAG mode step by step.

1. Open the Quartus II programmer and click “Auto Detect”, as circled in **Figure 3-3**



**Figure 3-3 Detect FPGA device in JTAG mode**

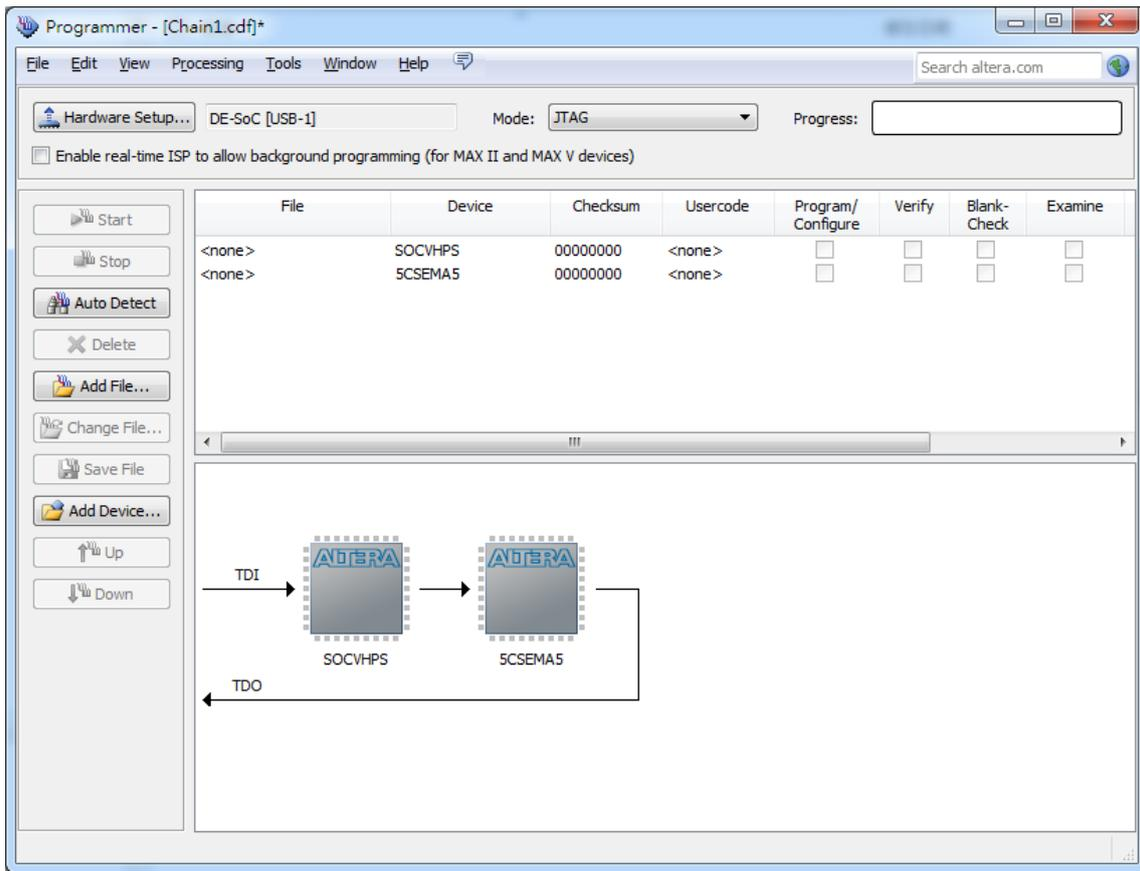
2. Select detected device associated with the board, as circled in **Figure 3-4**.



**Figure 3-4 Select 5CSEMA5 device**

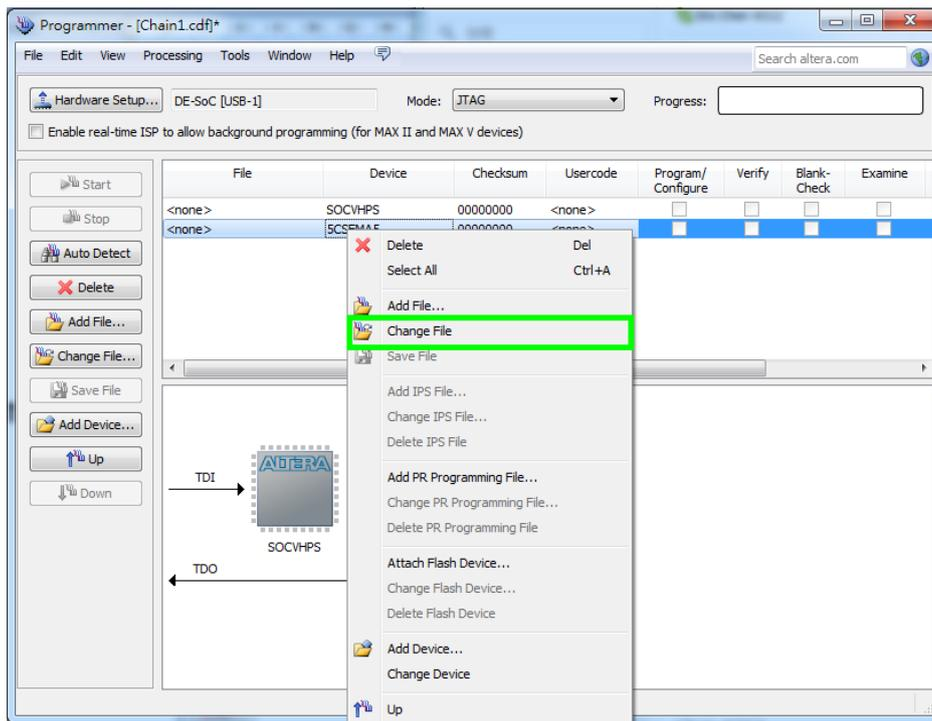
3. Both FPGA and HPS are detected, as shown in **Figure 3-5**.





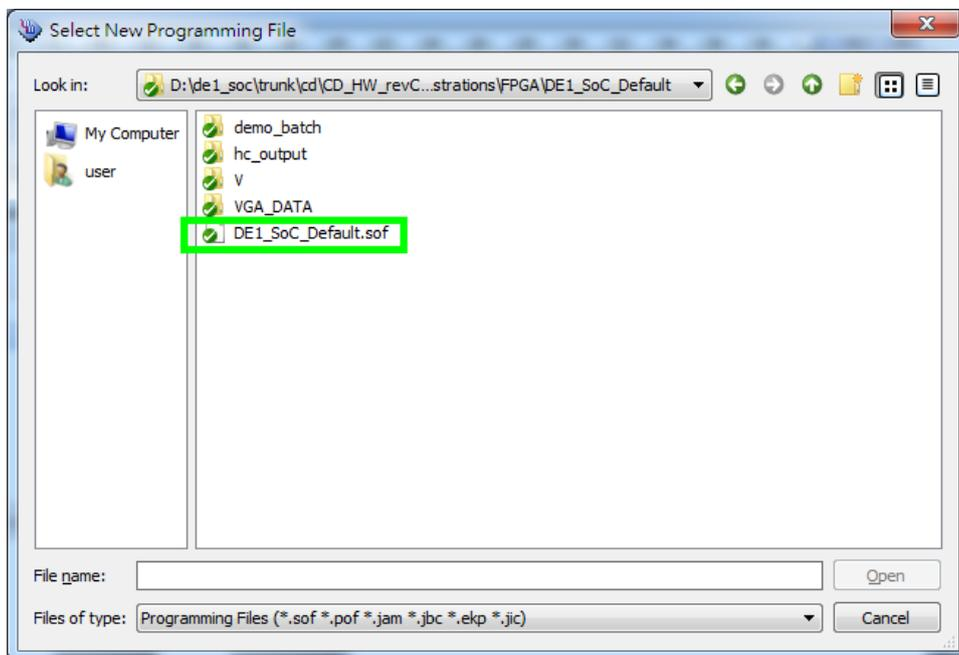
**Figure 3-5 FPGA and HPS detected in Quartus programmer**

4. Right click on the FPGA device and open the .sof file to be programmed, as highlighted in **Figure 3-6**.



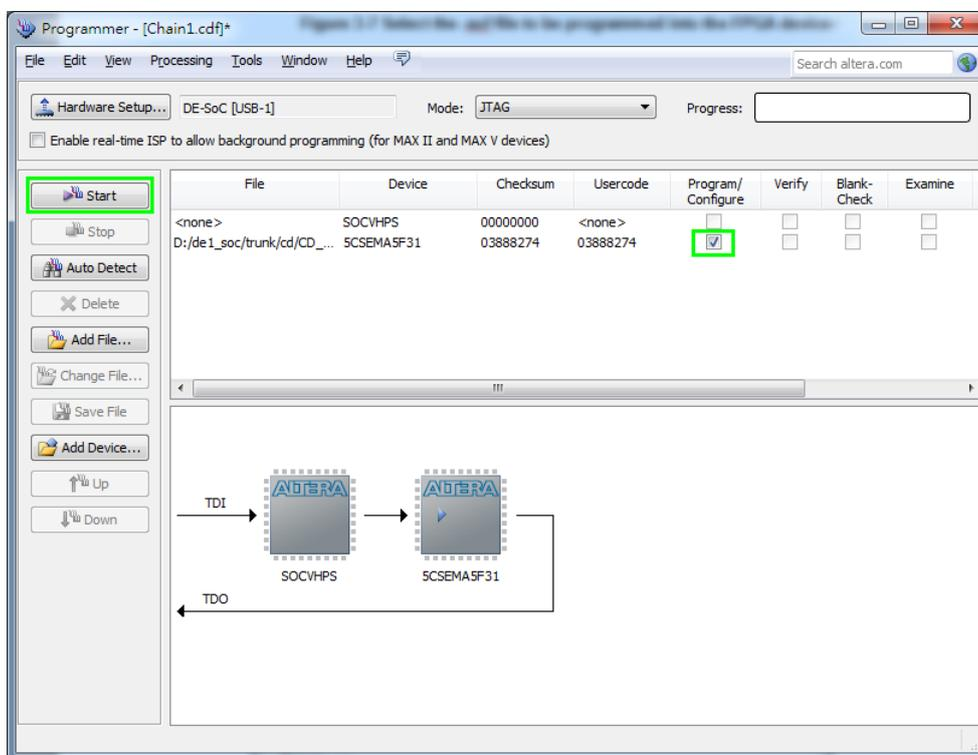
**Figure 3-6** Open the .sof file to be programmed into the FPGA device

5. Select the .sof file to be programmed, as shown in **Figure 3-7**.



**Figure 3-7** Select the .sof file to be programmed into the FPGA device

- Click “Program/Configure” check box and then click “Start” button to download the .sof file into the FPGA device, as shown in **Figure 3-8**.



**Figure 3-8 Program .sof file into the FPGA device**

## ■ Configure the FPGA in AS Mode

- The DE1-SoC board uses a quad serial configuration device (EPCQ256) to store configuration data for the Cyclone V SoC FPGA. This configuration data is automatically loaded from the quad serial configuration device chip into the FPGA when the board is powered up.
- Users need to use Serial Flash Loader (SFL) to program the quad serial configuration device via JTAG interface. The FPGA-based SFL is a soft intellectual property (IP) core within the FPGA that bridge the JTAG and Flash interfaces. The SFL Megafunction is available in Quartus II. **Figure 3-9** shows the programming method when adopting SFL solution.
- Please refer to Chapter 9: Steps of Programming the Quad Serial Configuration Device for the basic programming instruction on the serial configuration device.

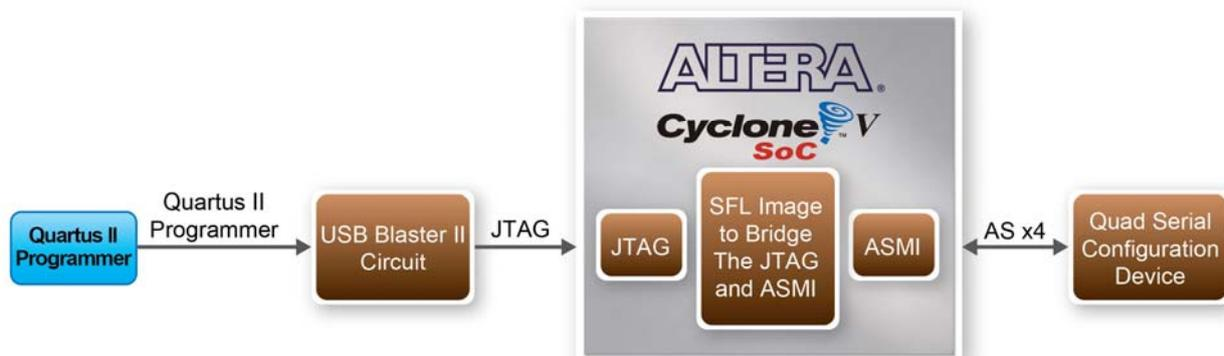


Figure 3-9 Programming a quad serial configuration device with SFL solution

### 3.3 Board Status Elements

In addition to the 10 LEDs that FPGA device can control, there are 5 indicators which can indicate the board status (See Figure 3-10), please refer the details in [Table 3-3](#)

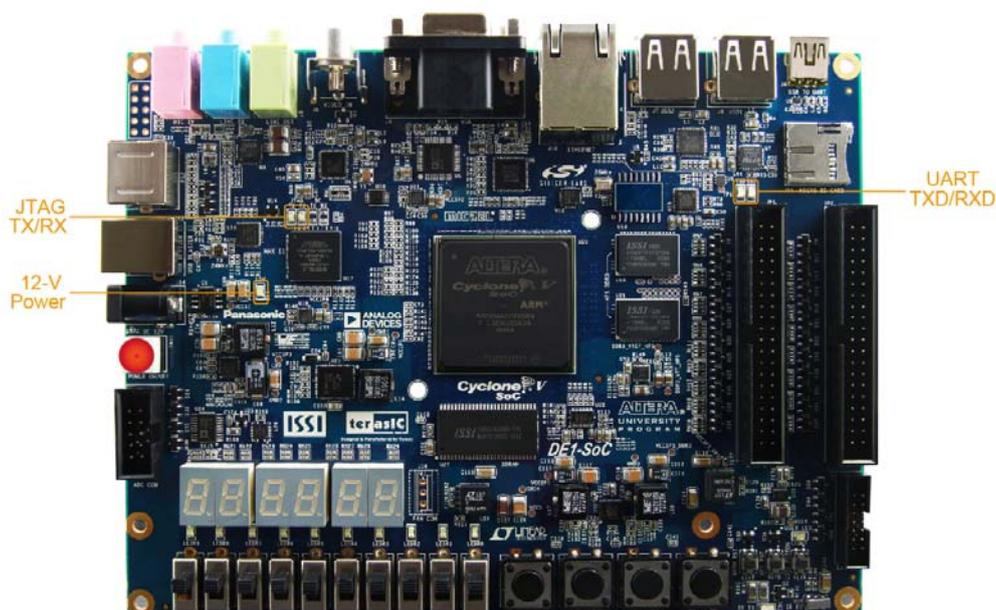


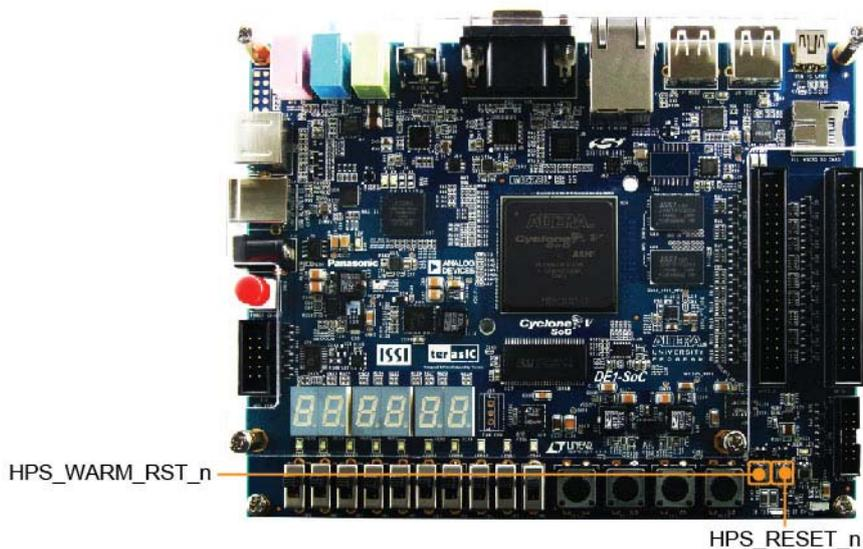
Figure 3-10 LED Indicators on DE1-SoC

**Table 3-3 LED Indicators**

Board Reference	LED Name	Description
D14	12-V Power	Illuminate when 12V power is active.
TXD	UART TXD	Illuminate when data is transferred from FT232R to USB Host.
RXD	UART RXD	Illuminate when data is transferred from USB Host to FT232R.
D5	JTAG_RX	Reserved
D4	JTAG_TX	

### 3.4 Board Reset Elements

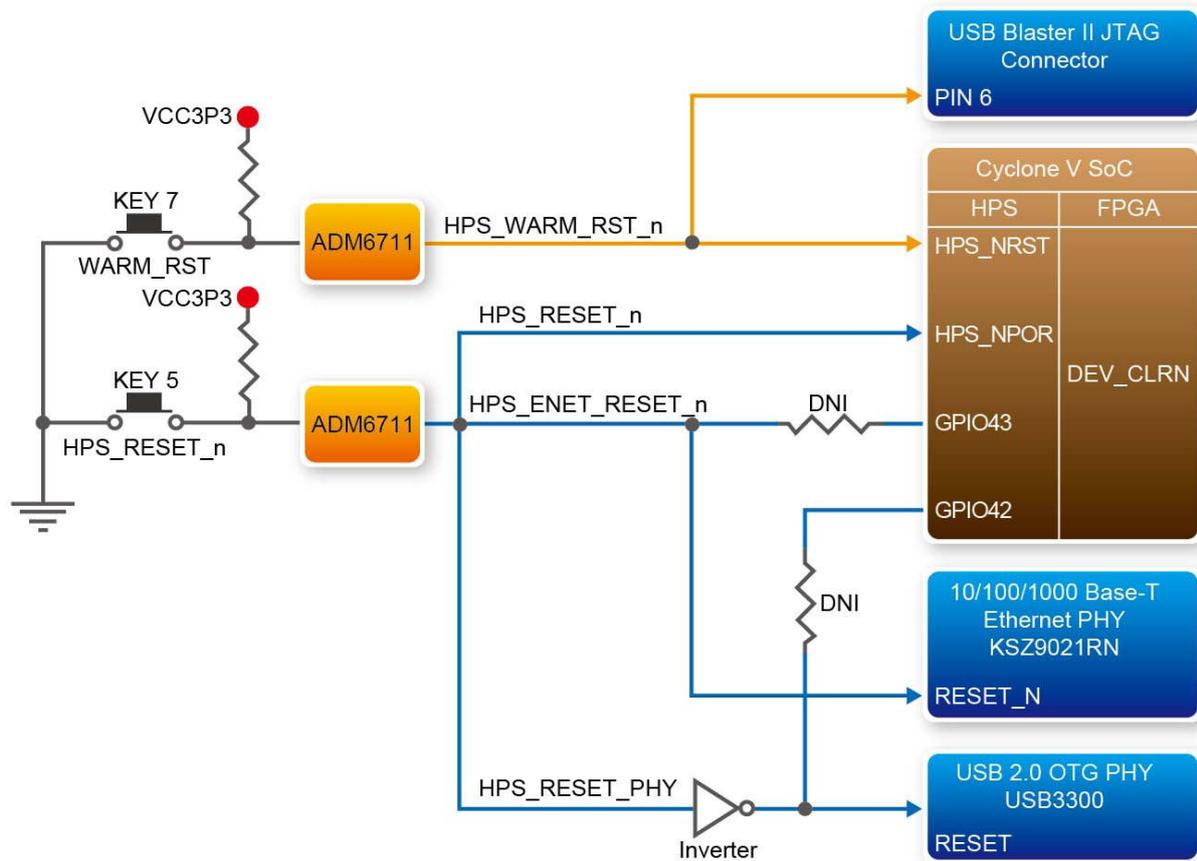
There are two HPS reset buttons on DE1-SoC, HPS (cold) reset and HPS warm reset, as shown in **Figure 3-11**. **Table 3-4** describes the purpose of these two HPS reset buttons. **Figure 3-12** is the reset tree for DE1-SoC.



**Figure 3-11 HPS cold reset and warm reset buttons on DE1-SoC**

**Table 3-4 Description of Two HPS Reset Buttons on DE1-SoC**

Board Reference	Signal Name	Description
KEY5	HPS_RESET_N	Cold reset to the HPS, Ethernet PHY and USB host device. Active low input which resets all HPS logics that can be reset.
KEY7	HPS_WARM_RST_N	Warm reset to the HPS block. Active low input affects the system reset domain for debug purpose.

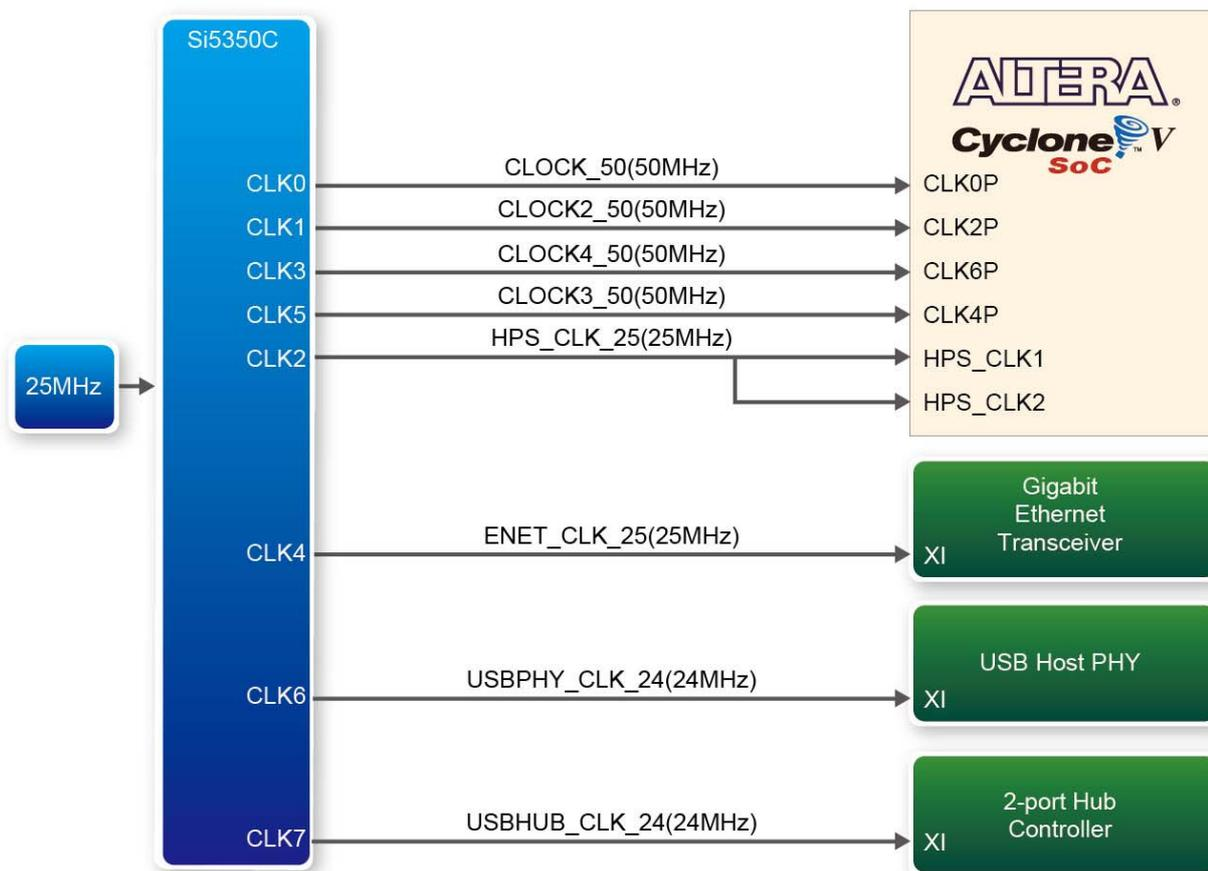


**Figure 3-12 HPS reset tree on DE1-SoC board**

### 3.5 Clock Circuitry

**Figure 3-13** shows the default frequency of all external clocks to the Cyclone V SoC FPGA. A clock generator is used to distribute clock signals with low jitter. The four 50MHz clock signals connected to the FPGA are used as clock sources for user logic. One 25MHz clock signal is connected to two HPS clock inputs, and the other one is connected to the clock input of Gigabit

Ethernet Transceiver. Two 24MHz clock signals are connected to the clock inputs of USB Host/OTG PHY and USB hub controller. The associated pin assignment for clock inputs to FPGA I/O pins is listed in **Table 3-5**.



**Figure 3-13** Block diagram of the clock distribution on DE1-SoC

**Table 3-5** Pin Assignment of Clock Inputs

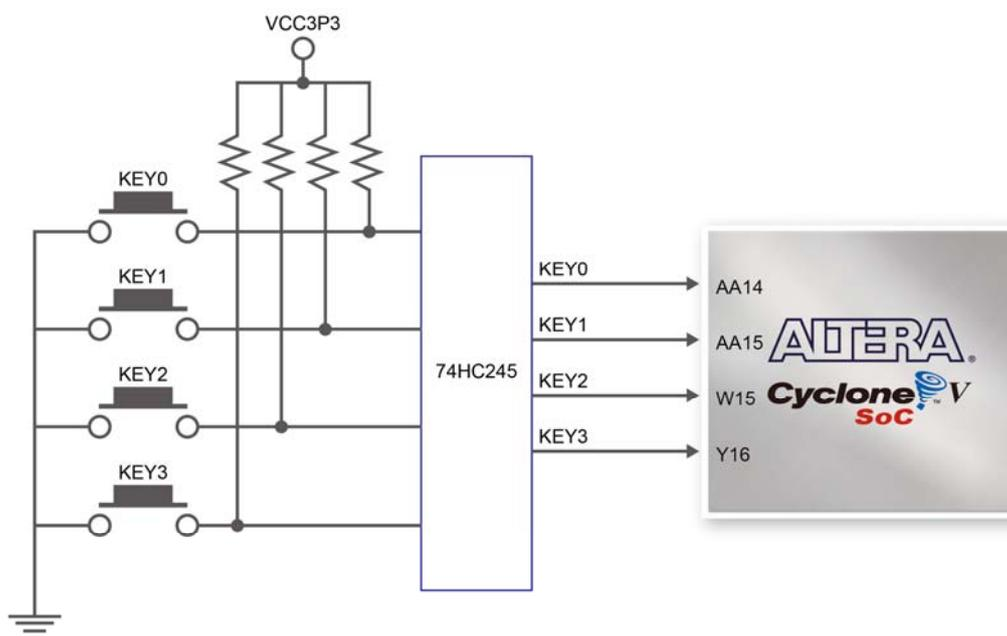
<i>Signal Name</i>	<i>FPGA Pin No.</i>	<i>Description</i>	<i>I/O Standard</i>
CLOCK_50	PIN_AF14	50 MHz clock input	3.3V
CLOCK2_50	PIN_AA16	50 MHz clock input	3.3V
CLOCK3_50	PIN_Y26	50 MHz clock input	3.3V
CLOCK4_50	PIN_K14	50 MHz clock input	3.3V
HPS_CLOCK1_25	PIN_D25	25 MHz clock input	3.3V
HPS_CLOCK2_25	PIN_F25	25 MHz clock input	3.3V

## 3.6 Peripherals Connected to the FPGA

This section describes the interfaces connected to the FPGA. Users can control or monitor different interfaces with user logic from the FPGA.

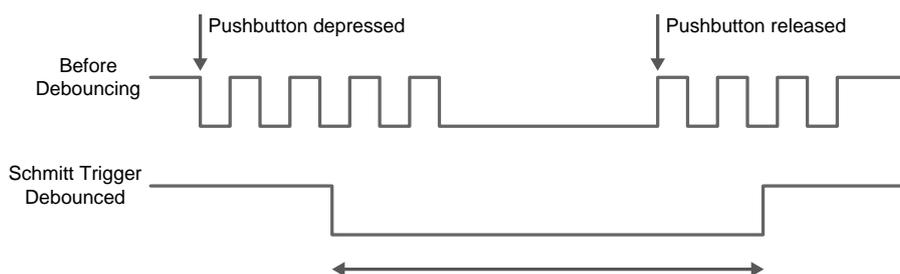
### 3.6.1 User Push-buttons, Switches and LEDs

The board has four push-buttons connected to the FPGA, as shown in **Figure 3-14** Connections between the push-buttons and the Cyclone V SoC FPGA. Schmitt trigger circuit is implemented and act as switch debounce in **Figure 3-15** for the push-buttons connected. The four push-buttons named KEY0, KEY1, KEY2, and KEY3 coming out of the Schmitt trigger device are connected directly to the Cyclone V SoC FPGA. The push-button generates a low logic level or high logic level when it is pressed or not, respectively. Since the push-buttons are debounced, they can be used as clock or reset inputs in a circuit.



**Figure 3-14** Connections between the push-buttons and the Cyclone V SoC FPGA





**Figure 3-15 Switch debouncing**

There are ten slide switches connected to the FPGA, as shown in **Figure 3-16**. These switches are not debounced and to be used as level-sensitive data inputs to a circuit. Each switch is connected directly and individually to the FPGA. When the switch is set to the DOWN position (towards the edge of the board), it generates a low logic level to the FPGA. When the switch is set to the UP position, a high logic level is generated to the FPGA.



**Figure 3-16 Connections between the slide switches and the Cyclone V SoC FPGA**

There are also ten user-controllable LEDs connected to the FPGA. Each LED is driven directly and individually by the Cyclone V SoC FPGA; driving its associated pin to a high logic level or low

level to turn the LED on or off, respectively. **Figure 3-17** shows the connections between LEDs and Cyclone V SoC FPGA. **Table 3-6**, **Table 3-7** and **Table 3-8** list the pin assignment of user push-buttons, switches, and LEDs.



**Figure 3-17** Connections between the LEDs and the Cyclone V SoC FPGA

**Table 3-6** Pin Assignment of Slide Switches

Signal Name	FPGA Pin No.	Description	I/O Standard
SW[0]	PIN_AB12	Slide Switch[0]	3.3V
SW[1]	PIN_AC12	Slide Switch[1]	3.3V
SW[2]	PIN_AF9	Slide Switch[2]	3.3V
SW[3]	PIN_AF10	Slide Switch[3]	3.3V
SW[4]	PIN_AD11	Slide Switch[4]	3.3V
SW[5]	PIN_AD12	Slide Switch[5]	3.3V
SW[6]	PIN_AE11	Slide Switch[6]	3.3V
SW[7]	PIN_AC9	Slide Switch[7]	3.3V
SW[8]	PIN_AD10	Slide Switch[8]	3.3V
SW[9]	PIN_AE12	Slide Switch[9]	3.3V

**Table 3-7** Pin Assignment of Push-buttons

Signal Name	FPGA Pin No.	Description	I/O Standard
KEY[0]	PIN_AA14	Push-button[0]	3.3V
KEY[1]	PIN_AA15	Push-button[1]	3.3V
KEY[2]	PIN_W15	Push-button[2]	3.3V
KEY[3]	PIN_Y16	Push-button[3]	3.3V

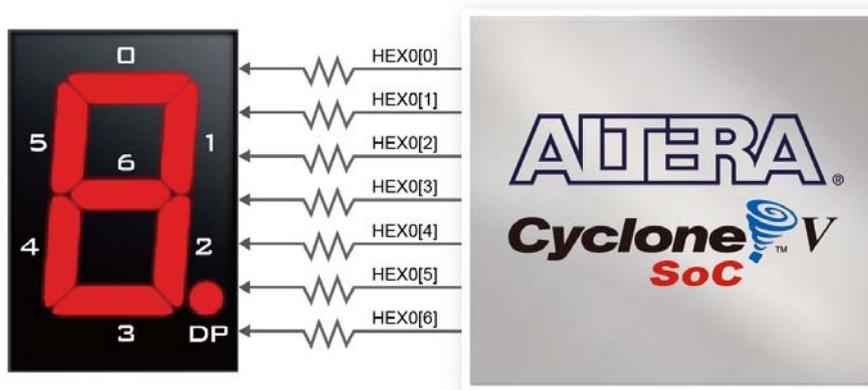
**Table 3-8 Pin Assignment of LEDs**

Signal Name	FPGA Pin No.	Description	I/O Standard
LEDR[0]	PIN_V16	LED [0]	3.3V
LEDR[1]	PIN_W16	LED [1]	3.3V
LEDR[2]	PIN_V17	LED [2]	3.3V
LEDR[3]	PIN_V18	LED [3]	3.3V
LEDR[4]	PIN_W17	LED [4]	3.3V
LEDR[5]	PIN_W19	LED [5]	3.3V
LEDR[6]	PIN_Y19	LED [6]	3.3V
LEDR[7]	PIN_W20	LED [7]	3.3V
LEDR[8]	PIN_W21	LED [8]	3.3V
LEDR[9]	PIN_Y21	LED [9]	3.3V

### 3.6.2 7-segment Displays

The DE1-SoC board has six 7-segment displays. These displays are paired to display numbers in various sizes. **Figure 3-18** shows the connection of seven segments (common anode) to pins on Cyclone V SoC FPGA. The segment can be turned on or off by applying a low logic level or high logic level from the FPGA, respectively.

Each segment in a display is indexed from 0 to 6, with corresponding positions given in **Figure 3-18**. **Table 3-9** shows the pin assignment of FPGA to the 7-segment displays.



**Figure 3-18 Connections between the 7-segment display HEX0 and the Cyclone V SoC FPGA**

**Table 3-9 Pin Assignment of 7-segment Displays**

<i>Signal Name</i>	<i>FPGA Pin No.</i>	<i>Description</i>	<i>I/O Standard</i>
HEX0[0]	PIN_AE26	Seven Segment Digit 0[0]	3.3V
HEX0[1]	PIN_AE27	Seven Segment Digit 0[1]	3.3V
HEX0[2]	PIN_AE28	Seven Segment Digit 0[2]	3.3V
HEX0[3]	PIN_AG27	Seven Segment Digit 0[3]	3.3V
HEX0[4]	PIN_AF28	Seven Segment Digit 0[4]	3.3V
HEX0[5]	PIN_AG28	Seven Segment Digit 0[5]	3.3V
HEX0[6]	PIN_AH28	Seven Segment Digit 0[6]	3.3V
HEX1[0]	PIN_AJ29	Seven Segment Digit 1[0]	3.3V
HEX1[1]	PIN_AH29	Seven Segment Digit 1[1]	3.3V
HEX1[2]	PIN_AH30	Seven Segment Digit 1[2]	3.3V
HEX1[3]	PIN_AG30	Seven Segment Digit 1[3]	3.3V
HEX1[4]	PIN_AF29	Seven Segment Digit 1[4]	3.3V
HEX1[5]	PIN_AF30	Seven Segment Digit 1[5]	3.3V
HEX1[6]	PIN_AD27	Seven Segment Digit 1[6]	3.3V
HEX2[0]	PIN_AB23	Seven Segment Digit 2[0]	3.3V
HEX2[1]	PIN_AE29	Seven Segment Digit 2[1]	3.3V
HEX2[2]	PIN_AD29	Seven Segment Digit 2[2]	3.3V
HEX2[3]	PIN_AC28	Seven Segment Digit 2[3]	3.3V
HEX2[4]	PIN_AD30	Seven Segment Digit 2[4]	3.3V
HEX2[5]	PIN_AC29	Seven Segment Digit 2[5]	3.3V
HEX2[6]	PIN_AC30	Seven Segment Digit 2[6]	3.3V
HEX3[0]	PIN_AD26	Seven Segment Digit 3[0]	3.3V
HEX3[1]	PIN_AC27	Seven Segment Digit 3[1]	3.3V
HEX3[2]	PIN_AD25	Seven Segment Digit 3[2]	3.3V
HEX3[3]	PIN_AC25	Seven Segment Digit 3[3]	3.3V
HEX3[4]	PIN_AB28	Seven Segment Digit 3[4]	3.3V
HEX3[5]	PIN_AB25	Seven Segment Digit 3[5]	3.3V
HEX3[6]	PIN_AB22	Seven Segment Digit 3[6]	3.3V
HEX4[0]	PIN_AA24	Seven Segment Digit 4[0]	3.3V
HEX4[1]	PIN_Y23	Seven Segment Digit 4[1]	3.3V
HEX4[2]	PIN_Y24	Seven Segment Digit 4[2]	3.3V
HEX4[3]	PIN_W22	Seven Segment Digit 4[3]	3.3V
HEX4[4]	PIN_W24	Seven Segment Digit 4[4]	3.3V
HEX4[5]	PIN_V23	Seven Segment Digit 4[5]	3.3V
HEX4[6]	PIN_W25	Seven Segment Digit 4[6]	3.3V
HEX5[0]	PIN_V25	Seven Segment Digit 5[0]	3.3V
HEX5[1]	PIN_AA28	Seven Segment Digit 5[1]	3.3V
HEX5[2]	PIN_Y27	Seven Segment Digit 5[2]	3.3V
HEX5[3]	PIN_AB27	Seven Segment Digit 5[3]	3.3V
HEX5[4]	PIN_AB26	Seven Segment Digit 5[4]	3.3V
HEX5[5]	PIN_AA26	Seven Segment Digit 5[5]	3.3V
HEX5[6]	PIN_AA25	Seven Segment Digit 5[6]	3.3V

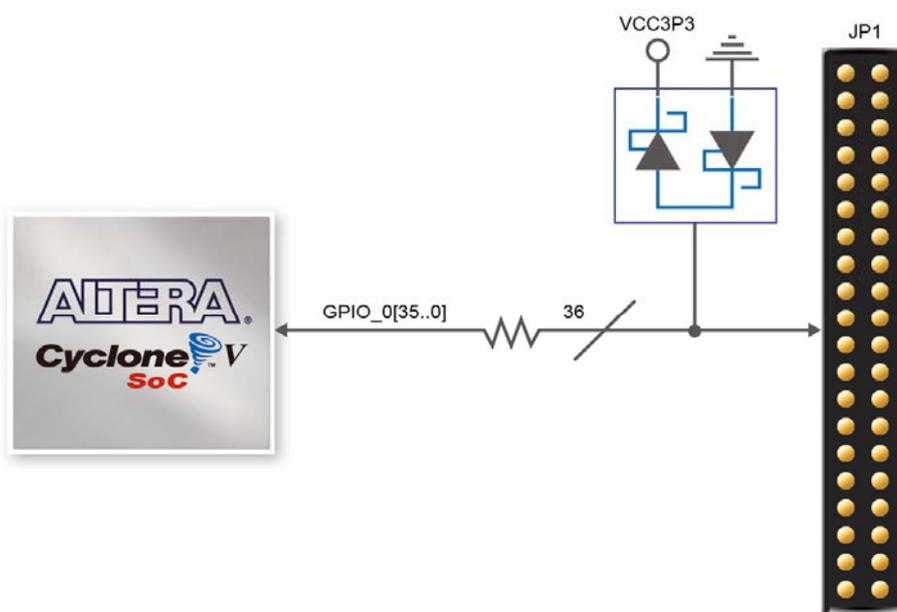
### 3.6.3 2x20 GPIO Expansion Headers

The board has two 40-pin expansion headers. Each header has 36 user pins connected directly to the Cyclone V SoC FPGA. It also comes with DC +5V (VCC5), DC +3.3V (VCC3P3), and two GND pins. The maximum power consumption allowed for a daughter card connected to one or two GPIO ports is shown in **Table 3-10**.

**Table 3-10 Voltage and Max. Current Limit of Expansion Header(s)**

Supplied Voltage	Max. Current Limit
5V	1A
3.3V	1.5A

Each pin on the expansion headers is connected to two diodes and a resistor for protection against high or low voltage level. **Figure 3-19** shows the protection circuitry applied to all 2x36 data pins. **Table 3-11** shows the pin assignment of two GPIO headers.



**Figure 3-19 Connections between the GPIO header and Cyclone V SoC FPGA**

**Table 3-11 Pin Assignment of Expansion Headers**

Signal Name	FPGA Pin No.	Description	I/O Standard
GPIO_0[0]	PIN_AC18	GPIO Connection 0[0]	3.3V
GPIO_0 [1]	PIN_Y17	GPIO Connection 0[1]	3.3V
GPIO_0 [2]	PIN_AD17	GPIO Connection 0[2]	3.3V
GPIO_0 [3]	PIN_Y18	GPIO Connection 0[3]	3.3V

GPIO_0 [4]	PIN_AK16	GPIO Connection 0[4]	3.3V
GPIO_0 [5]	PIN_AK18	GPIO Connection 0[5]	3.3V
GPIO_0 [6]	PIN_AK19	GPIO Connection 0[6]	3.3V
GPIO_0 [7]	PIN_AJ19	GPIO Connection 0[7]	3.3V
GPIO_0 [8]	PIN_AJ17	GPIO Connection 0[8]	3.3V
GPIO_0 [9]	PIN_AJ16	GPIO Connection 0[9]	3.3V
GPIO_0 [10]	PIN_AH18	GPIO Connection 0[10]	3.3V
GPIO_0 [11]	PIN_AH17	GPIO Connection 0[11]	3.3V
GPIO_0 [12]	PIN_AG16	GPIO Connection 0[12]	3.3V
GPIO_0 [13]	PIN_AE16	GPIO Connection 0[13]	3.3V
GPIO_0 [14]	PIN_AF16	GPIO Connection 0[14]	3.3V
GPIO_0 [15]	PIN_AG17	GPIO Connection 0[15]	3.3V
GPIO_0 [16]	PIN_AA18	GPIO Connection 0[16]	3.3V
GPIO_0 [17]	PIN_AA19	GPIO Connection 0[17]	3.3V
GPIO_0 [18]	PIN_AE17	GPIO Connection 0[18]	3.3V
GPIO_0 [19]	PIN_AC20	GPIO Connection 0[19]	3.3V
GPIO_0 [20]	PIN_AH19	GPIO Connection 0[20]	3.3V
GPIO_0 [21]	PIN_AJ20	GPIO Connection 0[21]	3.3V
GPIO_0 [22]	PIN_AH20	GPIO Connection 0[22]	3.3V
GPIO_0 [23]	PIN_AK21	GPIO Connection 0[23]	3.3V
GPIO_0 [24]	PIN_AD19	GPIO Connection 0[24]	3.3V
GPIO_0 [25]	PIN_AD20	GPIO Connection 0[25]	3.3V
GPIO_0 [26]	PIN_AE18	GPIO Connection 0[26]	3.3V
GPIO_0 [27]	PIN_AE19	GPIO Connection 0[27]	3.3V
GPIO_0 [28]	PIN_AF20	GPIO Connection 0[28]	3.3V
GPIO_0 [29]	PIN_AF21	GPIO Connection 0[29]	3.3V
GPIO_0 [30]	PIN_AF19	GPIO Connection 0[30]	3.3V
GPIO_0 [31]	PIN_AG21	GPIO Connection 0[31]	3.3V
GPIO_0 [32]	PIN_AF18	GPIO Connection 0[32]	3.3V
GPIO_0 [33]	PIN_AG20	GPIO Connection 0[33]	3.3V
GPIO_0 [34]	PIN_AG18	GPIO Connection 0[34]	3.3V
GPIO_0 [35]	PIN_AJ21	GPIO Connection 0[35]	3.3V
GPIO_1 [0]	PIN_AB17	GPIO Connection 1[0]	3.3V
GPIO_1 [1]	PIN_AA21	GPIO Connection 1[1]	3.3V
GPIO_1 [2]	PIN_AB21	GPIO Connection 1[2]	3.3V
GPIO_1 [3]	PIN_AC23	GPIO Connection 1[3]	3.3V
GPIO_1 [4]	PIN_AD24	GPIO Connection 1[4]	3.3V
GPIO_1 [5]	PIN_AE23	GPIO Connection 1[5]	3.3V
GPIO_1 [6]	PIN_AE24	GPIO Connection 1[6]	3.3V
GPIO_1 [7]	PIN_AF25	GPIO Connection 1[7]	3.3V
GPIO_1 [8]	PIN_AF26	GPIO Connection 1[8]	3.3V
GPIO_1 [9]	PIN_AG25	GPIO Connection 1[9]	3.3V
GPIO_1 [10]	PIN_AG26	GPIO Connection 1[10]	3.3V
GPIO_1 [11]	PIN_AH24	GPIO Connection 1[11]	3.3V

GPIO_1 [12]	PIN_AH27	GPIO Connection 1[12]	3.3V
GPIO_1 [13]	PIN_AJ27	GPIO Connection 1[13]	3.3V
GPIO_1 [14]	PIN_AK29	GPIO Connection 1[14]	3.3V
GPIO_1 [15]	PIN_AK28	GPIO Connection 1[15]	3.3V
GPIO_1 [16]	PIN_AK27	GPIO Connection 1[16]	3.3V
GPIO_1 [17]	PIN_AJ26	GPIO Connection 1[17]	3.3V
GPIO_1 [18]	PIN_AK26	GPIO Connection 1[18]	3.3V
GPIO_1 [19]	PIN_AH25	GPIO Connection 1[19]	3.3V
GPIO_1 [20]	PIN_AJ25	GPIO Connection 1[20]	3.3V
GPIO_1 [21]	PIN_AJ24	GPIO Connection 1[21]	3.3V
GPIO_1 [22]	PIN_AK24	GPIO Connection 1[22]	3.3V
GPIO_1 [23]	PIN_AG23	GPIO Connection 1[23]	3.3V
GPIO_1 [24]	PIN_AK23	GPIO Connection 1[24]	3.3V
GPIO_1 [25]	PIN_AH23	GPIO Connection 1[25]	3.3V
GPIO_1 [26]	PIN_AK22	GPIO Connection 1[26]	3.3V
GPIO_1 [27]	PIN_AJ22	GPIO Connection 1[27]	3.3V
GPIO_1 [28]	PIN_AH22	GPIO Connection 1[28]	3.3V
GPIO_1 [29]	PIN_AG22	GPIO Connection 1[29]	3.3V
GPIO_1 [30]	PIN_AF24	GPIO Connection 1[30]	3.3V
GPIO_1 [31]	PIN_AF23	GPIO Connection 1[31]	3.3V
GPIO_1 [32]	PIN_AE22	GPIO Connection 1[32]	3.3V
GPIO_1 [33]	PIN_AD21	GPIO Connection 1[33]	3.3V
GPIO_1 [34]	PIN_AA20	GPIO Connection 1[34]	3.3V
GPIO_1 [35]	PIN_AC22	GPIO Connection 1[35]	3.3V

### 3.6.4 24-bit Audio CODEC

The DE1-SoC board offers high-quality 24-bit audio via the Wolfson WM8731 audio CODEC (Encoder/Decoder). This chip supports microphone-in, line-in, and line-out ports, with adjustable sample rate from 8 kHz to 96 kHz. The WM8731 is controlled via serial I2C bus, which is connected to HPS or Cyclone V SoC FPGA through an I2C multiplexer. The connection of the audio circuitry to the FPGA is shown in [Figure 3-20](#), and the associated pin assignment to the FPGA is listed in [Table 3-12](#). More information about the WM8731 codec is available in its datasheet, which can be found on the manufacturer’s website, or in the directory `\DE1_SOC_datasheets\Audio CODEC` of DE1-SoC System CD.

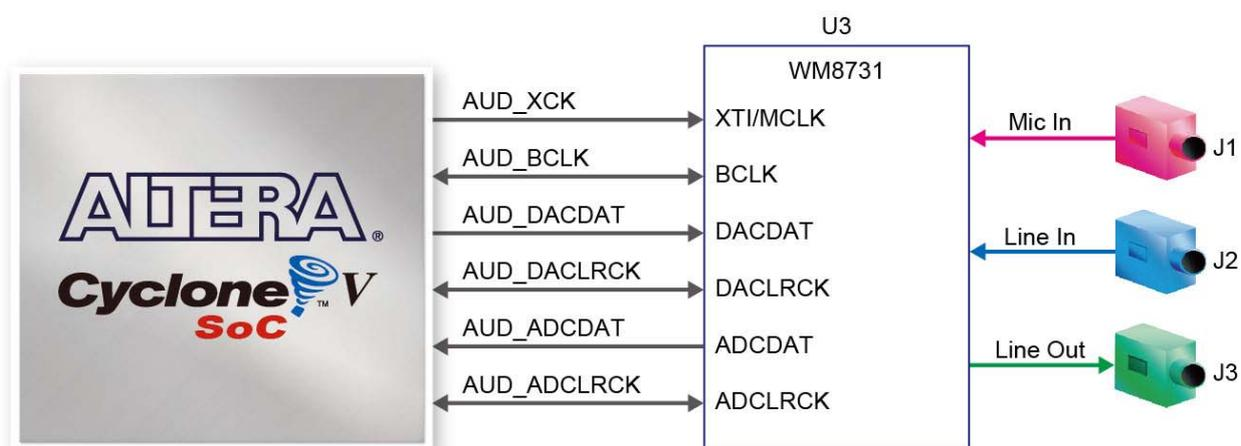


Figure 3-20 Connections between the FPGA and audio CODEC

Table 3-12 Pin Assignment of Audio CODEC

Signal Name	FPGA Pin No.	Description	I/O Standard
AUD_ADCLK	PIN_K8	Audio CODEC ADC LR Clock	3.3V
AUD_ADCCDAT	PIN_K7	Audio CODEC ADC Data	3.3V
AUD_DACLK	PIN_H8	Audio CODEC DAC LR Clock	3.3V
AUD_DACDAT	PIN_J7	Audio CODEC DAC Data	3.3V
AUD_XCK	PIN_G7	Audio CODEC Chip Clock	3.3V
AUD_BCLK	PIN_H7	Audio CODEC Bit-stream Clock	3.3V
I2C_SCLK	PIN_J12 or PIN_E23	I2C Clock	3.3V
I2C_SDAT	PIN_K12 or PIN_C24	I2C Data	3.3V

### 3.6.5 I2C Multiplexer

The DE1-SoC board implements an I2C multiplexer for HPS to access the I2C bus originally owned by FPGA. **Figure 3-21** shows the connection of I2C multiplexer to the FPGA and HPS. HPS can access Audio CODEC and TV Decoder if and only if the HPS\_I2C\_CONTROL signal is set to high. The pin assignment of I2C bus is listed in **Table 3-13** .



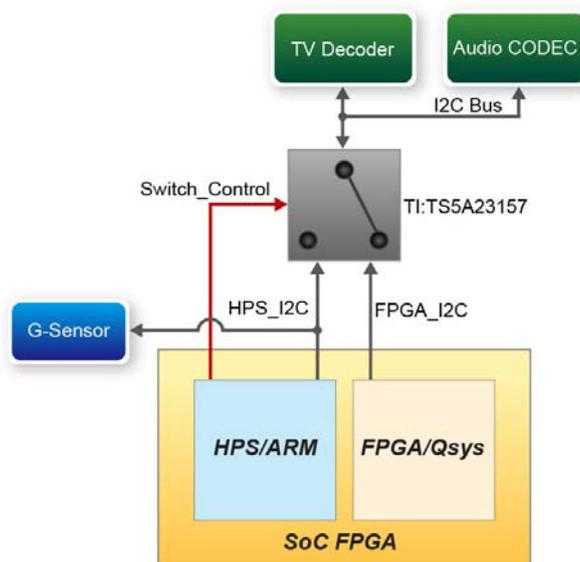


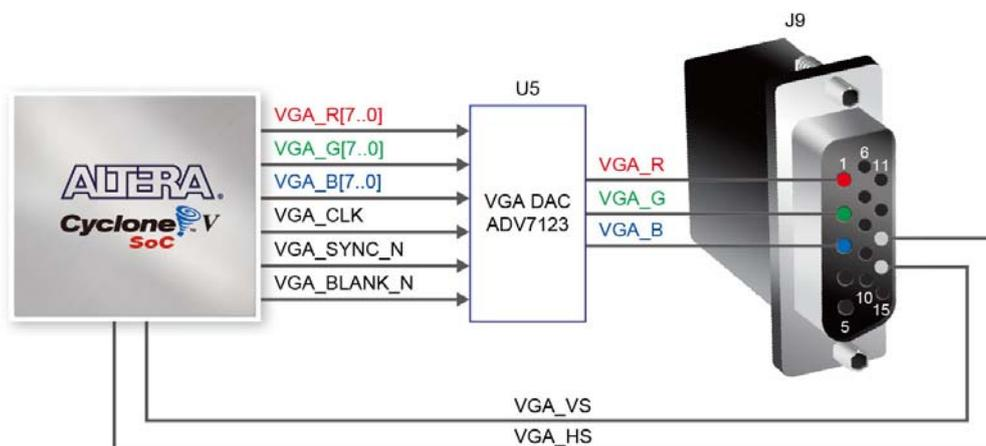
Figure 3-21 Control mechanism for the I2C multiplexer

Table 3-13 Pin Assignment of I2C Bus

Signal Name	FPGA Pin No.	Description	I/O Standard
FPGA_I2C_SCLK	PIN_J12	FPGA I2C Clock	3.3V
FPGA_I2C_SDAT	PIN_K12	FPGA I2C Data	3.3V
HPS_I2C1_SCLK	PIN_E23	I2C Clock of the first HPS I2C concontroller	3.3V
HPS_I2C1_SDAT	PIN_C24	I2C Data of the first HPS I2C concontroller	3.3V
HPS_I2C2_SCLK	PIN_H23	I2C Clock of the second HPS I2C concontroller	3.3V
HPS_I2C2_SDAT	PIN_A25	I2C Data of the second HPS I2C concontroller	3.3V

### 3.6.6 VGA

The DE1-SoC board has a 15-pin D-SUB connector populated for VGA output. The VGA synchronization signals are generated directly from the Cyclone V SoC FPGA, and the Analog Devices ADV7123 triple 10-bit high-speed video DAC (only the higher 8-bits are used) transforms signals from digital to analog to represent three fundamental colors (red, green, and blue). It can support up to SXGA standard (1280\*1024) with signals transmitted at 100MHz. **Figure 3-22** shows the signals connected between the FPGA and VGA.



**Figure 3-22 Connections between the FPGA and VGA**

The timing specification for VGA synchronization and RGB (red, green, blue) data can be easily found on website nowadays. **Figure 3-22** illustrates the basic timing requirements for each row (horizontal) displayed on a VGA monitor. An active-low pulse of specific duration is applied to the horizontal synchronization (hsync) input of the monitor, which signifies the end of one row of data and the start of the next. The data (RGB) output to the monitor must be off (driven to 0 V) for a time period called the back porch (b) after the hsync pulse occurs, which is followed by the display interval (c). During the data display interval the RGB data drives each pixel in turn across the row being displayed. Finally, there is a time period called the front porch (d) where the RGB signals must again be off before the next hsync pulse can occur. The timing of vertical synchronization (vsync) is similar to the one shown in **Figure 3-23**, except that a vsync pulse signifies the end of one frame and the start of the next, and the data refers to the set of rows in the frame (horizontal timing). **Table 3-14** and **Table 3-15** show different resolutions and durations of time period a, b, c, and d for both horizontal and vertical timing.

More information about the ADV7123 video DAC is available in its datasheet, which can be found on the manufacturer's website, or in the directory \Datasheets\VIDEO DAC of DE1-SoC System CD. The pin assignment between the Cyclone V SoC FPGA and the ADV7123 is listed in **Table 3-16**.

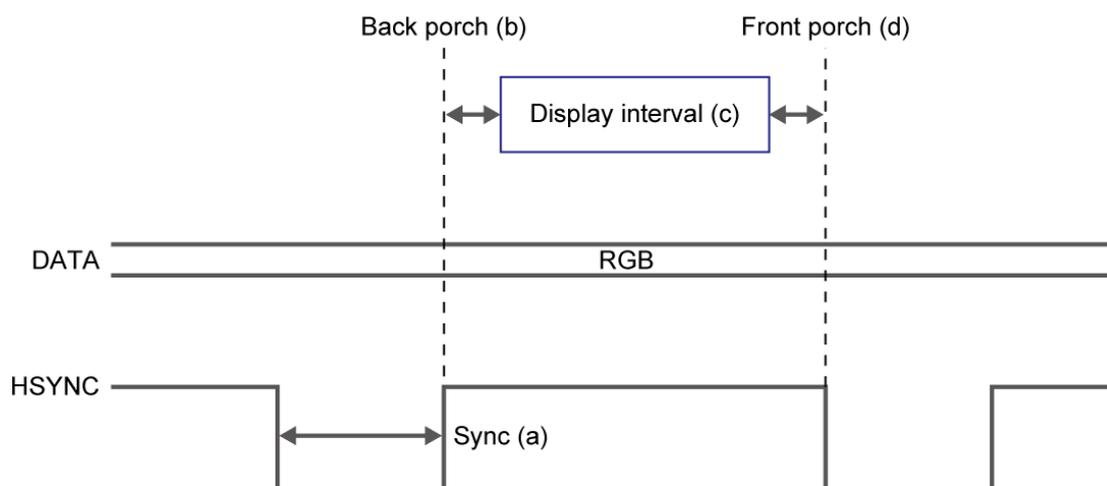


Figure 3-23 VGA horizontal timing specification

Table 3-14 VGA Horizontal Timing Specification

VGA mode		Horizontal Timing Spec				
Configuration	Resolution(HxV)	a(us)	b(us)	c(us)	d(us)	Pixel clock(MHz)
VGA(60Hz)	640x480	3.8	1.9	25.4	0.6	25
VGA(85Hz)	640x480	1.6	2.2	17.8	1.6	36
SVGA(60Hz)	800x600	3.2	2.2	20	1	40
SVGA(75Hz)	800x600	1.6	3.2	16.2	0.3	49
SVGA(85Hz)	800x600	1.1	2.7	14.2	0.6	56
XGA(60Hz)	1024x768	2.1	2.5	15.8	0.4	65
XGA(70Hz)	1024x768	1.8	1.9	13.7	0.3	75
XGA(85Hz)	1024x768	1.0	2.2	10.8	0.5	95
1280x1024(60Hz)	1280x1024	1.0	2.3	11.9	0.4	108

Table 3-15 VGA Vertical Timing Specification

VGA mode		Vertical Timing Spec				
Configuration	Resolution(HxV)	a(lines)	b(lines)	c(lines)	d(lines)	Pixel clock(MHz)
VGA(60Hz)	640x480	2	33	480	10	25
VGA(85Hz)	640x480	3	25	480	1	36
SVGA(60Hz)	800x600	4	23	600	1	40
SVGA(75Hz)	800x600	3	21	600	1	49
SVGA(85Hz)	800x600	3	27	600	1	56
XGA(60Hz)	1024x768	6	29	768	3	65
XGA(70Hz)	1024x768	6	29	768	3	75
XGA(85Hz)	1024x768	3	36	768	1	95
1280x1024(60Hz)	1280x1024	3	38	1024	1	108

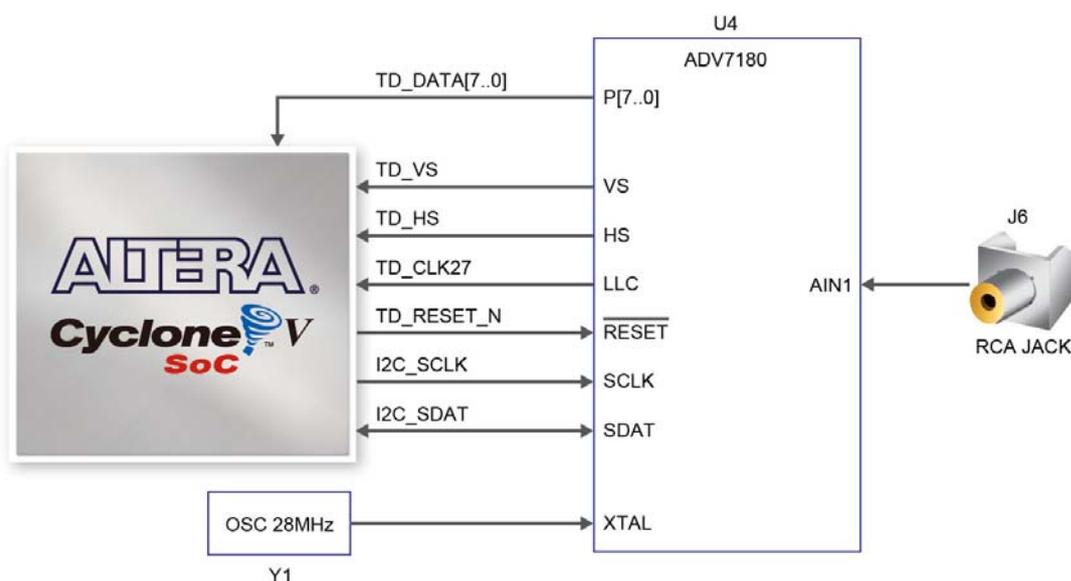
**Table 3-16 Pin Assignment of VGA**

<i>Signal Name</i>	<i>FPGA Pin No.</i>	<i>Description</i>	<i>I/O Standard</i>
VGA_R[0]	PIN_A13	VGA Red[0]	3.3V
VGA_R[1]	PIN_C13	VGA Red[1]	3.3V
VGA_R[2]	PIN_E13	VGA Red[2]	3.3V
VGA_R[3]	PIN_B12	VGA Red[3]	3.3V
VGA_R[4]	PIN_C12	VGA Red[4]	3.3V
VGA_R[5]	PIN_D12	VGA Red[5]	3.3V
VGA_R[6]	PIN_E12	VGA Red[6]	3.3V
VGA_R[7]	PIN_F13	VGA Red[7]	3.3V
VGA_G[0]	PIN_J9	VGA Green[0]	3.3V
VGA_G[1]	PIN_J10	VGA Green[1]	3.3V
VGA_G[2]	PIN_H12	VGA Green[2]	3.3V
VGA_G[3]	PIN_G10	VGA Green[3]	3.3V
VGA_G[4]	PIN_G11	VGA Green[4]	3.3V
VGA_G[5]	PIN_G12	VGA Green[5]	3.3V
VGA_G[6]	PIN_F11	VGA Green[6]	3.3V
VGA_G[7]	PIN_E11	VGA Green[7]	3.3V
VGA_B[0]	PIN_B13	VGA Blue[0]	3.3V
VGA_B[1]	PIN_G13	VGA Blue[1]	3.3V
VGA_B[2]	PIN_H13	VGA Blue[2]	3.3V
VGA_B[3]	PIN_F14	VGA Blue[3]	3.3V
VGA_B[4]	PIN_H14	VGA Blue[4]	3.3V
VGA_B[5]	PIN_F15	VGA Blue[5]	3.3V
VGA_B[6]	PIN_G15	VGA Blue[6]	3.3V
VGA_B[7]	PIN_J14	VGA Blue[7]	3.3V
VGA_CLK	PIN_A11	VGA Clock	3.3V
VGA_BLANK_N	PIN_F10	VGA BLANK	3.3V
VGA_HS	PIN_B11	VGA H_SYNC	3.3V
VGA_VS	PIN_D11	VGA V_SYNC	3.3V
VGA_SYNC_N	PIN_C10	VGA SYNC	3.3V

### 3.6.7 TV Decoder

The DE1-SoC board is equipped with an Analog Device ADV7180 TV decoder chip. The ADV7180 is an integrated video decoder which automatically detects and converts a standard analog baseband television signals (NTSC, PAL, and SECAM) into 4:2:2 component video data, which is compatible with the 8-bit ITU-R BT.656 interface standard. The ADV7180 is compatible with wide range of video devices, including DVD players, tape-based sources, broadcast sources, and security/surveillance cameras.

The registers in the TV decoder can be accessed and set through serial I2C bus by the Cyclone V SoC FPGA or HPS. Note that the I2C address W/R of the TV decoder (U4) is 0x40/0x41. The pin assignment of TV decoder is listed in **Table 3-17**. More information about the ADV7180 is available on the manufacturer’s website, or in the directory \DE1\_SOC\_datasheets\Video Decoder of DE1-SoC System CD.



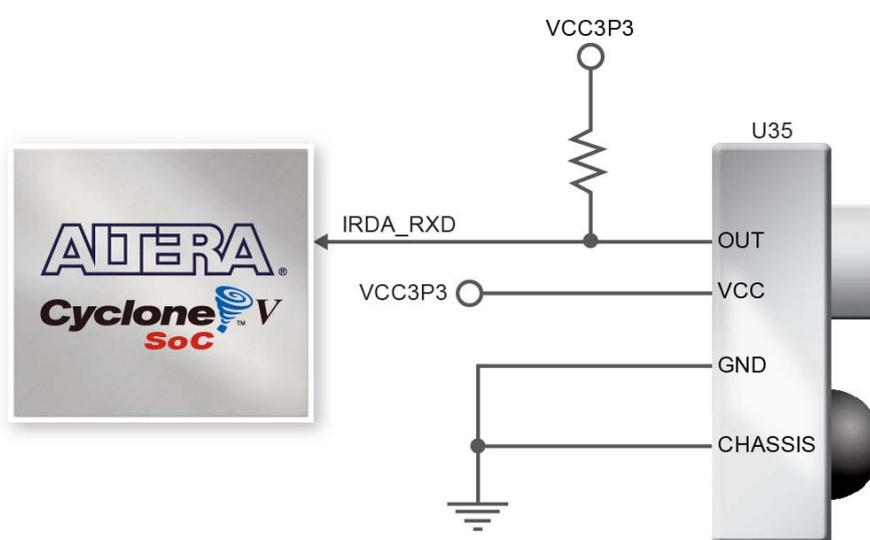
**Figure 3-24 Connections between the FPGA and TV Decoder**

**Table 3-17 Pin Assignment of TV Decoder**

Signal Name	FPGA Pin No.	Description	I/O Standard
TD_DATA [0]	PIN_D2	TV Decoder Data[0]	3.3V
TD_DATA [1]	PIN_B1	TV Decoder Data[1]	3.3V
TD_DATA [2]	PIN_E2	TV Decoder Data[2]	3.3V
TD_DATA [3]	PIN_B2	TV Decoder Data[3]	3.3V
TD_DATA [4]	PIN_D1	TV Decoder Data[4]	3.3V
TD_DATA [5]	PIN_E1	TV Decoder Data[5]	3.3V
TD_DATA [6]	PIN_C2	TV Decoder Data[6]	3.3V
TD_DATA [7]	PIN_B3	TV Decoder Data[7]	3.3V
TD_HS	PIN_A5	TV Decoder H_SYNC	3.3V
TD_VS	PIN_A3	TV Decoder V_SYNC	3.3V
TD_CLK27	PIN_H15	TV Decoder Clock Input.	3.3V
TD_RESET_N	PIN_F6	TV Decoder Reset	3.3V
I2C_SCLK	PIN_J12 or PIN_E23	I2C Clock	3.3V
I2C_SDAT	PIN_K12 or PIN_C24	I2C Data	3.3V

### 3.6.8 IR Receiver

The board comes with an infrared remote-control receiver module (model: IRM-V538/TR1), whose datasheet is provided in the directory \Datasheets\ IR Receiver and Emitter of DE1-SoC system CD. The remote controller included in the kit has an encoding chip (uPD6121G) built-in for generating infrared signals. **Figure 3-25** shows the connection of IR receiver to the FPGA. **Table 3-18** shows the pin assignment of IR receiver to the FPGA.



**Figure 3-25 Connection between the FPGA and IR Receiver**

**Table 3-18 Pin Assignment of IR Receiver**

Signal Name	FPGA Pin No.	Description	I/O Standard
IRDA_RXD	PIN_AA30	IR Receiver	3.3V

### 3.6.9 IR Emitter LED

The board has an IR emitter LED for IR communication, which is widely used for operating television device wirelessly from a short line-of-sight distance. It can also be used to communicate with other systems by matching this IR emitter LED with another IR receiver on the other side. **Figure 3-26** shows the connection of IR emitter LED to the FPGA. **Table 3-19** shows the pin assignment of IR emitter LED to the FPGA.

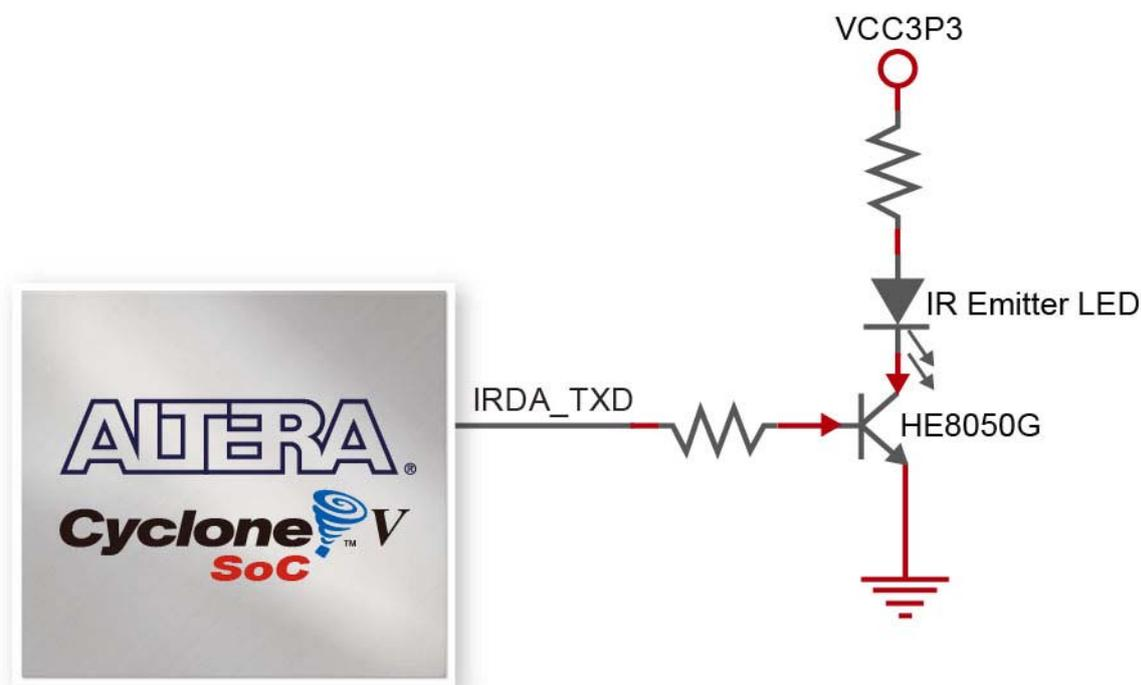


Figure 3-26 Connection between the FPGA and IR emitter LED

Table 3-19 Pin Assignment of IR Emitter LED

Signal Name	FPGA Pin No.	Description	I/O Standard
IRDA_TXD	PIN_AB30	IR Emitter	3.3V

### 3.6.10 SDRAM Memory

The board features 64MB of SDRAM with a single 64MB (32Mx16) SDRAM chip. The chip consists of 16-bit data line, control line, and address line connected to the FPGA. This chip uses the 3.3V LVCMOS signaling standard. Connections between the FPGA and SDRAM are shown in **Figure 3-27**, and the pin assignment is listed in **Table 3-20**.



Figure 3-27 Connections between the FPGA and SDRAM

Table 3-20 Pin Assignment of SDRAM

Signal Name	FPGA Pin No.	Description	I/O Standard
DRAM_ADDR[0]	PIN_AK14	SDRAM Address[0]	3.3V
DRAM_ADDR[1]	PIN_AH14	SDRAM Address[1]	3.3V
DRAM_ADDR[2]	PIN_AG15	SDRAM Address[2]	3.3V
DRAM_ADDR[3]	PIN_AE14	SDRAM Address[3]	3.3V
DRAM_ADDR[4]	PIN_AB15	SDRAM Address[4]	3.3V
DRAM_ADDR[5]	PIN_AC14	SDRAM Address[5]	3.3V
DRAM_ADDR[6]	PIN_AD14	SDRAM Address[6]	3.3V
DRAM_ADDR[7]	PIN_AF15	SDRAM Address[7]	3.3V
DRAM_ADDR[8]	PIN_AH15	SDRAM Address[8]	3.3V
DRAM_ADDR[9]	PIN_AG13	SDRAM Address[9]	3.3V
DRAM_ADDR[10]	PIN_AG12	SDRAM Address[10]	3.3V
DRAM_ADDR[11]	PIN_AH13	SDRAM Address[11]	3.3V
DRAM_ADDR[12]	PIN_AJ14	SDRAM Address[12]	3.3V
DRAM_DQ[0]	PIN_AK6	SDRAM Data[0]	3.3V
DRAM_DQ[1]	PIN_AJ7	SDRAM Data[1]	3.3V
DRAM_DQ[2]	PIN_AK7	SDRAM Data[2]	3.3V
DRAM_DQ[3]	PIN_AK8	SDRAM Data[3]	3.3V
DRAM_DQ[4]	PIN_AK9	SDRAM Data[4]	3.3V
DRAM_DQ[5]	PIN_AG10	SDRAM Data[5]	3.3V



DRAM_DQ[6]	PIN_AK11	SDRAM Data[6]	3.3V
DRAM_DQ[7]	PIN_AJ11	SDRAM Data[7]	3.3V
DRAM_DQ[8]	PIN_AH10	SDRAM Data[8]	3.3V
DRAM_DQ[9]	PIN_AJ10	SDRAM Data[9]	3.3V
DRAM_DQ[10]	PIN_AJ9	SDRAM Data[10]	3.3V
DRAM_DQ[11]	PIN_AH9	SDRAM Data[11]	3.3V
DRAM_DQ[12]	PIN_AH8	SDRAM Data[12]	3.3V
DRAM_DQ[13]	PIN_AH7	SDRAM Data[13]	3.3V
DRAM_DQ[14]	PIN_AJ6	SDRAM Data[14]	3.3V
DRAM_DQ[15]	PIN_AJ5	SDRAM Data[15]	3.3V
DRAM_BA[0]	PIN_AF13	SDRAM Bank Address[0]	3.3V
DRAM_BA[1]	PIN_AJ12	SDRAM Bank Address[1]	3.3V
DRAM_LDQM	PIN_AB13	SDRAM byte Data Mask[0]	3.3V
DRAM_UDQM	PIN_AK12	SDRAM byte Data Mask[1]	3.3V
DRAM_RAS_N	PIN_AE13	SDRAM Row Address Strobe	3.3V
DRAM_CAS_N	PIN_AF11	SDRAM Column Address Strobe	3.3V
DRAM_CKE	PIN_AK13	SDRAM Clock Enable	3.3V
DRAM_CLK	PIN_AH12	SDRAM Clock	3.3V
DRAM_WE_N	PIN_AA13	SDRAM Write Enable	3.3V
DRAM_CS_N	PIN_AG11	SDRAM Chip Select	3.3V

### 3.6.11 PS/2 Serial Port

The DE1-SoC board comes with a standard PS/2 interface and a connector for a PS/2 keyboard or mouse. **Figure 3-28** shows the connection of PS/2 circuit to the FPGA. Users can use the PS/2 keyboard and mouse on the DE1-SoC board simultaneously by a PS/2 Y-Cable, as shown in **Figure 3-29**. Instructions on how to use PS/2 mouse and/or keyboard can be found on various educational websites. The pin assignment associated to this interface is shown in **Table 3-21**.



*Note: If users connect only one PS/2 equipment, the PS/2 signals connected to the FPGA I/O should be "PS2\_CLK" and "PS2\_DAT".*

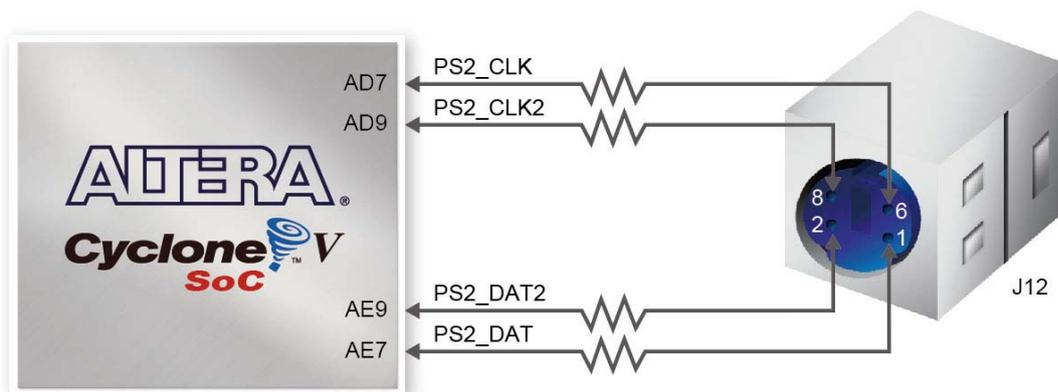


Figure 3-28 Connections between the FPGA and PS/2



Figure 3-29 Y-Cable for using keyboard and mouse simultaneously

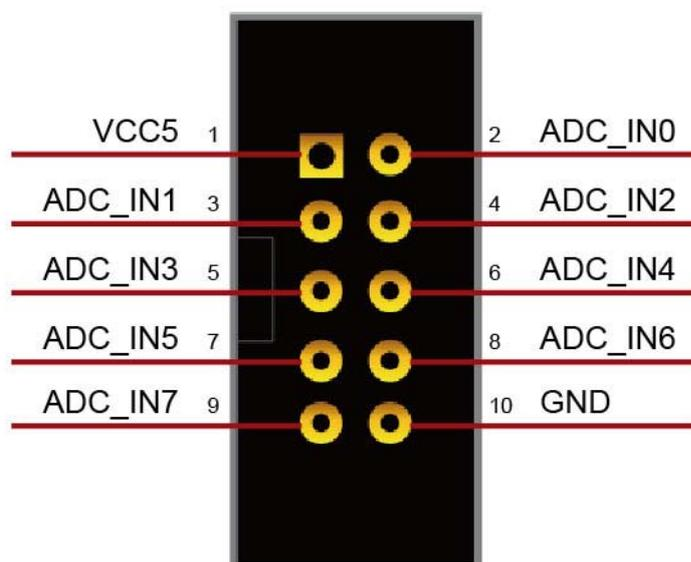
Table 3-21 Pin Assignment of PS/2

Signal Name	FPGA Pin No.	Description	I/O Standard
PS2_CLK	PIN_AD7	PS/2 Clock	3.3V
PS2_DAT	PIN_AE7	PS/2 Data	3.3V
PS2_CLK2	PIN_AD9	PS/2 Clock (reserved for second PS/2 device)	3.3V
PS2_DAT2	PIN_AE9	PS/2 Data (reserved for second PS/2 device)	3.3V

### 3.6.12 A/D Converter and 2x5 Header

The DE1-SoC has an analog-to-digital converter (AD7928), which features lower power, eight-channel CMOS 12-bit. This ADC offers conversion throughput rate up to 1MSPS. The analog input range for all input channels can be 0 V to 2.5 V or 0 V to 5V, depending on the RANGE bit in the control register. It can be configured to accept eight input signals at inputs ADC\_IN0 through ADC\_IN7. These eight input signals are connected to a 2x5 header, as shown in **Figure 3-30**.

More information about the A/D converter chip is available in its datasheet. It can be found on manufacturer's website or in the directory \datasheet of De1-SoC system CD.



**Figure 3-30 Signals of the 2x5 Header**

**Figure 3-31** shows the connections between the FPGA, 2x5 header, and the A/D converter.

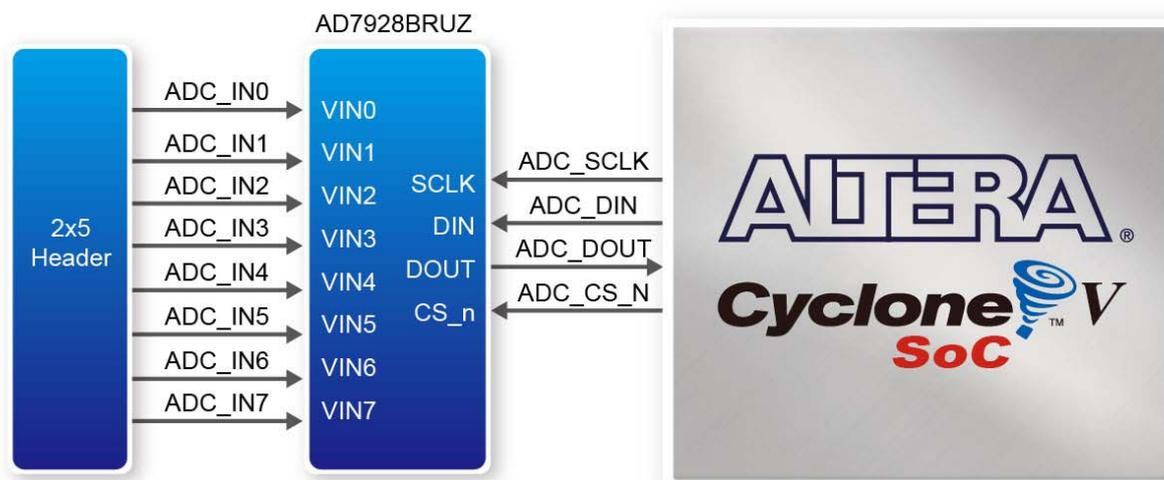


Figure 3-31 Connections between the FPGA, 2x5 header, and the A/D converter

Table 3-22 Pin Assignment of ADC

Signal Name	FPGA Pin No.	Description	I/O Standard
ADC_CS_N	PIN_AJ4	Chip select	3.3V
ADC_DOUT	PIN_AK3	Digital data input	3.3V
ADC_DIN	PIN_AK4	Digital data output	3.3V
ADC_SCLK	PIN_AK2	Digital clock input	3.3V

## 3.7 Peripherals Connected to Hard Processor System (HPS)

This section introduces the interfaces connected to the HPS section of the Cyclone V SoC FPGA. Users can access these interfaces via the HPS processor.

### 3.7.1 User Push-buttons and LEDs

Similar to the FPGA, the HPS also has its set of switches, buttons, LEDs, and other interfaces connected exclusively. Users can control these interfaces to monitor the status of HPS.

Table 3-23 gives the pin assignment of all the LEDs, switches, and push-buttons.

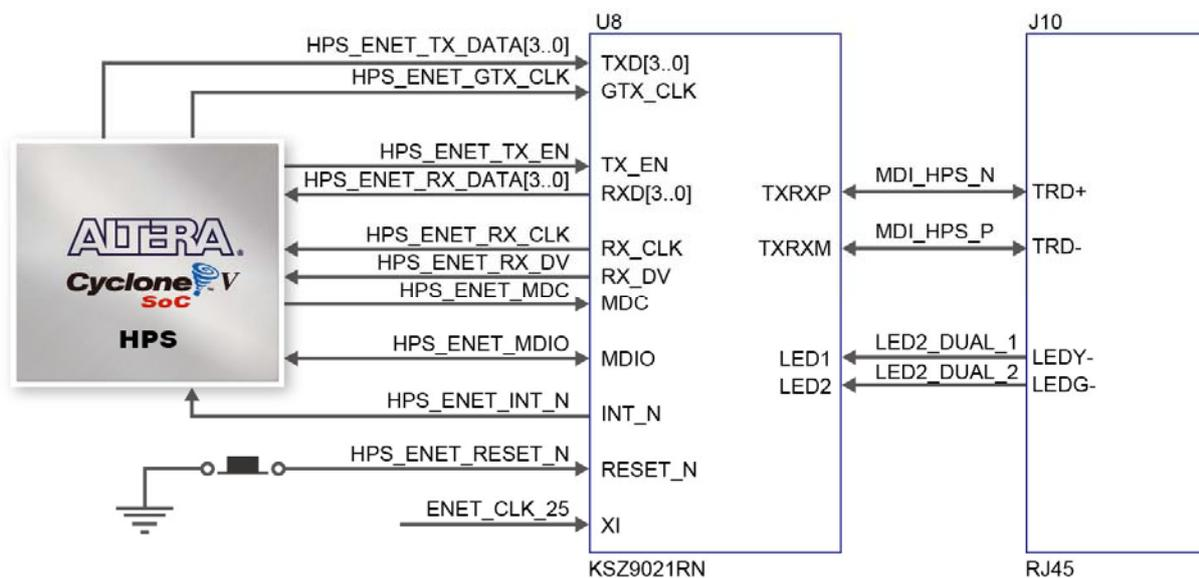
**Table 3-23 Pin Assignment of LEDs, Switches and Push-buttons**

Signal Name	HPS GPIO	Register/bit	Function
HPS_KEY	GPIO54	GPIO1[25]	I/O
HPS_LED	GPIO53	GPIO1[24]	I/O

### 3.7.2 Gigabit Ethernet

The board supports Gigabit Ethernet transfer by an external Micrel KSZ9021RN PHY chip and HPS Ethernet MAC function. The KSZ9021RN chip with integrated 10/100/1000 Mbps Gigabit Ethernet transceiver also supports RGMII MAC interface. **Figure 3-32** shows the connections between the HPS, Gigabit Ethernet PHY, and RJ-45 connector.

The pin assignment associated to Gigabit Ethernet interface is listed in **Table 3-24**. More information about the KSZ9021RN PHY chip and its datasheet, as well as the application notes, which are available on the manufacturer’s website.



**Figure 3-32 Connections between the HPS and Gigabit Ethernet**

**Table 3-24 Pin Assignment of Gigabit Ethernet PHY**

<i>Signal Name</i>	<i>FPGA Pin No.</i>	<i>Description</i>	<i>I/O Standard</i>
HPS_ENET_TX_EN	PIN_A20	GMII and MII transmit enable	3.3V
HPS_ENET_TX_DATA[0]	PIN_F20	MII transmit data[0]	3.3V
HPS_ENET_TX_DATA[1]	PIN_J19	MII transmit data[1]	3.3V
HPS_ENET_TX_DATA[2]	PIN_F21	MII transmit data[2]	3.3V
HPS_ENET_TX_DATA[3]	PIN_F19	MII transmit data[3]	3.3V
HPS_ENET_RX_DV	PIN_K17	GMII and MII receive data valid	3.3V
HPS_ENET_RX_DATA[0]	PIN_A21	GMII and MII receive data[0]	3.3V
HPS_ENET_RX_DATA[1]	PIN_B20	GMII and MII receive data[1]	3.3V
HPS_ENET_RX_DATA[2]	PIN_B18	GMII and MII receive data[2]	3.3V
HPS_ENET_RX_DATA[3]	PIN_D21	GMII and MII receive data[3]	3.3V
HPS_ENET_RX_CLK	PIN_G20	GMII and MII receive clock	3.3V
HPS_ENET_RESET_N	PIN_E18	Hardware Reset Signal	3.3V
HPS_ENET_MDIO	PIN_E21	Management Data	3.3V
HPS_ENET_MDC	PIN_B21	Management Data Clock Reference	3.3V
HPS_ENET_INT_N	PIN_C19	Interrupt Open Drain Output	3.3V
HPS_ENET_GTX_CLK	PIN_H19	GMII Transmit Clock	3.3V

There are two LEDs, green LED (LEDG) and yellow LED (LEDY), which represent the status of Ethernet PHY (KSZ9021RNI). The LED control signals are connected to the LEDs on the RJ45 connector. The state and definition of LEDG and LEDY are listed in [Table 3-25](#). For instance, the connection from board to Gigabit Ethernet is established once the LEDG lights on.

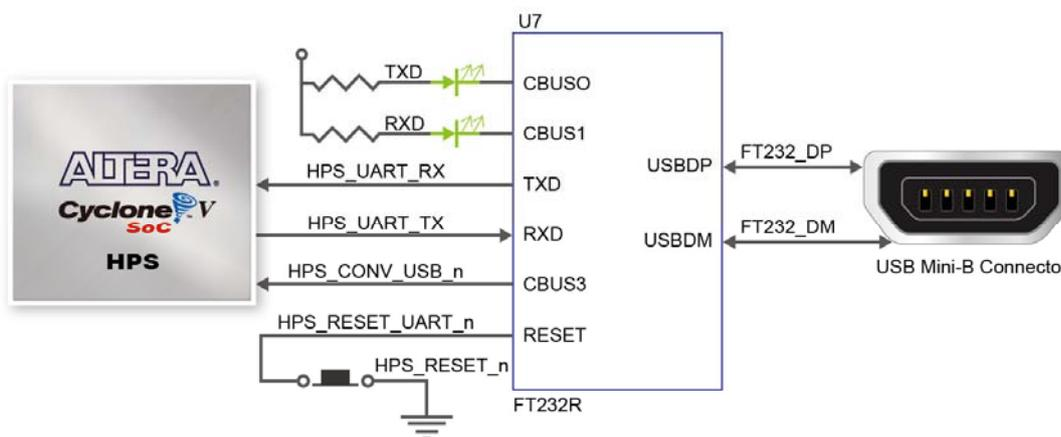
**Table 3-25 State and Definition of LED Mode Pins**

<i>LED (State)</i>		<i>LED (Definition)</i>		<i>Link /Activity</i>
<i>LEDG</i>	<i>LEDY</i>	<i>LEDG</i>	<i>LEDY</i>	
H	H	OFF	OFF	Link off
L	H	ON	OFF	1000 Link / No Activity
Toggle	H	Blinking	OFF	1000 Link / Activity (RX, TX)
H	L	OFF	ON	100 Link / No Activity
H	Toggle	OFF	Blinking	100 Link / Activity (RX, TX)
L	L	ON	ON	10 Link/ No Activity
Toggle	Toggle	Blinking	Blinking	10 Link / Activity (RX, TX)

### 3.7.3 UART

The board has one UART interface connected for communication with the HPS. This interface doesn't support HW flow control signals. The physical interface is implemented by UART-USB onboard bridge from a FT232R chip to the host with an USB Mini-B connector. More information about the chip is available on the manufacturer's website, or in the directory \Datasheets\UART TO

USB of DE1-SoC system CD. **Figure 3-33** shows the connections between the HPS, FT232R chip, and the USB Mini-B connector. **Table 3-26** lists the pin assignment of UART interface connected to the HPS.



**Figure 3-33** Connections between the HPS and FT232R Chip

**Table 3-26** Pin Assignment of UART Interface

Signal Name	FPGA Pin No.	Description	I/O Standard
HPS_UART_RX	PIN_B25	HPS UART Receiver	3.3V
HPS_UART_TX	PIN_C25	HPS UART Transmitter	3.3V
HPS_CONV_USB_N	PIN_B15	Reserve	3.3V

### 3.7.4 DDR3 Memory

The DDR3 devices connected to the HPS are the exact same model as the ones connected to the FPGA. The capacity is 1GB and the data bandwidth is in 32-bit, comprised of two x16 devices with a single address/command bus. The signals are connected to the dedicated Hard Memory Controller for HPS I/O banks and the target speed is 400 MHz. **Table 3-27** lists the pin assignment of DDR3 and its description with I/O standard.

**Table 3-27** Pin Assignment of DDR3 Memory

Signal Name	FPGA Pin No.	Description	I/O Standard
HPS_DDR3_A[0]	PIN_F26	HPS DDR3 Address[0]	SSTL-15 Class I
HPS_DDR3_A[1]	PIN_G30	HPS DDR3 Address[1]	SSTL-15 Class I
HPS_DDR3_A[2]	PIN_F28	HPS DDR3 Address[2]	SSTL-15 Class I
HPS_DDR3_A[3]	PIN_F30	HPS DDR3 Address[3]	SSTL-15 Class I
HPS_DDR3_A[4]	PIN_J25	HPS DDR3 Address[4]	SSTL-15 Class I
HPS_DDR3_A[5]	PIN_J27	HPS DDR3 Address[5]	SSTL-15 Class I

HPS_DDR3_A[6]	PIN_F29	HPS DDR3 Address[6]	SSTL-15 Class I
HPS_DDR3_A[7]	PIN_E28	HPS DDR3 Address[7]	SSTL-15 Class I
HPS_DDR3_A[8]	PIN_H27	HPS DDR3 Address[8]	SSTL-15 Class I
HPS_DDR3_A[9]	PIN_G26	HPS DDR3 Address[9]	SSTL-15 Class I
HPS_DDR3_A[10]	PIN_D29	HPS DDR3 Address[10]	SSTL-15 Class I
HPS_DDR3_A[11]	PIN_C30	HPS DDR3 Address[11]	SSTL-15 Class I
HPS_DDR3_A[12]	PIN_B30	HPS DDR3 Address[12]	SSTL-15 Class I
HPS_DDR3_A[13]	PIN_C29	HPS DDR3 Address[13]	SSTL-15 Class I
HPS_DDR3_A[14]	PIN_H25	HPS DDR3 Address[14]	SSTL-15 Class I
HPS_DDR3_BA[0]	PIN_E29	HPS DDR3 Bank Address[0]	SSTL-15 Class I
HPS_DDR3_BA[1]	PIN_J24	HPS DDR3 Bank Address[1]	SSTL-15 Class I
HPS_DDR3_BA[2]	PIN_J23	HPS DDR3 Bank Address[2]	SSTL-15 Class I
HPS_DDR3_CAS_n	PIN_E27	DDR3 Column Address Strobe	SSTL-15 Class I
HPS_DDR3_CKE	PIN_L29	HPS DDR3 Clock Enable	SSTL-15 Class I
HPS_DDR3_CK_n	PIN_L23	HPS DDR3 Clock	Differential 1.5-V SSTL Class I
HPS_DDR3_CK_p	PIN_M23	HPS DDR3 Clock p	Differential 1.5-V SSTL Class I
HPS_DDR3_CS_n	PIN_H24	HPS DDR3 Chip Select	SSTL-15 Class I
HPS_DDR3_DM[0]	PIN_K28	HPS DDR3 Data Mask[0]	SSTL-15 Class I
HPS_DDR3_DM[1]	PIN_M28	HPS DDR3 Data Mask[1]	SSTL-15 Class I
HPS_DDR3_DM[2]	PIN_R28	HPS DDR3 Data Mask[2]	SSTL-15 Class I
HPS_DDR3_DM[3]	PIN_W30	HPS DDR3 Data Mask[3]	SSTL-15 Class I
HPS_DDR3_DQ[0]	PIN_K23	HPS DDR3 Data[0]	SSTL-15 Class I
HPS_DDR3_DQ[1]	PIN_K22	HPS DDR3 Data[1]	SSTL-15 Class I
HPS_DDR3_DQ[2]	PIN_H30	HPS DDR3 Data[2]	SSTL-15 Class I
HPS_DDR3_DQ[3]	PIN_G28	HPS DDR3 Data[3]	SSTL-15 Class I
HPS_DDR3_DQ[4]	PIN_L25	HPS DDR3 Data[4]	SSTL-15 Class I
HPS_DDR3_DQ[5]	PIN_L24	HPS DDR3 Data[5]	SSTL-15 Class I
HPS_DDR3_DQ[6]	PIN_J30	HPS DDR3 Data[6]	SSTL-15 Class I
HPS_DDR3_DQ[7]	PIN_J29	HPS DDR3 Data[7]	SSTL-15 Class I
HPS_DDR3_DQ[8]	PIN_K26	HPS DDR3 Data[8]	SSTL-15 Class I
HPS_DDR3_DQ[9]	PIN_L26	HPS DDR3 Data[9]	SSTL-15 Class I
HPS_DDR3_DQ[10]	PIN_K29	HPS DDR3 Data[10]	SSTL-15 Class I
HPS_DDR3_DQ[11]	PIN_K27	HPS DDR3 Data[11]	SSTL-15 Class I
HPS_DDR3_DQ[12]	PIN_M26	HPS DDR3 Data[12]	SSTL-15 Class I
HPS_DDR3_DQ[13]	PIN_M27	HPS DDR3 Data[13]	SSTL-15 Class I
HPS_DDR3_DQ[14]	PIN_L28	HPS DDR3 Data[14]	SSTL-15 Class I
HPS_DDR3_DQ[15]	PIN_M30	HPS DDR3 Data[15]	SSTL-15 Class I
HPS_DDR3_DQ[16]	PIN_U26	HPS DDR3 Data[16]	SSTL-15 Class I
HPS_DDR3_DQ[17]	PIN_T26	HPS DDR3 Data[17]	SSTL-15 Class I
HPS_DDR3_DQ[18]	PIN_N29	HPS DDR3 Data[18]	SSTL-15 Class I
HPS_DDR3_DQ[19]	PIN_N28	HPS DDR3 Data[19]	SSTL-15 Class I
HPS_DDR3_DQ[20]	PIN_P26	HPS DDR3 Data[20]	SSTL-15 Class I
HPS_DDR3_DQ[21]	PIN_P27	HPS DDR3 Data[21]	SSTL-15 Class I
HPS_DDR3_DQ[22]	PIN_N27	HPS DDR3 Data[22]	SSTL-15 Class I



HPS_DDR3_DQ[23]	PIN_R29	HPS DDR3 Data[23]	SSTL-15 Class I
HPS_DDR3_DQ[24]	PIN_P24	HPS DDR3 Data[24]	SSTL-15 Class I
HPS_DDR3_DQ[25]	PIN_P25	HPS DDR3 Data[25]	SSTL-15 Class I
HPS_DDR3_DQ[26]	PIN_T29	HPS DDR3 Data[26]	SSTL-15 Class I
HPS_DDR3_DQ[27]	PIN_T28	HPS DDR3 Data[27]	SSTL-15 Class I
HPS_DDR3_DQ[28]	PIN_R27	HPS DDR3 Data[28]	SSTL-15 Class I
HPS_DDR3_DQ[29]	PIN_R26	HPS DDR3 Data[29]	SSTL-15 Class I
HPS_DDR3_DQ[30]	PIN_V30	HPS DDR3 Data[30]	SSTL-15 Class I
HPS_DDR3_DQ[31]	PIN_W29	HPS DDR3 Data[31]	SSTL-15 Class I
HPS_DDR3_DQS_n[0]	PIN_M19	HPS DDR3 Data Strobe n[0]	Differential 1.5-V SSTL Class I
HPS_DDR3_DQS_n[1]	PIN_N24	HPS DDR3 Data Strobe n[1]	Differential 1.5-V SSTL Class I
HPS_DDR3_DQS_n[2]	PIN_R18	HPS DDR3 Data Strobe n[2]	Differential 1.5-V SSTL Class I
HPS_DDR3_DQS_n[3]	PIN_R21	HPS DDR3 Data Strobe n[3]	Differential 1.5-V SSTL Class I
HPS_DDR3_DQS_p[0]	PIN_N18	HPS DDR3 Data Strobe p[0]	Differential 1.5-V SSTL Class I
HPS_DDR3_DQS_p[1]	PIN_N25	HPS DDR3 Data Strobe p[1]	Differential 1.5-V SSTL Class I
HPS_DDR3_DQS_p[2]	PIN_R19	HPS DDR3 Data Strobe p[2]	Differential 1.5-V SSTL Class I
HPS_DDR3_DQS_p[3]	PIN_R22	HPS DDR3 Data Strobe p[3]	Differential 1.5-V SSTL Class I
HPS_DDR3_ODT	PIN_H28	HPS DDR3 On-die Termination	SSTL-15 Class I
HPS_DDR3_RAS_n	PIN_D30	DDR3 Row Address Strobe	SSTL-15 Class I
HPS_DDR3_RESET_n	PIN_P30	HPS DDR3 Reset	SSTL-15 Class I
HPS_DDR3_WE_n	PIN_C28	HPS DDR3 Write Enable	SSTL-15 Class I
HPS_DDR3_RZQ	PIN_D27	External reference ball for output drive calibration	1.5 V

### 3.7.5 Micro SD Card Socket

The board supports Micro SD card interface with x4 data lines. It serves not only an external storage for the HPS, but also an alternative boot option for DE1-SoC board. **Figure 3-34** shows signals connected between the HPS and Micro SD card socket.

**Table 3-28** lists the pin assignment of Micro SD card socket to the HPS.

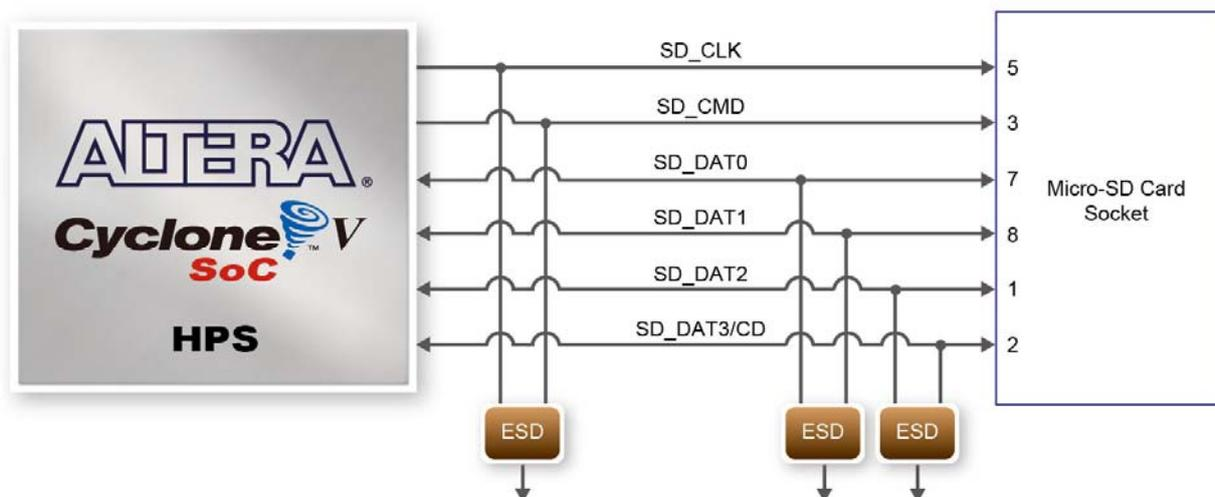


Figure 3-34 Connections between the FPGA and SD card socket

Table 3-28 Pin Assignment of Micro SD Card Socket

Signal Name	FPGA Pin No.	Description	I/O Standard
HPS_SD_CLK	PIN_A16	HPS SD Clock	3.3V
HPS_SD_CMD	PIN_F18	HPS SD Command Line	3.3V
HPS_SD_DATA[0]	PIN_G18	HPS SD Data[0]	3.3V
HPS_SD_DATA[1]	PIN_C17	HPS SD Data[1]	3.3V
HPS_SD_DATA[2]	PIN_D17	HPS SD Data[2]	3.3V
HPS_SD_DATA[3]	PIN_B16	HPS SD Data[3]	3.3V

### 3.7.6 2-port USB Host

The board has two USB 2.0 type-A ports with a SMSC USB3300 controller and a 2-port hub controller. The SMSC USB3300 device in 32-pin QFN package interfaces with the SMSC USB2512B hub controller. This device supports UTMI+ Low Pin Interface (ULPI), which communicates with the USB 2.0 controller in HPS. The PHY operates in Host mode by connecting the ID pin of USB3300 to ground. When operating in Host mode, the device is powered by the two USB type-A ports. **Figure 3-35** shows the connections of USB PTG PHY to the HPS. **Table 3-29** lists the pin assignment of USBOTG PHY to the HPS.

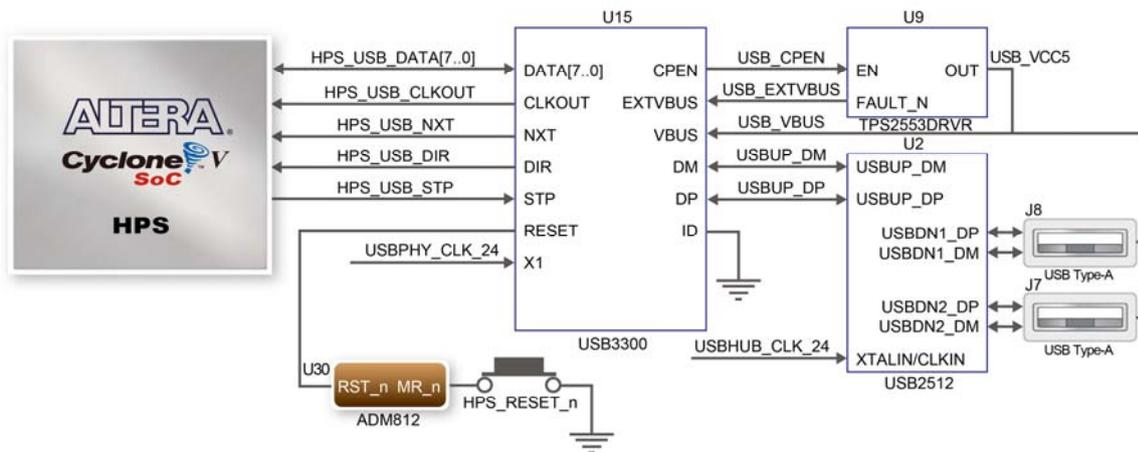


Figure 3-35 Connections between the HPS and USB OTG PHY

Table 3-29 Pin Assignment of USB OTG PHY

Signal Name	FPGA Pin No.	Description	I/O Standard
HPS_USB_CLKOUT	PIN_N16	60MHz Reference Clock Output	3.3V
HPS_USB_DATA[0]	PIN_E16	HPS USB_DATA[0]	3.3V
HPS_USB_DATA[1]	PIN_G16	HPS USB_DATA[1]	3.3V
HPS_USB_DATA[2]	PIN_D16	HPS USB_DATA[2]	3.3V
HPS_USB_DATA[3]	PIN_D14	HPS USB_DATA[3]	3.3V
HPS_USB_DATA[4]	PIN_A15	HPS USB_DATA[4]	3.3V
HPS_USB_DATA[5]	PIN_C14	HPS USB_DATA[5]	3.3V
HPS_USB_DATA[6]	PIN_D15	HPS USB_DATA[6]	3.3V
HPS_USB_DATA[7]	PIN_M17	HPS USB_DATA[7]	3.3V
HPS_USB_DIR	PIN_E14	Direction of the Data Bus	3.3V
HPS_USB_NXT	PIN_A14	Throttle the Data	3.3V
HPS_USB_RESET	PIN_G17	HPS USB PHY Reset	3.3V
HPS_USB_STP	PIN_C15	Stop Data Stream on the Bus	3.3V

### 3.7.7 G-sensor

The board comes with a digital accelerometer sensor module (ADXL345), commonly known as G-sensor. This G-sensor is a small, thin, ultralow power assumption 3-axis accelerometer with high-resolution measurement. Digitalized output is formatted as 16-bit in two's complement and can be accessed through I2C interface. The I2C address of G-sensor is 0xA6/0xA7. More information about this chip can be found in its datasheet, which is available on manufacturer's website or in the directory \Datasheet folder of DE1-SoC system CD. **Figure 3-36** shows the connections between the HPS and G-sensor. **Table 3-30** lists the pin assignment of G-sensor to the HPS.

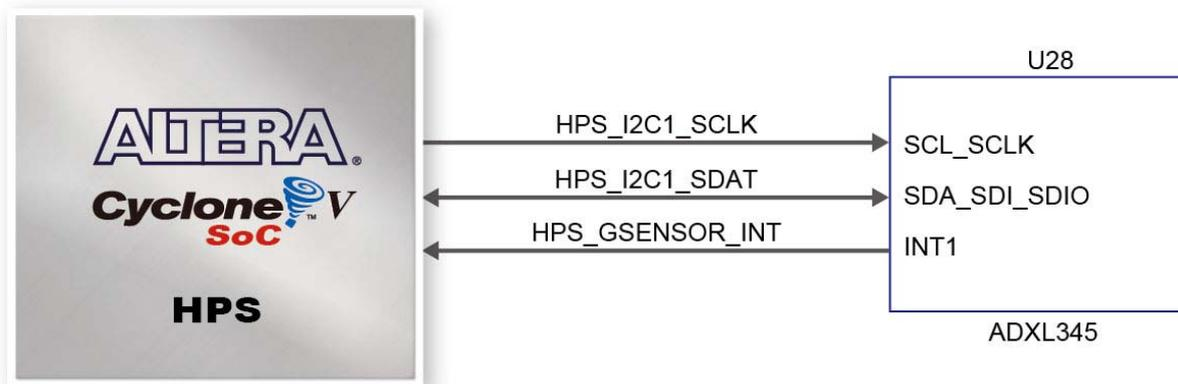


Figure 3-36 Connections between Cyclone V SoC FPGA and G-Sensor

Table 3-30 Pin Assignment of G-sensor

Signal Name	FPGA Pin No.	Description	I/O Standard
HPS_GSENSOR_INT	PIN_B22	HPS GSENSOR Interrupt Output	3.3V
HPS_I2C1_SCLK	PIN_E23	HPS I2C Clock (share bus with LTC)	3.3V
HPS_I2C1_SDAT	PIN_C24	HPS I2C Data (share bus)	3.3V

### 3.7.8 LTC Connector

The board has a 14-pin header, which is originally used to communicate with various daughter cards from Linear Technology. It is connected to the SPI Master and I2C ports of HPS. The communication with these two protocols is bi-directional. The 14-pin header can also be used for GPIO, SPI, or I2C based communication with the HPS. Connections between the HPS and LTC connector are shown in [Figure 3-37](#), and the pin assignment of LTC connector is listed in [Table 3-31](#).

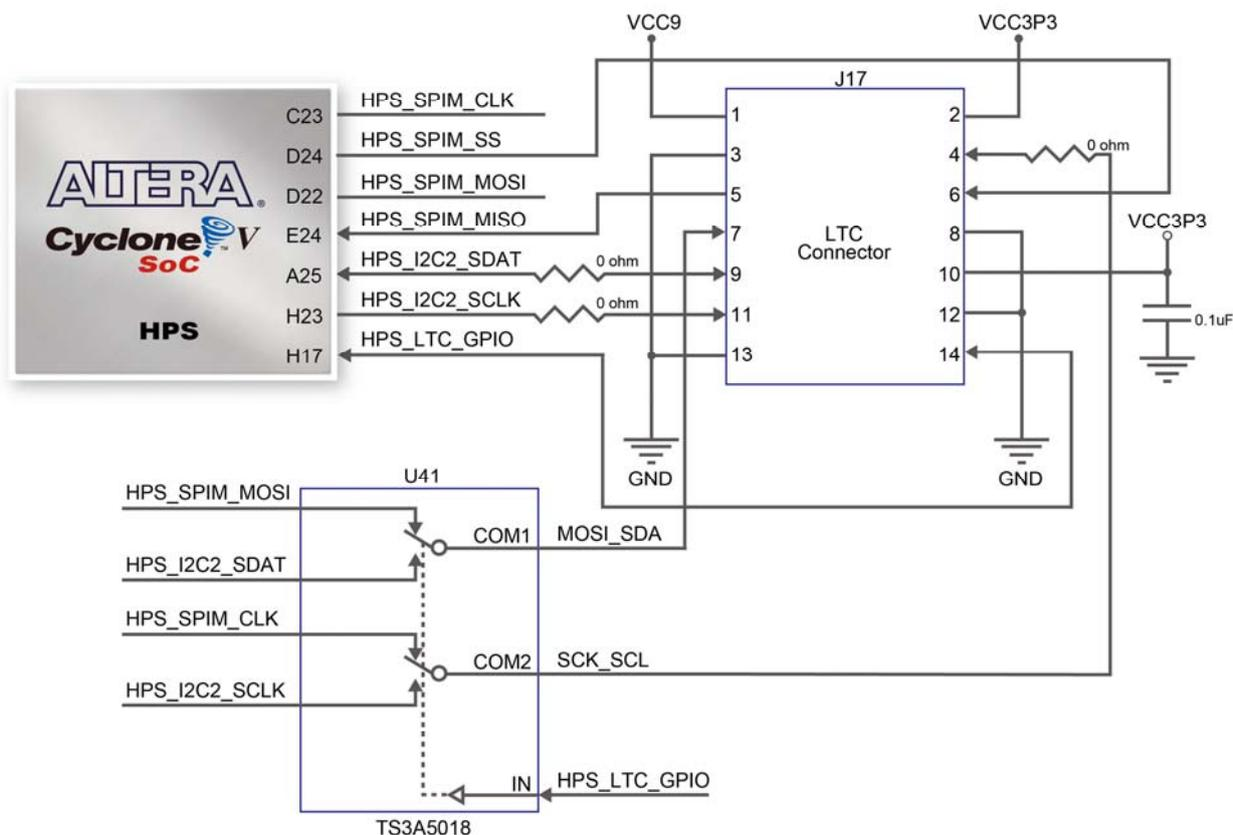


Figure 3-37 Connections between the HPS and LTC connector

Table 3-31 Pin Assignment of LTC Connector

Signal Name	FPGA Pin No.	Description	I/O Standard
HPS_LTC_GPIO	PIN_H17	HPS LTC GPIO	3.3V
HPS_I2C2_SCLK	PIN_H23	HPS I2C2 Clock (share bus with G-Sensor)	3.3V
HPS_I2C2_SDAT	PIN_A25	HPS I2C2 Data (share bus with G-Sensor)	3.3V
HPS_SPIM_CLK	PIN_C23	SPI Clock	3.3V
HPS_SPIM_MISO	PIN_E24	SPI Master Input/Slave Output	3.3V
HPS_SPIM_MOSI	PIN_D22	SPI Master Output /Slave Input	3.3V
HPS_SPIM_SS	PIN_D24	SPI Slave Select	3.3V

## Chapter 4

# *DE1-SoC System Builder*

---

This chapter describes how users can create a custom design project with the tool named DE1-SoC System Builder.

### 4.1 Introduction

The DE1-SoC System Builder is a Windows-based utility. It is designed to help users create a Quartus II project for DE1-SoC within minutes. The generated Quartus II project files include:

- Quartus II project file (.qpf)
- Quartus II setting file (.qsf)
- Top-level design file (.v)
- Synopsis design constraints file (.sdc)
- Pin assignment document (.htm)

The above files generated by the DE1-SoC System Builder can also prevent occurrence of situations that are prone to compilation error when users manually edit the top-level design file or place pin assignment. The common mistakes that users encounter are:

- Board is damaged due to incorrect bank voltage setting or pin assignment.
- Board is malfunctioned because of wrong device chosen, declaration of pin location or direction is incorrect or forgotten.
- Performance degradation due to improper pin assignment.

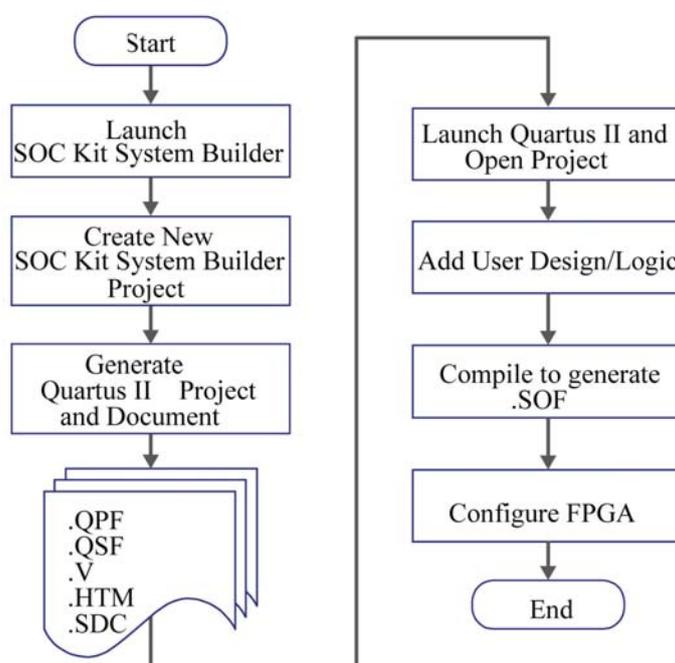
### 4.2 Design Flow

This section provides an introduction to the design flow of building a Quartus II project for DE1-SoC under the DE1-SoC System Builder. The design flow is illustrated in **Figure 4-1**.

The DE1-SoC System Builder will generate two major files, a top-level design file (.v) and a Quartus II setting file (.qsf) after users launch the DE1-SoC System Builder and create a new project according to their design requirements

The top-level design file contains a top-level Verilog HDL wrapper for users to add their own design/logic. The Quartus II setting file contains information such as FPGA device type, top-level pin assignment, and the I/O standard for each user-defined I/O pin.

Finally, the Quartus II programmer is used to download .sof file to the development board via JTAG interface.



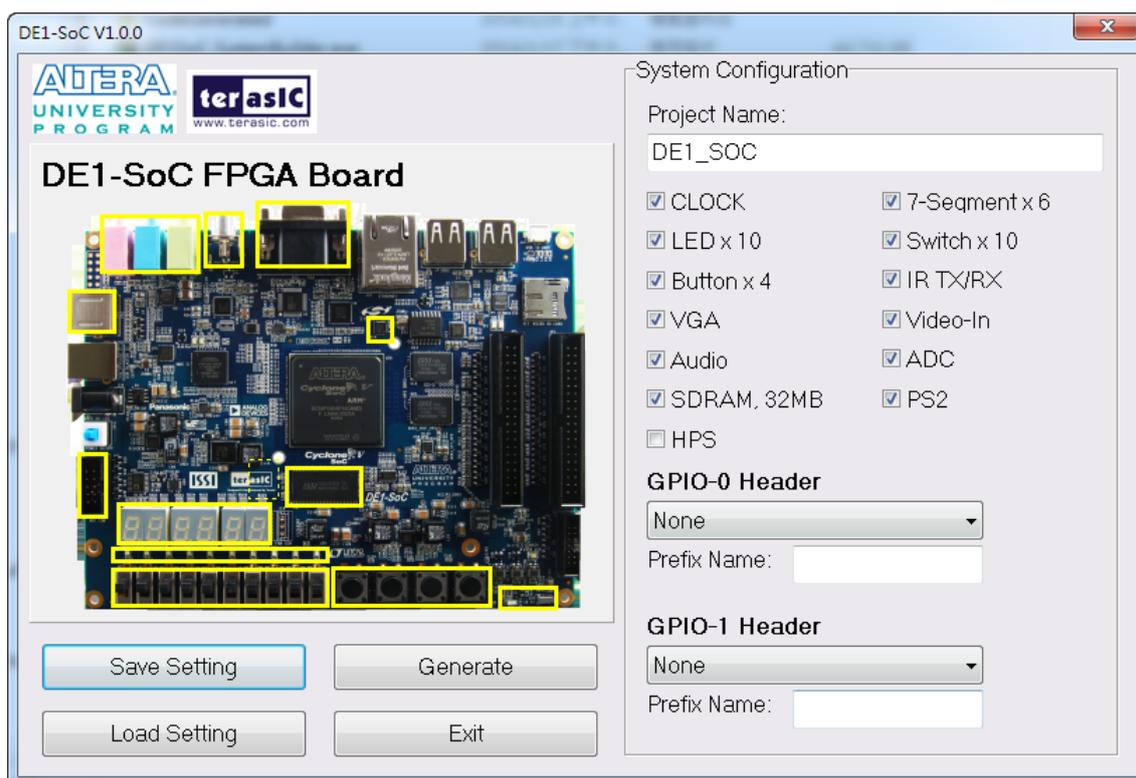
**Figure 4-1 Design flow of building a project from the beginning to the end**

### 4.3 Using DE1-SoC System Builder

This section provides the procedures in details on how to use the DE1-SoC System Builder.

## ■ Install and Launch the DE1-SoC System Builder

The DE1-SoC System Builder is located in the directory: “Tools\SystemBuilder” of the DE1-SoC System CD. Users can copy the entire folder to a host computer without installing the utility. A window will pop up, as shown in **Figure 4-2**, after executing the DE1-SoC SystemBuilder.exe on the host computer.



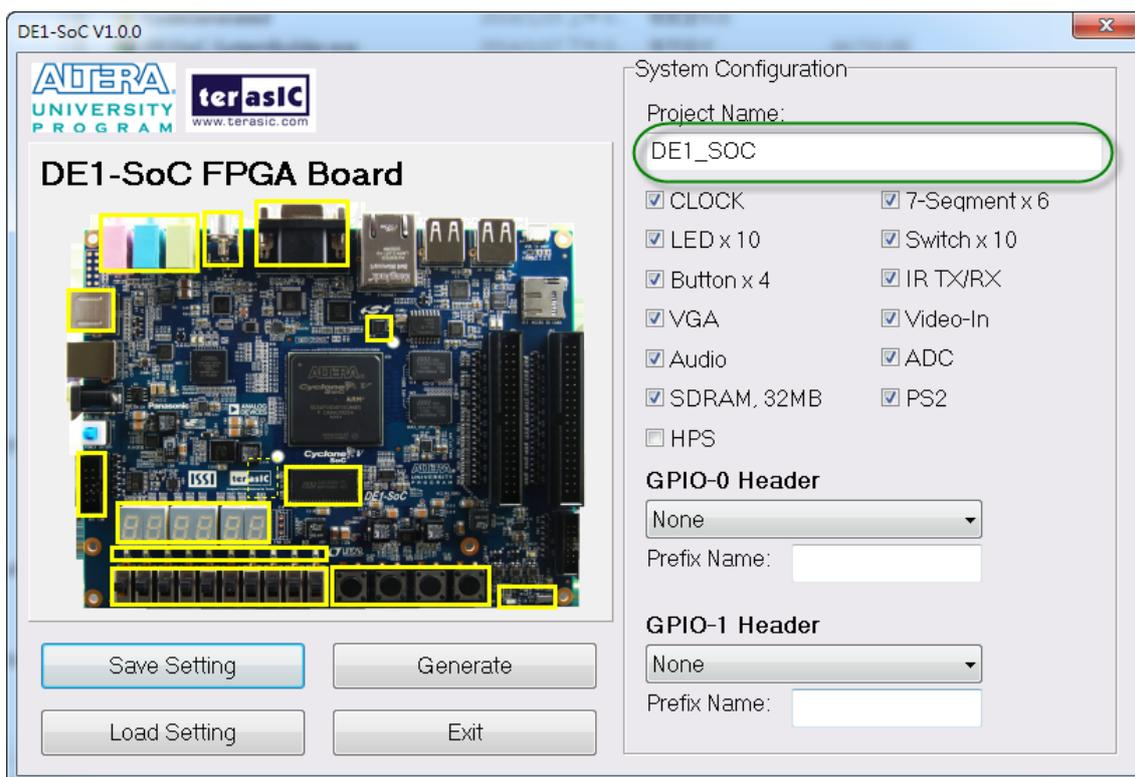
**Figure 4-2 The GUI of DE1-SoC System Builder**

## ■ Enter Project Name

Enter the project name in the circled area, as shown in **Figure 4-3**.

The project name typed in will be assigned automatically as the name of your top-level design entity.

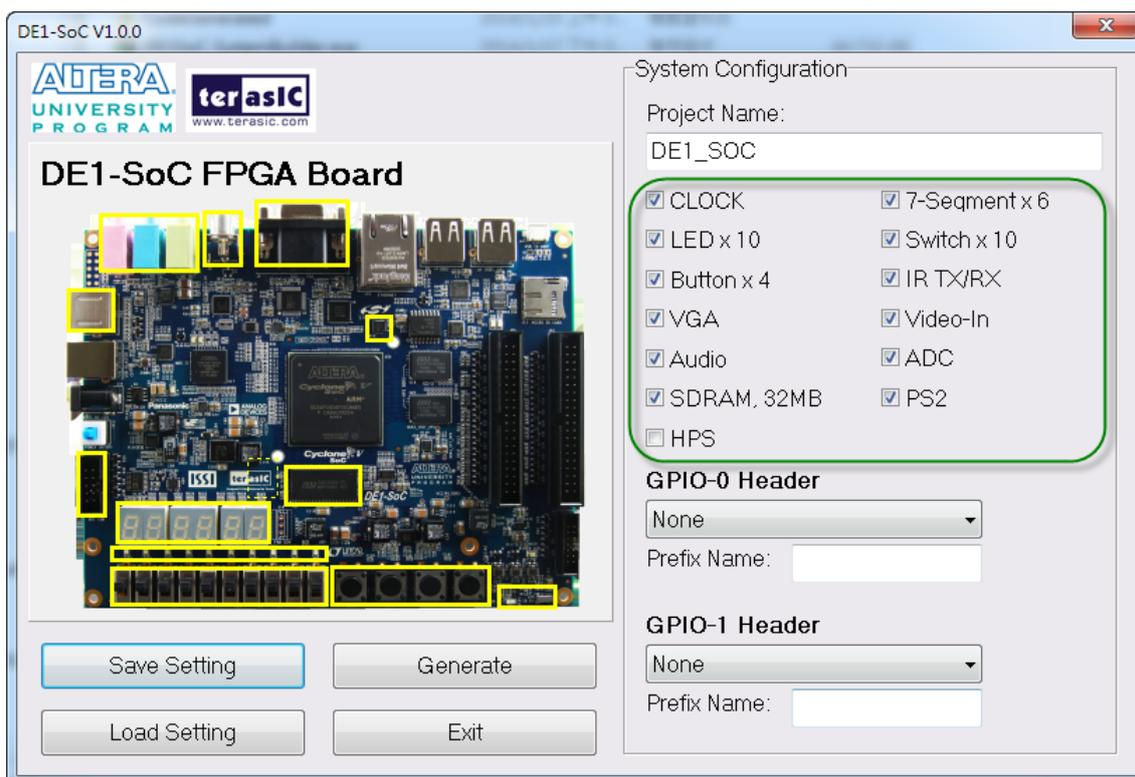




**Figure 4-3 Enter the project name**

## ■ System Configuration

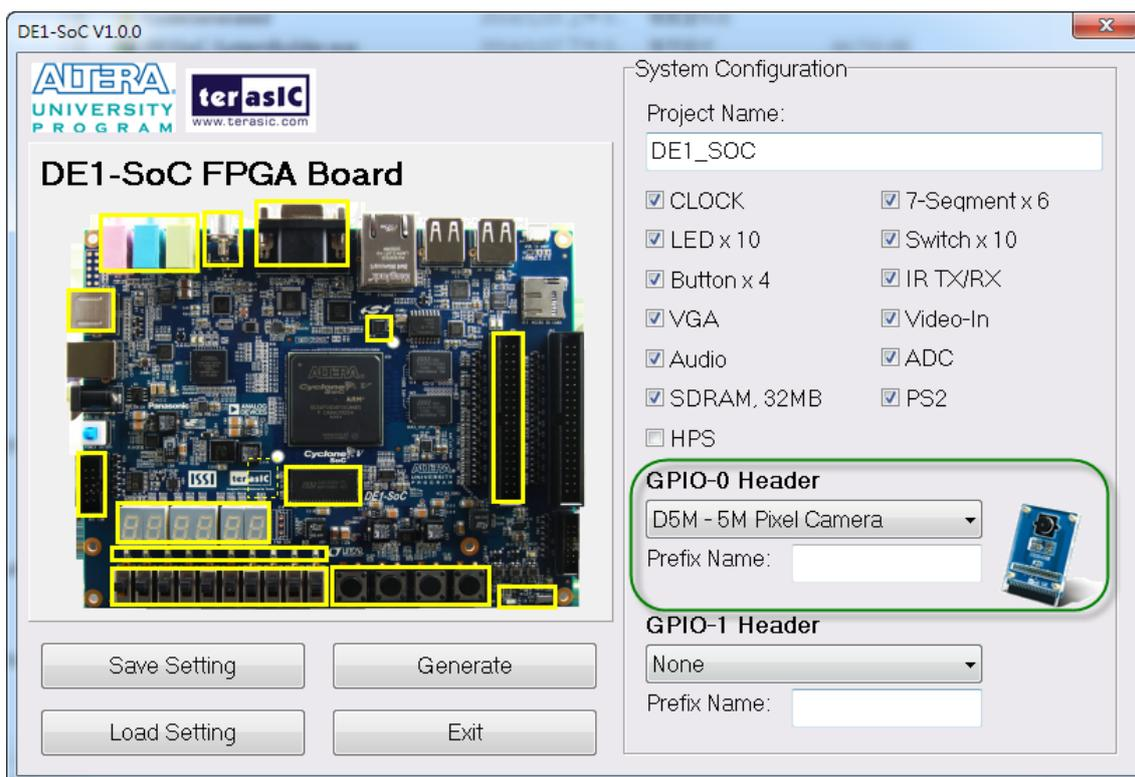
Users are given the flexibility in the System Configuration to include their choice of components in the project, as shown in **Figure 4-4**. Each component onboard is listed and users can enable or disable one or more components at will. If a component is enabled, the DE1-SoC System Builder will automatically generate its associated pin assignment, including the pin name, pin location, pin direction, and I/O standard.



**Figure 4-4 System configuration group**

## ■ GPIO Expansion

If users connect any Terasic GPIO-based daughter card to the GPIO connector(s) on DE1-SoC, the DE1-SoC System Builder can generate a project that include the corresponding module, as shown in **Figure 4-5**. It will also generate the associated pin assignment automatically, including pin name, pin location, pin direction, and I/O standard.



**Figure 4-5 GPIO expansion group**

The “Prefix Name” is an optional feature that denote the pin name of the daughter card assigned in your design. Users may leave this field blank.

## ■ Project Setting Management

The DE1-SoC System Builder also provides the option to load a setting or save users’ current board configuration in .cfg file, as shown in **Figure 4-6**.

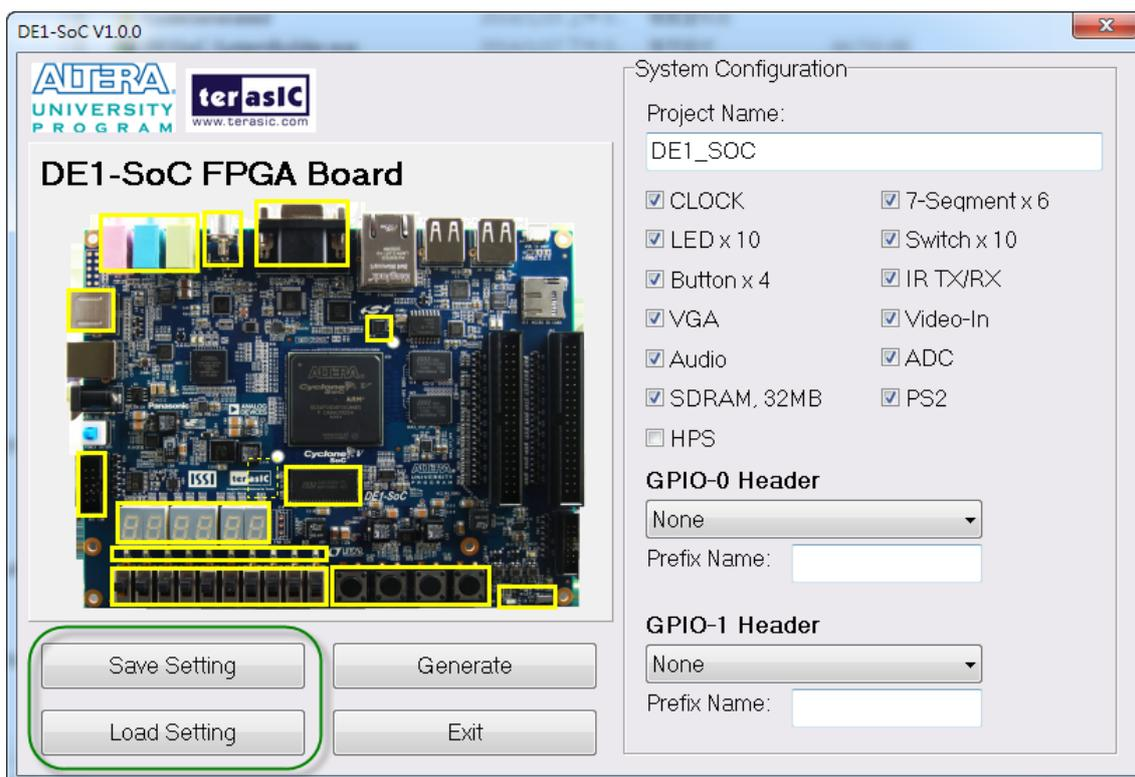


Figure 4-6 Project Settings

## ■ Project Generation

When users press the *Generate* button, the DE1-SoC System Builder will generate the corresponding Quartus II files and documents, as listed in **Table 4-1**:

**Table 4-1 Files generated by the DE1-SoC System Builder**

No.	Filename	Description
1	<Project name>.v	Top level Verilog HDL file for Quartus II
2	<Project name>.qpf	Quartus II Project File
3	<Project name>.qsf	Quartus II Setting File
4	<Project name>.sdc	Synopsis Design Constraints file for Quartus II
5	<Project name>.htm	Pin Assignment Document

Users can add custom logic into the project in Quartus II and compile the project to generate the SRAM Object File (.sof).

# Examples For FPGA

---

This chapter provides examples of advanced designs implemented by RTL or Qsys on the DE1-SoC board. These reference designs cover the features of peripherals connected to the FPGA, such as audio, SDRAM, and IR receiver. All the associated files can be found in the directory \Demonstrations\FPGA of DE1-SoC System CD.

### ■ Installation of Demonstrations

To install the demonstrations on your computer:

Copy the folder Demonstrations to a local directory of your choice. It is important to make sure the path to your local directory contains NO space. Otherwise it will lead to error in Nios II. **Note** Quartus II v13.0 or later is required for all DE1-SoC demonstrations to support Cyclone V SoC device.

## 5.1 DE1-SoC Factory Configuration

The DE1-SoC board has a default configuration bit-stream pre-programmed, which demonstrates some of the basic features onboard. The setup required for this demonstration and the location of its files are shown below.

### ■ Demonstration Setup, File Locations, and Instructions

- Project directory: DE1\_SoC\_Default
- Bitstream used: DE1\_SoC\_Default.sof or DE1\_SoC\_Default.jic
- Power on the DE1-SoC board with the USB cable connected to the USB-Blaster II port. If necessary (that is, if the default factory configuration is not currently stored in the EPCQ device), download the bit stream to the board via JTAG interface.
- You should now be able to observe the 7-segment displays are showing a sequence of characters, and the red LEDs are blinking.

- If the VGA D-SUB connector is connected to a VGA display, it would show a color picture.
- If the stereo line-out jack is connected to a speaker and KEY[1] is pressed, a 1 kHz humming sound will come out of the line-out port .
- For the ease of execution, a demo\_batch folder is provided in the project. It is able to not only load the bit stream into the FPGA in command line, but also program or erase .jic file to the EPCQ by executing the test.bat file shown in **Figure 5-1**.

If users want to program a new design into the EPCQ device, the easiest method is to copy the new .sof file into the demo\_batch folder and execute the test.bat. Option “2” will convert the .sof to .jic and option”3” will program .jic file into the EPCQ device.

```

*****
Plesase choise your operation
"1" for programming .sof to FPGA.
"2" for converting .sof to .jic
"3" for programming .jic to EPCQ.
"4" for erasing .jic from EPCQ.
*****
Please enter your choise: [1,2,3,4]?

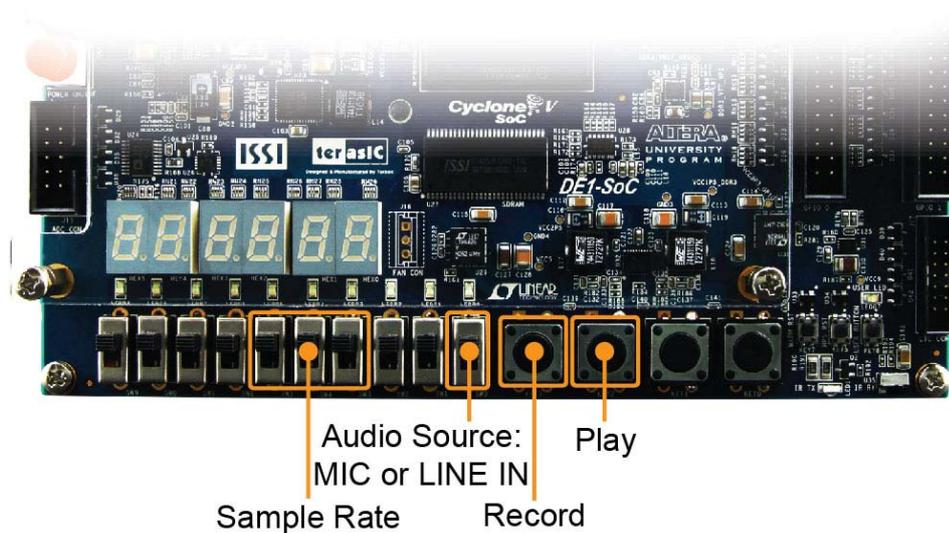
```

**Figure 5-1** Command line of the batch file to program the FPGA and EPCQ device

## 5.2 Audio Recording and Playing

This demonstration shows how to implement an audio recorder and player on DE1-SoC board with the built-in audio CODEC chip. It is developed based on Qsys and Eclipse. **Figure 5-2** shows the buttons and slide switches used to interact this demonstration onboard. Users can configure this audio system through two push-buttons and four slide switches:

- SW0 is used to specify the recording source to be Line-in or MIC-In.
- SW1, SW2, and SW3 are used to specify the recording sample rate such as 96K, 48K, 44.1K, 32K, or 8K.
- **Table 5-1** and **Table 5-2** summarize the usage of slide switches for configuring the audio recorder and player.



**Figure 5-2 Buttons and switches for the audio recorder and player**

**Figure 5-3** shows the block diagram of audio recorder and player design. There are hardware and software parts in the block diagram. The software part stores the Nios II program in the on-chip memory. The software part is built under Eclipse in C programming language. The hardware part is built under Qsys in Quartus II. The hardware part includes all the other blocks such as the “AUDIO Controller”, which is a user-defined Qsys component and it is designed to send audio data to the audio chip or receive audio data from the audio chip.

The audio chip is programmed through I2C protocol, which is implemented in C code. The I2C pins from the audio chip are connected to Qsys system interconnect fabric through PIO controllers. The audio chip is configured in master mode in this demonstration. The audio interface is configured as 16-bit I2S mode. 18.432MHz clock generated by the PLL is connected to the MCLK/XTI pin of the audio chip through the audio controller.

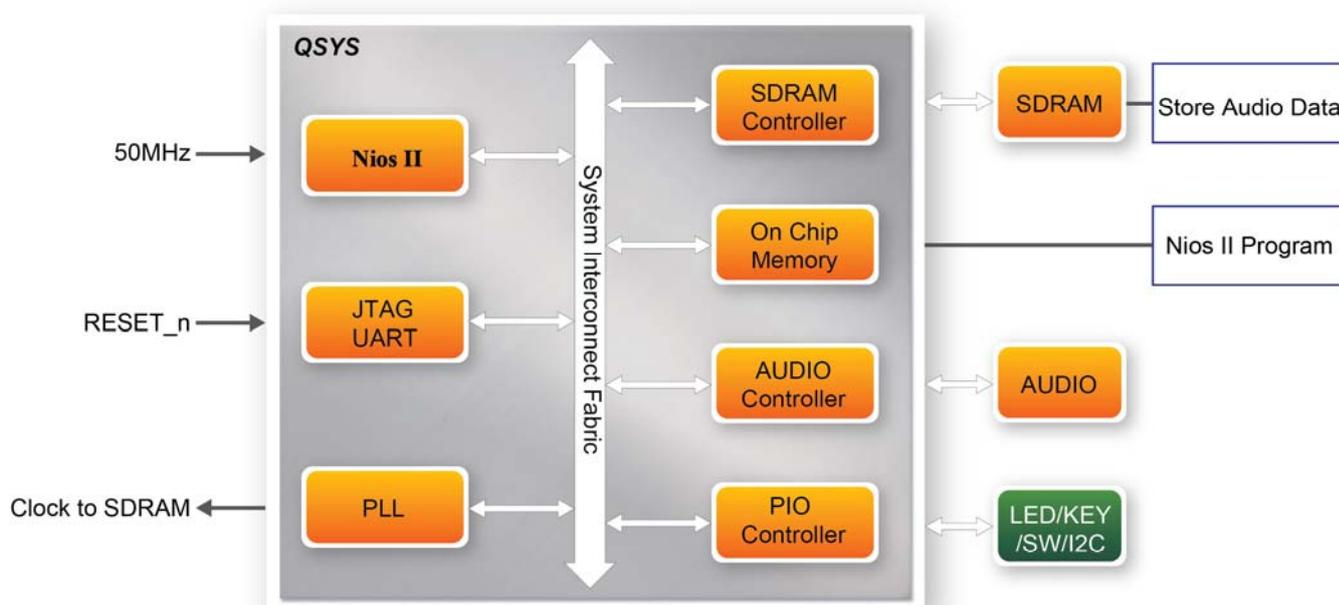


Figure 5-3 Block diagram of the audio recorder and player

## ■ Demonstration Setup, File Locations, and Instructions

- Hardware project directory: DE1\_SoC\_Audio
- Bitstream used: DE1\_SoC\_Audio.sof
- Software project directory: DE1\_SoC\_Audio\software
- Connect an audio source to the Line-in port
- Connect a Microphone to the MIC-in port
- Connect a speaker or headset to the Line-out port
- Load the bitstream into the FPGA. (note \*1)
- Load the software execution file into the FPGA. (note \*1)
- Configure the audio with SW0, as shown in **Table 5-1**.
- Press KEY3 to start/stop audio recording (note \*2)
- Press KEY2 to start/stop audio playing (note \*3)

**Table 5-1 Slide switches usage for audio source**

Slide Switches	0 – DOWN Position	1 – UP Position
SW0	Audio is from MIC-in	Audio is from Line-in



**Table 5-2 Settings of switches for the sample rate of audio recorder and player**

<b>SW5</b> (0 – DOWN; 1- UP)	<b>SW4</b> (0 – DOWN; 1-UP)	<b>SW3</b> (0 – DOWN; 1-UP)	<b>Sample Rate</b>
0	0	0	96K
0	0	1	48K
0	1	0	44.1K
0	1	1	32K
1	0	0	8K
<b>Unlisted combination</b>			<b>96K</b>



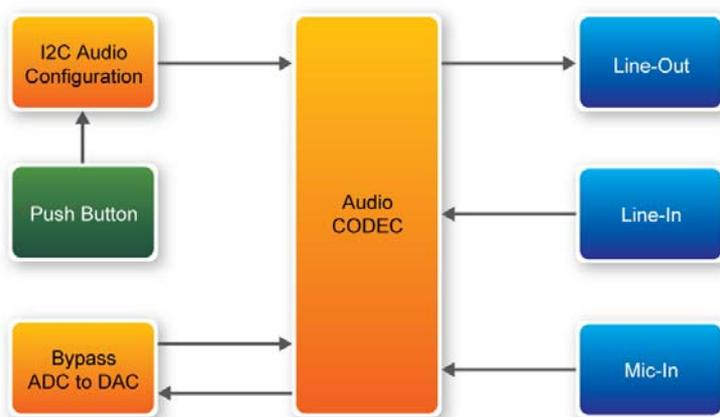
*Note:*

- (1). Execute `DE1_SoC_Audio \demo_batch\ DE1-SoC_Audio.bat` to download `.sof` and `.elf` files.
- (2). Recording process will stop if the audio buffer is full.
- (3). Playing process will stop if the audio data is played completely.

## 5.3 Karaoke Machine

This demonstration uses the microphone-in, line-in, and line-out ports on DE1-SoC to create a Karaoke machine. The WM8731 CODEC is configured in master mode. The audio CODEC generates AD/DA serial bit clock (BCK) and the left/right channel clock (LRCK) automatically. The I2C interface is used to configure the audio CODEC, as shown in **Figure 5-4**. The sample rate and gain of the CODEC are set in a similar manner, and the data input from the line-in port is then mixed with the microphone-in port. The result is sent out to the line-out port.

The sample rate is set to 48 kHz in this demonstration. The gain of the audio CODEC is reconfigured via I2C bus by pressing the pushbutton KEY0, cycling within ten predefined gain values (volume levels) provided by the device.

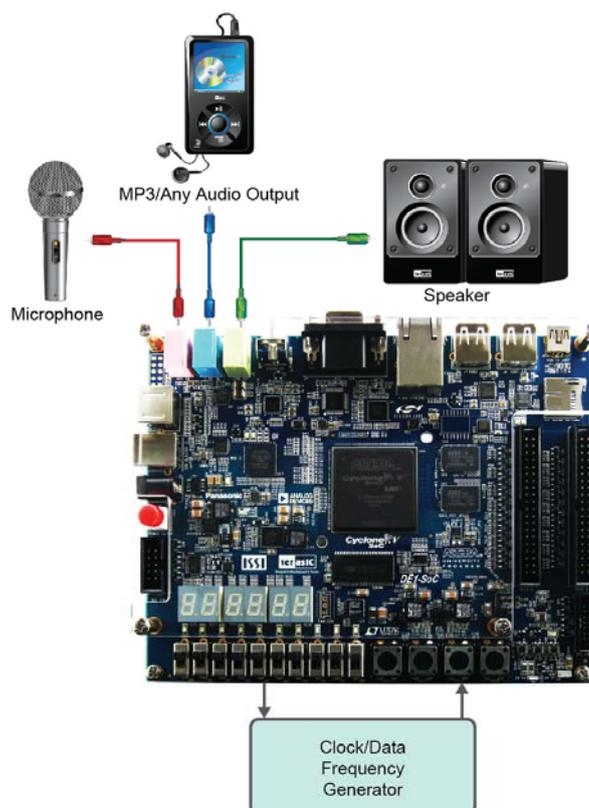


**Figure 5-4** Block diagram of the Karaoke machine demonstration

## ■ Demonstration Setup, File Locations, and Instructions

- Project directory: DE1\_SOC\_i2sound
- Bitstream used: DE1\_SOC\_i2sound.sof
- Connect a microphone to the microphone-in port (pink color)
- Connect the audio output of a music player, such as a MP3 player or computer, to the line-in port (blue color)
- Connect a headset/speaker to the line-out port (green color)
- Load the bitstream into the FPGA by executing the batch file 'DE1\_SOC\_i2sound' in the directory DE1\_SOC\_i2sound\demo\_batch
- Users should be able to hear a mixture of microphone sound and the sound from the music player
- Press KEY0 to adjust the volume; it cycles between volume level 0 to 9

**Figure 5-5** illustrates the setup for this demonstration.



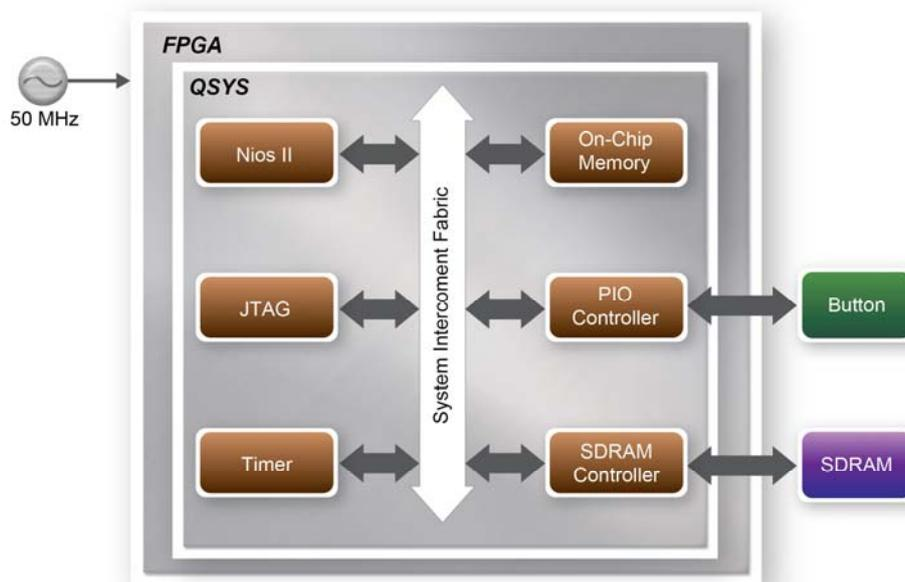
**Figure 5-5 Setup for the Karaoke machine**

## 5.4 SDRAM Test in Nios II

There are many applications use SDRAM as a temporary storage. Both hardware and software designs are provided to illustrate how to perform memory access in Qsys in this demonstration. It also shows how Altera's SDRAM controller IP accesses SDRAM and how the Nios II processor reads and writes the SDRAM for hardware verification. The SDRAM controller handles complex aspects of accessing SDRAM such as initializing the memory device, managing SDRAM banks, and keeping the devices refreshed at certain interval.

### ■ System Block Diagram

**Figure 5-6** shows the system block diagram of this demonstration. The system requires a 50 MHz clock input from the board. The SDRAM controller is configured as a 64MB controller. The working frequency of the SDRAM controller is 100MHz, and the Nios II program is running on the on-chip memory.



**Figure 5-6 Block diagram of the SDRAM test in Nios II**

The system flow is controlled by a program running in Nios II. The Nios II program writes test patterns into the entire 64MB of SDRAM first before calling the Nios II system function, `alt_dcache_flush_all`, to make sure all the data are written to the SDRAM. It then reads data from the SDRAM for data verification. The program will show the progress in nios-terminal when writing/reading data to/from the SDRAM. When the verification process reaches 100%, the result will be displayed in nios-terminal.

## ■ Design Tools

- Quartus II v13.1
- Nios II Eclipse v13.1

## ■ Demonstration Source Code

- Quartus project directory: `DE1_SoC_SDRAM_Nios_Test`
- Nios II Eclipse directory: `DE1_SoC_SDRAM_Nios_Test \Software`

## ■ Nios II Project Compilation

- Click “Clean” from the “Project” menu of Nios II Eclipse before compiling the reference design in Nios II Eclipse.

## ■ Demonstration Batch File

The files are located in the directory \DE1\_SoC\_SDRAM\_Nios\_Test\demo\_batch.

The folder includes the following files:

- Batch file for USB-Blaster II : DE1\_SoC\_SDRAM\_Nios\_Test.bat and DE1\_SoC\_SDRAM\_Nios\_Test\_bashrc
- FPGA configuration file : DE1\_SoC\_SDRAM\_Nios\_Test.sof
- Nios II program: DE1\_SoC\_SDRAM\_Nios\_Test.elf

## ■ Demonstration Setup

- Quartus II v13.1 and Nios II v13.1 must be pre-installed on the host PC.
- Power on the DE1-SoC board.
- Connect the DE1-SoC board (J13) to the host PC with a USB cable and install the USB-Blaster driver if necessary.
- Execute the demo batch file “DE1\_SoC\_SDRAM\_Nios\_Test.bat” from the directory DE1\_SoC\_SDRAM\_Nios\_Test\demo\_batch
- After the program is downloaded and executed successfully, a prompt message will be displayed in nios2-terminal.
- Press any button (**KEY3~KEY0**) to start the SDRAM verification process. Press **KEY0** to run the test continuously.
- The program will display the test progress and result, as shown in **Figure 5-7**.

```

Altera Nios II EDS 13.0 [gcc4]
Info: Quartus II 32-bit Programmer was successful. 0 errors, 0 warnings
Info: Peak virtual memory: 192 megabytes
Info: Processing ended: Wed Sep 04 15:22:21 2013
Info: Elapsed time: 00:00:06
Info: Total CPU time (on all processors): 00:00:02
Using cable "DE-SoC [USB-1]", device 1, instance 0x00
Resetting and pausing target processor: OK
Initializing CPU cache (if present)
OK
Downloaded 61KB in 0.1s
Verified OK
Starting processor at address 0x200201B4
nios2-terminal: connected to hardware target using JTAG UART on cable
nios2-terminal: "DE-SoC [USB-1]", device 1, instance 0
nios2-terminal: (Use the IDE stop button or Ctrl-C to terminate)

==== SDRAM Test! Size=64MB (CPU Clock:100000000) ====
=====
Press any KEY to start test [KEY0 for continued test]
====> SDRAM Testing, Iteration: 1
write...
10% 20% 30% 40% 50% 60% 70% 80% 90% 100%
read/verify...
10% 20% 30% 40% 50%

```

Figure 5-7 Display of progress and result for the SDRAM test in Nios II

## 5.5 SDRAM Test in Verilog

DE1-SoC system CD offers another SDRAM test with its test code written in Verilog HDL. The memory size of the SDRAM bank tested is still 64MB.

### ■ Function Block Diagram

Figure 5-8 shows the function block diagram of this demonstration. The SDRAM controller uses 50 MHz as a reference clock and generates 100 MHz as the memory clock.

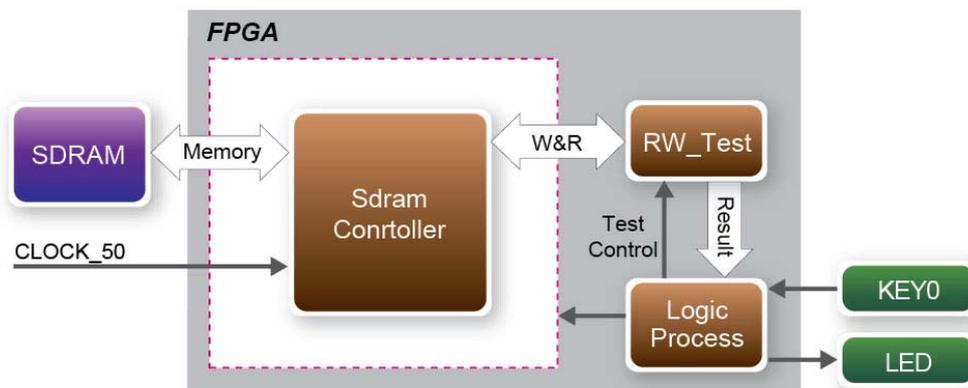


Figure 5-8 Block diagram of the SDRAM test in Verilog

RW\_test module writes the entire memory with a test sequence first before comparing the data read back with the regenerated test sequence, which is same as the data written to the memory. **KEY0** triggers test control signals for the SDRAM, and the LEDs will indicate the test result according to [Table 5-3](#).

## ■ Design Tools

- Quartus II v13.1

## ■ Demonstration Source Code

- Project directory: DE1\_SoC\_SDRAM\_RTL\_Test
- Bitstream used: DE1\_SoC\_SDRAM\_RTL\_Test.sof

## ■ Demonstration Batch File

Demo batch file folder: \DE1\_SoC\_SDRAM\_RTL\_Test\demo\_batch

The directory includes the following files:

- Batch file: DE1\_SoC\_SDRAM\_RTL\_Test.bat
- FPGA configuration file: DE1\_SoC\_SDRAM\_RTL\_Test.sof

## ■ Demonstration Setup

- Quartus II v13.1 must be pre-installed to the host PC.
- Connect the DE1-SoC board (J13) to the host PC with a USB cable and install the USB-Blaster II driver if necessary
- Power on the DE1\_SoC board.
- Execute the demo batch file “DE1\_SoC\_SDRAM\_RTL\_Test.bat” from the directory \DE1\_SoC\_SDRAM\_RTL\_Test\demo\_batch.
- Press **KEY0** on the DE1\_SoC board to start the verification process. When **KEY0** is pressed, the **LEDR** [2:0] should turn on. When **KEY0** is then released, **LEDR1** and **LEDR2** should start blinking.
- After approximately 8 seconds, **LEDR1** should stop blinking and stay ON to indicate the test is PASS. [Table 5-3](#) lists the status of **LED** indicators.
- If **LEDR2** is not blinking, it means 50MHz clock source is not working.
- If **LEDR1** failed to remain ON after approximately 8 seconds, the SDRAM test is NG.
- Press **KEY0** again to repeat the SDRAM test.

**Table 5-3 Status of LED Indicators**

Name	Description
LEDR0	Reset
LEDR1	ON if the test is PASS after releasing KEY0
LEDR2	Blinks

## 5.6 TV Box Demonstration

This demonstration turns DE1-SoC board into a TV box by playing video and audio from a DVD player using the VGA output, audio CODEC and the TV decoder on the DE1-SoC board. **Figure 5-9** shows the block diagram of the design. There are two major blocks in the system called I2C\_AV\_Config and TV\_to\_VGA. The TV\_to\_VGA block consists of the ITU-R 656 Decoder, SDRAM Frame Buffer, YUV422 to YUV444, YCbCr to RGB, and VGA Controller. The figure also shows the TV decoder (ADV7180) and the VGA DAC (ADV7123) chip used.

The register values of the TV decoder are used to configure the TV decoder via the I2C\_AV\_Config block, which uses the I2C protocol to communicate with the TV decoder. The TV decoder will be unstable for a time period upon power up, and the Lock Detector block is responsible for detecting this instability.

The ITU-R 656 Decoder block extracts YcrCb 4:2:2 (YUV 4:2:2) video signals from the ITU-R 656 data stream sent from the TV decoder. It also generates a data valid control signal, which indicates the valid period of data output. De-interlacing needs to be performed on the data source because the video signal for the TV decoder is interlaced. The SDRAM Frame Buffer and a field selection multiplexer (MUX), which is controlled by the VGA Controller, are used to perform the de-interlacing operation. The VGA Controller also generates data request and odd/even selection signals to the SDRAM Frame Buffer and field selection multiplexer (MUX). The YUV422 to YUV444 block converts the selected YcrCb 4:2:2 (YUV 4:2:2) video data to the YcrCb 4:4:4 (YUV 4:4:4) video data format.

Finally, the YcrCb\_to\_RGB block converts the YcrCb data into RGB data output. The VGA Controller block generates standard VGA synchronous signals VGA\_HS and VGA\_VS to enable the display on a VGA monitor.



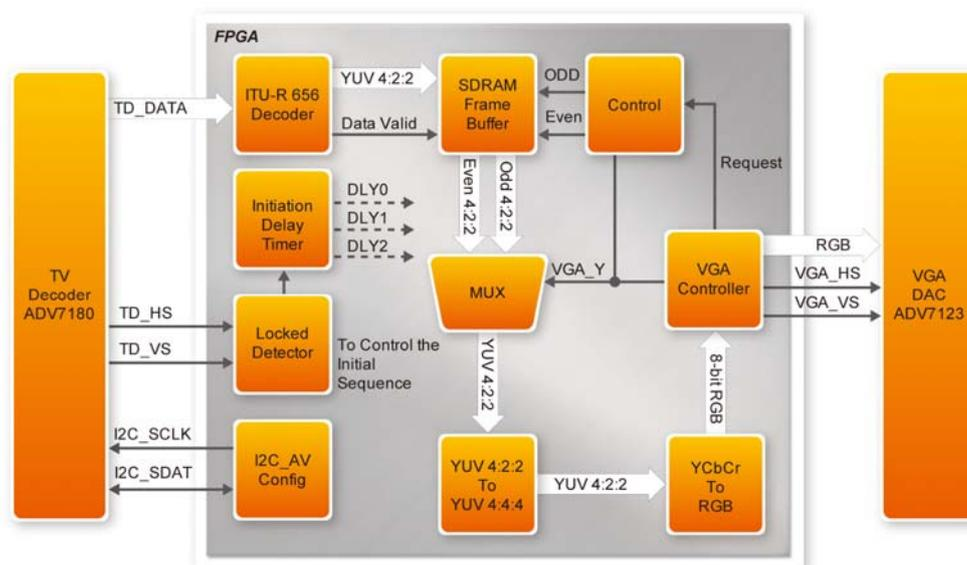


Figure 5-9 Block diagram of the TV box demonstration

## Demonstration Source Code

- Project directory: DE1\_SoC\_TV
- Bitstream used: DE1\_SoC\_TV.sof

## Demonstration Batch File

Demo batch directory: \DE1\_SoC\_TV \demo\_batch

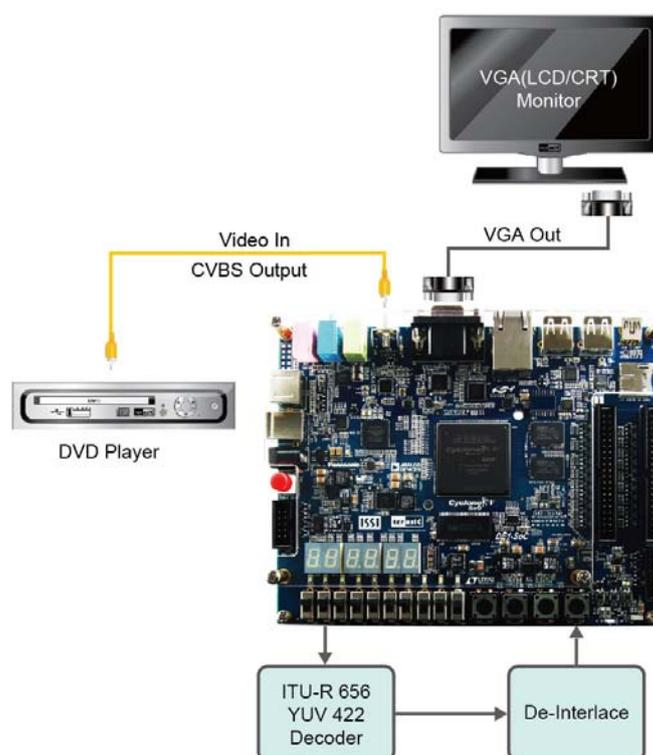
The folder includes the following files:

- Batch file: DE1\_SoC\_TV.bat
- FPGA configuration file : DE1\_SoC\_TV.sof

## Demonstration Setup, File Locations, and Instructions

- Connect a DVD player's composite video output (yellow plug) to the Video-in RCA jack (J6) on the DE1-SoC board, as shown in **Figure 5-10**. The DVD player has to be configured to provide:
  - NTSC output
  - 60Hz refresh rate
  - 4:3 aspect ratio
  - Non-progressive video

- Connect the VGA output of the DE1-SoC board to a VGA monitor.
- Connect the audio output of the DVD player to the line-in port of the DE1-SoC board and connect a speaker to the line-out port. If the audio output jacks from the DVD player are RCA type, an adaptor is needed to convert to the mini-stereo plug supported on the DE1-SoC board.
- Load the bitstream into the FPGA by executing the batch file 'DE1\_SoC\_TV.bat' from the directory \DE1\_SoC\_TV \demo\_batch\. Press KEY0 on the DE1-SoC board to reset the demonstration.



**Figure 5-10 Setup for the TV box demonstration**

## 5.7 PS/2 Mouse Demonstration

A simply PS/2 controller coded in Verilog HDL is provided to demonstrate bi-directional communication with a PS/2 mouse. A comprehensive PS/2 controller can be developed based on it and more sophisticated functions can be implemented such as setting the sampling rate or resolution, which needs to transfer two data bytes at once.

More information about the PS/2 protocol can be found on various websites.

## ■ Introduction

PS/2 protocol uses two wires for bi-directional communication. One is the clock line and the other one is the data line. The PS/2 controller always has total control over the transmission line, but it is the PS/2 device which generates the clock signal during data transmission.

## ■ Data Transmission from Device to the Controller

After the PS/2 mouse receives an enabling signal at stream mode, it will start sending out displacement data, which consists of 33 bits. The frame data is cut into three sections and each of them contains a start bit (always zero), eight data bits (with LSB first), one parity check bit (odd check), and one stop bit (always one).

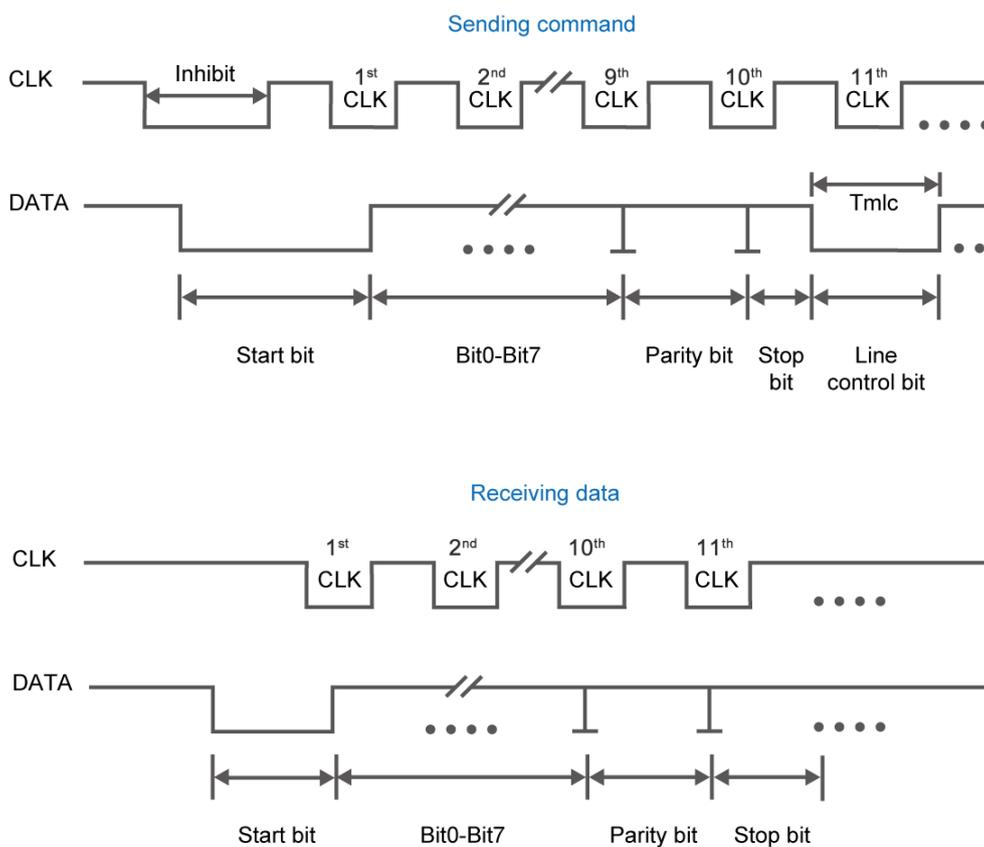
The PS/2 controller samples the data line at the falling edge of the PS/2 clock signal. This is implemented by a shift register, which consists of 33 bits.

easily be implemented using a shift register of 33 bits, but be cautious with the clock domain crossing problem.

## ■ Data Transmission from the Controller to Device

When the PS/2 controller wants to transmit data to device, it first pulls the clock line low for more than one clock cycle to inhibit the current transmission process or to indicate the start of a new transmission process, which is usually called as inhibit state. It then pulls low the data line before releasing the clock line. This is called the request state. The rising edge on the clock line formed by the release action can also be used to indicate the sample time point as for a 'start bit. The device will detect this succession and generates a clock sequence in less than 10ms time. The transmit data consists of 12bits, one start bit (as explained before), eight data bits, one parity check bit (odd check), one stop bit (always one), and one acknowledge bit (always zero). After sending out the parity check bit, the controller should release the data line, and the device will detect any state change on the data line in the next clock cycle. If there's no change on the data line for one clock cycle, the device will pull low the data line again as an acknowledgement which means that the data is correctly received.

After the power on cycle of the PS/2 mouse, it enters into stream mode automatically and disable data transmit unless an enabling instruction is received. **Figure 5-11** shows the waveform while communication happening on two lines.



**Figure 5-11 Waveform of clock and data signals during data transmission**

## Demonstration Source Code

- Project directory: DE1\_SoC\_PS2\_DEMO
- Bitstream used: DE1\_SoC\_PS2\_DEMO.sof

## Demonstration Batch File

Demo batch file directoy: \DE1\_SoC\_PS2\_DEMO \demo\_batch

The folder includes the following files:

- Batch file: DE1\_SoC\_PS2\_DEMO.bat
- FPGA configuration file : DE1\_SoC\_PS2\_DEMO.sof

## Demonstration Setup, File Locations, and Instructions

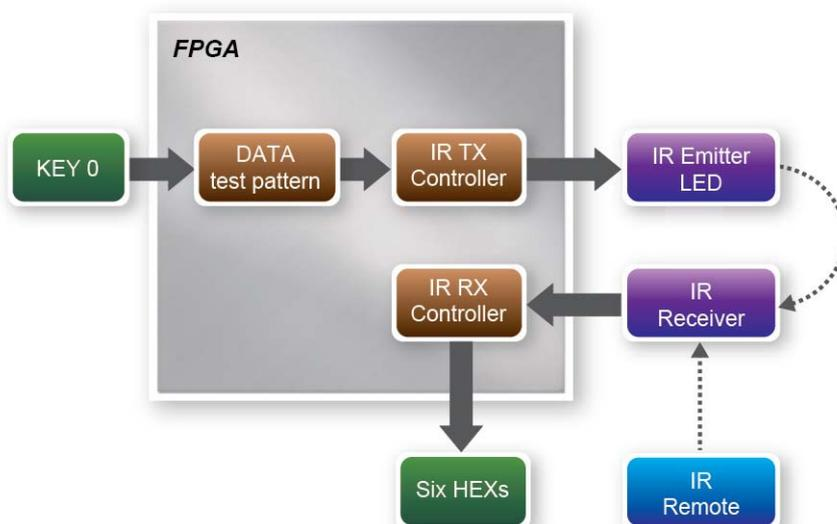
- Load the bitstream into the FPGA by executing `\DE1_SoC_PS2_DEMO\demo_batch\DE1_SoC_PS2_DEMO.bat`
- Plug in the PS/2 mouse
- Press KEY[0] to enable data transfer
- Press KEY[1] to clear the display data cache
- The 7-segment display should change when the PS/2 mouse moves. The LEDR[2:0] will blink according to **Table 5-4** when the left-button, right-button, and/or middle-button is pressed.

**Table 5-4 Description of 7-segment Display and LED Indicators**

<i>Indicator Name</i>	<i>Description</i>
LEDR[0]	Left button press indicator
LEDR[1]	Right button press indicator
LEDR[2]	Middle button press indicator
HEX0	Low byte of X displacement
HEX1	High byte of X displacement
HEX2	Low byte of Y displacement
HEX3	High byte of Y displacement

## 5.8 IR Emitter LED and Receiver Demonstration

DE1-SoC system CD has an example of using the IR Emitter LED and IR receiver. This demonstration is coded in Verilog HDL.



**Figure 5-12 Block diagram of the IR emitter LED and receiver demonstration**

**Figure 5-12** shows the block diagram of the design. It implements a IR TX Controller and a IR RX Controller. When KEY0 is pressed, data test pattern generator will generate data to the IR TX Controller continuously. When IR TX Controller is active, it will format the data to be compatible with NEC IR transmission protocol and send it out through the IR emitter LED. The IR receiver will decode the received data and display it on the six HEXs. Users can also use a remote to send data to the IR Receiver. The main function of IR TX /RX controller and IR remote in this demonstration is described in the following sections.

## ■ IR TX Controller

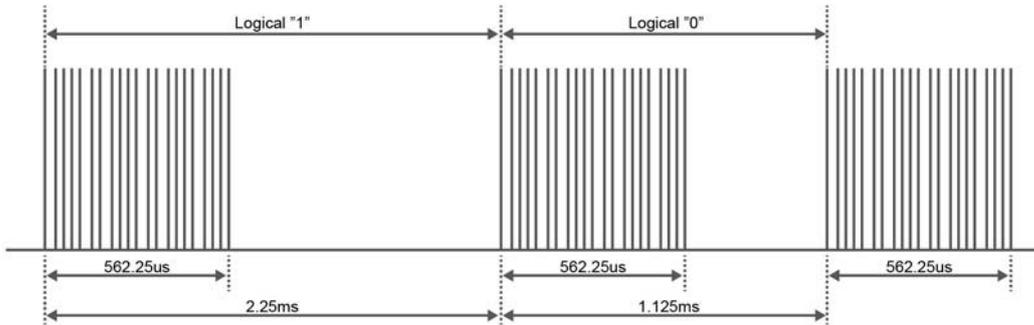
Users can input 8-bit address and 8-bit command into the IR TX Controller. The IR TX Controller will encode the address and command first before sending it out according to NEC IR transmission protocol through the IR emitter LED. The input clock of IR TX Controller should be 50MHz.

The NEC IR transmission protocol uses pulse distance to encode the message bits. Each pulse burst is 562.5 $\mu$ s in length with a carrier frequency of 38kHz (26.3 $\mu$ s).

**Figure 5-13** shows the duration of logical “1” and “0”. Logical bits are transmitted as follows:

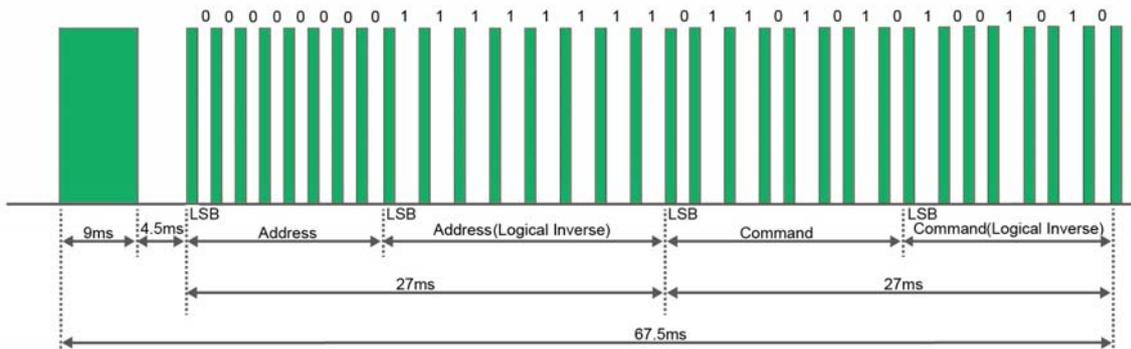
- Logical '0' – a 562.5 $\mu$ s pulse burst followed by a 562.5 $\mu$ s space with a total transmit time of 1.125ms

- Logical '1' – a 562.5µs pulse burst followed by a 1.6875ms space with a total transmit time of 2.25ms



**Figure 5-13 Duration of logical “1”and logical “0”**

**Figure 5-14** shows a frame of the protocol. Protocol sends a lead code first, which is a 9ms leading pulse burst, followed by a 4.5ms window. The second inversed data is sent to verify the accuracy of the information received. A final 562.5µs pulse burst is sent to signify the end of message transmission. Because the data is sent in pair (original and inverted) according to the protocol, the overall transmission time is constant.



**Figure 5-14 Typical frame of NEC protocol**

Note: The signal received by IR Receiver is inverted. For instance, if IR TX Controller sends a lead code 9 ms high and then 4.5 ms low, IR Receiver will receive a 9 ms low and then 4.5 ms high lead code.

## ■ IR Remote

When a key on the remote controller shown in **Figure 5-15** is pressed, the remote controller will emit a standard frame, as shown in **Table 5-5**. The beginning of the frame is the lead code, which represents the start bit, followed by the key-related information. The last bit end code represents the end of the frame. The value of this frame is completely inverted at the receiving end.

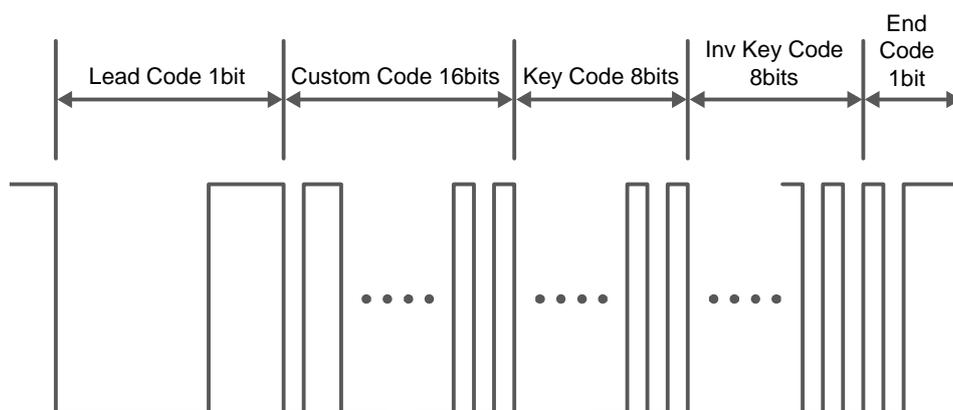


**Figure 5-15** The remote controller used in this demonstration

**Table 5-5** Key Code Information for Each Key on the Remote

Key	Key Code	Key	Key Code	Key	Key Code	Key	Key Code
	0x0F		0x13		0x10		0x12
	0x01		0x02		0x03		0x1A
	0x04		0x05		0x06		0x1E
	0x07		0x08		0x09		0x1B
	0x11		0x00		0x17		0x1F
	0x16		0x14		0x18		0x0C



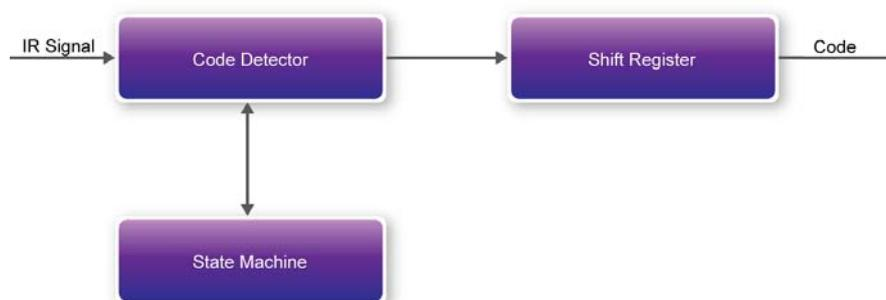


**Figure 5-16 The transmitting frame of the IR remote controller**

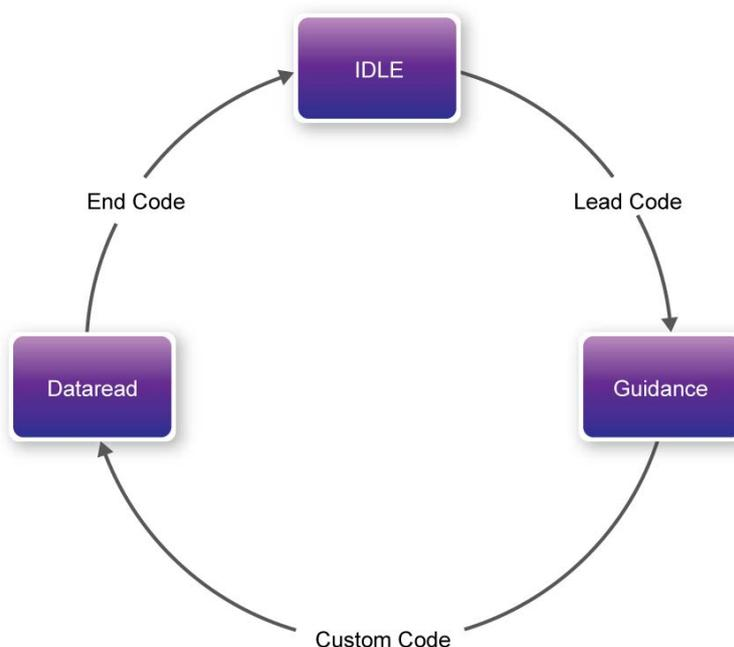
## ■ IR RX Controller

The following demonstration shows how to implement the IP of IR receiver controller in the FPGA. **Figure 5-17** shows the modules used in this demo, including Code Detector, State Machine, and Shift Register. At the beginning the IR receiver demodulates the signal inputs to the Code Detector. The Code Detector will check the Lead Code and feedback the examination result to the State Machine.

The State Machine block will change the state from IDLE to GUIDANCE once the Lead Code is detected. If the Code Detector detects the Custom Code status, the current state will change from GUIDANCE to DATAREAD state. The Code Detector will also save the receiving data and output to the Shift Register and display on the 7-segment. **Figure 5-18** shows the state shift diagram of State Machine block. The input clock should be 50MHz.



**Figure 5-17 Modules in the IR Receiver controller**



**Figure 5-18 State shift diagram of State Machine block**

## Demonstration Source Code

- Project directory: DE1\_SoC\_IR
- Bitstream used: DE1\_SOC\_IR.sof

## Demonstration Batch File

Demo batch file directory: DE1\_SoC\_IR \demo\_batch

The folder includes the following files:

- Batch file: DE1\_SoC\_IR.bat
- FPGA configuration file : DE1\_SOC\_IR.sof

## Demonstration Setup, File Locations, and Instructions

- Load the bitstream into the FPGA by executing DE1\_SoC\_IR \demo\_batch\ DE1\_SoC\_IR.bat
- Keep pressing KEY[0] to enable the pattern to be sent out continuously by the IR TX Controller.
- Observe the six HEXs according to **Table 5-6**
- Release KEY[0] to stop the IR TX.
- Point the IR receiver with the remote and press any button

- Observe the six HEXs according to **Table 5-6**

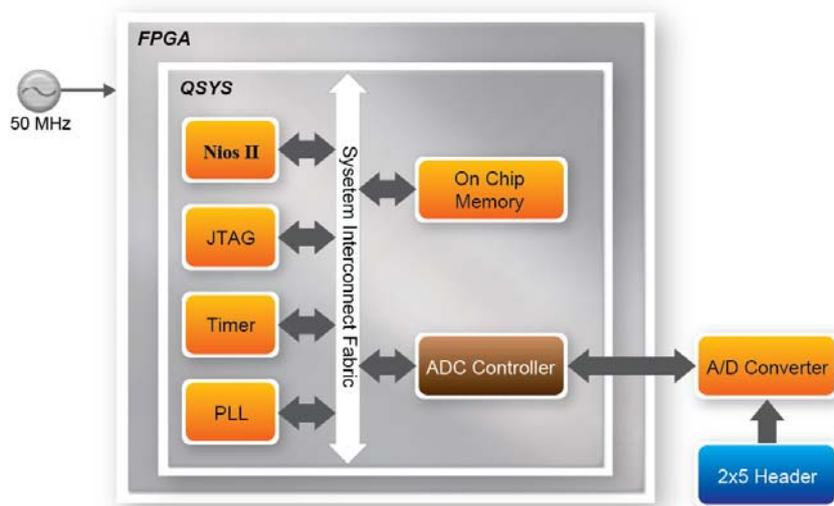
**Table 5-6 Detailed Information of the Indicators**

<i>Indicator Name</i>	<i>Description</i>
HEX5	Inversed high byte of DATA(Key Code)
HEX4	Inversed low byte of DATA(Key Code)
HEX3	High byte of ADDRESS(Custom Code)
HEX2	Low byte of ADDRESS(Custom Code)
HEX1	High byte of DATA(Key Code)
HEX0	Low byte of DATA (Key Code)

## 5.9 ADC Reading

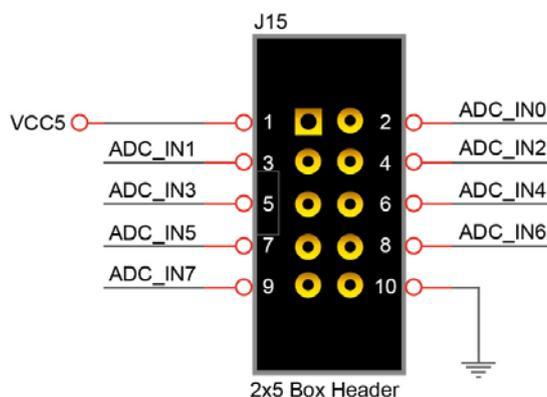
This demonstration illustrates steps to evaluate the performance of the 8-channel 12-bit A/D Converter ADC7928. The DC 5.0V on the 2x5 header is used to drive the analog signals by a trimmer potentiometer. The voltage can be adjusted within the range between 0 and 5.0V. The 12-bit voltage measurement is displayed on the NIOS II console. **Figure 5-19** shows the block diagram of this demonstration.

If the input voltage is -2.5V ~ 2.5V, a pre-scale circuit can be used to adjust it to 0 ~ 5V.



**Figure 5-19 Block diagram of ADC reading**

**Figure 5-20** depicts the pin arrangement of the 2x5 header. This header is the input source of ADC convertor in this demonstration. Users can connect a trimmer to the specified ADC channel (ADC\_IN0 ~ ADC\_IN7) that provides voltage to the ADC convert. The FPGA will read the associated register in the convertor via serial interface and translates it to voltage value to be displayed on the Nios II console.



**Figure 5-20 Pin distribution of the 2x5 Header for the ADC**

## ■ System Requirements

The following items are required for this demonstration.

- DE1-SoC board x1
- Trimmer Potentiometer x1
- Wire Strip x3

## ■ Demonstration File Locations

- Hardware project directory: DE1\_SoC\_ADC
- Bitstream used: DE1\_SoC\_ADC.sof
- Software project directory: DE1\_SoC\_ADC software
- Demo batch file : DE1\_SoC\_ADC\demo\_batch\DE1\_SoC\_ADC.bat

## ■ Demonstration Setup and Instructions

- Connect the trimmer to corresponding ADC channel on the 2x5 header, as shown in **Figure 5-21**, as well as the +5V and GND signals. The setup shown above is connected to ADC channel 0.
- Execute the demo batch file DE1\_SoC\_ADC.bat to load the bitstream and software execution file to the FPGA.
- The Nios II console will display the voltage of the specified channel voltage result information

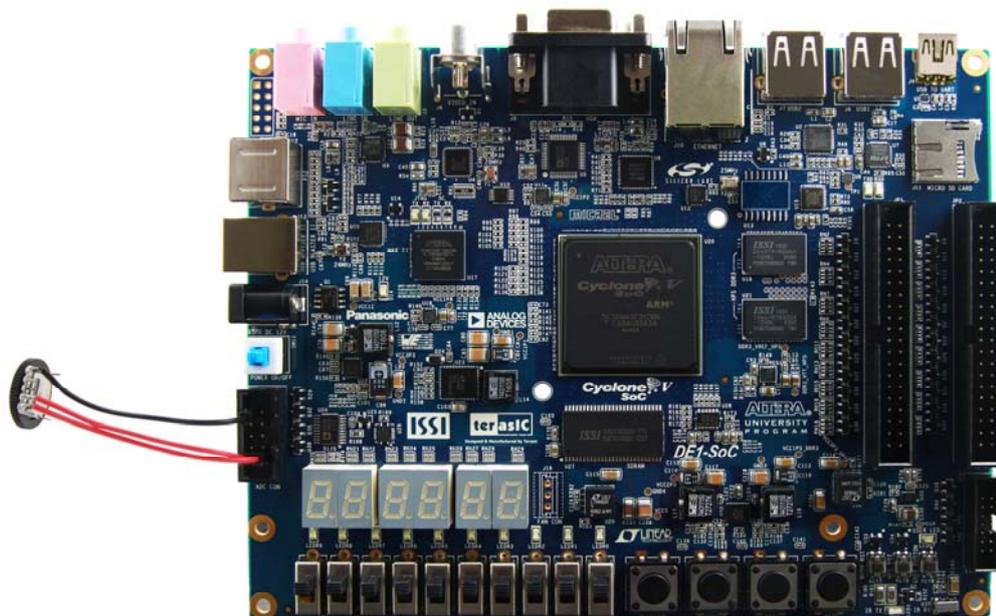


Figure 5-21 Hardware setup for the ADC reading demonstration

## Chapter 6

# *Examples for HPS*

## *SoC*

This chapter provides several C-code examples based on the Altera SoC Linux built by Yocto project. These examples demonstrates major features connected to HPS interface on DE1-SoC board such as users LED/KEY, I2C interfaced G-sensor, and I2C MUX. All the associated files can be found in the directory *Demonstrations/SOC* of the DE1\_SoC System CD. Please refer to Chapter 5 "**Running Linux on the DE1-SoC board**" from the *DE1-SoC\_Getting\_Started\_Guide.pdf* to run Linux on DE1-SoC board.

### ■ Installation of the Demonstrations

To install the demonstrations on the host computer:

Copy the directory *Demonstrations* into a local directory of your choice. **Altera SoC EDS v13.1 is required for users to compile the c-code project.**

## 6.1 Hello Program

This demonstration shows how to develop first HPS program with Altera SoC EDS tool. Please refer to *My\_First\_HPS.pdf* from the system CD for more details.

The major procedures to develop and build HPS project are:

- Install Altera SoC EDS on the host PC.
- Create program .c/.h files with a generic text editor
- Create a "Makefile" with a generic text editor
- Build the project under Altera SoC EDS

## ■ Program File

The main program for the Hello World demonstration is:

```
#include <stdio.h>

int main(int argc, char **argv) {
    printf("Hello World!\r\n");
    return( 0 );
}
```

## ■ Makefile

A Makefile is required to compile a project. The Makefile used for this demo is:

```
#
TARGET = my_first_hps

#
CROSS_COMPILE = arm-linux-gnueabi-
CFLAGS = -g -Wall -I $(SOCEDS_DEST_ROOT)/ip/altera/hps/altera_hps/hwlib/include
LDFLAGS = -g -Wall
CC = $(CROSS_COMPILE)gcc
ARCH= arm

build: $(TARGET)

$(TARGET): main.o
    $(CC) $(LDFLAGS)  $^ -o $@

%.o : %.c
    $(CC) $(CFLAGS) -c $< -o $@

.PHONY: clean
clean:
    rm -f $(TARGET) *.a *.o *~
```

## ■ Compile

Please launch Altera SoC EDS Command Shell to compile a project by executing

C:\altera\13.1\embedded\Embedded\_Command\_Shell.bat

The "cd" command can change the current directory to where the Hello World project is located.

The "make" command will build the project. The executable file "**my\_first\_hps**" will be generated after the compiling process is successful. The "clean all" command removes all temporary files.

### ■ Demonstration Source Code

- Build tool: Altera SoC EDS v13.1
- Project directory: \Demonstration\SoC\my\_first\_hps
- Binary file: my\_first\_hps
- Build command: make ("**make clean**" to remove all temporary files)
- Execute command: ./my\_first\_hps

### ■ Demonstration Setup

- Connect a USB cable to the USB-to-UART connector (J4) on the DE1-SoC board and the host PC.
- Copy the demo file "**my\_first\_hps**" into a microSD card under the "**/home/root**" folder in Linux.
- Insert the booting microSD card into the DE1-SoC board.
- Power on the DE1-SoC board.
- Launch PuTTY and establish connection to the UART port of Putty. Type "**root**" to login Altera Yocto Linux.
- Type "**./my\_first\_hps**" in the UART terminal of PuTTY to start the program, and the "Hello World!" message will be displayed in the terminal.

```
root@socfpga:~# ./my_first_hps
Hello World!
root@socfpga:~#
```

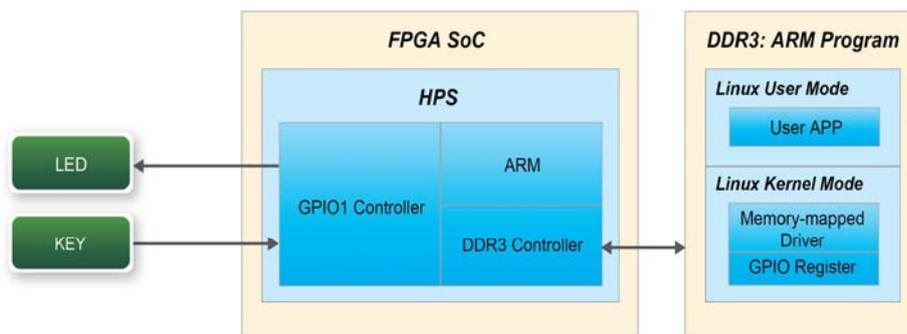
## 6.2 Users LED and KEY

This demonstration shows how to control the users LED and KEY by accessing the register of GPIO controller through the memory-mapped device driver. The memory-mapped device driver allows developer to access the system physical memory.

### ■ Function Block Diagram

**Figure 6-1** shows the function block diagram of this demonstration. The users LED and KEY are connected to the **GPIO1** controller in HPS. The behavior of GPIO controller is controlled by the register in GPIO controller. The registers can be accessed by application software through the memory-mapped device driver, which is built into Altera SoC Linux.

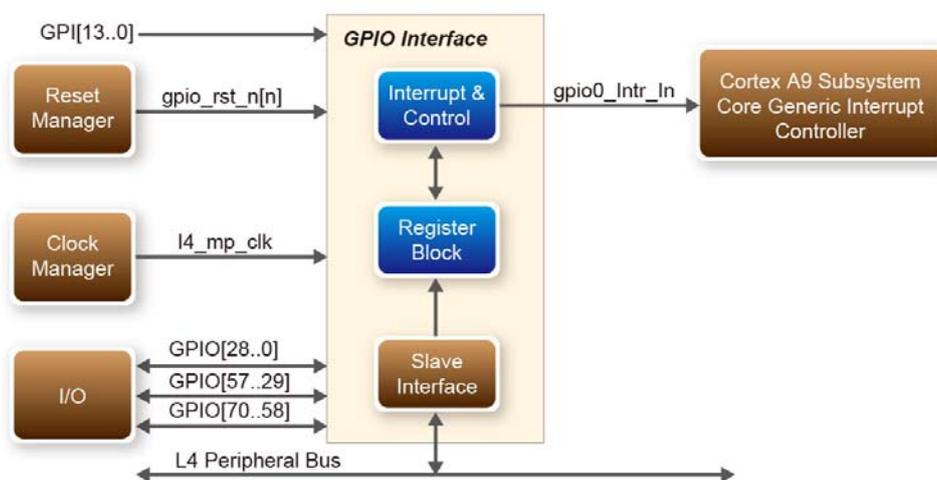




**Figure 6-1** Block diagram of GPIO demonstration

### ■ Block Diagram of GPIO Interface

The HPS provides three general-purpose I/O (GPIO) interface modules. **Figure 6-2** shows the block diagram of GPIO Interface. GPIO[28..0] is controlled by the GPIO0 controller and GPIO[57..29] is controlled by the GPIO1 controller. GPIO[70..58] and input-only GPI[13..0] are controlled by the GPIO2 controller.



**Figure 6-2** Block diagram of GPIO Interface

## ■ GPIO Register Block

The behavior of I/O pin is controlled by the registers in the register block. There are three 32-bit registers in the GPIO controller used in this demonstration. The registers are:

- **gpio\_swporta\_dr**: write output data to output I/O pin
- **gpio\_swporta\_ddr**: configure the direction of I/O pin
- **gpio\_ext\_porta**: read input data of I/O input pin

The **gpio\_swporta\_ddr** configures the LED pin as output pin and drives it high or low by writing data to the **gpio\_swporta\_dr** register. The first bit (least significant bit) of **gpio\_swporta\_dr** controls the direction of first IO pin in the associated GPIO controller and the second bit controls the direction of second IO pin in the associated GPIO controller and so on. The value "1" in the register bit indicates the I/O direction is output, and the value "0" in the register bit indicates the I/O direction is input.

The first bit of **gpio\_swporta\_dr** register controls the output value of first I/O pin in the associated GPIO controller, and the second bit controls the output value of second I/O pin in the associated GPIO controller and so on. The value "1" in the register bit indicates the output value is high, and the value "0" indicates the output value is low.

The status of KEY can be queried by reading the value of **gpio\_ext\_porta** register. The first bit represents the input status of first IO pin in the associated GPIO controller, and the second bit represents the input status of second IO pin in the associated GPIO controller and so on. The value "1" in the register bit indicates the input state is high, and the value "0" indicates the input state is low.

## ■ GPIO Register Address Mapping

The registers of HPS peripherals are mapped to HPS base address space 0xFC000000 with 64KB size. The registers of the GPIO1 controller are mapped to the base address 0xFF708000 with 4KB size, and the registers of the GPIO2 controller are mapped to the base address 0xFF70A000 with 4KB size, as shown in [Figure 6-3](#).



```
#include <sys/mman.h>
#include "hwlib.h"
#include "socal/socal.h"
#include "socal/hps.h"
#include "socal/alt_gpio.h"
```

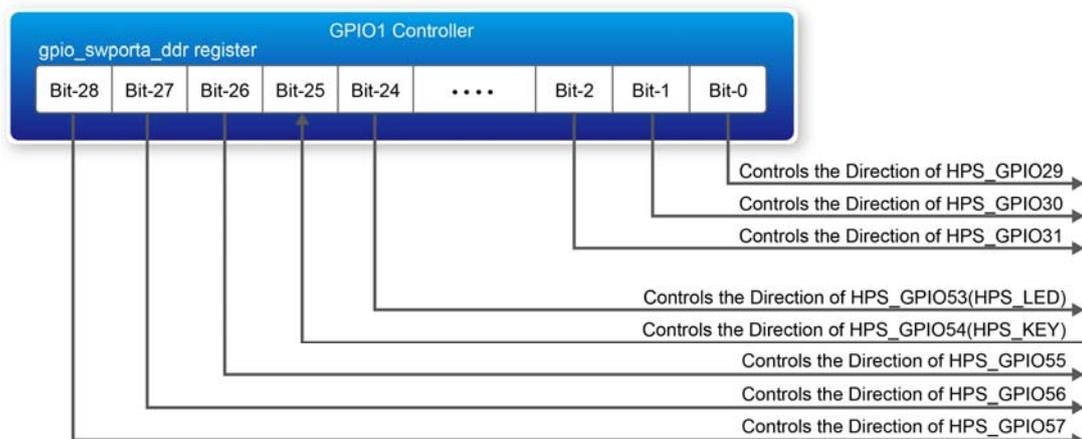
## ■ LED and KEY Control

Figure 6-4 shows the HPS users LED and KEY pin assignment for the DE1\_SoC board. The LED is connected to HPS\_GPIO53 and the KEY is connected to HPS\_GPIO54. They are controlled by the GPIO1 controller, which also controls HPS\_GPIO29 ~ HPS\_GPIO57.

HPS_GPIO54	G21	HPS_KEY
HPS_GPIO53	A24	HPS_LED

Figure 6-4 Pin assignment of LED and KEY

Figure 6-5 shows the **gpio\_swporta\_dds** register of the GPIO1 controller. The bit-0 controls the pin direction of HPS\_GPIO29. The bit-24 controls the pin direction of HPS\_GPIO53, which connects to HPS\_LED, the bit-25 controls the pin direction of HPS\_GPIO54, which connects to HPS\_KEY and so on. The pin direction of HPS\_LED and HPS\_KEY are controlled by the bit-24 and bit-25 in the **gpio\_swporta\_dds** register of the GPIO1 controller, respectively. Similarly, the output status of HPS\_LED is controlled by the bit-24 in the **gpio\_swporta\_dr** register of the GPIO1 controller. The status of KEY can be queried by reading the value of the bit-24 in the **gpio\_ext\_porta** register of the GPIO1 controller.



**Figure 6-5 gpio\_swporta\_ddr register in the GPIO1 controller**

The following mask is defined in the demo code to control LED and KEY direction and LED's output value.

```
#define USER_IO_DIR      (0x01000000)

#define BIT_LED          (0x01000000)

#define BUTTON_MASK     (0x02000000)
```

The following statement is used to configure the LED associated pins as output pins.

```
alt_setbits_word( ( virtual_base +
( ( uint32_t)( ALT_GPIO1_SWPORTA_DDR_ADDR ) &
( uint32_t)( HW_REGS_MASK ) ), USER_IO_DIR );
```

The following statement is used to turn on the LED.

```
alt_setbits_word( ( virtual_base +
( ( uint32_t)( ALT_GPIO1_SWPORTA_DR_ADDR ) &
( uint32_t)( HW_REGS_MASK ) ), BIT_LED );
```

The following statement is used to read the content of **gpio\_ext\_porta** register. The bit mask is used to check the status of the key.

```
alt_read_word( ( virtual_base +
( ( uint32_t)( ALT_GPIO1_EXT_PORTA_ADDR ) &
( uint32_t)( HW_REGS_MASK ) ) );
```

## ■ Demonstration Source Code

- Build tool: Altera SoC EDS V13.1
- Project directory: \Demonstration\SoC\hps\_gpio
- Binary file: hps\_gpio
- Build command: make ('make clean' to remove all temporal files)
- Execute command: ./hps\_gpio

## ■ Demonstration Setup

- Connect a USB cable to the USB-to-UART connector (J4) on the DE1-SoC board and the host PC.
- Copy the executable file "**hps\_gpio**" into the microSD card under the **"/home/root"** folder in Linux.
- Insert the booting micro SD card into the DE1-SoC board.
- Power on the DE1-SoC board.
- Launch PuTTY and establish connection to the UART port of Putty. Type "**root**" to login Altera Yocto Linux.
- Type **"./hps\_gpio "** in the UART terminal of PuTTY to start the program.

```
root@socfpga:~# ./hps_gpio
led test
the led flash 2 times
user key test
press key to control led
```

- HPS\_LED will flash twice and users can control the user LED with push-button.
- Press HPS\_KEY to light up HPS\_LED.
- Press "CTRL + C" to terminate the application.

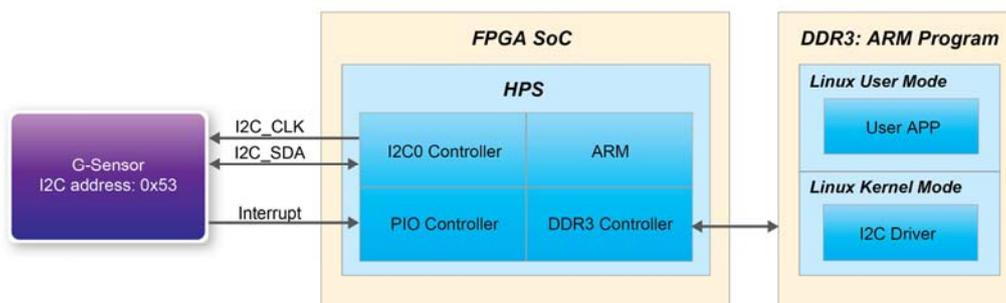
## 6.3 I2C Interfaced G-sensor

This demonstration shows how to control the G-sensor by accessing its registers through the built-in I2C kernel driver in [Altera Soc Yocto Powered Embedded Linux](#).

### ■ Function Block Diagram

**Figure 6-6** shows the function block diagram of this demonstration. The G-sensor on the DE1\_SoC board is connected to the **I2C0** controller in HPS. The G-Sensor I2C 7-bit device address is 0x53. The system I2C bus driver is used to access the register files in the G-sensor. The G-sensor interrupt

signal is connected to the PIO controller. This demonstration uses polling method to read the register data.



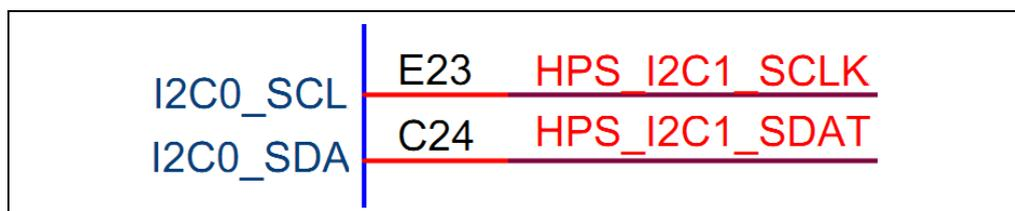
**Figure 6-6 Block diagram of the G-sensor demonstration**

## ■ I2C Driver

The procedures to read a register value from G-sensor register files by the existing I2C bus driver in the system are:

1. Open I2C bus driver "/dev/i2c-0": `file = open("/dev/i2c-0", O_RDWR);`
2. Specify G-sensor's I2C address 0x53: `ioctl(file, I2C_SLAVE, 0x53);`
3. Specify desired register index in g-sensor: `write(file, &Addr8, sizeof(unsigned char));`
4. Read one-byte register value: `read(file, &Data8, sizeof(unsigned char));`

The G-sensor I2C bus is connected to the I2C0 controller, as shown in the **Figure 6-7**. The driver name given is '/dev/i2c-0'.



**Figure 6-7 Connection of HPS I2C signals**

The step 4 above can be changed to the following to write a value into a register.

`write(file, &Data8, sizeof(unsigned char));`

The step 4 above can also be changed to the following to read multiple byte values.

read(file, &szData8, sizeof(szData8)); // where szData is an array of bytes

The step 4 above can be changed to the following to write multiple byte values.

write(file, &szData8, sizeof(szData8)); // where szData is an array of bytes

## ■ G-sensor Control

The ADI ADXL345 provides I2C and SPI interfaces. I2C interface is selected by setting the CS pin to high on the DE1\_SoC board.

The ADI ADXL345 G-sensor provides user-selectable resolution up to 13-bit  $\pm$  16g. The resolution can be configured through the DATA\_FORMAT(0x31) register. The data format in this demonstration is configured as:

- Full resolution mode
- $\pm$  16g range mode
- Left-justified mode

The X/Y/Z data value can be derived from the DATAX0(0x32), DATAX1(0x33), DATAY0(0x34), DATAY1(0x35), DATAZ0(0x36), and DATAZ1(0x37) registers. The DATAX0 represents the least significant byte and the DATAX1 represents the most significant byte. It is recommended to perform multiple-byte read of all registers to prevent change in data between sequential registers read. The following statement reads 6 bytes of X, Y, or Z value.

read(file, szData8, sizeof(szData8)); // where szData is an array of six-bytes

## ■ Demonstration Source Code

- Build tool: Altera SoC EDS v13.1
- Project directory: \Demonstration\SoC\hps\_gsensor
- Binary file: gsensor
- Build command: make ('make clean' to remove all temporal files)
- Execute command: ./gsensor [loop count]

## ■ Demonstration Setup

- Connect a USB cable to the USB-to-UART connector (J4) on the DE1-SoC board and the host PC.



- Copy the executable file "**gsensor**" into the microSD card under the "**/home/root**" folder in Linux.
- Insert the booting microSD card into the DE1-SoC board.
- Power on the DE1-SoC board.
- Launch PuTTY to establish connection to the UART port of DE1-SoC board. Type "**root**" to login Yocto Linux.
- Execute "**./gsensor**" in the UART terminal of PuTTY to start the G-sensor polling.
- The demo program will show the X, Y, and Z values in the PuTTY, as shown in **Figure 6-8**.

```
root@socfpga:~# ./gsensor
===== gsensor test =====
id=E5h
[1]X=80 mg, Y=-40 mg, Z=924 mg
[2]X=76 mg, Y=-32 mg, Z=972 mg
[3]X=76 mg, Y=-36 mg, Z=964 mg
[4]X=84 mg, Y=-36 mg, Z=976 mg
[5]X=76 mg, Y=-40 mg, Z=964 mg
[6]X=76 mg, Y=-40 mg, Z=972 mg
```

**Figure 6-8 Terminal output of the G-sensor demonstration**

- Press "CTRL + C" to terminate the program.

## 6.4 I2C MUX Test

The I2C bus on DE1-SoC is originally accessed by FPGA only. This demonstration shows how to switch the I2C multiplexer for HPS to access the I2C bus.

### ■ Function Block Diagram

**Figure 6-9** shows the function block diagram of this demonstration. The I2C bus from both FPGA and HPS are connected to an I2C multiplexer. It is controlled by HPS\_I2C\_CONTROL, which is connected to the **GPIO1** controller in HPS. The HPS I2C is connected to the **I2C0** controller in HPS, as well as the G-sensor.

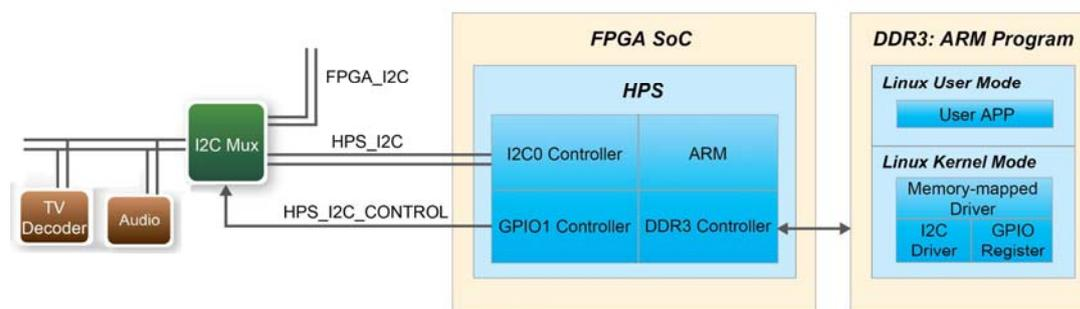


Figure 6-9 Block diagram of the I2C MUX test demonstration

## ■ HPS\_I2C\_CONTROL Control

HPS\_I2C\_CONTROL is connected to HPS\_GPIO48, which is bit-19 of the **GPIO1** controller. Once HPS gets access to the I2C bus, it can then access Audio CODEC and TV Decoder when the HPS\_I2C\_CONTROL signal is set to high.

The following mask in the demo code is defined to control the direction and output value of HPS\_I2C\_CONTROL.

```
#define HPS_I2C_CONTROL ( 0x00080000 )
```

The following statement is used to configure the HPS\_I2C\_CONTROL associated pins as output pin.

```
alt_setbits_word( ( virtual_base +  
( ( uint32_t)( ALT_GPIO1_SWPORTA_DDR_ADDR ) &  
( uint32_t)( HW_REGS_MASK ) ), HPS_I2C_CONTROL );
```

The following statement is used to set HPS\_I2C\_CONTROL high.

```
alt_setbits_word( ( virtual_base +  
( ( uint32_t)( ALT_GPIO1_SWPORTA_DR_ADDR ) &  
( uint32_t)( HW_REGS_MASK ) ), HPS_I2C_CONTROL );
```

The following statement is used to set HPS\_I2C\_CONTROL low.

```
alt_clrbits_word( ( virtual_base +  
( ( uint32_t)( ALT_GPIO1_SWPORTA_DR_ADDR ) &  
( uint32_t)( HW_REGS_MASK ) ), HPS_I2C_CONTROL );
```

## ■ I2C Driver

The procedures to read register value from TV Decoder by the existing I2C bus driver in the system are:

- Set HPS\_I2C\_CONTROL high for HPS to access I2C bus.
- Open the I2C bus driver "/dev/i2c-0": file = open("/dev/i2c-0", O\_RDWR);
- Specify the I2C address 0x20 of ADV7180: ioctl(file, I2C\_SLAVE, 0x20);
- Read or write registers;
- Set HPS\_I2C\_CONTROL low to release the I2C bus.

## ■ Demonstration Source Code

- Build tool: Altera SoC EDS v13.1
- Project directory: \Demonstration\SoC\ hps\_i2c\_switch
- Binary file: i2c\_switch
- Build command: make ('make clean' to remove all temporal files)
- Execute command: ./ i2c\_switch

## ■ Demonstration Setup

- Connect a USB cable to the USB-to-UART connector (J4) on the DE1-SoC board and host PC.
- Copy the executable file " **i2c\_switch** " into the microSD card under the **"/home/root"** folder in Linux.
- Insert the booting microSD card into the DE1-SoC board.
- Power on the DE1-SoC board.
- Launch PuTTY to establish connection to the UART port of DE1\_SoC board. Type **"root"** to login Yocto Linux.
- Execute **"./ i2c\_switch "** in the UART terminal of PuTTY to start the I2C MUX test.
- The demo program will show the result in the Putty, as shown in **Figure 6-10**.

```

root@socfpga:~# ./i2c_switch
I2C BUS Switch Test
HPS owns the I2C bus!!!
Open '/dev/i2c-0' successfully.
REG[11h]=1Ch (i2c addr:20h)
HPS release the I2C bus!!!
I2C Switch Test:Success
root@socfpga:~#

```

**Figure 6-10 Terminal output of the I2C MUX Test Demonstration**

- Press "CTRL + C" to terminate the program.

## Chapter 7

# *Examples for using both HPS SoC and FGPA*

Although HPS and FPGA can operate independently, they are tightly coupled via a high-bandwidth system interconnect built from high-performance ARM AMBA® AXITM bus bridges. Both FPGA fabric and HPS can access to each other via these interconnect bridges. This chapter provides demonstrations on how to achieve superior performance and lower latency through these interconnect bridges when comparing to solutions containing a separate FPGA and discrete processor.

### 7.1 HPS Control LED and HEX

This demonstration shows how HPS controls the FPGA LED and HEX through Lightweight HPS-to-FPGA Bridge. The FPGA is configured by HPS through FPGA manager in HPS.

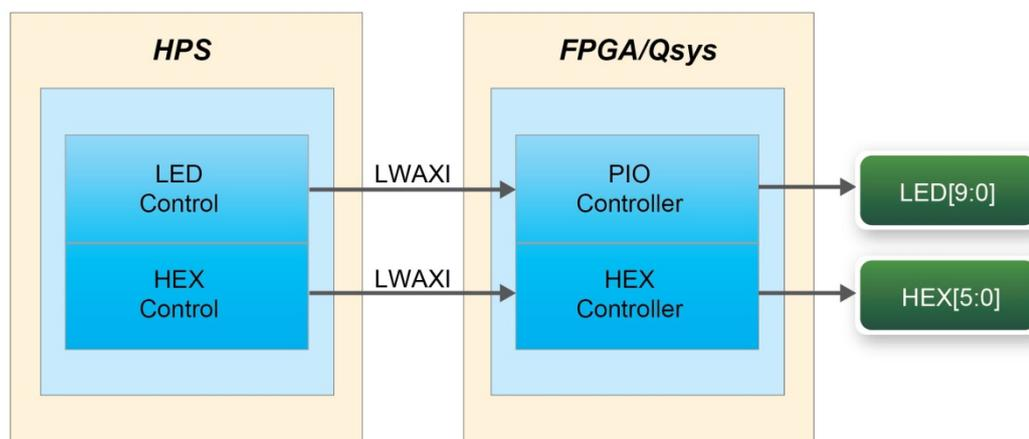
#### ■ A brief view on FPGA manager

The FPGA manager in HPS configures the FPGA fabric from HPS. It also monitors the state of FPGA and drives or samples signals to or from the FPGA fabric. The application software is provided to configure FPGA through the FPGA manager. The FPGA configuration data is stored in the file with .rbf extension. The MSEL[4:0] must be set to 01010 or 01110 before executing the application software on HPS.

#### ■ Function Block Diagram

**Figure 7-1** shows the block diagram of this demonstration. The HPS uses Lightweight HPS-to-FPGA AXI Bridge to communicate with FPGA. The hardware in FPGA part is built into

Qsys. The data transferred through Lightweight HPS-to-FPGA Bridge is converted into Avalon-MM master interface. Both PIO Controller and HEX Controller work as Avalon-MM slave in the system. They control the associated pins to change the state of LED and HEX. This is similar to a system using Nios II processor to control LED and HEX.



**Figure 7-1 FPGA LED and HEX are controlled by HPS**

## ■ LED and HEX control

The Lightweight HPS-to-FPGA Bridge is a peripheral of HPS. The software running on Linux cannot access the physical address of the HPS peripheral. The physical address must be mapped to the user space before the peripheral can be accessed. Alternatively, a customized device driver module can be added to the kernel. The entire CSR span of HPS is mapped to access various registers within that span. The mapping function and the macro defined below can be reused if any other peripherals whose physical address is also in this span.

```
#define HW_REGS_BASE ( ALT_STM_OFST )
#define HW_REGS_SPAN ( 0x04000000 )
#define HW_REGS_MASK ( HW_REGS_SPAN - 1 )
```

The start address of Lightweight HPS-to-FPGA Bridge after mapping can be retrieved by ALT\_LWFPGASLVS\_OFST, which is defined in altera\_hps hardware library. The slave IP connected to the bridge can then be accessed through the base address and the register offset in these IPs. For instance, the base address of the PIO slave IP in this system is 0x0001\_0040, the direction control register offset is 0x01, and the data register offset is 0x00. The following statement is used to retrieve the base address of PIO slave IP.

```
h2p_lw_led_addr=virtual_base+( ( unsigned long )( ALT_LWFPGASLVS_OFST
+ LED_PIO_BASE ) & ( unsigned long)( HW_REGS_MASK ) );
```

Considering this demonstration only needs to set the direction of PIO as output, which is the default direction of the PIO IP, the step above can be skipped. The following statement is used to set the output state of the PIO.

```
alt_write_word(h2p_lw_led_addr, Mask );
```

The Mask in the statement decides which bit in the data register of the PIO IP is high or low. The bits in data register decide the output state of the pins connected to the LEDs. The HEX controlling part is similar to the LED.

Since Linux supports multi-thread software, the software for this system creates two threads. One controls the LED and the other one controls the HEX. The system calls `pthread_create`, which is called in the main function to create a sub-thread, to complete the job. The program running in the sub-thread controls the LED flashing in a loop. The main-thread in the main function controls the digital shown on the HEX that keeps changing in a loop. The state of LED and HEX state change simultaneously when the FPGA is configured and the software is running on HPS.

## ■ Demonstration Source Code

- Build tool: Altera SoC EDS V13.1
- Project directory: \Demonstration\ SoC\_FPGA\HPS\_LED\_HEX
- Quick file directory:\ Demonstration\ SoC\_FPGA\HPS\_LED\_HEX\ quickfile
- FPGA configuration file : soc\_system\_dc.rbf
- Binary file: HPS\_LED\_HEX and hps\_config\_fpga
- Build app command: make ('make clean' to remove all temporal files)
- Execute app command:./hps\_config\_fpga soc\_system\_dc.rbf and./HPS\_LED\_HEX

## ■ Demonstration Setup

- Quartus II and Nios II must be installed on the host PC.
- The MSEL[4:0] is set to 01010 or 01110.
- Connect a USB cable to the USB-Blaster II connector (J13) on the DE1-SoC board and the host PC. Install the USB-Blaster II driver if necessary.
- Connect a USB cable to the USB-to-UART connector (J4) on the DE1-SoC board and the host PC.
- Copy the executable files "hps\_config\_fpga" and "HPS\_LED\_HEX", and the FPGA configuration file "soc\_system\_dc.rbf" into the microSD card under the **"/home/root"** folder in Linux.
- Insert the booting microSD card into the DE1-SoC board. Please refer to the chapter 5

"Running Linux on the DE1-SoC board" on *DE1-SoC\_Getting\_Started\_Guide.pdf* on how to build a booting microSD card image.

- Power on the DE1-SoC board.
- Launch PuTTY to establish connection to the UART port of the DE1-SoC board. Type "**root**" to login Altera Yocto Linux.
- Execute `./hps_config_fpga_soc_system_dc.rbf` in the UART terminal of PuTTY to configure the FPGA through the FPGA manager. After the configuration is successful, the message shown in **Figure 7-2** will be displayed in the terminal.

```
root@socfpga:~# ./hps_config_fpga_soc_system_dc.rbf
INFO: alt_fpga_control_enable().
INFO: alt_fpga_control_enable OK.
alt_fpga_control_enable OK next config the fpga
INFO: MSEL configured correctly for FPGA image.
soc_system_dc.rbf file file open success
INFO: FPGA Image binary at 0x72c1c008.
INFO: FPGA Image size is 2309848 bytes.
INFO: alt_fpga_configure() successful on the 1 of 5 retry(s).
INFO: alt_fpga_control_disable().
```

**Figure 7-2** Running the application to configure the FPGA

- Execute `./HPS_LED_HEX` in the UART terminal of PuTTY to start the program.
- The message shown in **Figure 7-3** will be displayed in the terminal. The LED[9:0] will be flashing and the number on the HEX[5:0] will keep changing simultaneously.

```
LED ON
hex show 8
hex show 9
hex show A
LED OFF
hex show B
hex show C
LED ON
hex show D
hex show E
LED OFF
hex show F
hex show 0
LED ON
hex show 1
hex show 2
LED OFF
hex show 3
hex show 4
hex show 5
LED ON
```

**Figure 7-3** Running result in the terminal of PuTTY

- Press "CTRL + C" to terminate the program.

## 7.2 DE1-SoC Control Panel

The DE1-SoC Control Panel is a more comprehensive example. It demonstrates:

- Control HPS LED and FPGA LED/HEX
- Query the status of buttons connected to HPS and FPGA
- Configure and query G-sensor connected to HPS
- Control Video-in and VGA-out connected to FPGA
- Control IR receiver connected to FPGA

This example not only controls the peripherals of HPS and FPGA, but also shows how to implement a GUI program on Linux. [Figure 7-4](#) [OLE LINK4](#) is the screenshot of DE1-SOC Control Panel.



**Figure 7-4 Screenshot of DE1-SoC Control Panel**

Please refer to **DE1-SoC\_Control\_Panel.pdf**, which is included in the DE1-SOC System CD for more information on how to build a GUI program step by step.

## 7.3 DE1-SoC Linux Frame Buffer Project

The DE1-SoC Linux Frame Buffer Project is an example that a VGA monitor is utilized as a standard output interface for the Linux operating system. The Quartus II project is located at this path: Demonstrations/SOC\_FPGA/DE1\_SOC\_Linux\_FB. The soc\_system.rbf file in the project is used for configuring FPGA through HPS. The .rbf file is converted from DE1\_SOC\_Linux\_FB.sof by clicking the sof\_to\_rbf.bat. The project is adopted for the following demonstrations.



- DE1\_SoC Linux Console with framebuffer
- DE1\_SoC LXDE with Desktop
- DE1\_SoC Ubuntu Desktop

The SD image file for the demonstrations above can be downloaded in the design resources for DE1-SoC at Terasic website.

These examples provide a GUI environment for further developing for the users. For example, a QT application can run on the system.



**Figure 7-5 Screenshot of DE1-SoC Linux Console with framebuffer**

Please refer to DE1-SoC\_Getting\_Started\_Guide about how to get the SD images and create a boot SD card.

## Chapter 8

# *Programming the EPCQ Device*

---

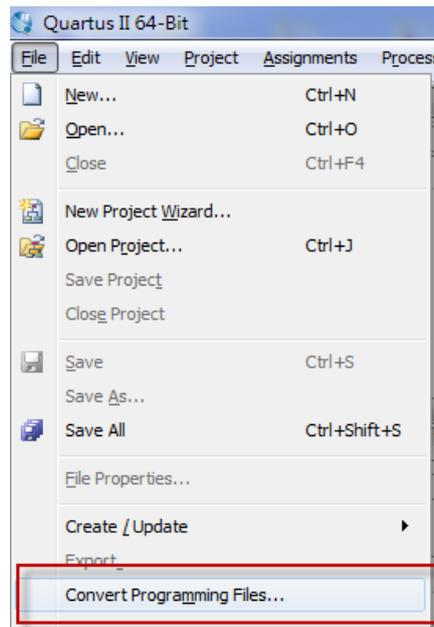
This chapter describes how to program the quad serial configuration (EPCQ) device with Serial Flash Loader (SFL) function via the JTAG interface. Users can program EPCQ devices with a JTAG indirect configuration (.jic) file, which is converted from a user-specified SRAM object file (.sof) in Quartus. The .sof file is generated after the project compilation is successful. The steps of converting .sof to .jic in Quartus II are listed below.

### 8.1 Before Programming Begins

The FPGA should be set to AS x4 mode i.e. MSEL[4..0] = “10010” to use the quad Flash as a FPGA configuration device.

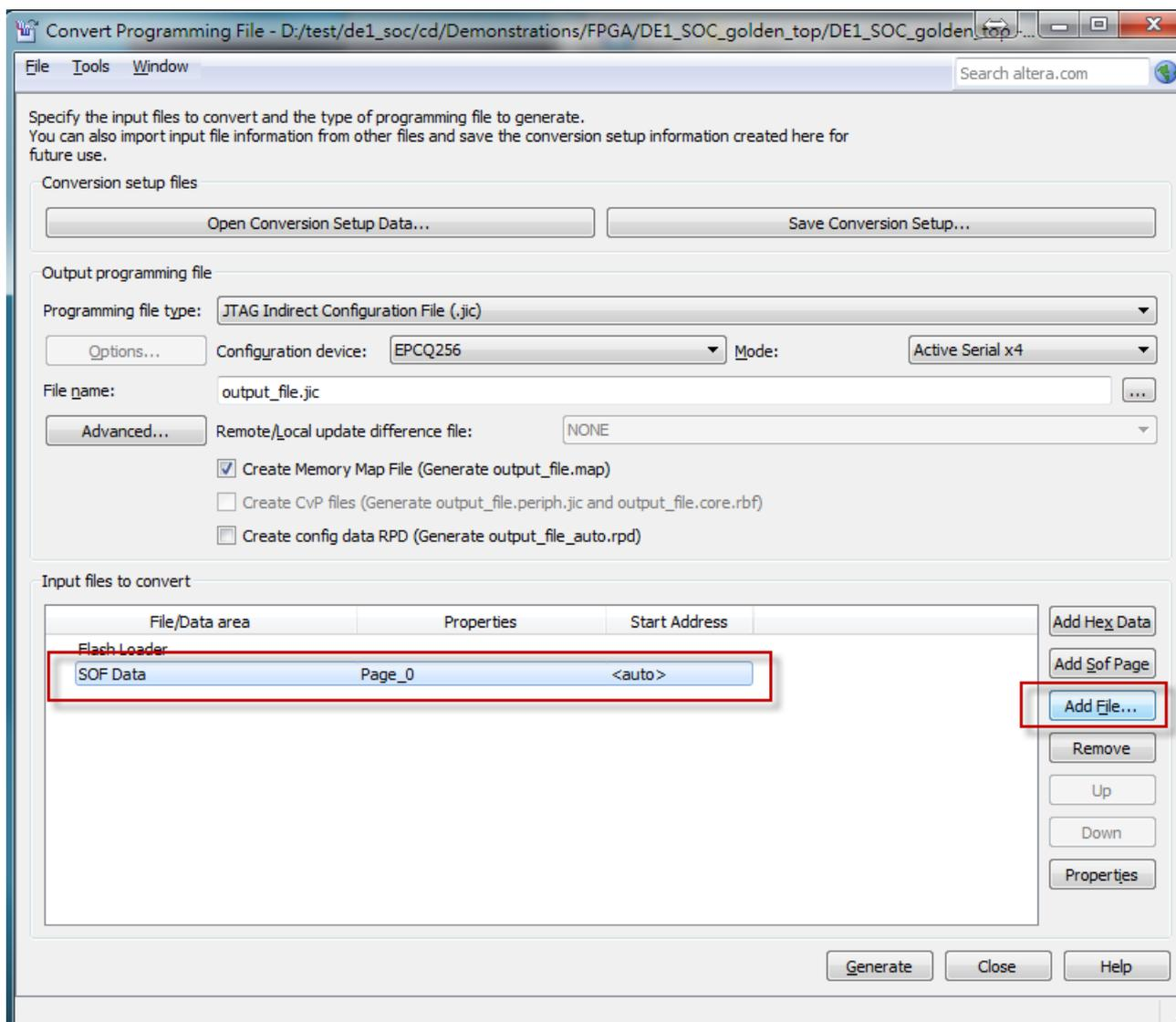
### 8.2 Convert .SOF File to .JIC File

1. Choose **Convert Programming Files** from the File menu of Quartus II, as shown in **Figure 8-1**.



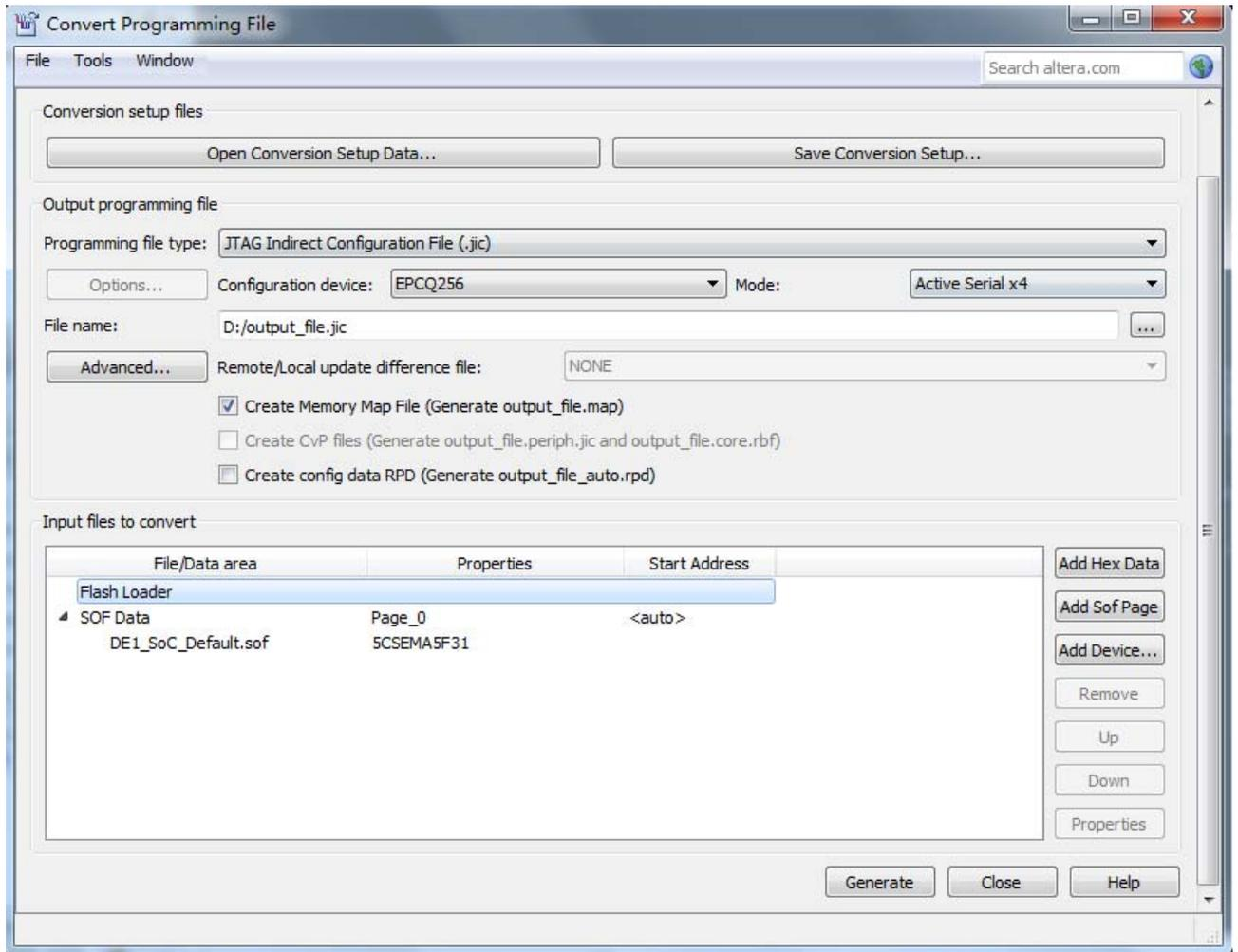
**Figure 8-1 File menu of Quartus II**

2. Select **JTAG Indirect Configuration File (.jic)** from the **Programming file type** field in the dialog of Convert Programming Files.
3. Choose **EPCQ256** from the **Configuration device** field.
4. Choose **Active Serial x4** from the **Model** field.
5. Browse to the target directory from the **File name** field and specify the name of output file.
6. Click on the **SOF data** in the section of **Input files to convert**, as shown in **Figure 8-2**.



**Figure 8-2 Dialog of “Convert Programming Files”**

7. Click **Add File**.
8. Select the .sof to be converted to a .jic file from the Open File dialog.
9. Click **Open**.
10. Click on the **Flash Loader** and click **Add Device**, as shown in **Figure 8-3**.
11. Click **OK** and the **Select Devices** page will appear.



**Figure 8-3 Click on the “Flash Loader”**

12. Select the targeted FPGA to be programmed into the EPCQ, as shown in **Figure 8-4**.
13. Click **OK** and the **Convert Programming Files** page will appear, as shown in **Figure 8-5**.
14. Click **Generate**.

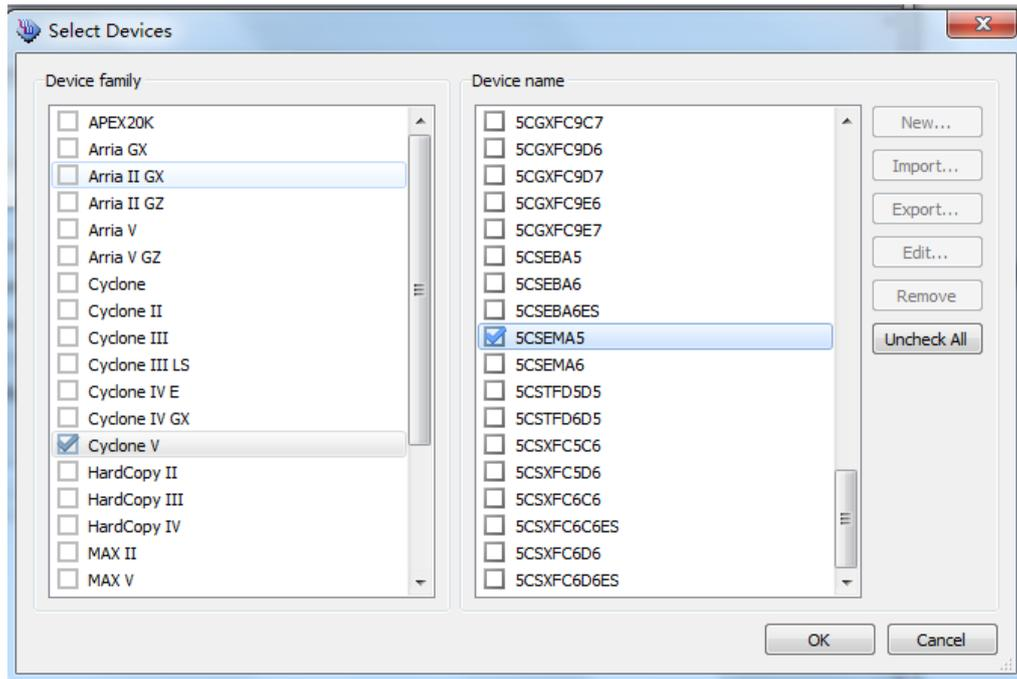


Figure 8-4 “Select Devices” page

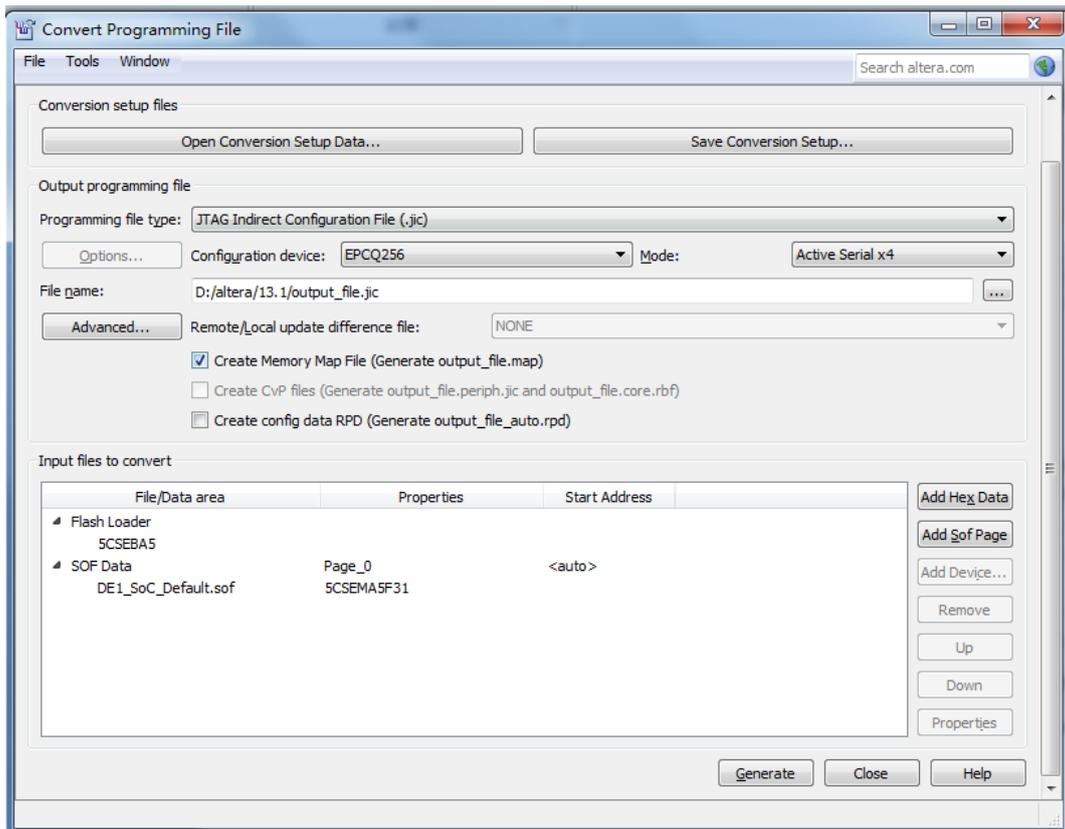
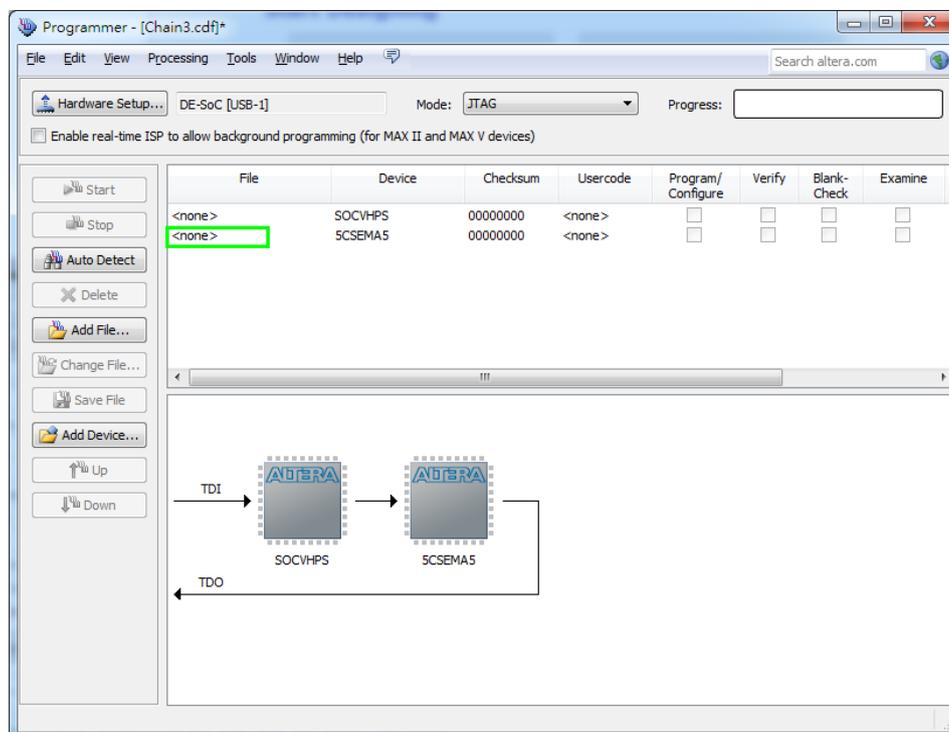


Figure 8-5 “Convert Programming Files” page after selecting the device

## 8.3 Write JIC File into the EPCQ Device

When the conversion of SOF-to-JIC file is complete, please follow the steps below to program the EPCQ device with the .jic file created in Quartus II Programmer.

1. Set MSEL[4..0] = "10010"
2. Choose **Programmer** from the Tools menu and the **Chain.cdf** window will appear.
3. Click **Auto Detect** and then select the correct device. Both FPGA device and HPS should be detected, as shown in **Figure 8-6**.
4. Double click the green rectangle region shown in **Figure 8-6** and the **Select New Programming File** page will appear. Select the .jic file to be programmed.
5. Program the EPCQ device by clicking the corresponding **Program/Configure** box. A factory default SFL image will be loaded, as shown in **Figure 8-7**.
6. Click **Start** to program the EPCQ device.



**Figure 8-6 Two devices are detected in the Quartus II Programmer**

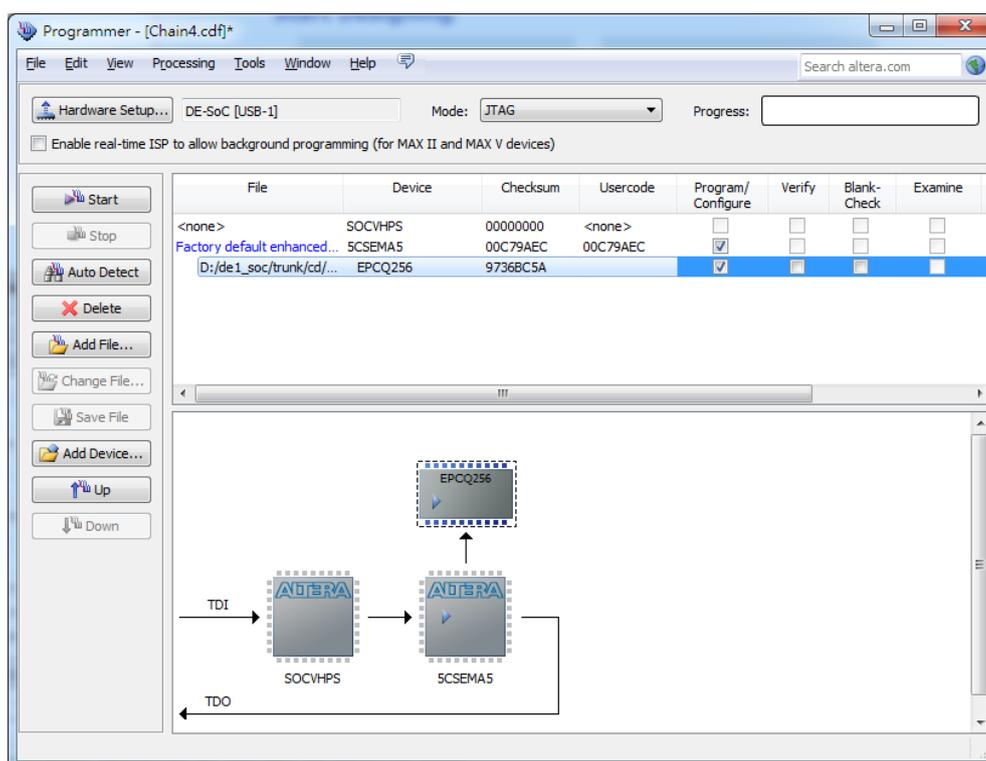


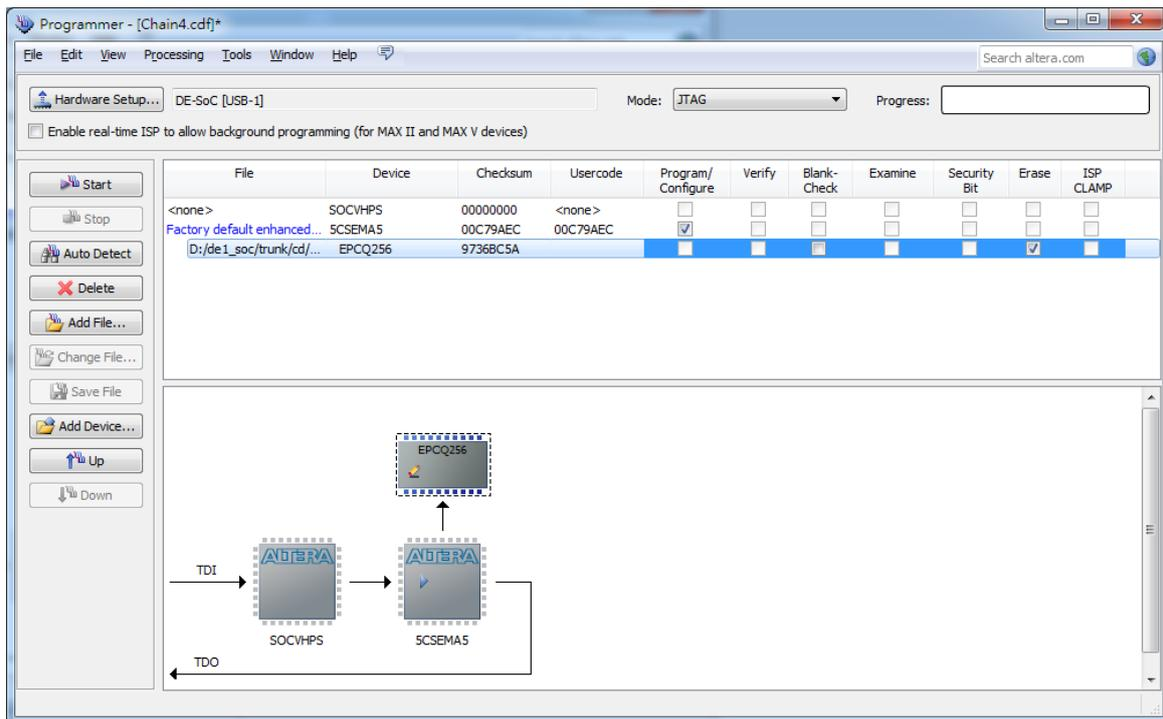
Figure 8-7 Quartus II programmer window with one .jic file

## 8.4 Erase the EPCQ Device

The steps to erase the existing file in the EPCQ device are:

1. Set MSEL[4..0] = “10010”
2. Choose **Programmer** from the **Tools** menu and the **Chain.cdf** window will appear.
3. Click **Auto Detect**, and then select correct device, both FPGA device and HPS will be detected. (See **Figure 8-6**)
4. Double click the green rectangle region shown in **Figure 8-6**, and the **Select New Programming File** page will appear. Select the correct .jic file.
5. Erase the EPCQ device by clicking the corresponding **Erase** box. A factory default SFL image will be loaded, as shown in **Figure 8-8**.





**Figure 8-8 Erase the EPCQ device in Quartus II Programmer**

6. Click **Start** to erase the EPCQ device.

## 8.5 Nios II Boot from EPCQ Device in Quartus II v13.1

There is a known problem in Quartus II software that the Quartus Programmer must be used to program the EPCQ device on DE1-SoC board.

Please refer to Altera's website [here](#) with details step by step.

### 9.1 Revision History

<i>Version</i>	<i>Change Log</i>
V0.1	Initial Version (Preliminary)
V0.2	Add Chapter 5 and Chapter 6
V0.3	Modify Chapter 3
V0.4	Add Chapter 3 HPS
V0.5	Modify Chapter 3
V1.0	Modify Chapter 8
V1.1	Modify section 3.3
V1.2	1. Add Section 7.3 2. Modify Figure 3-2
V1.2.1	Modify Figure 3-2
V1.2.2d	Modify Figure 5-5 descriptions of remote controller

Copyright © 2015 Terasic Technologies. All rights reserved.