

DETAILS

Product Number	C11814_SANDRA-12-M
Family	Sandra
Type	Lens array
Color	clear
Diameter	67 mm
Height	11,1 mm
Style	round
Optic Material	PMMA
Holder Material	
Fastening	glue, pin
Status	production ready
ROHS Compliant	Yes
Date Updated	22/04/2016



OPTICAL PROPERTIES

LED	Viewing Angle	Light Beam	Efficiency	cd/lm	Connector
XP-E	26 deg	Medium	83 %	3.000	-
XP-G	28 deg	Medium	91 %	2.500	-
NCSxx19A	27 deg	Medium	86 %	2.400	-
NVSxx19A	30 deg	Medium	86 %	2.300	-
Oslon SSL 80	28 deg	Medium	90 %	2.700	-
Z5	28 deg	Medium	-	-	-

D

C

B

A

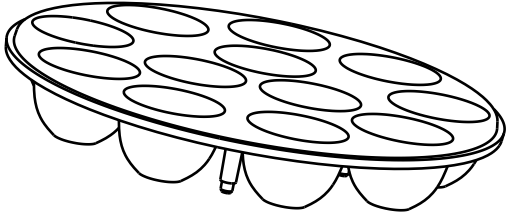

Isometric view
Scale: 1:1

4

4

3

3

2

2

1

1

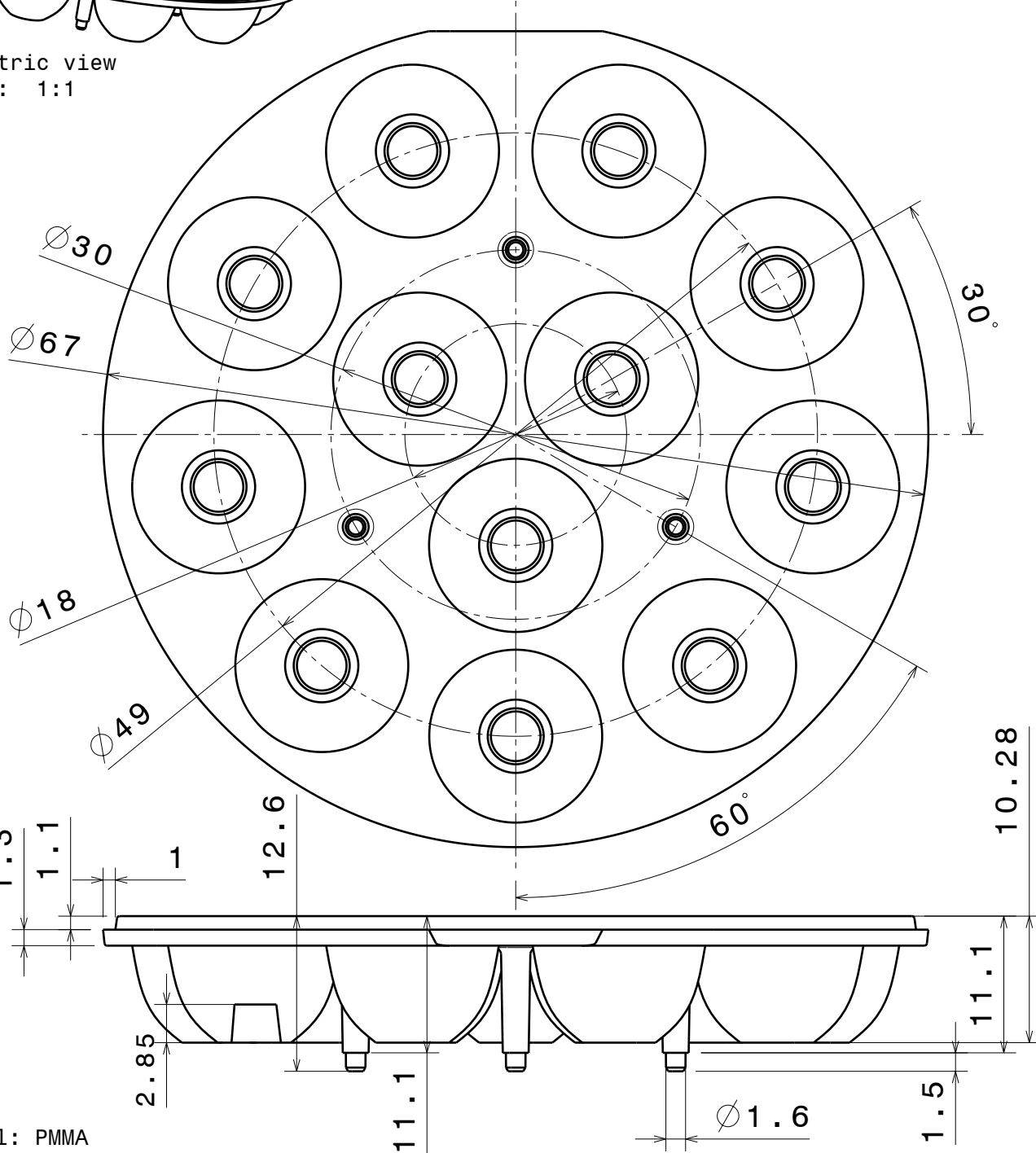

Material: PMMA

This drawing is our property.
It can't be reproduced
or communicated without
our written agreement.



Ledil Oy
Salorankatu 10
FIN-24100 SALO
Finland

DRAWING TITLE
Datasheet Sandra-12 series lens

DRAWN BY
ah
DATE
31.12.2012

CHECKED BY
DATE
SIZE
A4

DRAWING NUMBER
-
REV
1

DESIGNED BY
hh
DATE
27.08.2010

SCALE
2:1
WEIGHT (g)
SHEET
1/1

D

A

Luminaire: Ledil Oy C11814_SANDRA-12-M_(XP-E) (Cree XP-E 817lm@ 250mA) Efficiency=83%
Lamps: 1 x Cree XP-E 817lm@ 250mA

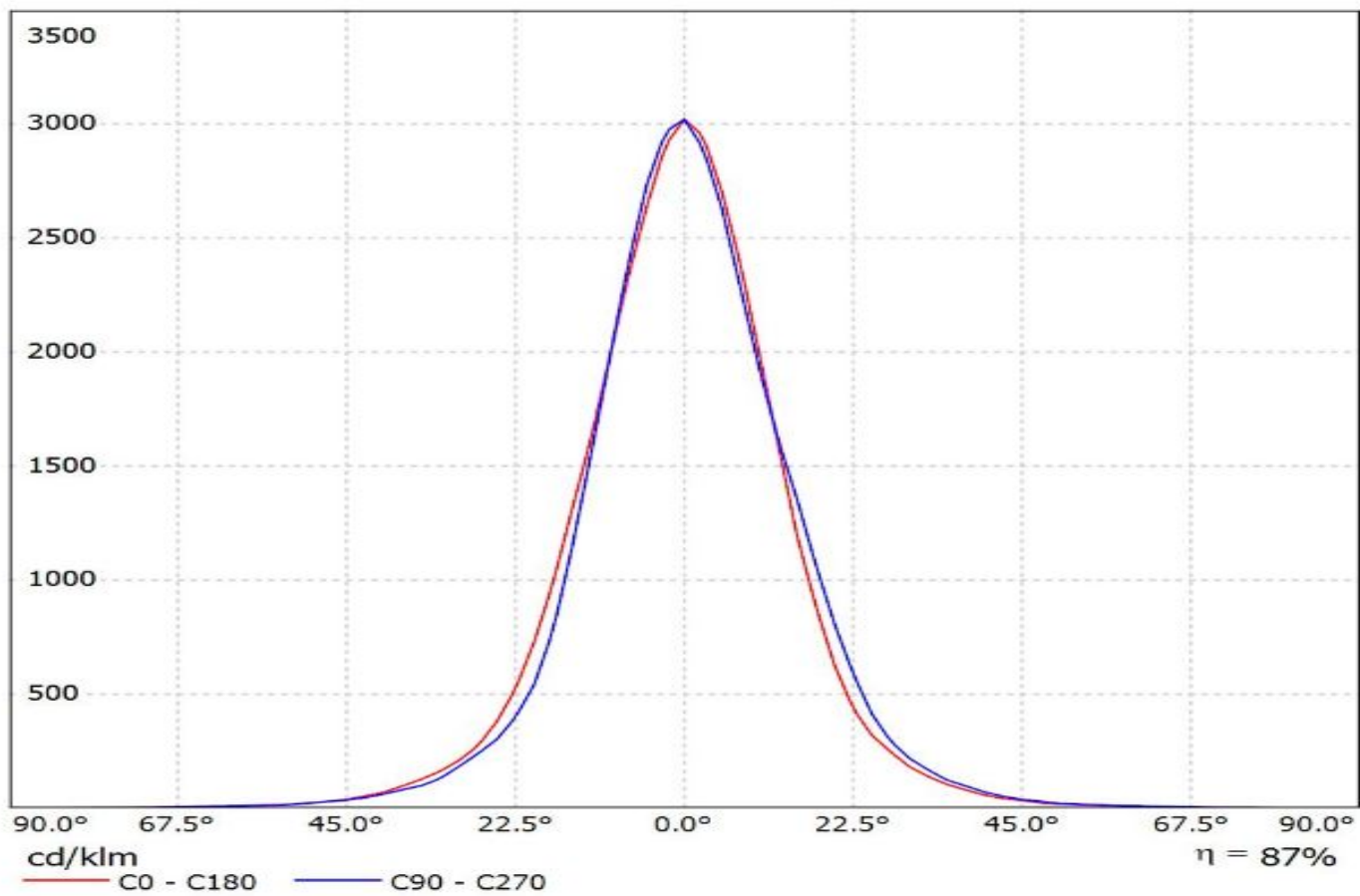

Luminaire: Ledil Oy C11814 SANDRA-12-M (Cree XP-G 1145lm @ 250mA) Efficiency=91%
Lamps: 1 x Cree XP-G 1145lm @ 250mA

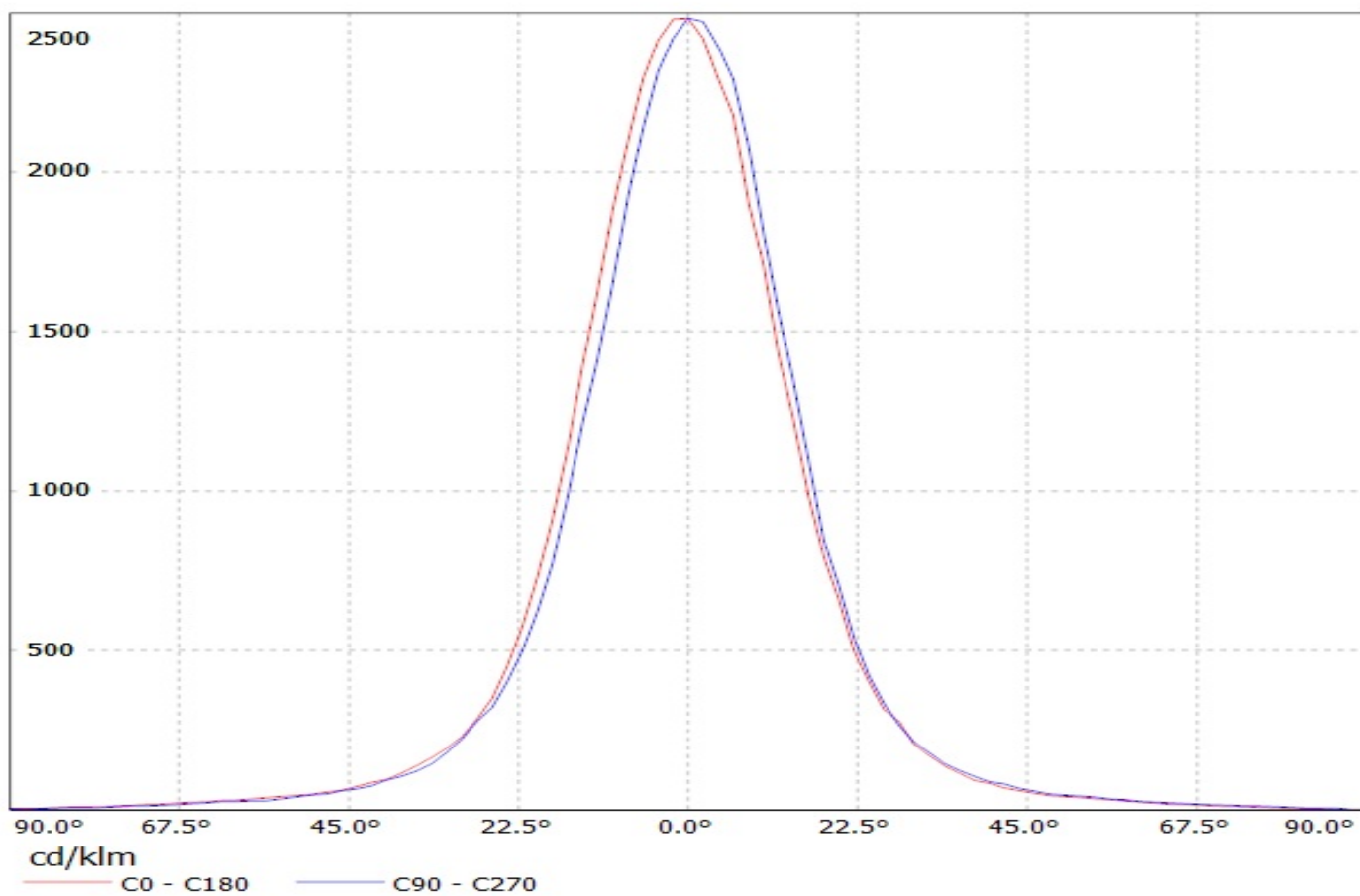

Luminaire: LEDIL OY C11814_SANDRA-12-M (NCS19) Efficiency=86%
Lamps: 1 x Nichia NCS19 (565lm@250mA)

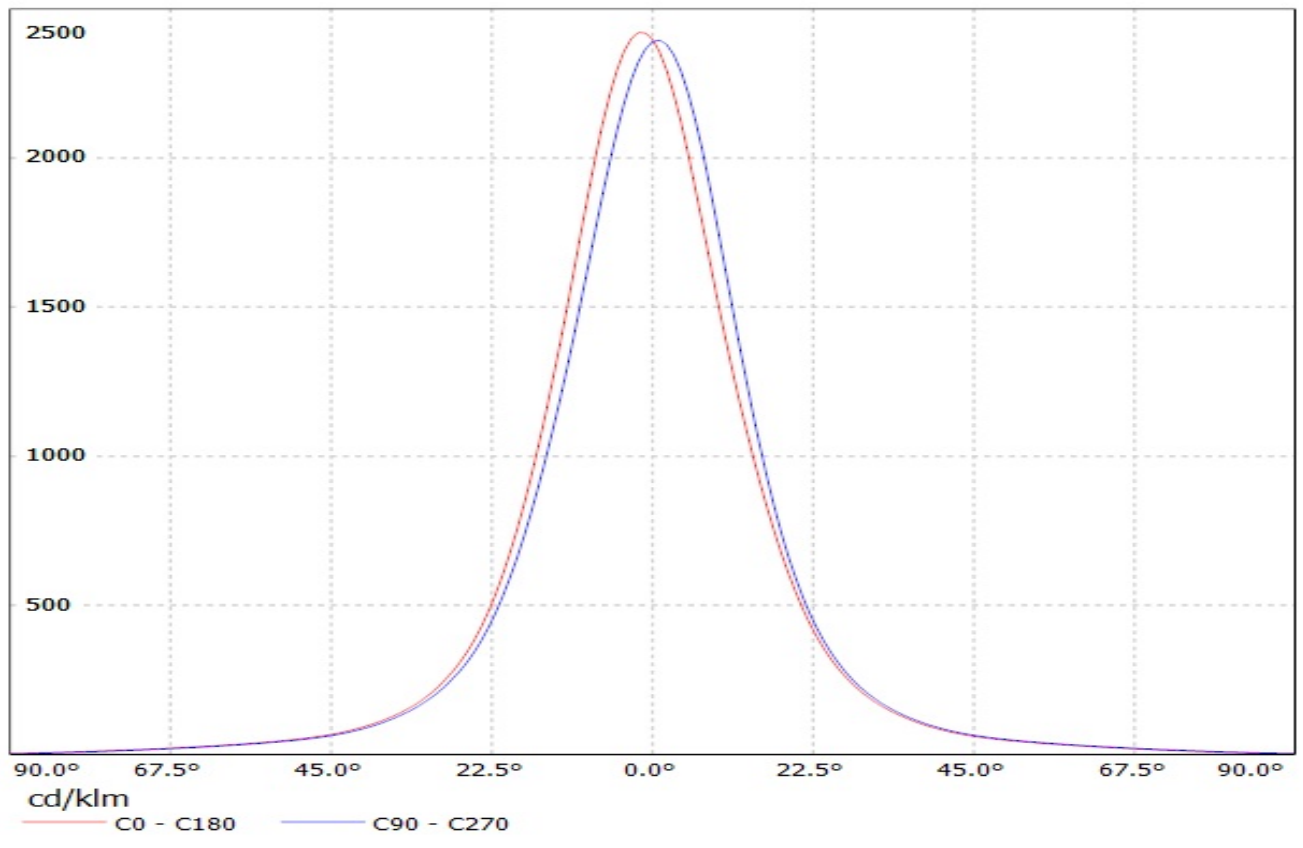

Luminaire: Ledil Oy C11814_SANDRA-12-M (Nichia NVS19 1075lm @ 250mA) Efficiency=86%
Lamps: 1 x Nichia NVS19 1075lm @ 250mA

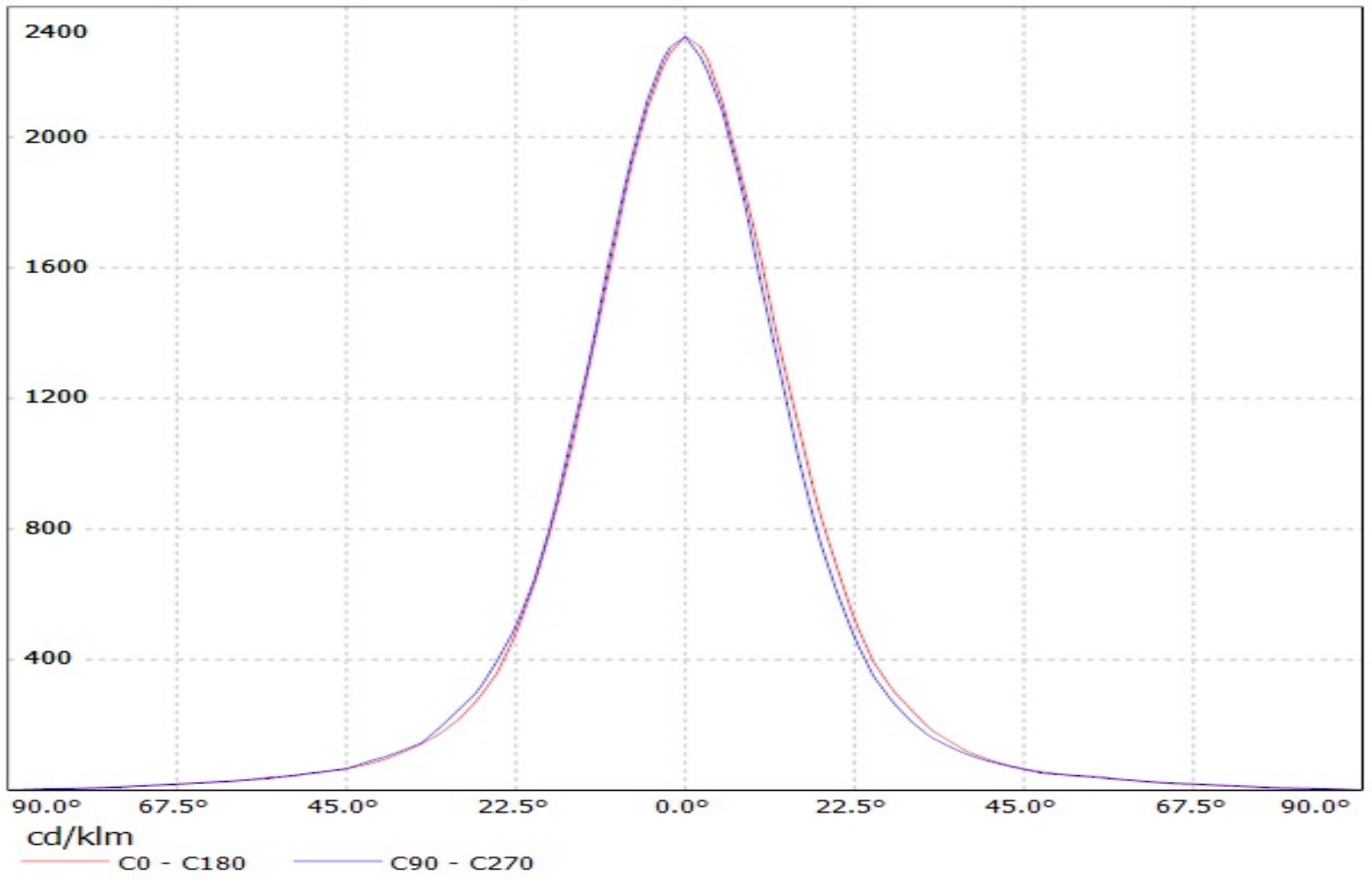

Luminaire: Ledil Oy C11814_SANDRA-12-M (Osram Oslon 80deg 968lm @ 250mA) Efficiency=90%
Lamps: 1 x Osram Oslon 80deg 968lm @ 250mA

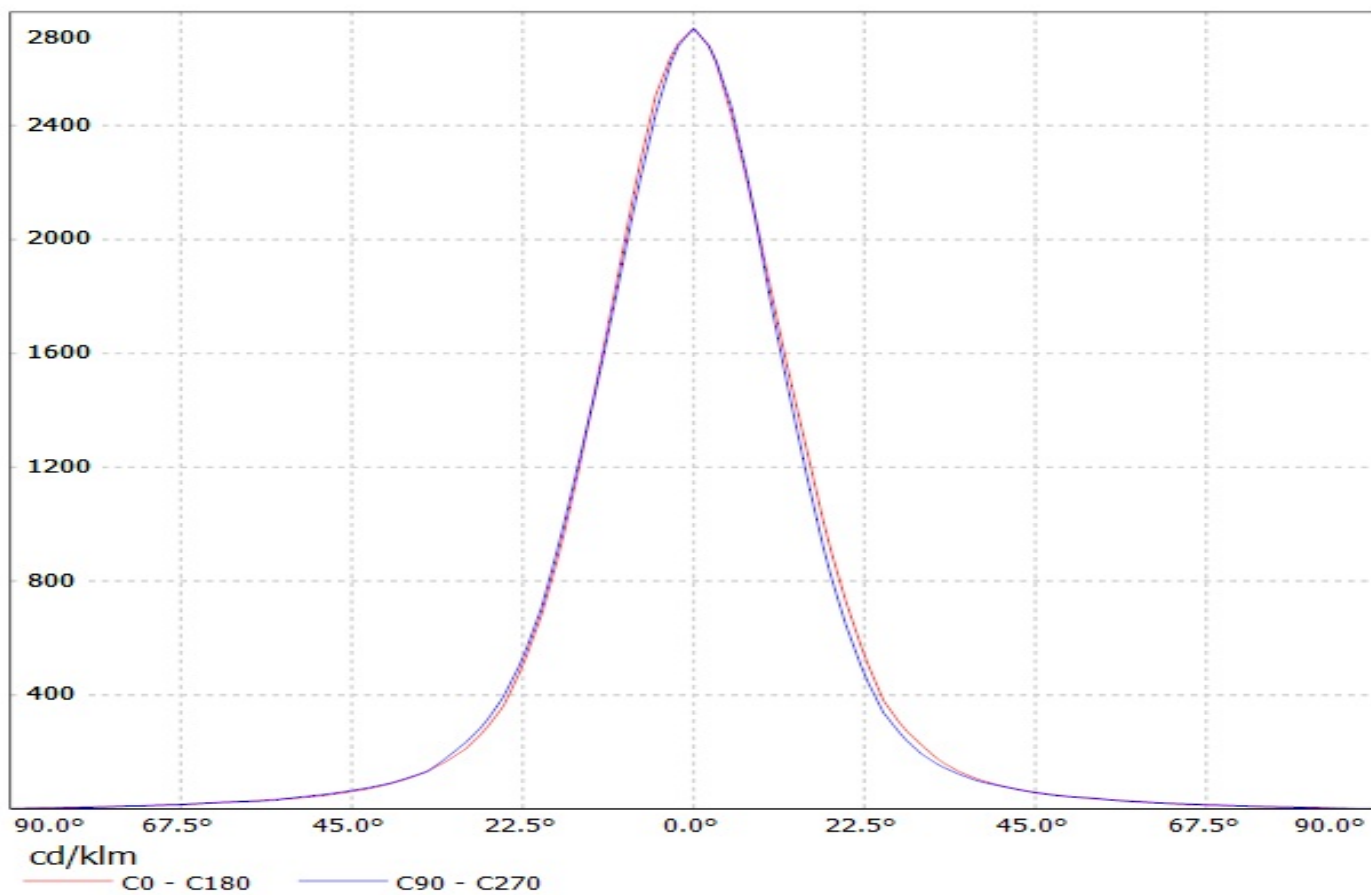

Luminaire: Ledil Oy C11814_SANDRA-12-M_(XP-E) (Cree XP-E 817lm@ 250mA) Efficiency=83%
Lamps: 1 x Cree XP-E 817lm@ 250mA

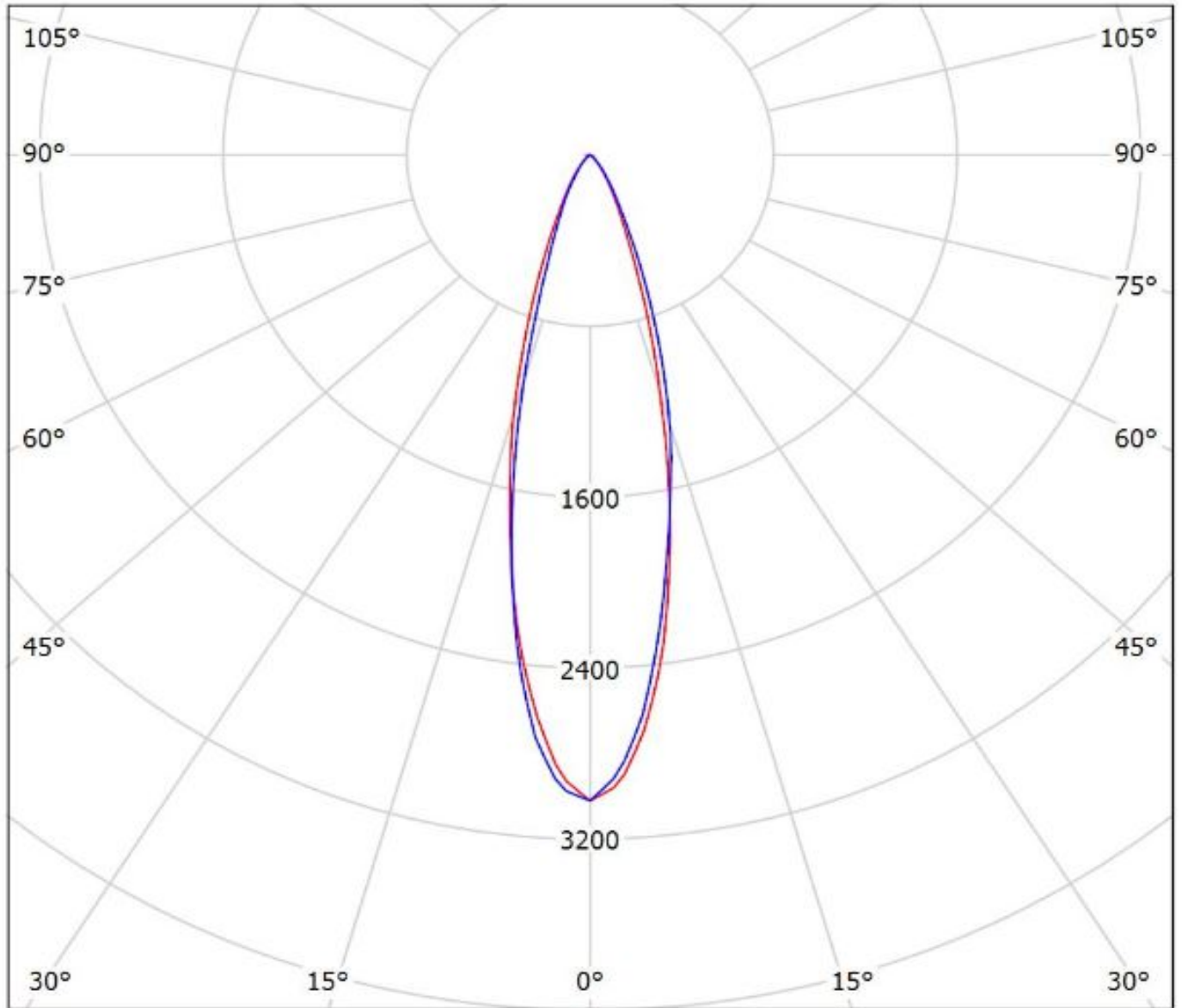

cd/klm
— C0 - C180 — C90 - C270

$\eta = 87\%$

Luminaire: Ledil Oy C11814_SANDRA-12-M (Cree XP-G 1145lm @ 250mA) Efficiency=91%
Lamps: 1 x Cree XP-G 1145lm @ 250mA

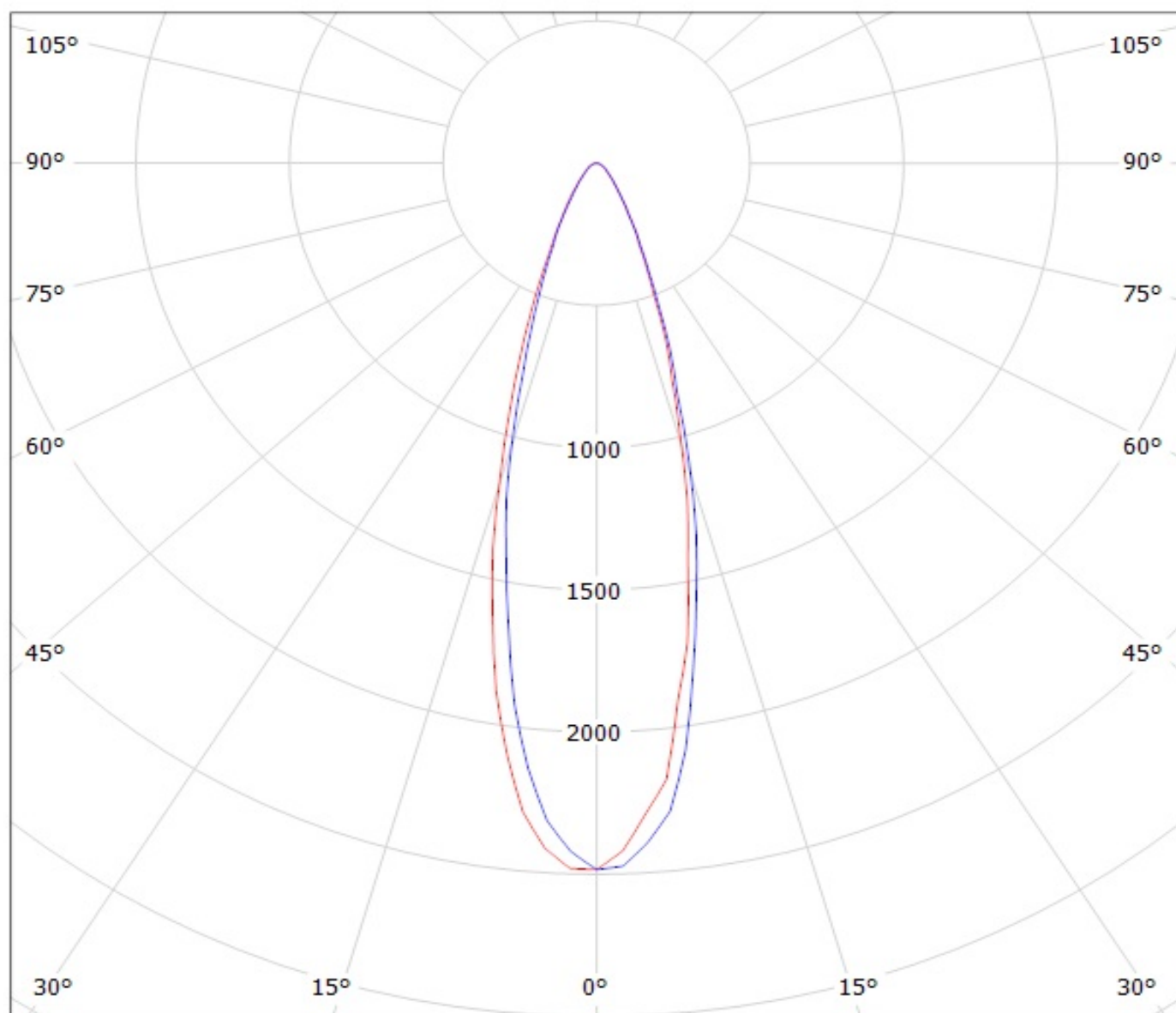

cd/klm

— C0 - C180

— C90 - C270

Luminaire: LEDIL OY C11814_SANDRA-12-M (NCS19) Efficiency=86%
Lamps: 1 x Nichia NCS19 (565lm@250mA)

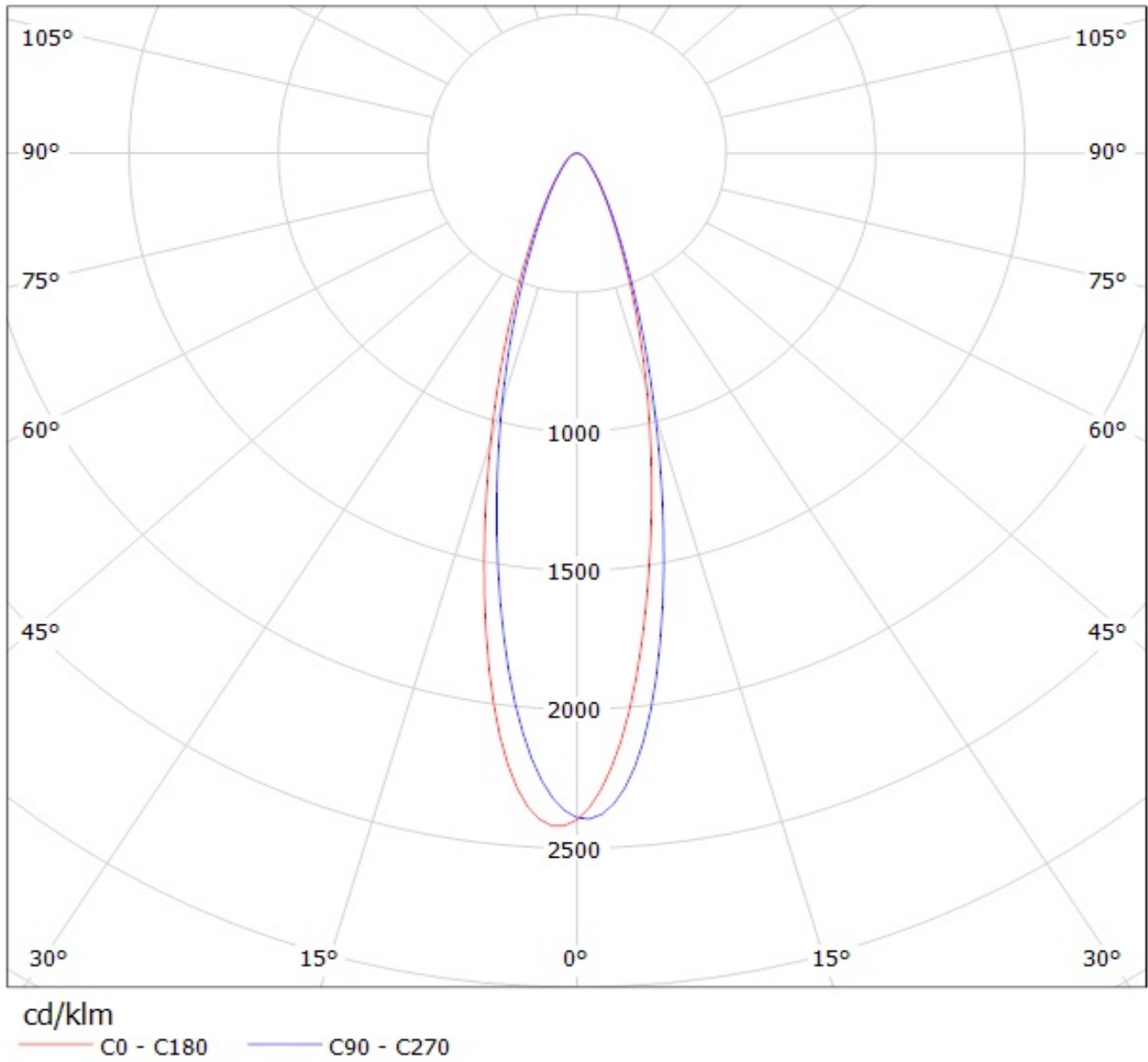

Luminaire: Ledil Oy C11814_SANDRA-12-M (Nichia NVS19 1075lm @ 250mA) Efficiency=86%
Lamps: 1 x Nichia NVS19 1075lm @ 250mA

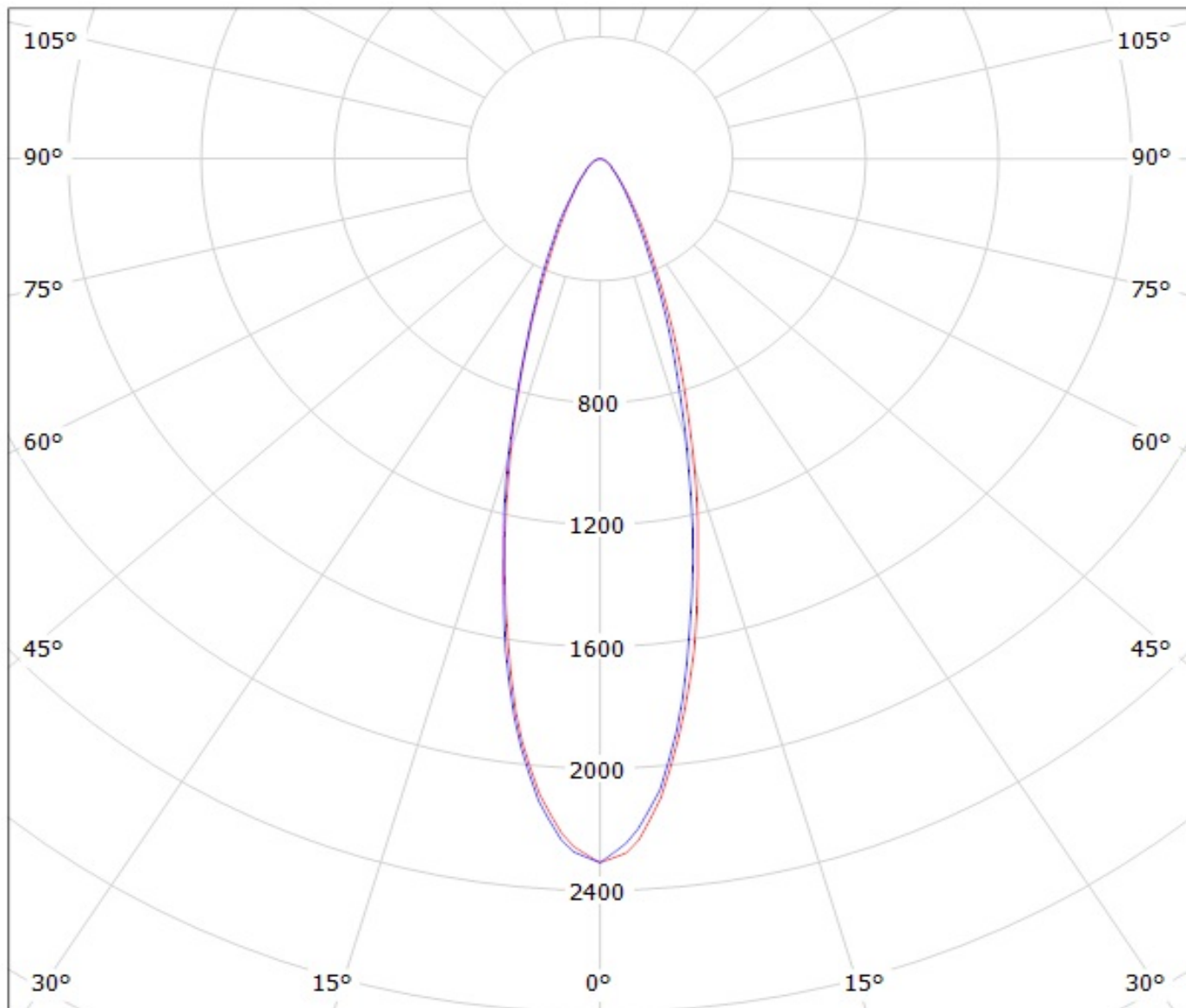

cd/klm

— C0 - C180 — C90 - C270

Luminaire: Ledil Oy C11814_SANDRA-12-M (Osram Oslon 80deg 968lm @ 250mA) Efficiency=90%
Lamps: 1 x Osram Oslon 80deg 968lm @ 250mA

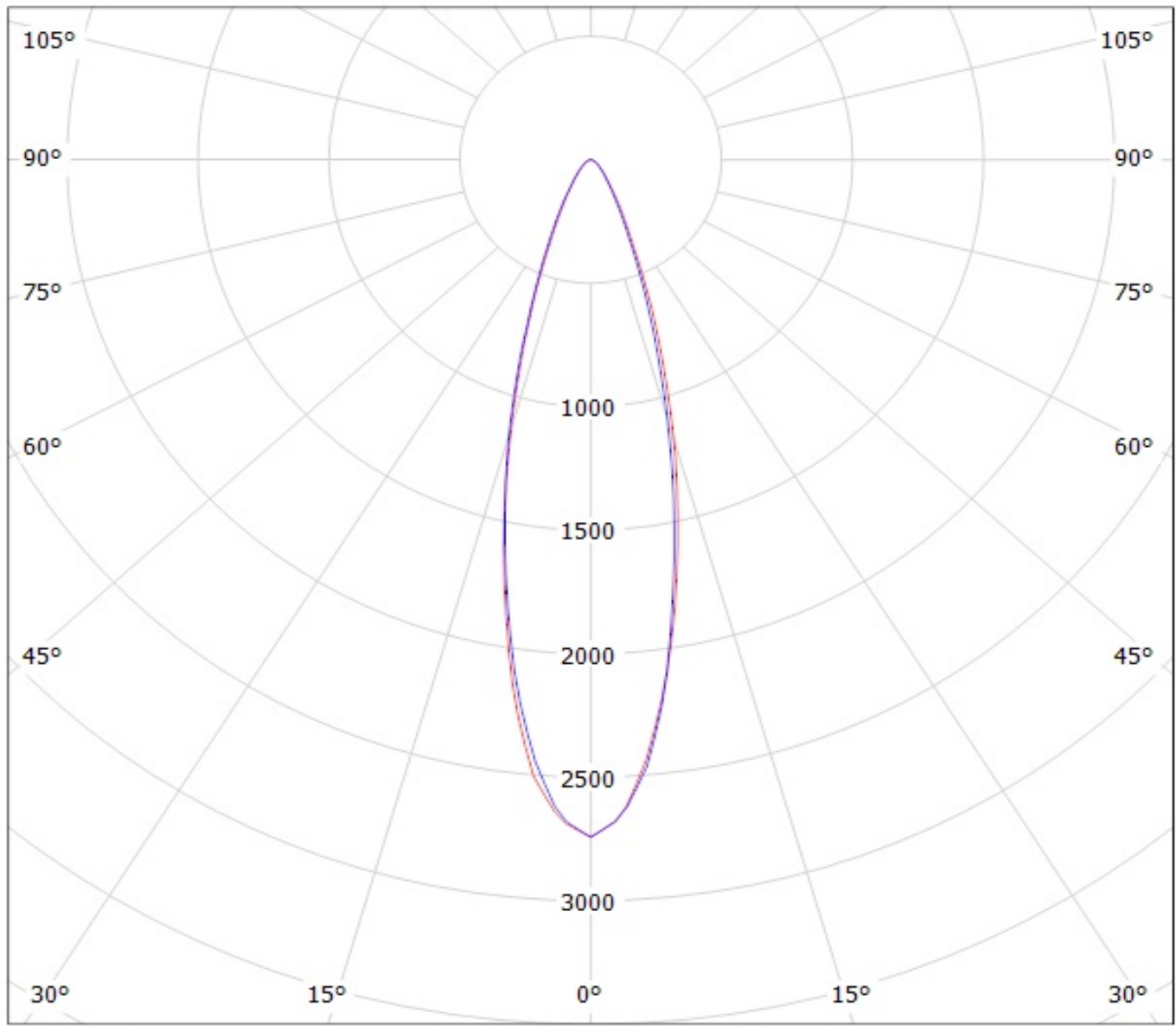

cd/klm

— C0 - C180

— C90 - C270

NOTE: The typical divergence will be changed by different color, chip size and chip position tolerance. The typical total divergence is the full angle measured where the luminous intensity is half of the peak value.