



## SMT GaAs PHEMT MMIC AMP-DOUBLER-AMP, 9 - 16 GHz OUTPUT

### Typical Applications

- Microwave Radios & VSAT
- Fiber Optic Infrastructure
- Military Communications & Radar

### Features

- Output Power: +15 dBm
- Wide Input Power Range: 0 to +10 dBm
- 100 kHz SSB Phase Noise: -140 dBc/Hz
- +5V @ 75 mA Supply
- 16 mm<sup>2</sup> Leadless QFN SMT Package

### Functional Diagram

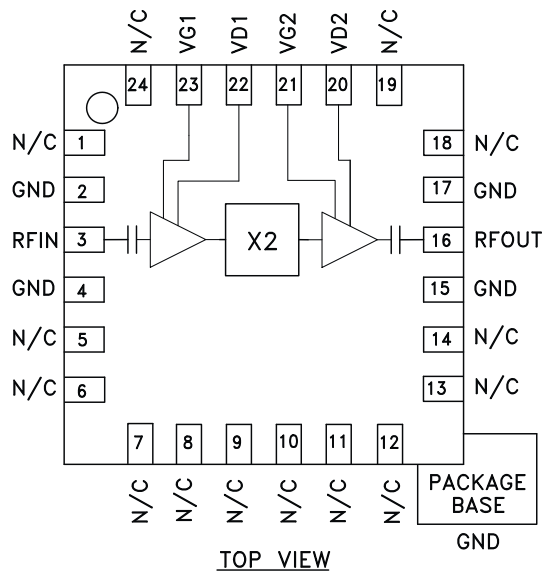

### General Description

The HMC368LP4 & HMC368LP4E are miniature amp-doubler-amps utilizing GaAs PHEMT technology in 4 x 4 mm leadless surface mount packages. When driven by a +2 dBm signal, the multiplier provides +15 dBm typical output power from 9 to 16 GHz. The Fo and the 3Fo isolations are 18 dB typical. The low additive SSB phase noise of -140 dBc/Hz at 100 kHz offset helps the user maintain good system noise performance. The HMC368LP4(E) is ideal for use in LO multiplier chains allowing reduced parts count vs. traditional approaches.

### Electrical Specifications, $T_A = +25^\circ C$ , $V_{d1} = V_{d2} = +5.0 V_{dc}$ , +2 dBm Drive Level

Parameter	Min.	Typ.	Max.	Units
Frequency Range, Input		4.5 - 8.0		GHz
Frequency Range, Output		9.0 - 16.0		GHz
Output Power	12	15		dBm
Fo Isolation (with respect to output level)		18		dB
3Fo Isolation (with respect to output level)		18		dB
Input Return Loss		10		dB
Output Return Loss		10		dB
SSB Phase Noise (Fout = 13 GHz, 100 kHz Offset)		-140		dBc/Hz
Supply Current (Idd)*		75		mA

\*Adjust Vg1, Vg2 between -2V to 0V to achieve Idd = 75 mA typical

# HMC368\* PRODUCT PAGE QUICK LINKS

Last Content Update: 02/23/2017

---

## COMPARABLE PARTS

View a parametric search of comparable parts.

## EVALUATION KITS

- HMC368LP4 Evaluation Board.

## DOCUMENTATION

### Data Sheet

- HMC368 Data Sheet

## REFERENCE MATERIALS

### Quality Documentation

- Package/Assembly Qualification Test Report: LP4, LP4B, LP4C, LP4K (QTR: 2013-00487 REV: 04)
- Semiconductor Qualification Test Report: PHEMT-F (QTR: 2013-00269)

## DESIGN RESOURCES

- HMC368 Material Declaration
- PCN-PDN Information
- Quality And Reliability
- Symbols and Footprints

## DISCUSSIONS

View all HMC368 EngineerZone Discussions.

## SAMPLE AND BUY

Visit the product page to see pricing options.

## TECHNICAL SUPPORT

Submit a technical question or find your regional support number.

## DOCUMENT FEEDBACK

Submit feedback for this data sheet.

---



**SMT GaAs PHEMT MMIC  
AMP-DOUBLER-AMP, 9 - 16 GHz OUTPUT**

**Output Power vs. Temperature @ +2 dBm Drive Level**

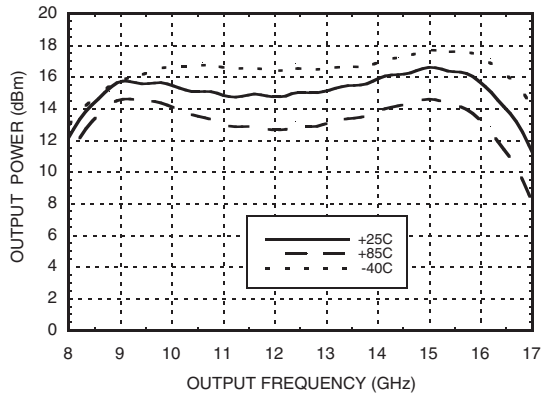

**Output Power vs. Drive Level**

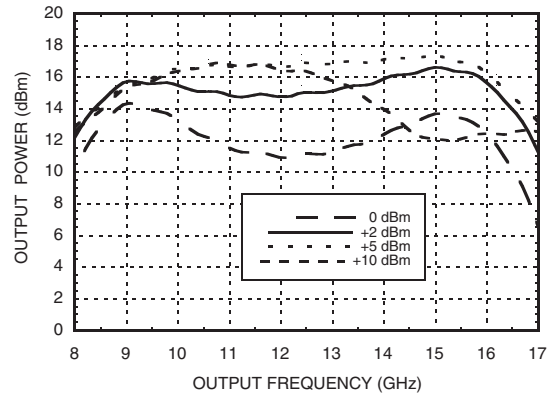

**Output Power vs. Supply Voltage @ +2 dBm Drive Level**

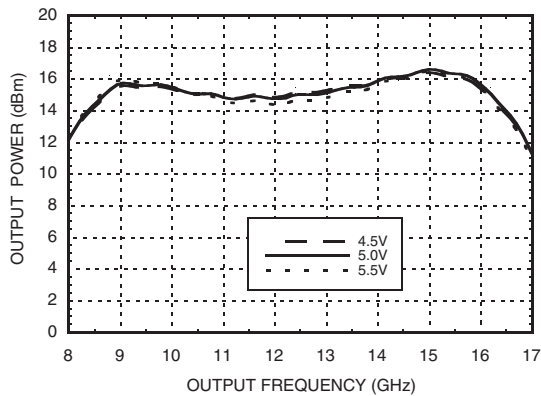

**Isolation @ +2 dBm Drive Level**

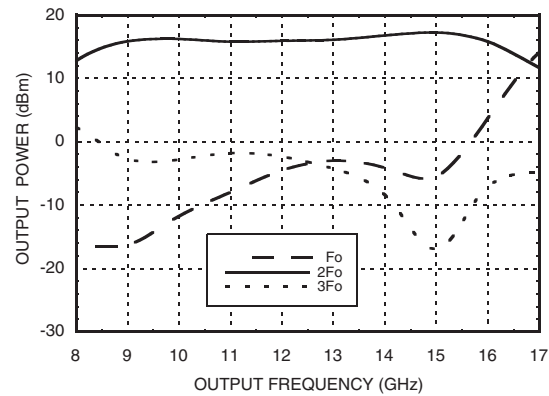

**Input Return Loss vs. Temperature**

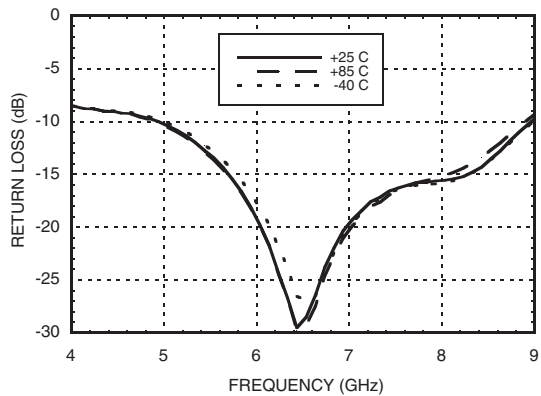

**Output Return Loss vs. Temperature**

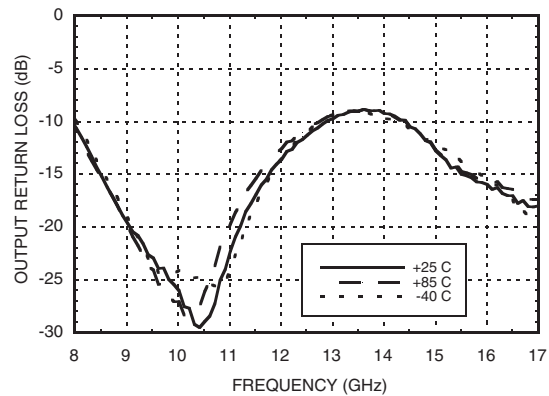

Information furnished by Analog Devices is believed to be accurate and reliable. However, no responsibility is assumed by Analog Devices for its use, nor for any infringements of patents or other rights of third parties that may result from its use. Specifications subject to change without notice. No license is granted by implication or otherwise under any patent or patent rights of Analog Devices. Trademarks and registered trademarks are the property of their respective owners.

For price, delivery, and to place orders: Analog Devices, Inc., One Technology Way, P.O. Box 9106, Norwood, MA 02062-9106 Phone: 781-329-4700 • Order online at [www.analog.com](http://www.analog.com) Application Support: Phone: 1-800-ANALOG-D



**SMT GaAs PHEMT MMIC  
AMP-DOUBLER-AMP, 9 - 16 GHz OUTPUT**

**Output Spectrum @  $F_{in} = 6.5$  GHz,  
 $P_{in} = +2$  dBm**

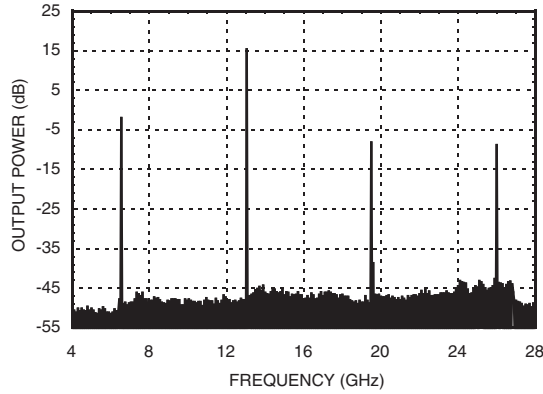

**Output Power vs. Input Power  
@ Three Frequencies**

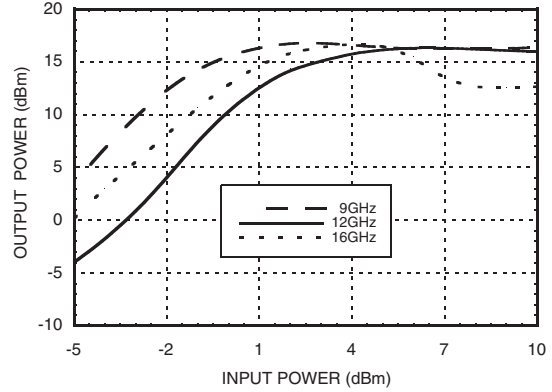

**SSB Phase Noise  
Performance,  $F_{out} = 13$  GHz,  
Input Power = +2 dBm**

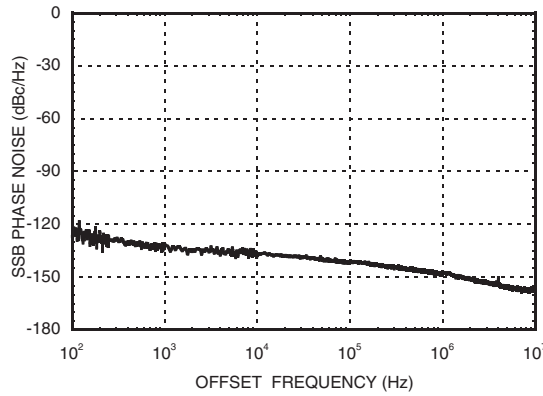

Information furnished by Analog Devices is believed to be accurate and reliable. However, no responsibility is assumed by Analog Devices for its use, nor for any infringements of patents or other rights of third parties that may result from its use. Specifications subject to change without notice. No license is granted by implication or otherwise under any patent or patent rights of Analog Devices. Trademarks and registered trademarks are the property of their respective owners.

For price, delivery, and to place orders: Analog Devices, Inc., One Technology Way, P.O. Box 9106, Norwood, MA 02062-9106 Phone: 781-329-4700 • Order online at [www.analog.com](http://www.analog.com) Application Support: Phone: 1-800-ANALOG-D



## SMT GaAs PHEMT MMIC AMP-DOUBLER-AMP, 9 - 16 GHz OUTPUT

### Absolute Maximum Ratings

RF Input (Vdd = +5V)	+20 dBm
Supply Voltage, Vd1, Vd2	+6.0V
Gate Bias Voltage (Vg1, Vg2)	-4 to 0 Vdc
Channel Temperature	150 °C
Continuous Pdiss (T = 85 °C) (derate 12.5 mW/°C above 85 °C)	812 mW
Thermal Resistance (junction to ground paddle)	80 °C/W
Storage Temperature	-65 to +150 °C
Operating Temperature	-40 to +85 °C

### Typical Supply Current vs. Vdd

Vdd (V)	Idd (mA)
4.5	73
5.0	75
5.5	77

Note: Amp-Doubler-Amp will operate over full voltage range shown above.



ELECTROSTATIC SENSITIVE DEVICE  
OBSERVE HANDLING PRECAUTIONS

### Outline Drawing

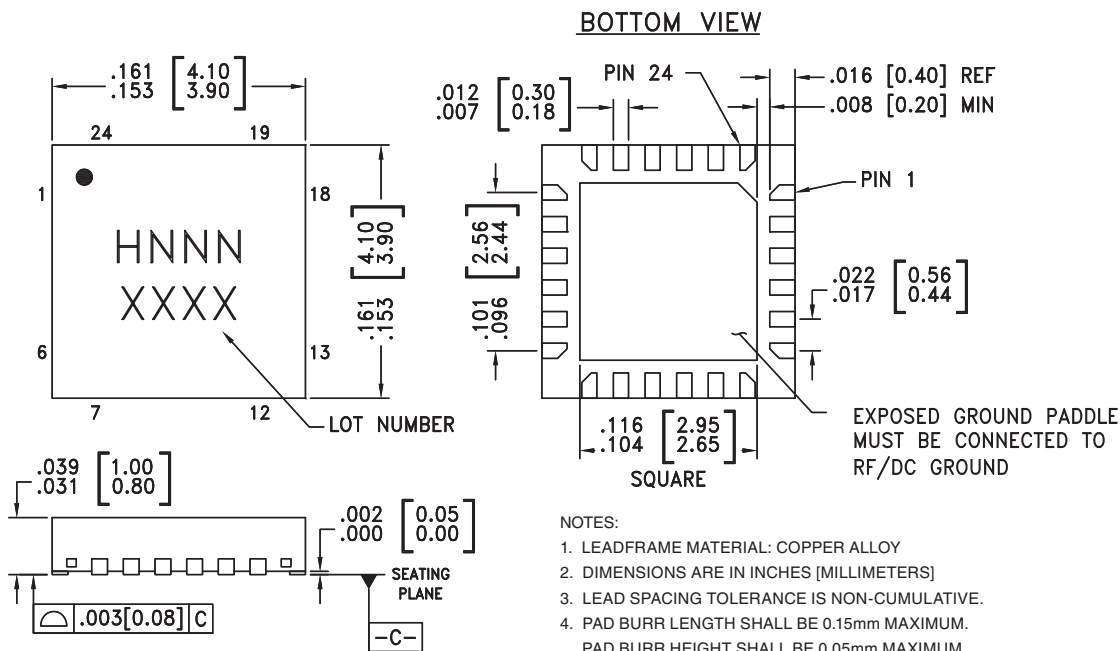

### Package Information

Part Number	Package Body Material	Lead Finish	MSL Rating	Package Marking <sup>[3]</sup>
HMC368LP4	Low Stress Injection Molding Plastic	Sn/Pb Solder	MSL1 <sup>[1]</sup>	H368 XXXX
HMC368LP4E	RoHS-compliant Low Stress Injection Molding Plastic	100% matte Sn	MSL1 <sup>[2]</sup>	H368 XXXX

[1] Max peak reflow temperature of 235 °C

[2] Max peak reflow temperature of 260 °C

[3] 4-Digit lot number XXXX

## SMT GaAs PHEMT MMIC AMP-DOUBLER-AMP, 9 - 16 GHz OUTPUT



### Pin Description

Pin Number	Function	Description	Interface Schematic
1, 5-14, 18, 19, 24	N/C	No Connection. These pins may be connected to RF ground. Performance will not be affected.	
3	RFIN	Multiplier Input. AC Coupled. No external DC blocks required.	RFIN ○ —  —
2, 4, 15, 17	GND	All ground leads and ground paddle must be soldered to PCB RF/DC ground.	○ GND ⏏
16	RFOUT	Multiplied Output. AC coupled. No external DC blocks necessary.	—  — ○ RFOUT
20, 22	Vd2, Vd1	Drain supply voltage 5V ± 0.5V.	○ Vd1, Vd2 ⏏
21, 23	Vg2, Vg1	Gate supply voltages. Adjust between -2 Vdc to 0 Vdc to achieve 75 mA drain current.	○ Vg1, Vg2 ⏏



**Evaluation PCB**

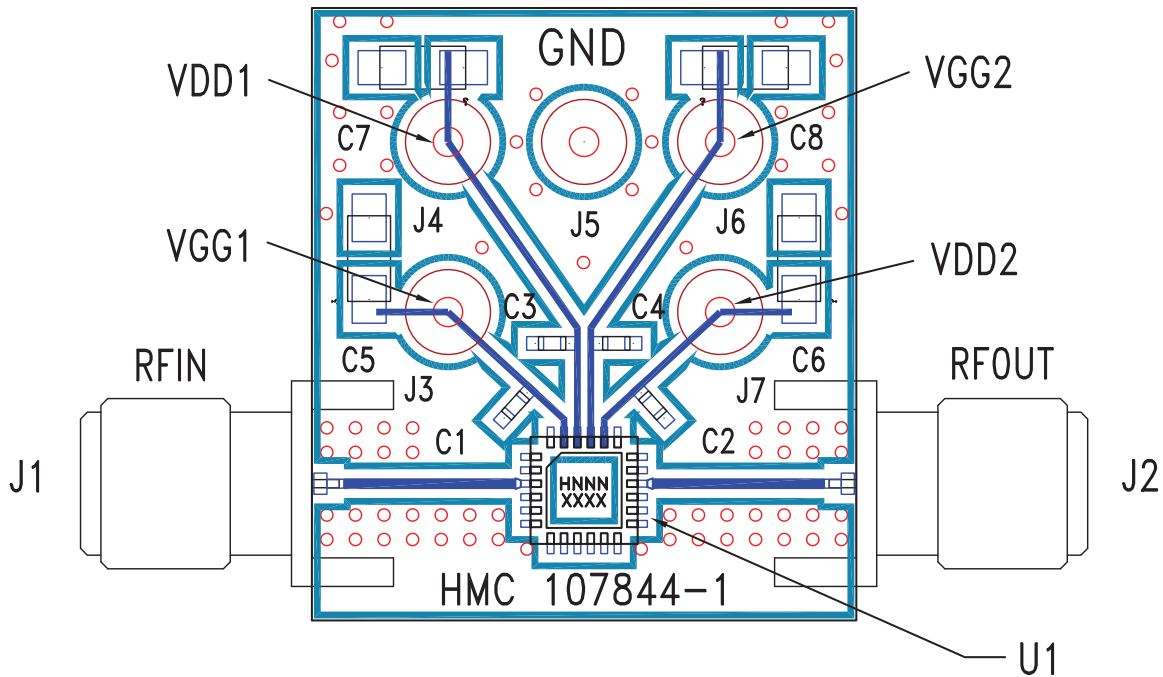

**List of Materials for Evaluation PCB 107846 [1]**

Item	Description
J1 - J2	PCB Mount SMA Connector
J3 - J7	DC Pin
C1 - C4	100 pF capacitor, 0402 Pkg.
C5 - C8	2.2 μF capacitor, case size A
U1	HMC368LP4 / HMC368LP4E Amp-x2-Amp
PCB [2]	107844 PCB

[1] Reference this number when ordering complete evaluation PCB

[2] Circuit Board Material: Rogers 4350

The circuit board used in the final application should be generated with proper RF circuit design techniques. Signal lines should have 50 ohm impedance while the package ground leads and exposed paddle should be connected directly to the ground plane similar to that shown. The evaluation circuit board shown is available from Hittite upon request.