

Front plate - VS-SI-FP-DSUB9-DSUB15 - 1656576

Please be informed that the data shown in this PDF Document is generated from our Online Catalog. Please find the complete data in the user's documentation. Our General Terms of Use for Downloads are valid (<http://download.phoenixcontact.com>)



Data front plate, plastic, for 1 x 15-pos. D-SUB and 1 x 15-pos. D-SUB, item 1656961 may be required for mounting D-SUB inserts



Key commercial data

| | |
|--------------------------------------|----------|
| Packing unit | 1 pc |
| Weight per Piece (excluding packing) | 21.1 GRM |
| Custom tariff number | 85389099 |
| Country of origin | Germany |

Technical data

Ambient conditions

| | |
|---------------------------------|------------------|
| Ambient temperature (operation) | -10 °C ... 60 °C |
|---------------------------------|------------------|

General

| | |
|---|------|
| Color | gray |
| Housing material | PBT |
| Inflammability class according to UL 94 | V0 |

Classifications

eCl@ss

| | |
|------------|----------|
| eCl@ss 4.0 | 27140816 |
| eCl@ss 4.1 | 27140816 |
| eCl@ss 5.0 | 27189239 |
| eCl@ss 5.1 | 27189239 |
| eCl@ss 6.0 | 27144001 |
| eCl@ss 7.0 | 27144001 |

Front plate - VS-SI-FP-DSUB9-DSUB15 - 1656576

Classifications

eCl@ss

| | |
|------------|----------|
| eCl@ss 8.0 | 27144001 |
|------------|----------|

ETIM

| | |
|----------|----------|
| ETIM 2.0 | EC000007 |
| ETIM 3.0 | EC000007 |
| ETIM 4.0 | EC000007 |
| ETIM 5.0 | EC000456 |

UNSPSC

| | |
|---------------|----------|
| UNSPSC 6.01 | 31261501 |
| UNSPSC 7.0901 | 31261501 |
| UNSPSC 11 | 31261501 |
| UNSPSC 12.01 | 31261501 |
| UNSPSC 13.2 | 31261501 |

Accessories

Accessories

Marking material

Marker labels - VS-SI-BZ - 1656660



Marker label, plastic, plate with 20 labels

Mounting set - VS-SI-SCREW-GC - 1656961



Mounting set, for DSUB gender changer contact inserts

Drawings

Front plate - VS-SI-FP-DSUB9-DSUB15 - 1656576

Dimensioned drawing

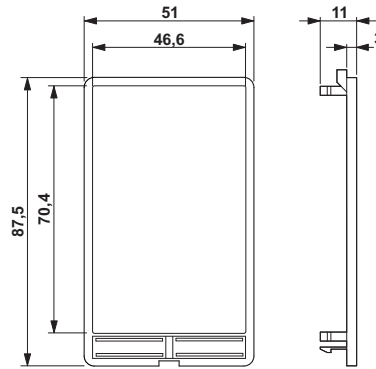

Front plate