

411D Laser Distance Meter Quick Reference Guide

Safety

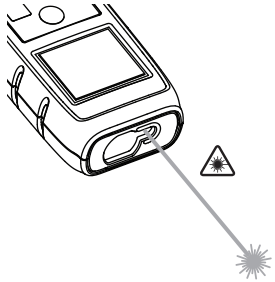

CAUTION

LASER RADIATION
DO NOT STARE INTO BEAM
CLASS II (2) LASER PRODUCT

OUTPUT: $\leq 1\text{ mW}$
WAVELENGTH: 620-690 nm
COMPLIES WITH: FDA 21CFR 1040.10.11
AND EN60825-1:07

2 AAA
NEDA 24A
IEC LR03

FLUKE CORPORATION
EVERETT, WA
www.fluke.com

On/Off

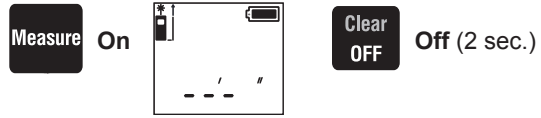

Batteries

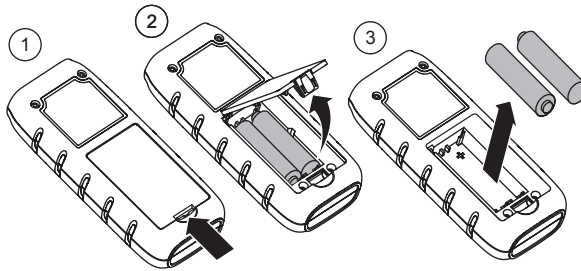

Adjust Plane

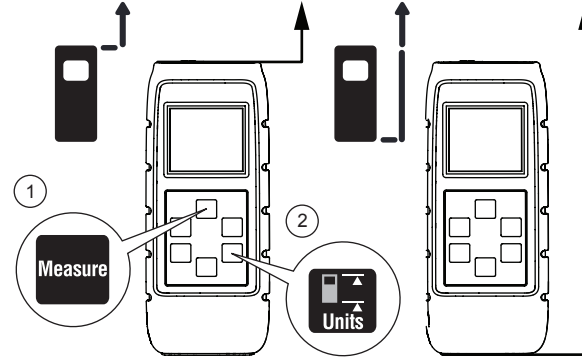

Adjust Units

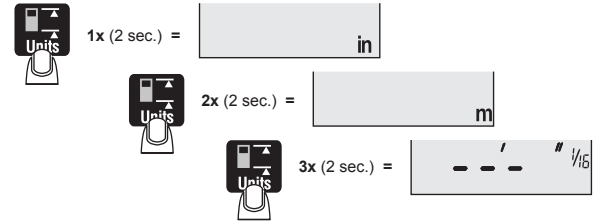

Select Measurement

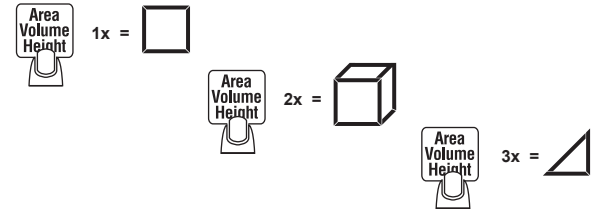

Display / Keypad

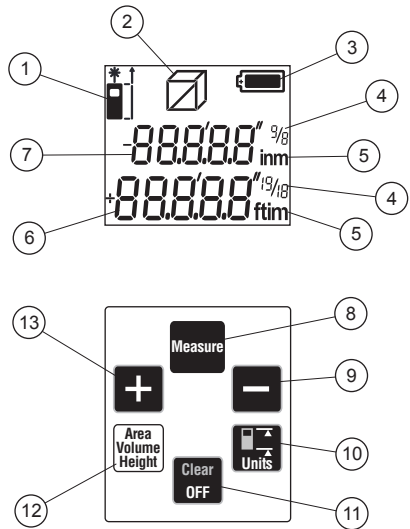

	English	Français	Deutsch	Español	Português	简体中文
①	Measuring plane	Plan	Messebene	Plano de medición	Plano de medição	测量面
②	Distance / area / volume / height	Distance/aire/volume/hauteur	Entfernung / Fläche / Volumen / Höhe	Distancia / superficie / volumen / altura	Distância / área / volume / altura	距离 / 面积 / 体积 / 高度
③	Batteries	Piles	Batterien	Baterías	Baterias	电池
④	Fractions / exponents	Fractions/exposants	Brüche / Exponenten	Fracciones / exponentes	Fracções / expoentes	分数/指数
⑤	Units	Unités	Einheiten	Unidades	Unidades	单位
⑥	Summary row (primary display)	Ligne de résumé (premier affichage)	Zusammenfassungszeile (primäre Anzeige)	Hilera de resumen (pantalla principal)	Fila de resumo (monitor principal)	摘要行 (主要显示)
⑦	2 nd row (secondary display)	2e ligne (affichage secondaire)	2. Zeile (sekundäre Anzeige)	2da hilera (pantalla secundaria)	2a fila (monitor secundário)	第 2 行 (辅助显示)
⑧	On / measure	En marche/mesurer	An / Messen	Encendido / medir	Ligar / medida	开 / 测量
⑨	Subtraction	Soustraction	Subtraktion	Resta	Subtração	减
⑩	Measuring plane / unit	Plan/unité de mesure	Messebene / Einheit	Plano de medición / unidad	Plano de medição / unidade	测量面 / 单位
⑪	Clear / off	Effacer/arrêt	Löschen / Aus	Borrar / apagado	Limpar / desligar	清除 / 关
⑫	Distance / area / volume / height	Distance/aire/volume/hauteur	Entfernung / Fläche / Volumen / Höhe	Distancia / superficie / volumen / altura	Distância / área / volume / altura	距离 / 面积 / 体积 / 高度
⑬	Addition	Addition	Addition	Suma	Adição	加

Distance

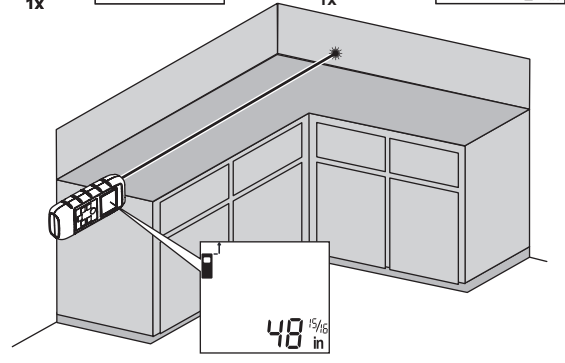
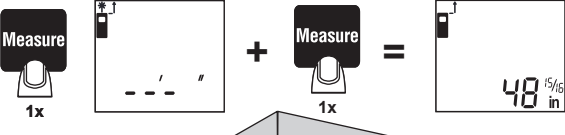
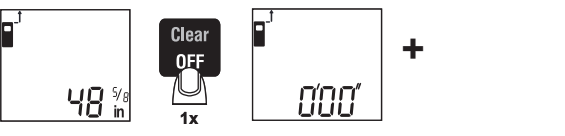
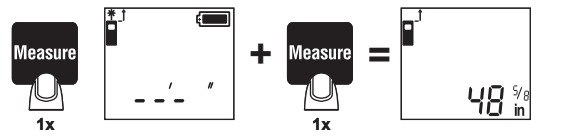

Area

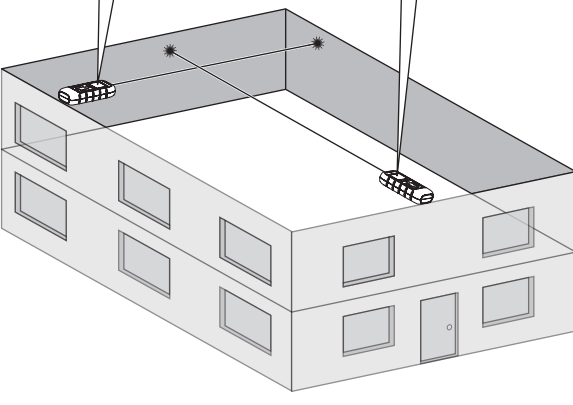
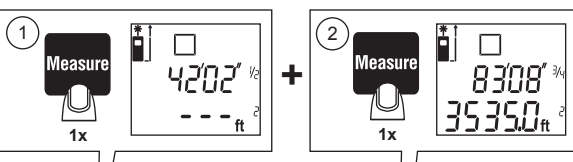
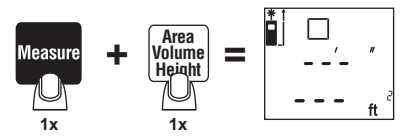

Volume

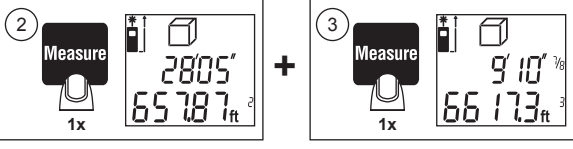
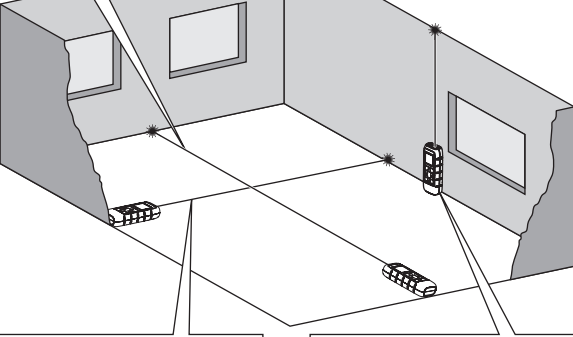
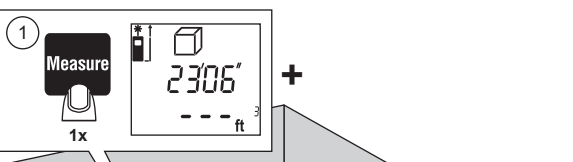
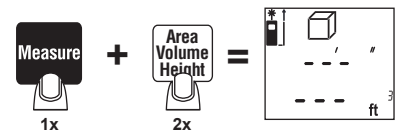

Height

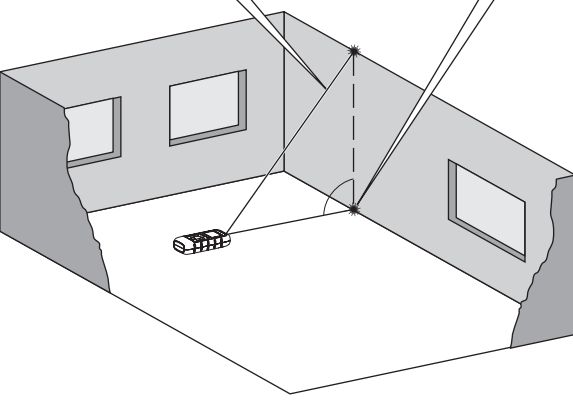
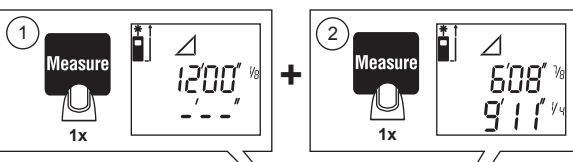
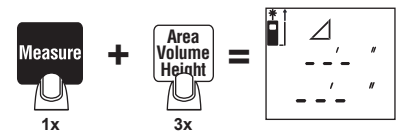

+ Add

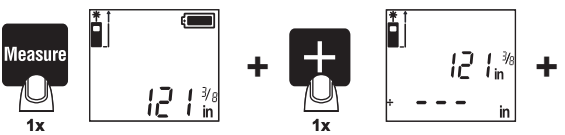

- Subtract

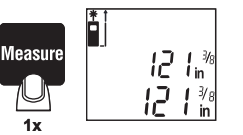

Continuous

