



**PART No. EN4SD202410LG**

for more information visit  
[www.hammfg.com](http://www.hammfg.com)

Data subject to change without notice

Isometric drawing Not to Scale



**TOP VIEW**

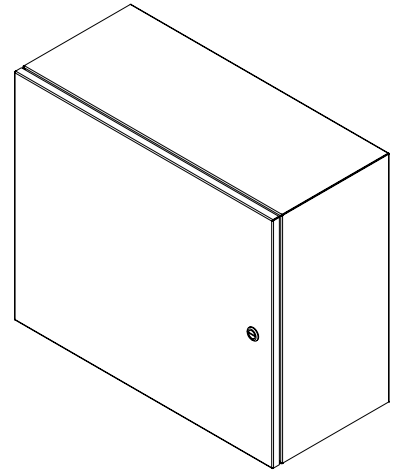

**ISOMETRIC VIEW**

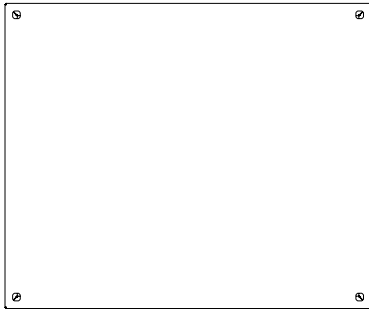

**BACK VIEW**

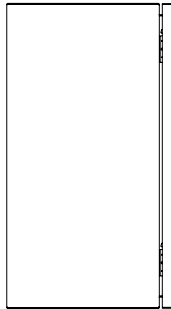

**LEFT SIDE VIEW**

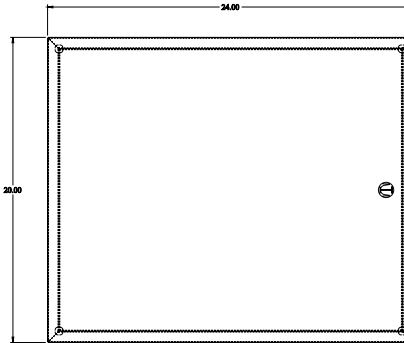

**FRONT VIEW**

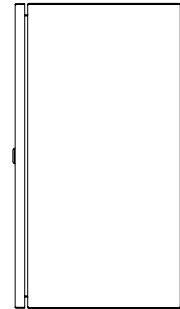

**RIGHT SIDE VIEW**



**BOTTOM VIEW**