

# 6000 series

## Toggle switches for military applications

*Distinctive features and specifications*



- Suitable for military or industrial applications
- Sealing and locking lever options available
- Matt black finish on actuator and bushing

### ELECTRICAL SPECIFICATIONS

- Max. current/voltage rating : see table below
- Initial contact resistance : 10 mΩ max.
- Insulation resistance : 1.000 MΩ min. at 500VDC
- Dielectric strength :  
2.000 Vrms 50 Hz min. between terminals  
3.000 Vrms 50 Hz min. between terminals and frame
- Electrical life : 10.000 cycles at full load

| CURRENT/VOLTAGE RATING |       |
|------------------------|-------|
|                        | 30VDC |
| Resistive load         | 6,5A  |
| Inductive load         | 5A    |
| Lamp load              | 3A    |

### MATERIALS

- Case : diallyphthalate (DAP)
- Actuator : brass, chrome plated, black
- Bushing : brass, chrome plated, black
- Contacts : A : silver

### GENERAL SPECIFICATIONS

- Torque : 1,50 Nm (1.10 Ft.lb) max. applied to nut
- Panel thickness : 5 mm (.196) max.
- Operating temperature : -40°C to +85°C

### ABOUT THIS SERIES

**Dimensions** : first dimensions are in mm while inches are shown as bracketed numbers.

**Security caps** are available to prevent inadvertent lever operation. They are presented in section I.



**Sealing boots** are available to protect the switches against dust and water. They are presented in section H.



**Mounting accessories** : standard hardware supplied with all models : 2 matt black nuts U41, matt black locking ring U12, zinc plated lockwasher U13  
They are presented in section I.



**Packaging unit** : 25 pieces, except model 6421 (20 pieces)



# 6000 series

Toggle switches for military applications

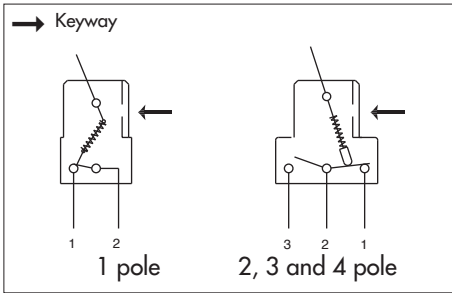

- Screw terminals standard
- Solder lug or quick-connect terminals optional
- 1, 2, 3 and 4-pole configurations

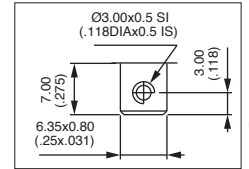

MODEL STRUCTURE

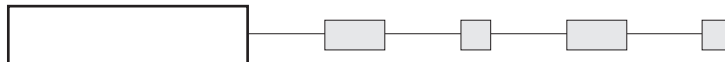

## Single pole

→ Keyway



6421A-03

|  | I  | II  |
|--|----|-----|
|  | ON | OFF |

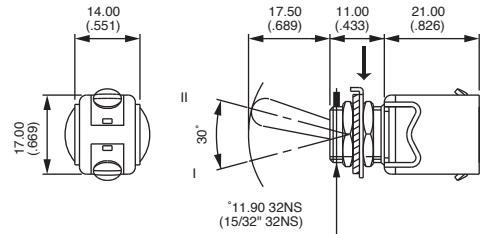

## Double pole

→ Keyway



6641-03  
6642-03  
6643-03  
6644-03 ▲  
6645-03  
6646-03  
6647-03  
6648-03  
6649-03

|  | III | II  | I       |
|--|-----|-----|---------|
|  | 2-1 |     | 2-3     |
|  | 5-4 |     | 5-6     |
|  | ON  | -   | OFF     |
|  | ON  | -   | mom.OFF |
|  | MOM | -   | OFF     |
|  | ON  | ON  | ON      |
|  | MOM | -   | ON      |
|  | ON  | -   | ON      |
|  | MOM | OFF | MOM     |
|  | ON  | OFF | MOM     |
|  | ON  | OFF | ON      |

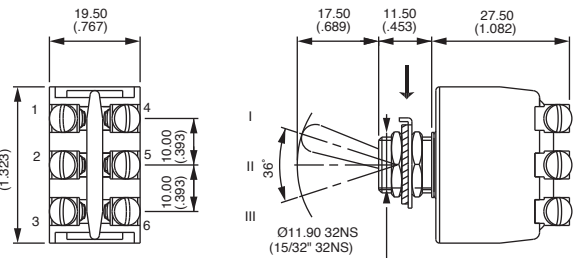

▲ Function 4 : SP in DP case, see end of catalogue.

## Three pole

→ Keyway



6651-03  
6652-03  
6653-03  
6655-03  
6656-03  
6657-03  
6658-03  
6659-03

|  | III* | II  | I**     |
|--|------|-----|---------|
|  | ON   | -   | OFF     |
|  | ON   | -   | mom.OFF |
|  | MOM  | -   | OFF     |
|  | MOM  | -   | ON      |
|  | ON   | -   | ON      |
|  | MOM  | OFF | MOM     |
|  | ON   | OFF | MOM     |
|  | ON   | OFF | ON      |

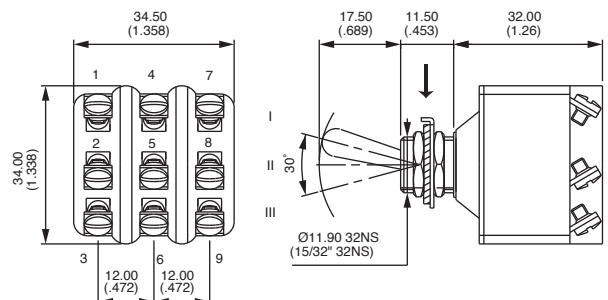

\* (2-1) (5-4) (8-7)    \*\* (2-3) (5-6) (8-9)

# 6000 series

Toggle switches for military applications

OPTIONS



## Four pole

→ Keyway



|           | III* | II  | I**     |
|-----------|------|-----|---------|
| 6661-03   | ON   | -   | OFF     |
| 6662-03   | ON   | -   | mom.OFF |
| 6663-03   | MOM  | -   | OFF     |
| 6664-03 ▲ | ON   | ON  | ON      |
| 6665-03   | MOM  | -   | ON      |
| 6666-03   | ON   | -   | ON      |
| 6667-03   | MOM  | OFF | MOM     |
| 6668-03   | ON   | OFF | MOM     |
| 6669-03   | ON   | OFF | ON      |

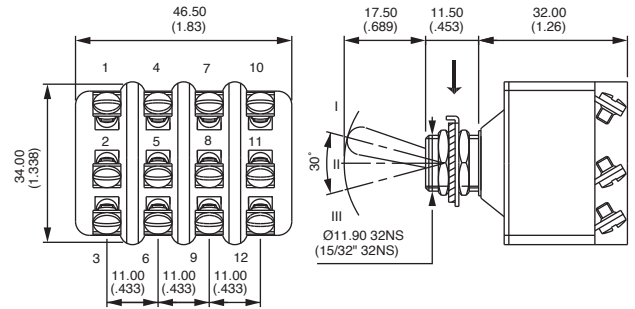

\* (2-1) (5-4) (8-7) (11-10)

\*\* (2-3) (5-6) (8-9) (11-12)

▲ Function 4 : 2P in 4P case, see end of catalogue.

### STANDARD PANEL CUT-OUT

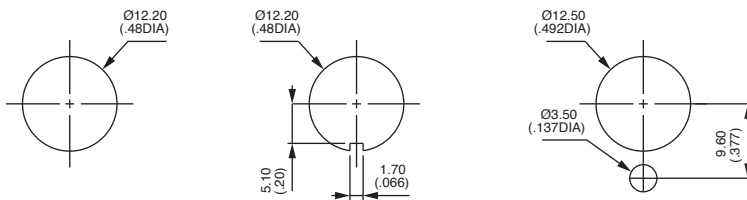

### PANEL CUT-OUT WITH "K" SEALING

Recommended cut-out and mounting depending on panel thickness

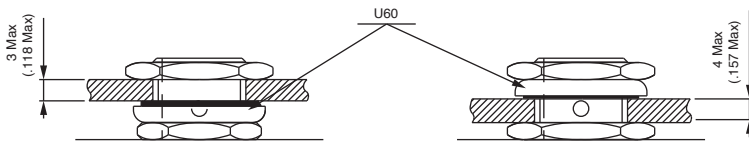

### FINISH

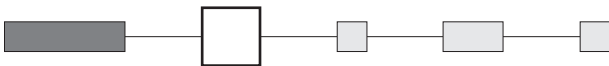

- B** Lever and bushing with grey satin chrome finish
- LM** Nickel plated bushing - lever and upper nut bright chrome plated
- 8** Black lever with fluorescent tip



# 6000 series

Toggle switches for military applications

## SEALING



**K** Frontal sealing by O-ring and sealing washer. Protects the switch against water and dust. Panel seal withstands 1 bar pressure and remains sealed even when switch is operated

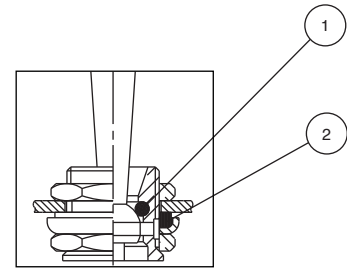

① O-ring ② Sealing washer

## LOCKING LEVERS

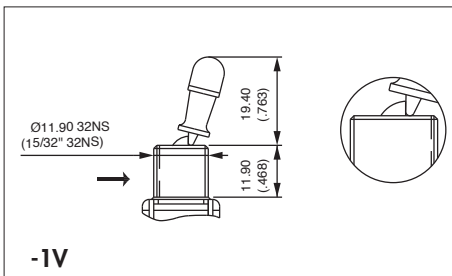

**-1V**

1 locked position

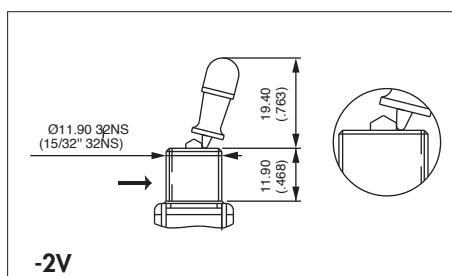

**-2V**

2 locked positions

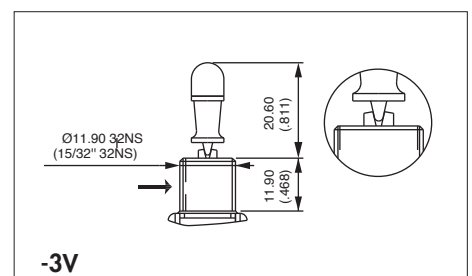

**-3V**

3 locked positions

→ Keyway

## TERMINALS



- Blank** Screw terminals
- /2** Solder lug terminals
- /3** Quick-connect terminals 6,35 x 0,8 (.250 x .031)



Not available on single pole models.

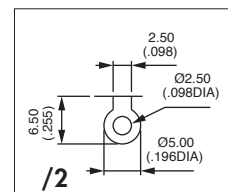

**/2**

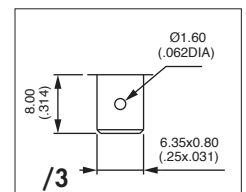

**/3**

## NEOPRENE PROTECTION CAPS

These caps are designed to insulate terminals against electrical short circuit.



For 1-pole models

**U58**

For 2-pole models

**U120**

For 3-pole models

**U46**

For 4-pole models

**U47**

To be ordered separately. Example : PROTECTION CAP U58