

RT7310 Evaluate Report for Triac Dim Bulb EVB (Buck-Boost)

*ACDC BU / SLM Division
July 2016*

<http://www.richtek.com/LED>

RICHTEK
your power partner.

RT7310 Brief Introduction

RT7310 is an active power factor correction controller specifically designed for using as a constant current LED driver.

Supporting:

Isolation: PSR Flyback

Non-isolation: PSR Buck-Boost

Applications ➡ **TRIAC Dimmable LED Driver**



RT7310 Features

Phase-Cut Dimmable Primary-Side Regulation LED Driver Controller with Active PFC

- Primary Side Regulation(PSR)
- Power Factor Correction(PFC)
- Critical conduction mode(CRM)
- Max/Min switch frequency clamping
- Max/Min on time limitation
- THD Optimization
- Supporting Phase-Cut Dimmers

RT7310 Advantage

- Tight LED Current Regulation
- Protection:
 - a. LED open-circuit protection
 - b. LED short-circuit protection
 - c. Output diode short-circuit protection
 - d. Vdd under/over voltage protection
 - e. Over temperature protection
 - f . Cycle-by-cycle current limitation

Circuit

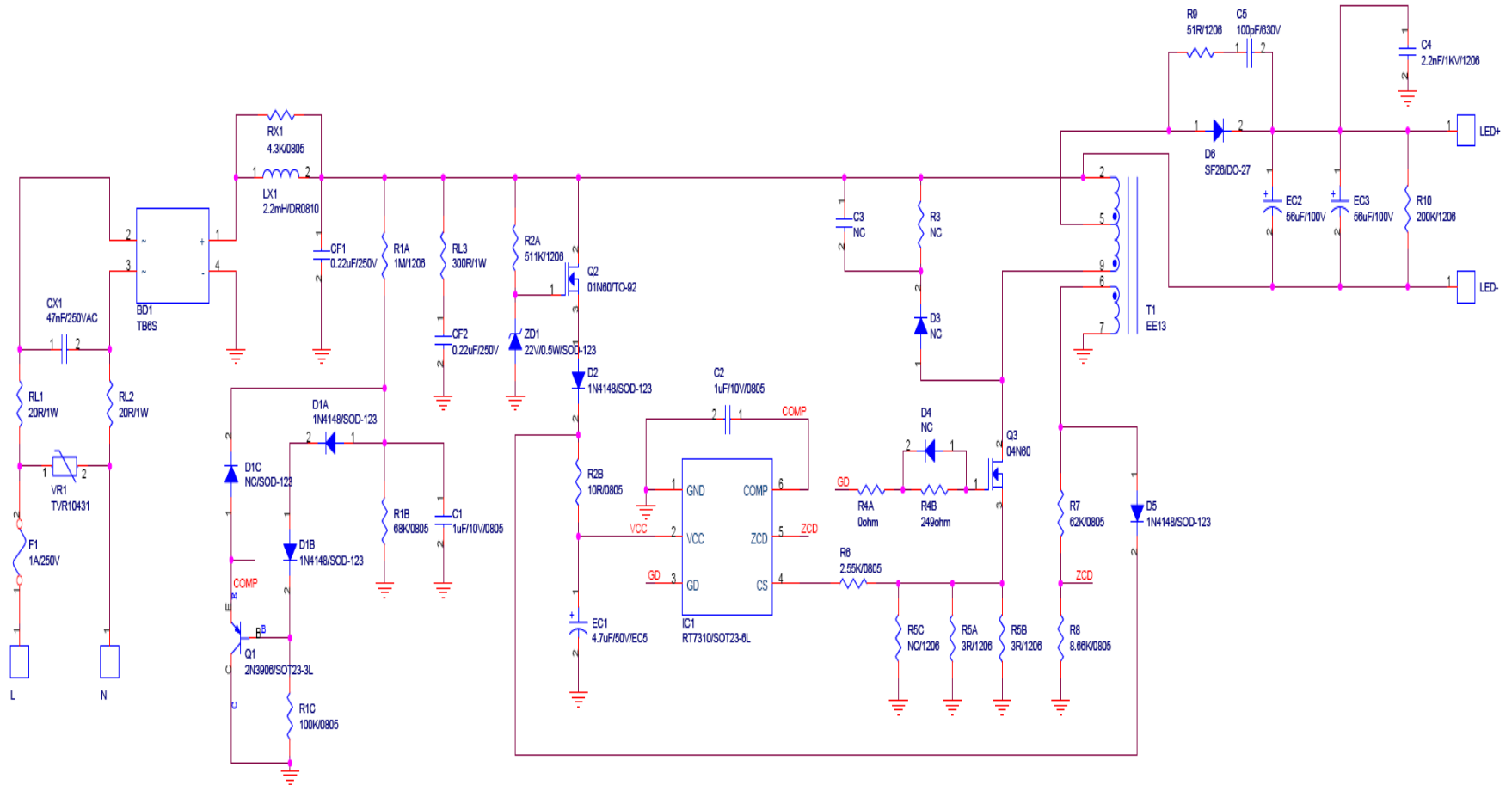

Electrical Performance

Load: LED Line filter off

Frequency	Vac [V]	Pin [watt]	Vout [V]	Iout [mA]	Pout [Watt]	Eff. [%]	PF Value	THD
60Hz	90	10.14	71.99	119	8.57	84.49%	0.9904	7.17
60Hz	100	10.04	72.03	119	8.57	85.37%	0.9851	8.45
60Hz	110	10.00	72.09	119	8.58	85.79%	0.9783	9.92
60Hz	120	10.00	72.14	120	8.66	86.57%	0.9698	11.47
60Hz	132	10.07	72.25	120	8.67	86.10%	0.9572	13.04

90Vac~132Vac current regulation = 0.83%

100Vac~120Vac current regulation = 0.83%

△ Efficiency = 2.08%

Maximum PFC = 0.990

Minimum PFC = 0.957

Efficiency

Efficiency

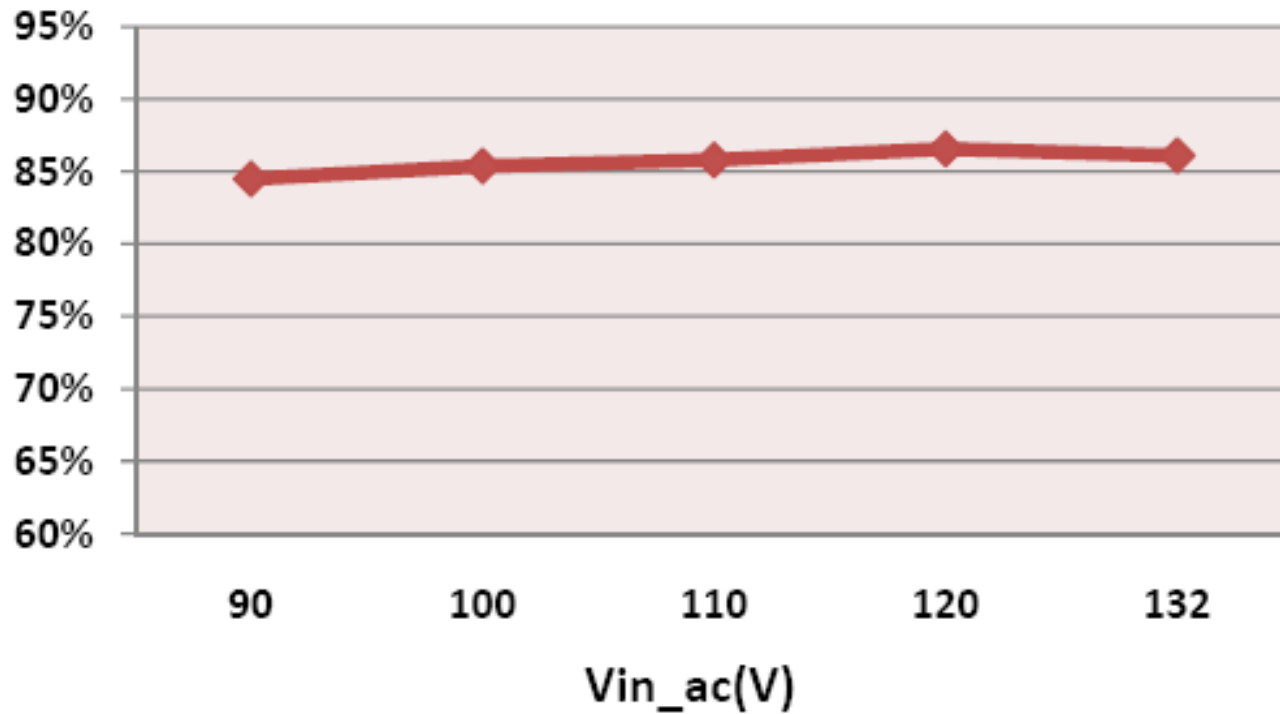

Power Factor

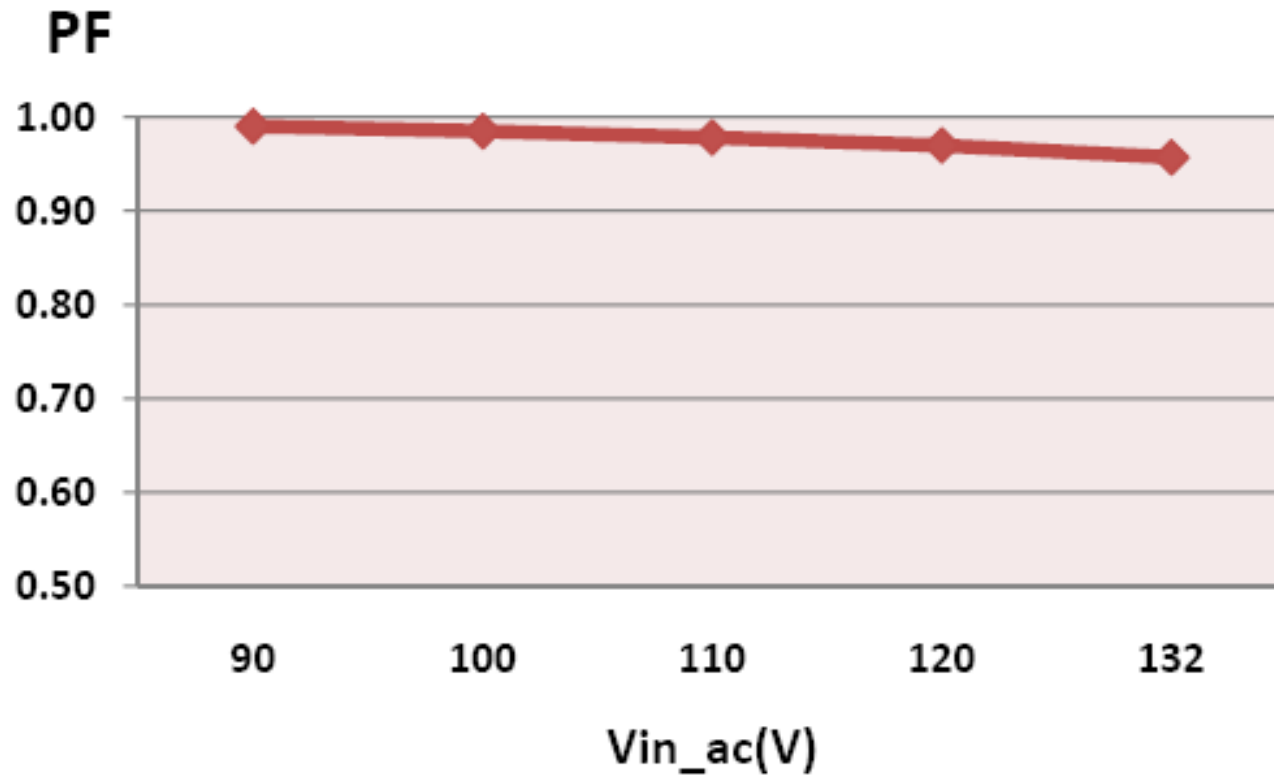

Current Regulation

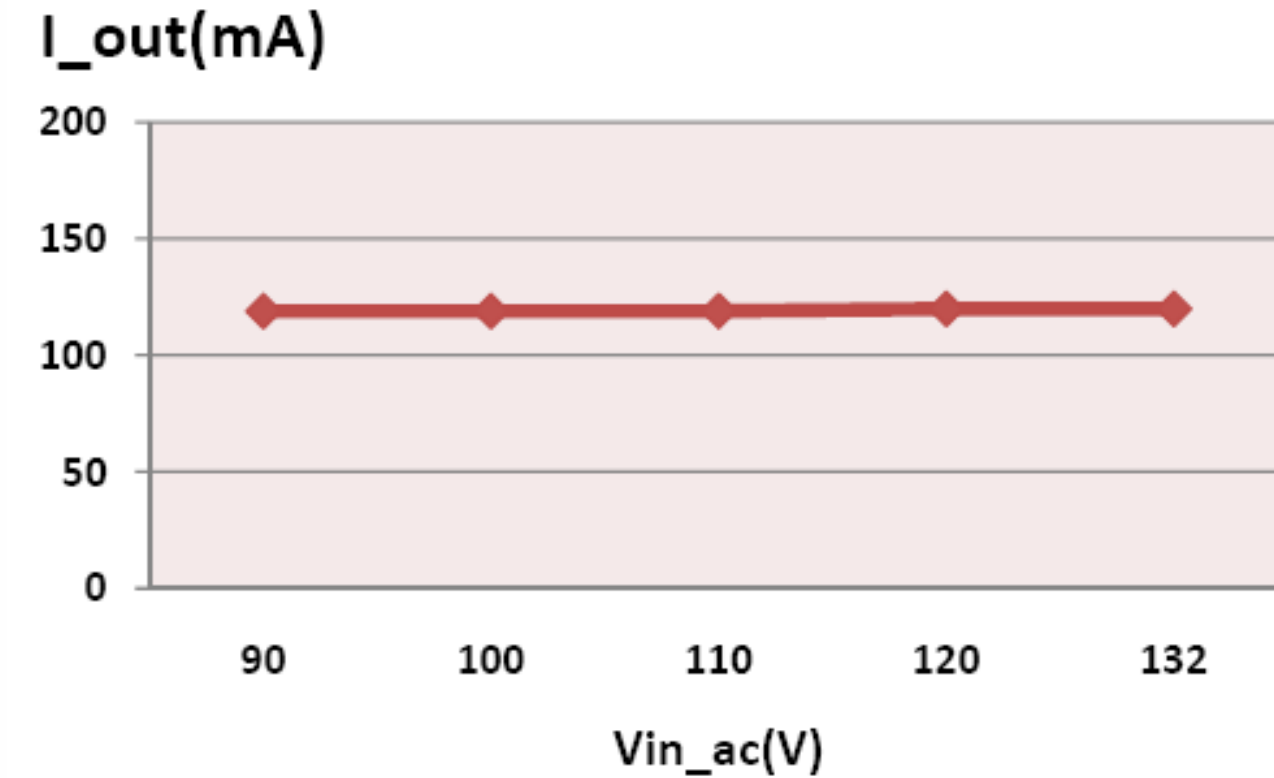

Load Regulation

Frequency	Vac [V]	Vout [V]	Iout [mA]
60Hz	120	69.02	119.0
60Hz	120	72.14	120.0
60Hz	120	75.24	120.0

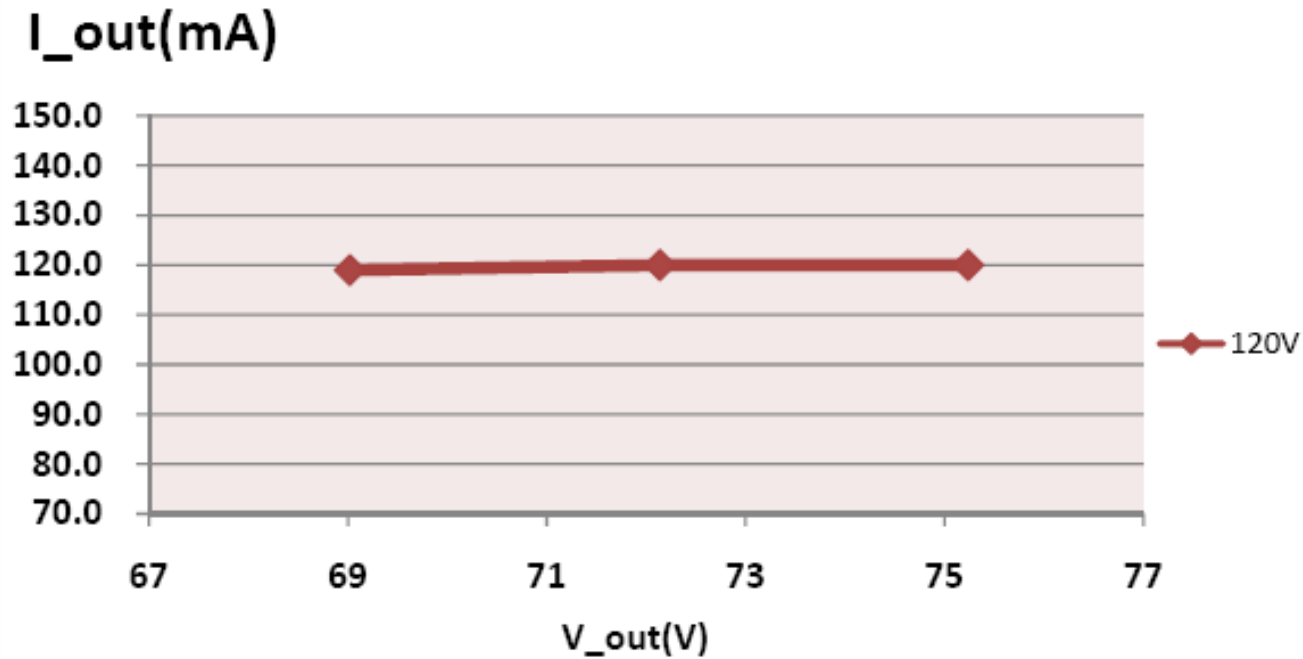

Temperature

(Test Condition: Burn-in 30min. @ Ta=25 °C)

90Vac/50Hz input , Full load output

RL1	20R	63.9
RL2	20R	64.5
BD1	ABS10	53.4
RL3	300R	34.2
LX1	2.2mH	51.5
T1-wire	EE-1305	57.1
T1-core	EE-1305	53.7
D6	SF26	46.2
Q3	4N60	62.3
R5A,R5B	3R//3R	51.4

132Vac/50Hz input , Full load output

RL1	20R	46.1
RL2	20R	46.0
BD1	ABS10	45.3
RL3	300R	34.4
LX1	2.2mH	43.4
T1-wire	EE-1305	55.1
T1-core	EE-1305	52.2
D6	SF26	44.8
Q3	4N60	53.5
R5A,R5B	3R//3R	48.7

Mains(110Vac) input (at Input peak current is max with S-600P triac dimming)

RL1	20R	56.3
RL2	20R	55.4
BD1	ABS10	39.3
RL3	300R	53.1
LX1	2.2mH	38.1
T1-wire	EE-1305	39.3
T1-core	EE-1305	37.5
D6	SF26	35.5
Q3	4N60	42.1
R5A,R5B	3R//3R	38.2

Triac Dimmer Compatibility (1)

Brand	Model	Load MAX. (Unit:W)	Poles	Led current Range (Unit:mA)	Flickering situation	Brightness duty_min (Unit: %)
Lutron	TG-600PNLH	600W 120V / 60Hz	Both	120-0	NO	0.00%
Lutron Skylark	S-600P	600W 120V / 60Hz	Both	121-0	NO	0.00%
Lutron Skylark	SELVB-300P	300W 120V / 60Hz	3 Way (Trailing edge)	120-7	NO	5.83%
Lutron	DVELV-300P	300W 120V / 60Hz	3 Way (Trailing edge)	120-6	NO	5.00%
Lutron Skylark	CTELV-303P	300W 120V / 60Hz	3 Way (Trailing edge)	120-7	NO	5.83%
Lutron DIVA	DV-600P	600W 120V / 60Hz	Both	120-0	NO	0.00%
Leviton	PRI06	600W 120V / 60Hz	Single way	121-0	NO	0.00%
Leviton	6673	600W 120V / 60Hz	Both	121-0	NO	0.00%
Leviton	IPI06	600W 120V / 60Hz	Both	120-3	NO	2.50%
Lutron	S-600H-WH	600W 120V / 60Hz	Single way	120-0	NO	0.00%
Leviton	6681	600W 120V / 60Hz	Both	120-0	NO	0.00%
Lutron	D-600PH-DK	600W 120V / 60Hz	Both	121-0	NO	0.00%
TOSHIBA	DG9022H	200W 100V/60Hz	Both	120-3	NO	0.03%

Triac Dimmer Compatibility (2)

Brand	Model	Load MAX. (Unit:W)	Poles	Led current Range (Unit:mA)	Flickering situation	Brightness duty_min (Unit: %)
KUEI LIN	unknow	500W 110V/60Hz	Both	120-0	NO	0.00%
DIING CHUNG	DC-308	800W 110V/60Hz	Both	120-4	NO	3.33%

Transformer

CORE SIZE: EE-1305 **Material:** PC40
Bobbin/PINs: Vertical/ 10 pins
Primary inductor: (+-10%) 1800uH

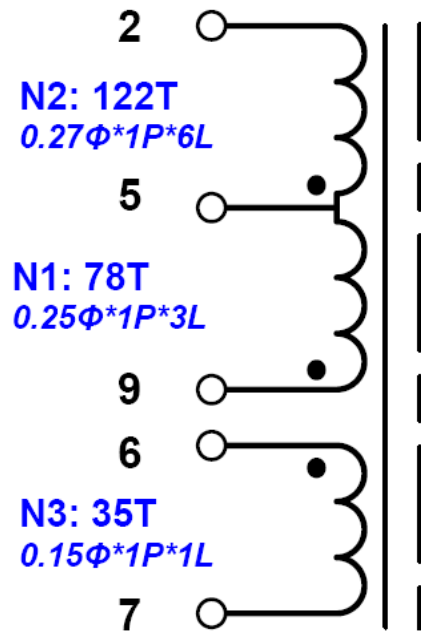
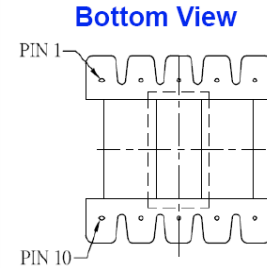

WINDING TABLE: (繞線結構)

Winding No. (組別)	PIN (腳位)	Wire & Wire & Copper (線徑 x 股數 x 層數)	Turns (圈數)	Winding Type (繞線方式)	Tape Layer (膠帶層次)
<i>Bobbin</i>					
N1	9 → 5	0.25x 1P x 3L	78Ts	密繞	1L
N2	5 → 2	0.27 x 1P x 6L	122Ts	密繞	1L
N3	6 → 7	0.15 x 1P x 1L	35Ts	密繞	2L
<i>Core – EE1305</i>				1800uH	

PCB Layout

TOP Layer

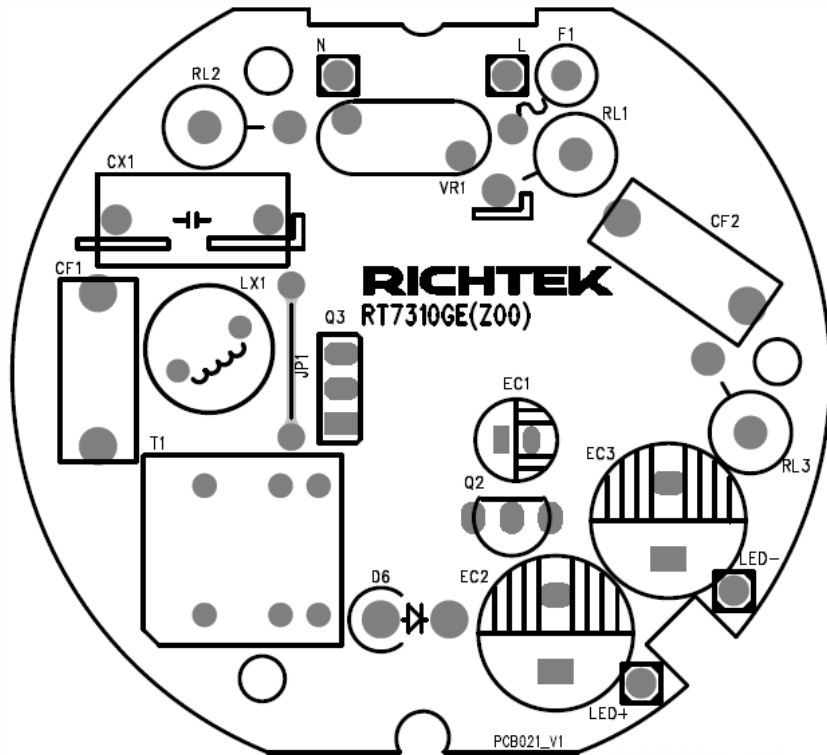

BOT Layer

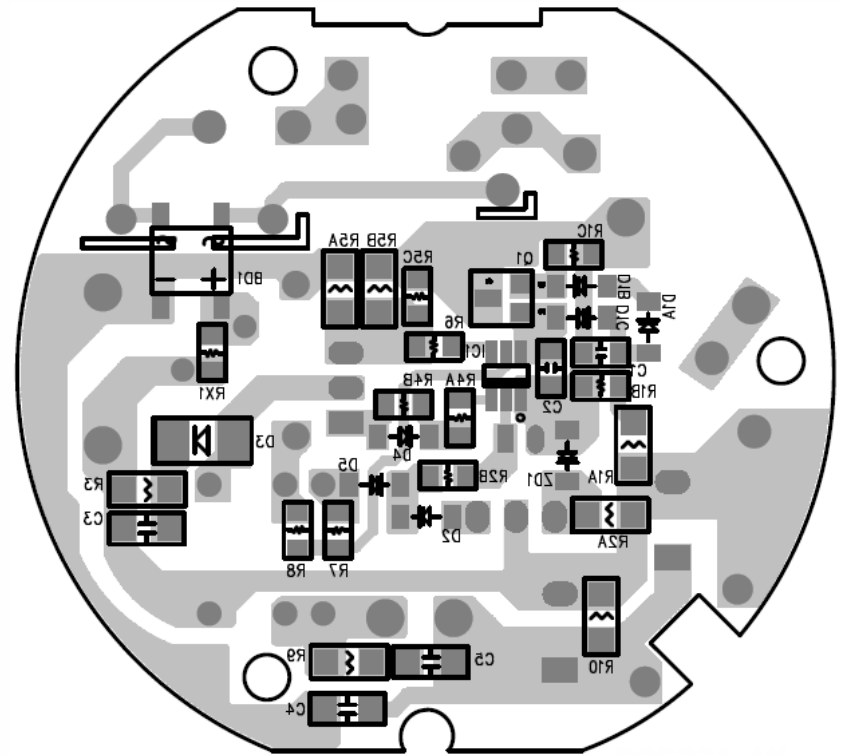

Demo Board Photo

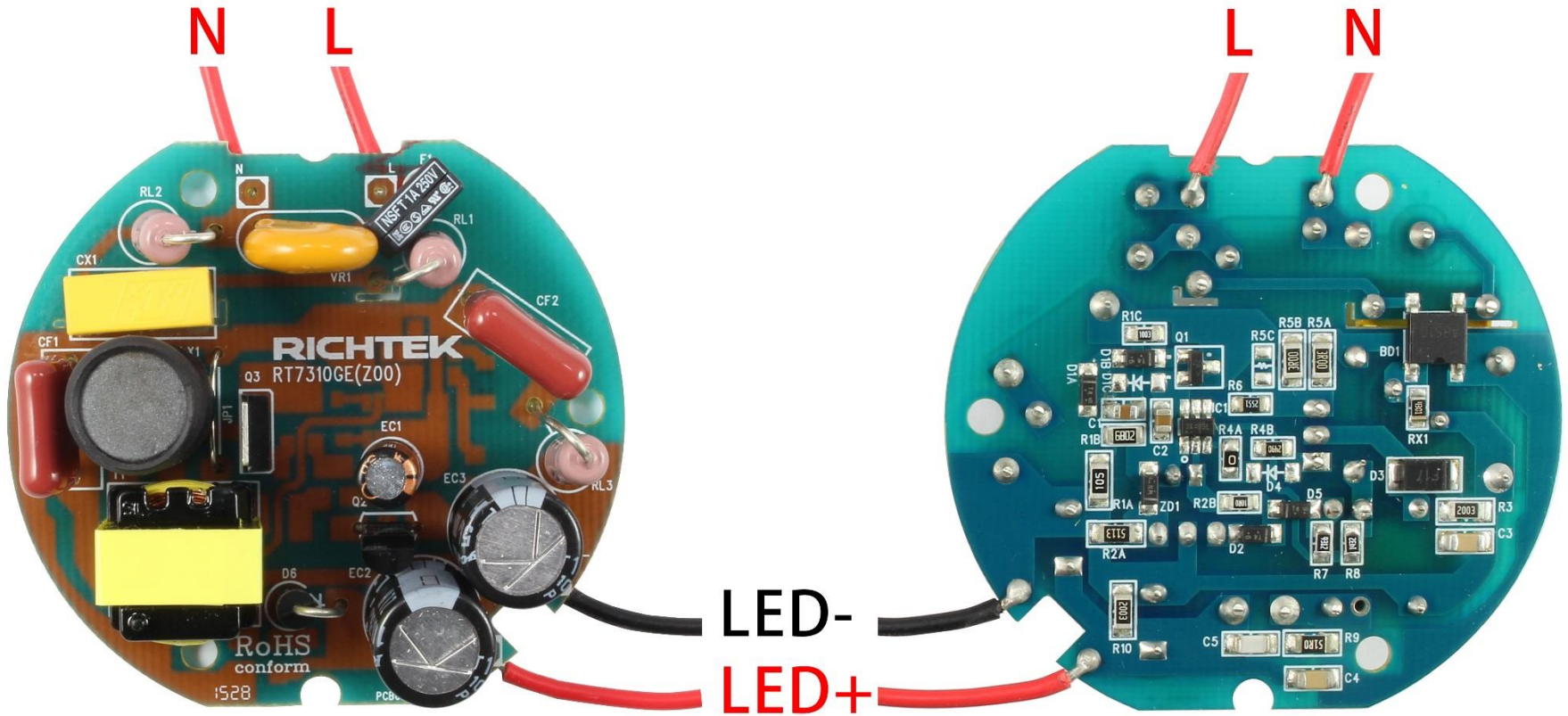

PCB No : PCB021_V1

BOM

Item	Location	Value	Type
1	F1	1A/250V	Fuse-5MM
2	VR1	TVR10431	VR-10-7.5MM
3	RL1, RL2	20ohm	R2W-5MM
4	CX1	47nF	CAP-12.5x6-10MM
5	BD1	TB6S	TBS
6	RX1	4.3kohm	R2W-5MM
7	RL3	300ohm	R2W-5MM
8	LX1	2.2mH	L-8-5.0MM
9	CF1, CL2	0.22uF	CAP-5x10MM
10	R1A	1Mohm	1206
11	R1B	68kohm	1206
12	R1C	100kohm	0805

BOM

Item	Location	Value	Type
13	D1A, D1B, D2, D5	1N4148	D-SOD123
14	Q1	2N3906	SOT23
15	C1	1uF	0805
16	R2A	511kohm	1206
17	ZD1	22V	D-SOD123
18	Q2	01N60	TO-92
19	R2B	10ohm	0805
20	EC1	4.7uF	EC-5MM
21	IC1	RT7310	SOT-236
22	C2	1uF	0805
23	R4B	249ohm	0805
24	R6	2.55kohm	0805

BOM

Item	Location	Value	Type
25	R5A, R5B	3ohm	1206
26	Q3	04N60	TO-251
27	T1	EE-13	EE-13
28	R7	62kohm	0805
29	R8	8.66kohm	0805
30	R9	51ohm	1206
31	C5	100pF	1206
32	D6	SF26	Diode4-P4.5
33	EC2, EC3	56uF/100V	EC-10
34	C4	2.2nF	1206
35	R10	200kohm	1206

Total: 36pcs

Power Component Voltage Stress

Test condition: 132Vac/60Hz input / 72V, 120mA output

Steady state			
Location	Max rating (V)	Measure	De-rating
Q1	600	433.8	72.3%
D1	400	221.2	55.3%

Transient			
Location	Max rating (V)	Measure	De-rating
Q1	600	434	72.33%
D1	400	223	55.75%

LED Open Protection

$V_{ac_in} = 110V$

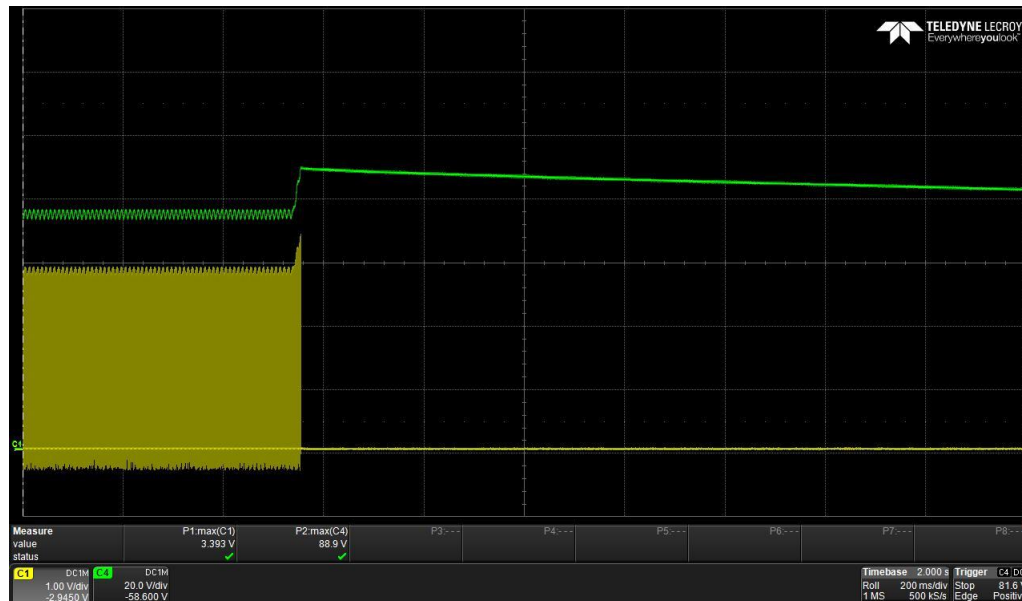

CH1:V-ZCD, CH4:V_LED

When LED open, the output keeps rising and causing the V_{ZCD} rising accordingly. If V_{zcd} trigger the protected level (2.9V~3.3V), the IC latch down. The OVP level is 88.9V.

LED Short Protection

$V_{ac_in} = 110V$

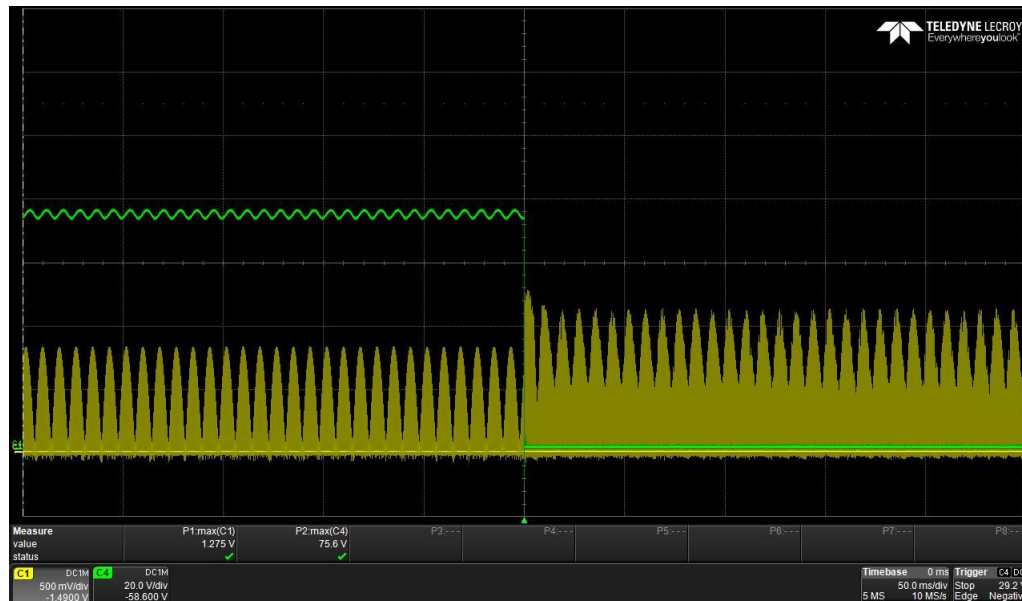

CH1:I_LED, CH4:V_LED

When LED short , the output level is 0V and the Vcs will rise to trigger the protected function. IC will be auto-restarted when the output is recovered.

Harmonic(IEC61000-3-2)

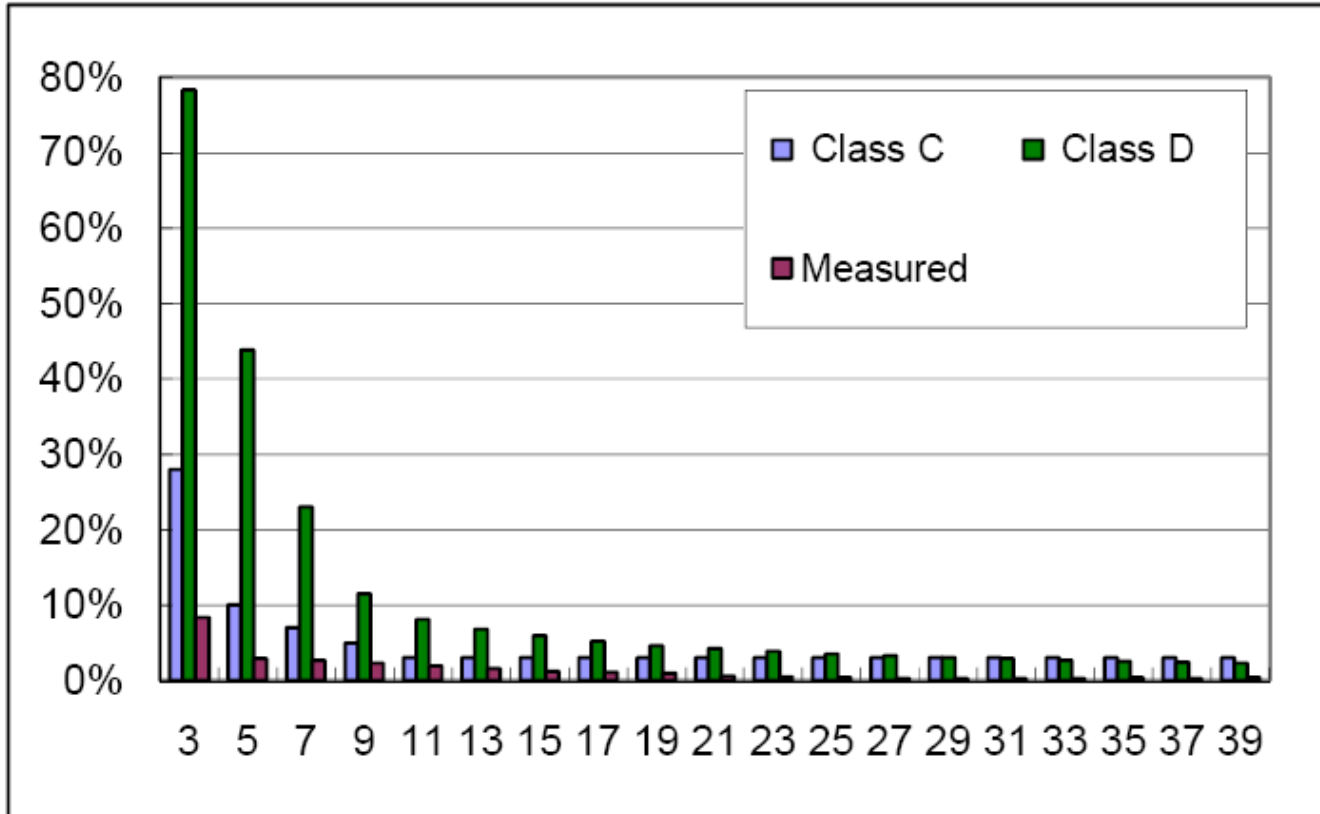

110Vac input
Class C : Pass
Class D : Pass

EMI (Conduction)

110Vac/60Hz-L1 → Pass

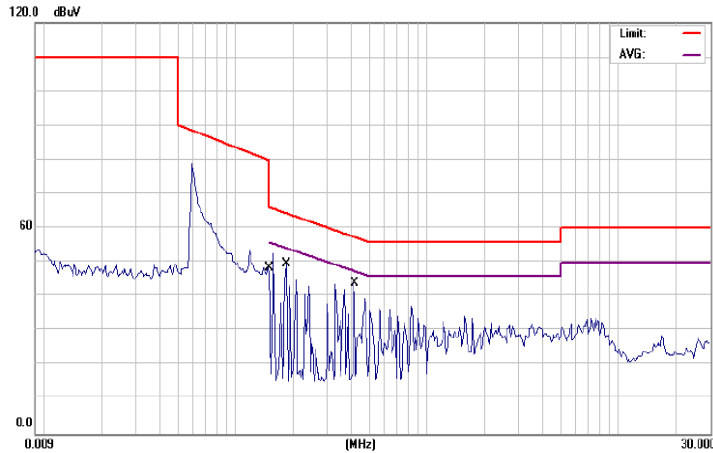

Site B5
 Limit: (CE)EN55015_QP
 EUT: LED
 M/N: RT7310 DL
 Note:

Phase: **L1**
 Power: AC 110V/60Hz

Temperature: 26 °C
 Humidity: 59 %
 Air Pressure: 983 hpa

110Vac/60Hz-L2 → Pass

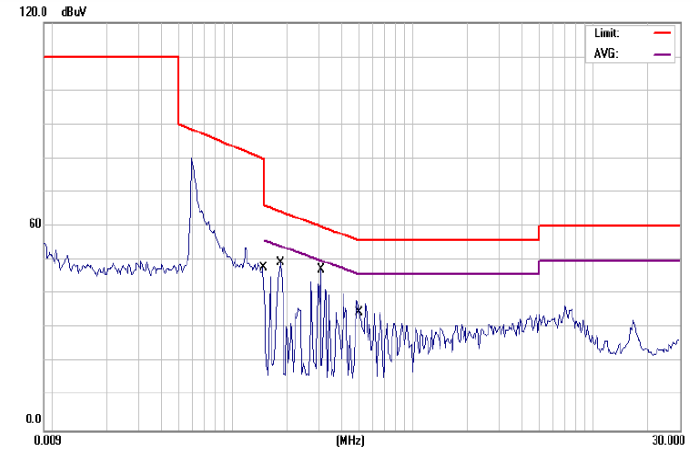

Site B5
 Limit: (CE)EN55015_QP
 EUT: LED
 M/N: RT7310 DL
 Note:

Phase: **N**
 Power: AC 110V/60Hz

Temperature: 26 °C
 Humidity: 59 %
 Air Pressure: 983 hpa

No. Mk.	Freq.	Reading Level	Factor	Measurement	Limit	Over	Detector	Comment
	MHz	dBuV	dB	dBuV	dBuV	dB		
1	0.1500	40.77	9.65	50.42	66.00	-15.58	QP	
2	0.1500	22.48	9.65	32.13	56.00	-23.87	AVG	
3 *	0.1839	40.42	9.65	50.07	64.31	-14.24	QP	
4	0.1839	29.78	9.65	39.43	54.31	-14.88	AVG	
5	0.4179	33.30	9.64	42.94	57.49	-14.55	QP	
6	0.4179	19.85	9.64	29.49	47.49	-18.00	AVG	

No. Mk.	Freq.	Reading Level	Factor	Measurement	Limit	Over	Detector	Comment
	MHz	dBuV	dB	dBuV	dBuV	dB		
1	0.1500	40.41	9.64	50.05	66.00	-15.95	QP	
2	0.1500	22.58	9.64	32.22	56.00	-23.78	AVG	
3 *	0.1850	40.02	9.64	49.66	64.26	-14.60	QP	
4	0.1850	28.80	9.64	38.44	54.26	-15.82	AVG	
5	0.3093	35.49	9.64	45.13	59.99	-14.86	QP	
6	0.3093	20.91	9.64	30.55	49.99	-19.44	AVG	
7	0.5149	23.75	9.63	33.38	56.00	-22.62	QP	
8	0.5149	6.66	9.63	16.29	46.00	-29.71	AVG	

EMI (Radiation)

110Vac/60Hz-V → Pass

110Vac/60Hz-H → Pass



No. 8 Lane 724, Bo Ai Street, Zhubei City,
Hsin Chu Hsien 302, Taiwan, R.O.C.
TEL: 03-656-9065
FAX: 03-656-9085



No. 8 Lane 724, Bo Ai Street, Zhubei City,
Hsin Chu Hsien 302, Taiwan, R.O.C.
TEL: 03-656-9065
FAX: 03-656-9085

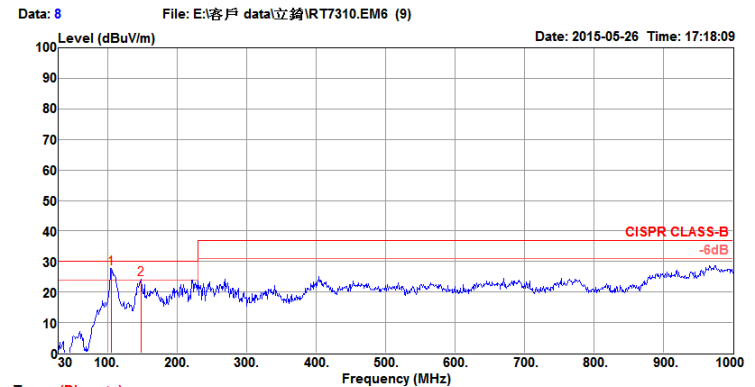
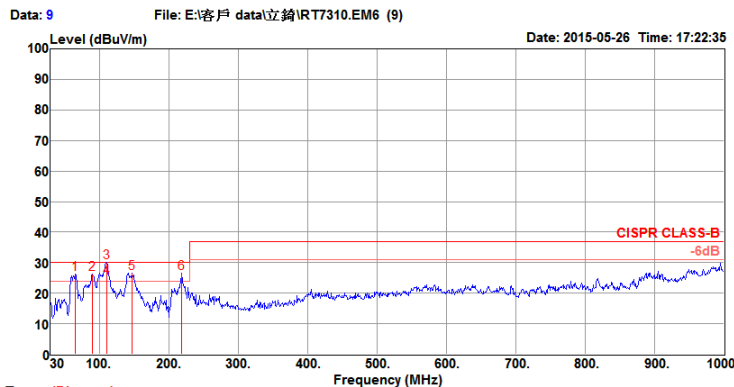

Trace: (Discrete)
Condition: CISPR CLASS-B 10m BILOG ANT 20141111 VERTICAL
: RBW:100.000KHz VBW:300.000KHz SWT:0.500sec
Engineer : Lucke
Eut : RT7310
Mode : Normal
Power : AC 110V/60Hz
Memo 5-1 : 72V/120mA
Memo 5-2 :

Trace: (Discrete)
Condition: CISPR CLASS-B 10m BILOG ANT 20141111 HORIZONTAL
: RBW:100.000KHz VBW:300.000KHz SWT:0.500sec
Engineer : Lucke
Eut : RT7310
Mode : Normal
Power : AC 110V/60Hz
Memo 5-1 : 72V/120mA
Memo 5-2 :

	Freq	Level	Limit	Over	Read	CableAntenna	Preamp	A/Pos	T/Pos	Remark	Pol/Phase
	MHz	dBuV/m	dBuV/m	dB	dBuV	Loss	Factor	Factor	cm	deg	
1	65.89	26.24	30.00	-3.76	52.53	0.80	6.84	32.32	100	198 Peak	VERTICAL
2	90.14	26.33	30.00	-3.67	51.63	0.92	9.20	32.23	100	256 Peak	VERTICAL
3	110.51	30.14	30.00	0.14	52.32	0.98	12.35	32.26	100	132 Peak	VERTICAL
4	110.75	24.94	30.00	-5.06	47.12	0.98	12.35	32.26	100	132 QP	VERTICAL
5	147.37	26.59	30.00	-3.41	50.70	1.10	11.45	32.16	100	180 Peak	VERTICAL
6	218.18	26.44	30.00	-3.56	46.32	1.30	10.72	32.07	100	91 Peak	VERTICAL

	Freq	Level	Limit	Over	Read	CableAntenna	Preamp	A/Pos	T/Pos	Remark	Pol/Phase
	MHz	dBuV/m	dBuV/m	dB	dBuV	Loss	Factor	Factor	cm	deg	
1	105.66	27.82	30.00	-2.18	53.51	0.96	11.82	32.26	100	183 Peak	HORIZONTAL
2	148.34	24.11	30.00	-5.89	51.80	1.10	11.36	32.15	100	183 Peak	HORIZONTAL

RICHTEK
your power partner.

thank you.