

Apr.1.2017 Copyright 2017 HIROSE ELECTRIC CO., LTD. All Rights Reserved.

RECOMMENDED PC BOARD HOLE PATTERN

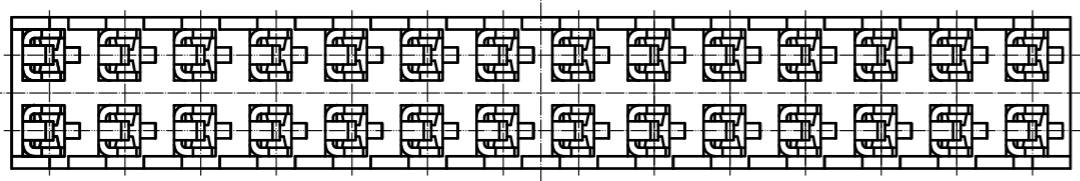
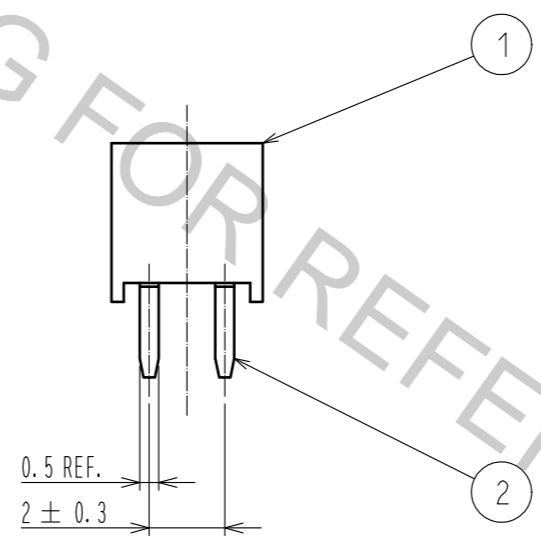
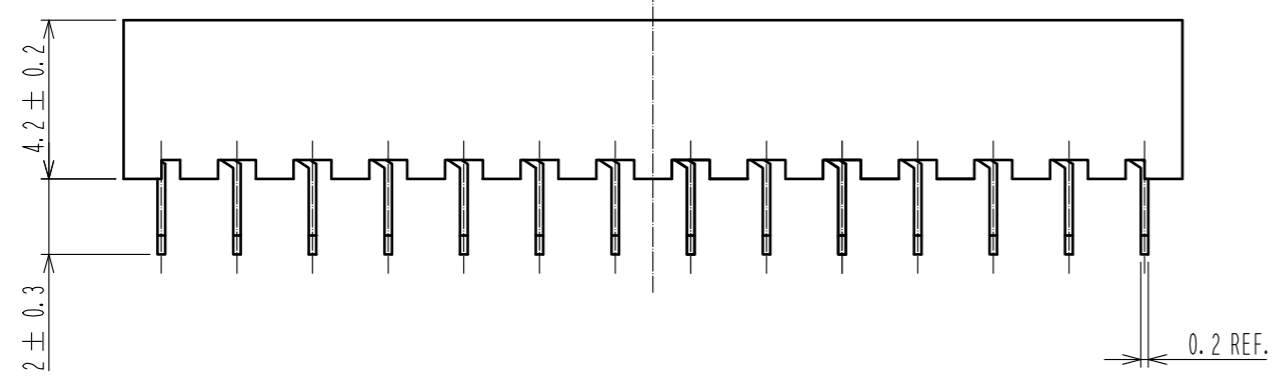
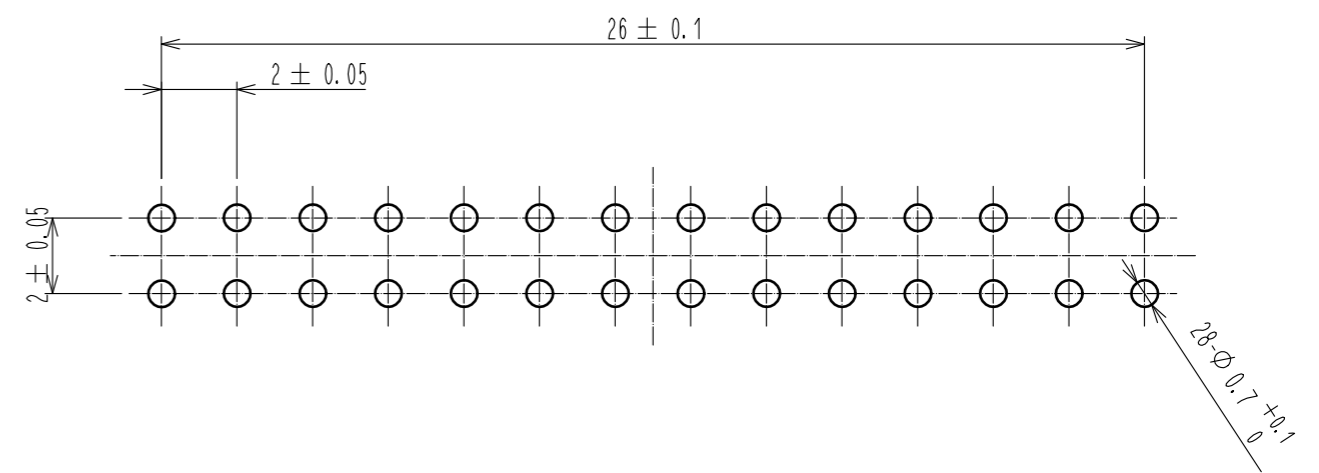
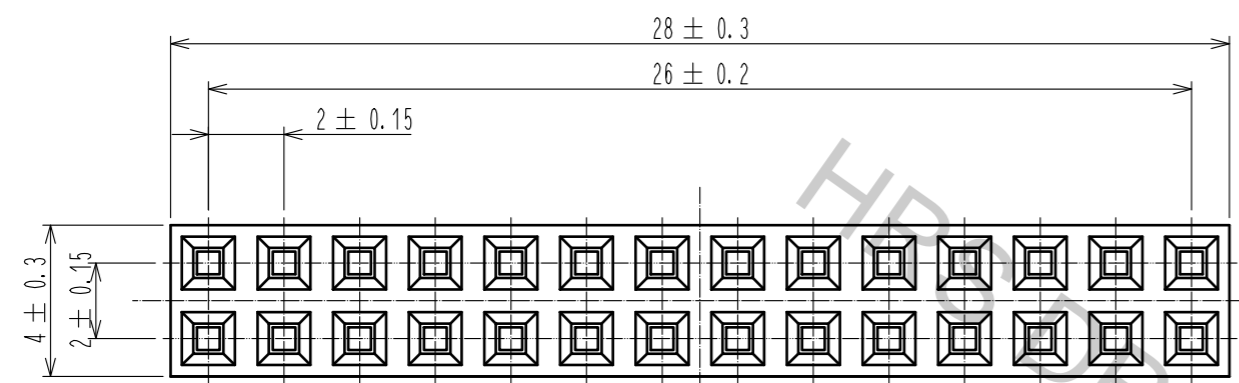

NOTES 1. THE CONTACT CUT SECTION IS UNPLATED.

1	PBT	BLACK. UL94V-0	2	PHOSPHOR BRONZE	CONTACT: GOLD PLATING 0.2μm MIN DIP : TIN PLATING 1μm MIN UNDER :NICKEL PLATING 1μm MIN		
NO.	MATERIAL	FINISH . REMARKS	NO.	MATERIAL	FINISH . REMARKS		
UNITS mm		SCALE 5:1	COUNT 	DESCRIPTION OF REVISIONS	DESIGNED	CHECKED	DATE
HRS HIROSE ELECTRIC CO., LTD.		APPROVED : HS. OKAWA	15.06.04	DRAWING NO. EDC-081249-71-21			
		CHECKED : HT. YAMAGUCHI	15.06.04	PART NO. A3C-28DA-2DSC(71)			
		DESIGNED : MT. ITANO	15.06.04	CODE NO. CL621-0543-6-71			
		DRAWN : MT. ITANO	15.06.04				