

●Application

- Motor drive
- Inverter, Converter
- Photovoltaics, wind power generation.
- Induction heating equipment.

●Features

- 1) Low surge, low switching loss.
- 2) High-speed switching possible.
- 3) Reduced temperature dependence.

●Construction

This product is a half bridge module consisting of SiC-DMOS from ROHM.

●Circuit diagram

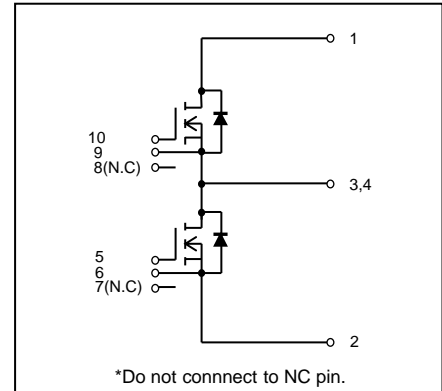

●Dimensions & Pin layout (Unit : mm)

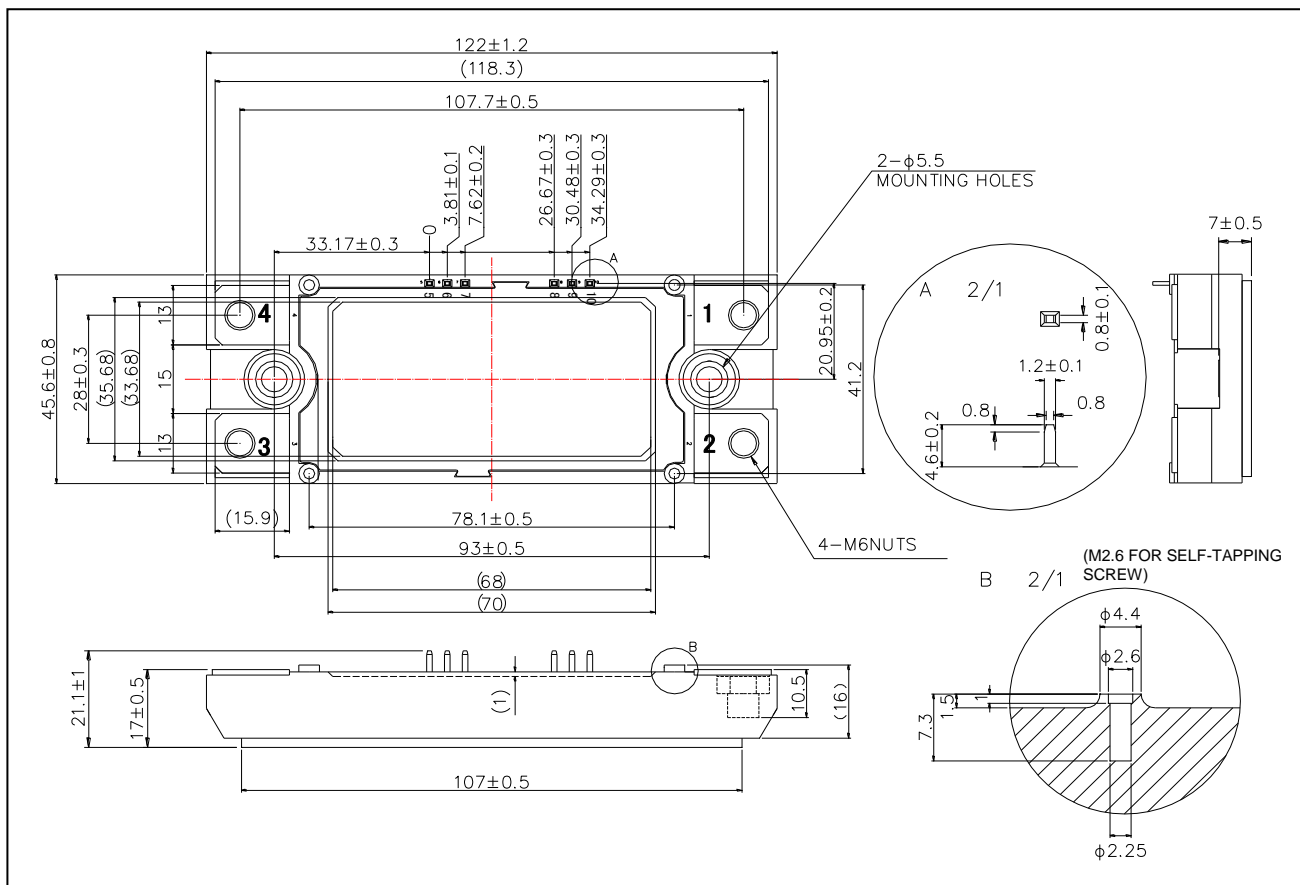

●Absolute maximum ratings (Tj = 25°C)

Parameter	Symbol	Conditions	Limit	Unit
Drain-source voltage	V _{DSS}	G-S short	1200	V
Gate-source voltage(+)	V _{GSS}	D-S short	22	V
Gate-source voltage(-)		D-S short	-6	V
G - S Voltage (tsurge<300nsec)	V _{GSSsurge}	D-S short	-10 to +26	°C
Drain current *1	I _D	DC(Tc=60°C)	204	A
	I _{DRM}	Pulse (Tc=60°C) 1ms *2	360	A
Source current *1	I _S	Tc=60°C V _{GS} =18V	204	A
		Pulse (Tc=60°C) 1ms V _{GS} =18V *2	360	A
	I _{SRM}	Pulse (Tc=60°C) 10μs V _{GS} =0V *2*3	1360	A
Total power dissipation *4	P _{tot}	Tc=25°C	175	W
Max Junction Temperature	Tjmax		-40 to150	°C
Storage temperature	Tstg		-40 to125	°C
Isolation voltage	Visol	Terminals to baseplate, f=60Hz AC 1min.	2500	Vrms
Mounting torque	-	Main Terminals : M6 screw	4.5	N · m
		Mounting to heat shink : M5 screw	3.5	N · m

(*1) Measurement of Tc is to be done at the point just under the chip.

(*2) Repetition rate should be kept within the range where temperature rise of die should not exceed Tj max.

(*3) Duration of current conduction at gate-off state should not exceed 10μsec.

(*4) Tj is less than 175°C

Example of acceptable VGS waveform

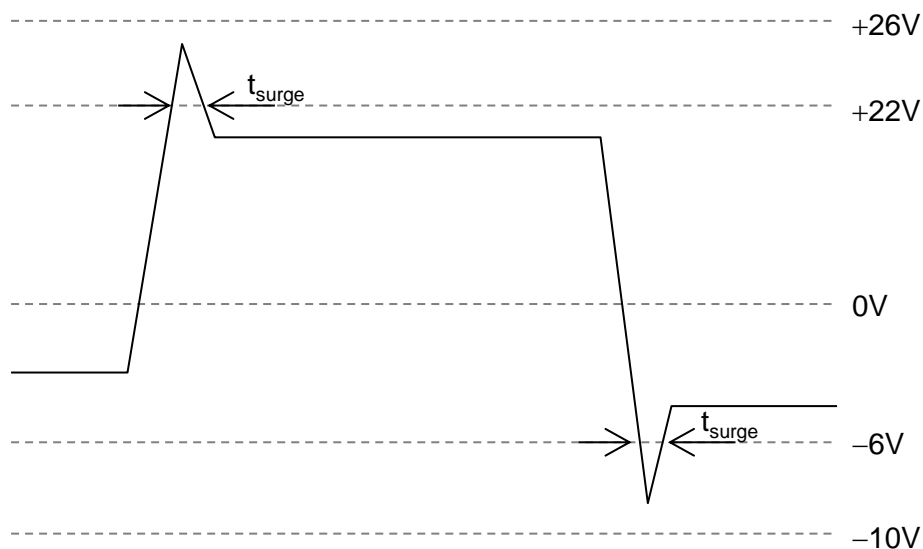

●Electrical characteristics (Tj=25°C)

Parameter	Symbol	Conditions	Min.	Typ.	Max.	Unit	
Static drain-source on-state voltage	$V_{DS(on)}$	$I_C=180A, V_{GS}=18V$	Tj=25°C	-	2.3	3.2	V
			Tj=125°C	-	3.3	4.4	
			Tj=150°C	-	3.6	5	
Drain cutoff current	I_{DSS}	$V_{DS}=1200V, V_{GS}=0V$	-	-	10	μA	
Source-drain voltage	V_{SD}	$V_{GS}=0V, I_S=180A$	Tj=25°C	-	5.4	-	V
			Tj=125°C	-	5.1	-	
			Tj=150°C	-	4.8	-	
		$V_{GS}=18V, I_S=180A$	Tj=25°C	-	2.3	-	
			Tj=125°C	-	3.3	-	
			Tj=150°C	-	3.5	-	
Gate-source threshold voltage	$V_{GS(th)}$	$V_{DS}=10V, I_D=35.2mA$	1.6	2.7	4	V	
Gate-source leakage current	I_{GSS}	$V_{GS}=22V, V_{DS}=0V$	-	-	0.5	μA	
		$V_{GS}=-6V, V_{DS}=0V$	-0.5	-	-		
Switching characteristics	td(on)	$V_{GS(on)}=18V, V_{GS(off)}=0V$	-	80	-	ns	
	tr	$V_{DS}=600V$	-	90	-		
	trr	$I_D=180A$	-	50	-		
	td(off)	$R_G=5.6\Omega$	-	300	-		
	tr	inductive load	-	90	-		
Input capacitance	C_{iss}	$V_{DS}=10V, V_{GS}=0V, f=1MHz$	-	23	-	nF	
Internal gate resistor	R_{Gint}	Tj=25°C	-	1.15	-	Ω	
Stray Inductance	L_s		-	25	-	nH	
Creepage Distance	-	Terminal to heat sink	-	11.5	-	mm	
		Terminal to terminal	-	19.0	-	mm	
Clearance Distance	-	Terminal to heat sink	-	9.5	-	mm	
		Terminal to terminal	-	13.0	-	mm	
Junction-to-case thermal resistance	$R_{th(j-c)}$	DMOS (1/2 module) *5	-	-	0.11	°C/W	
Case-to-heat sink Thermal resistance	$R_{th(c-f)}$	Case to heat sink, per 1 module, Thermal grease applied *6	-	0.035	-		

(*5) Measurement of Tc is to be done at the point just beneath the chip.

(*6) Typical value is measured by using thermally conductive grease of $\lambda=0.9W / (m \cdot K)$.

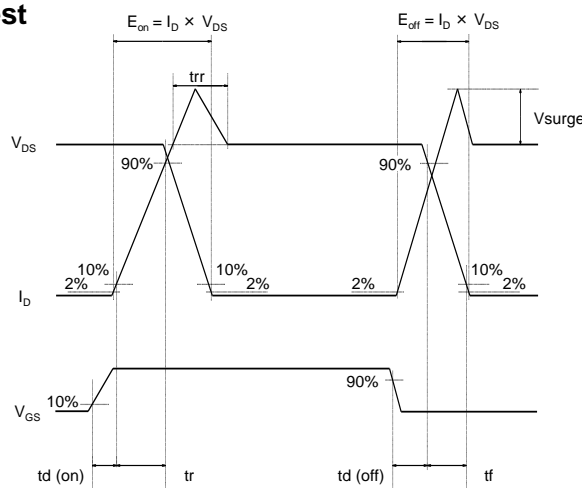
●Waveform for switching test

●Electrical characteristic curves (Typical)

Fig.1 Typical Output Characteristics

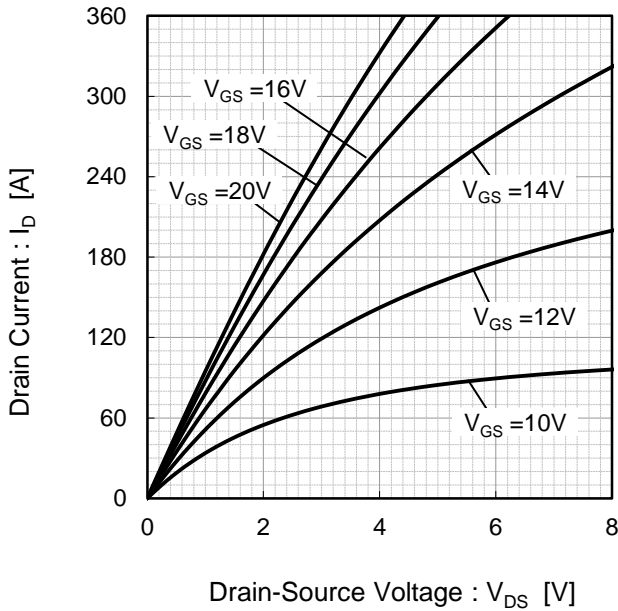

Fig.2 Drain-Source Voltage vs. Drain Current

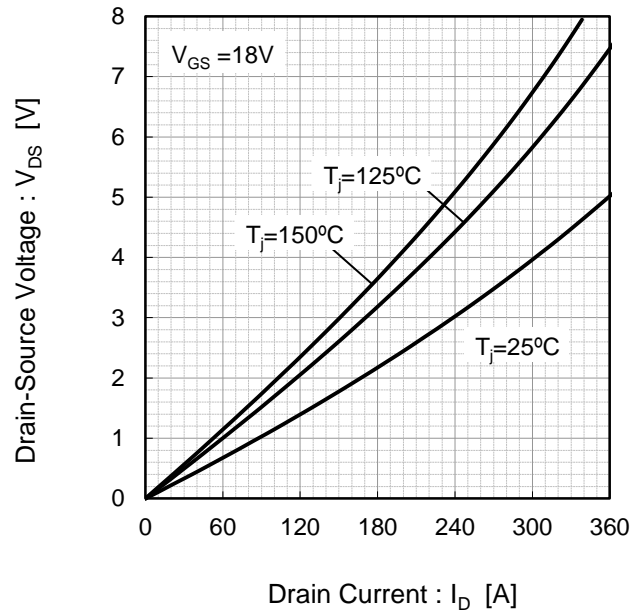

Fig.3 Drain-Source Voltage vs. Gate-Source Voltage

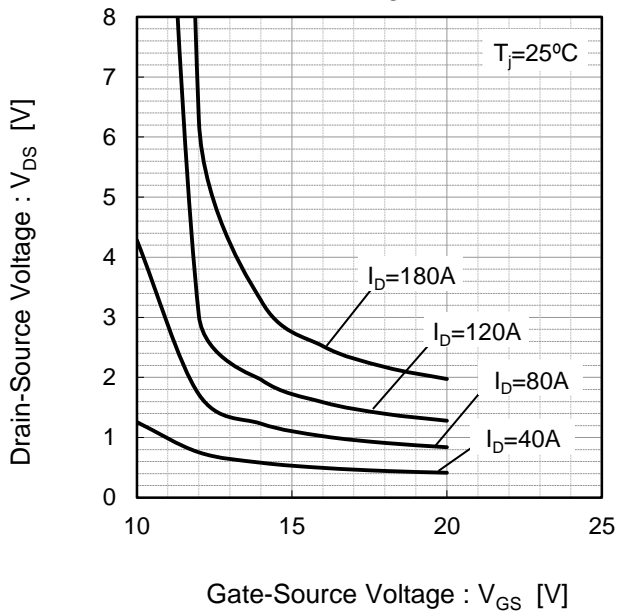
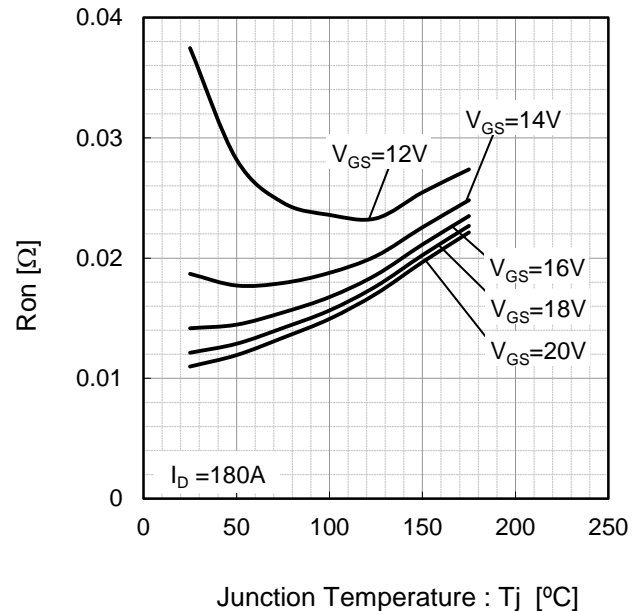

Fig.4 Ron vs Junction Temperature



●Electrical characteristic curves (Typical)

Fig.5 Drain Current vs. Gate-Source Voltage

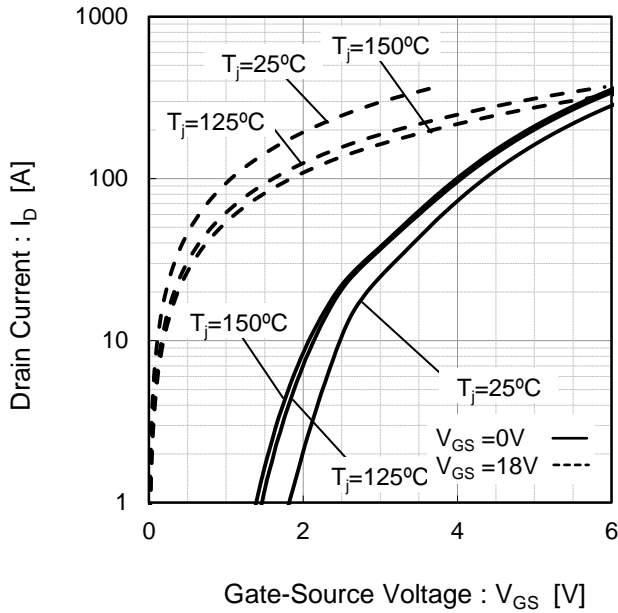

Fig.6 Drain Current vs. Gate-Source Voltage

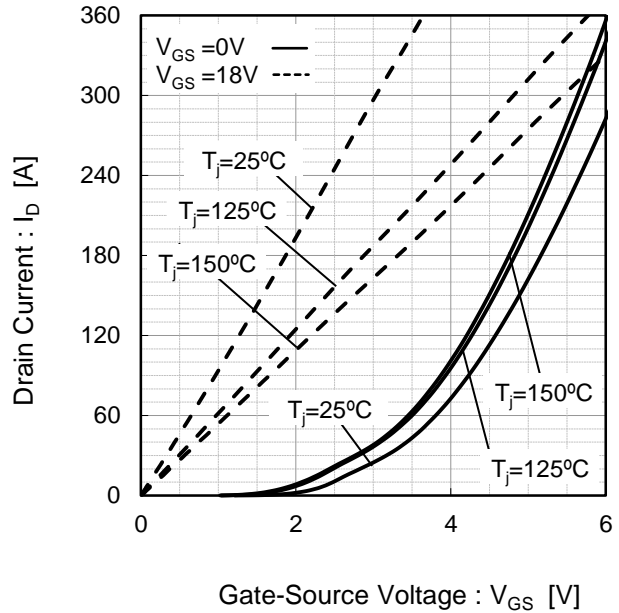

Fig.7 Drain Current vs. Gate-Source Voltage

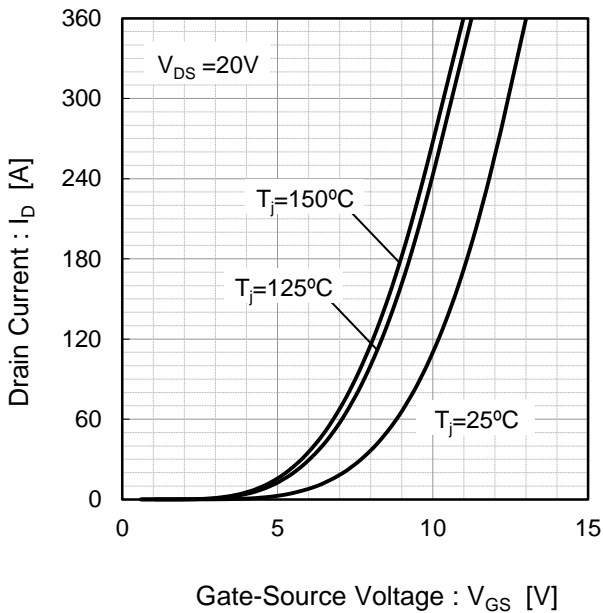
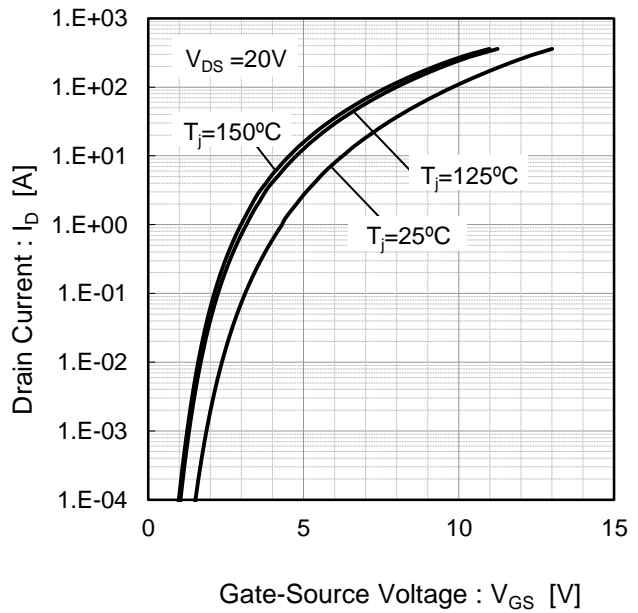

Fig.8 Drain Current vs. Gate-Source Voltage



●Electrical characteristic curves (Typical)

Fig.9 Switching Characteristics [$T_j=25^\circ\text{C}$]

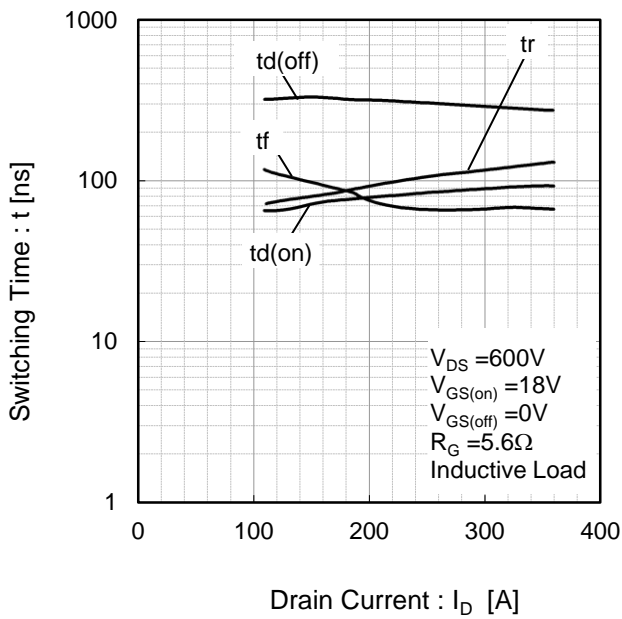

Fig.10 Switching Characteristics [$T_j=125^\circ\text{C}$]

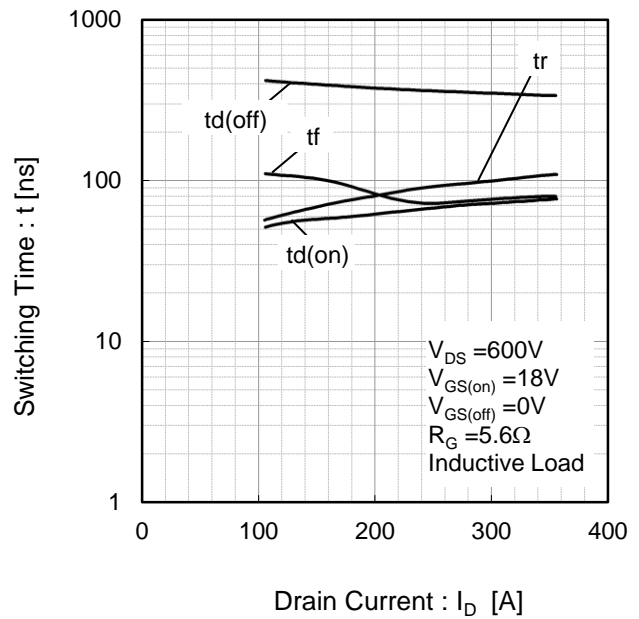

Fig.11 Switching Loss vs. Drain Current [$T_j=25^\circ\text{C}$]

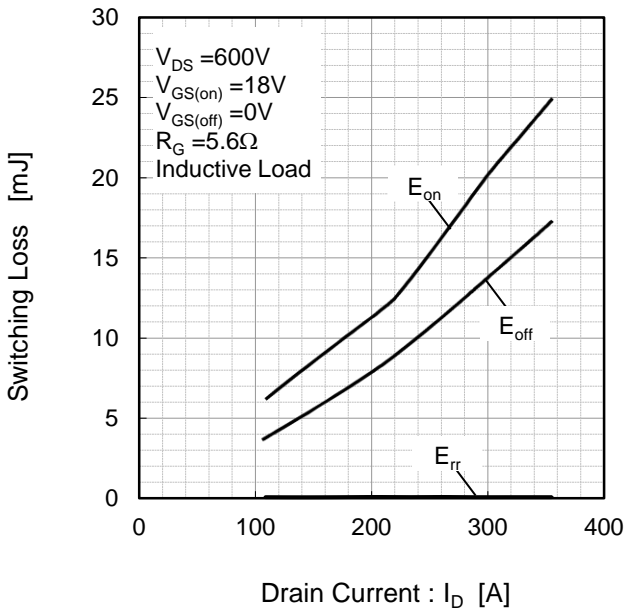
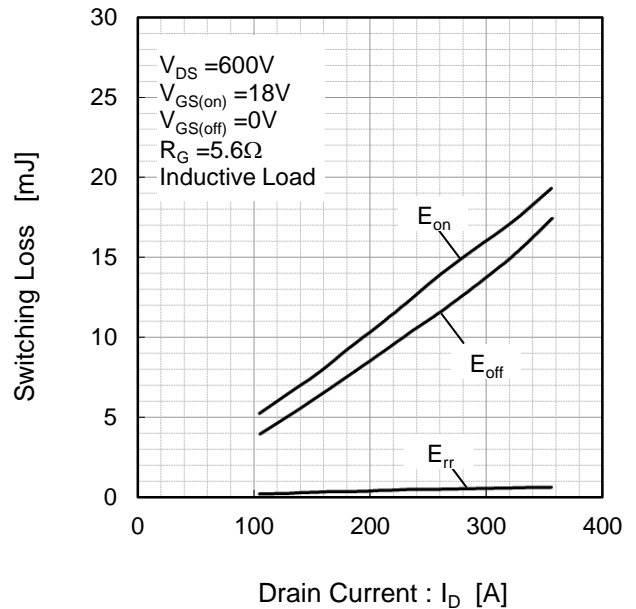

Fig.12 Switching Loss vs. Drain Current [$T_j=125^\circ\text{C}$]



●Electrical characteristic curves (Typical)

Fig.13 Recovery Characteristics vs. Drain Current [Tj=25°C]

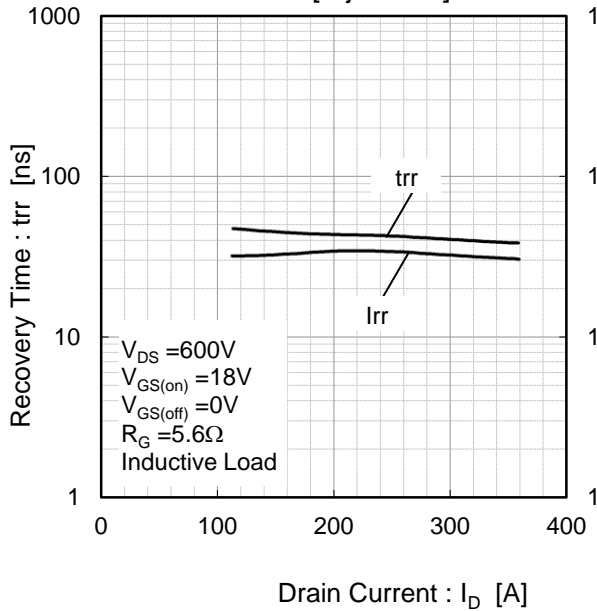

Fig.142 Recovery Characteristics vs. Drain Current [Tj=125°C]

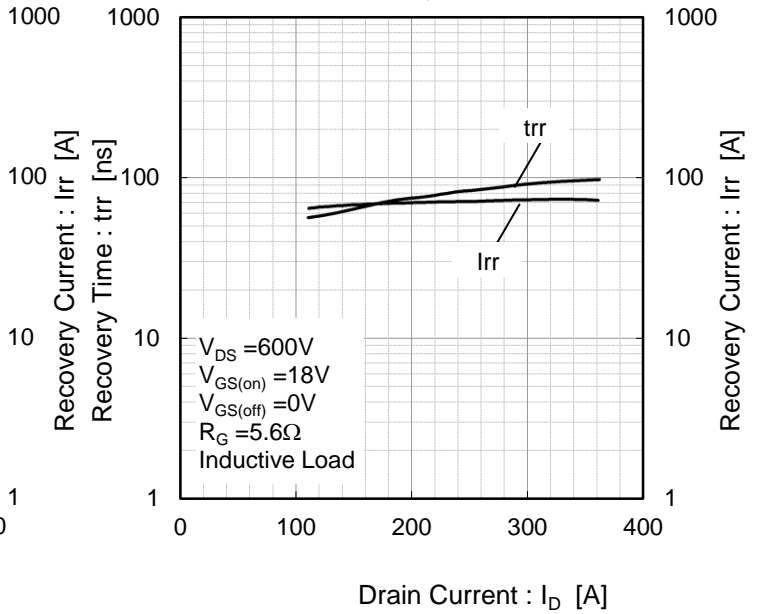

Fig.15 Switching Characteristics vs. Gate Resistance [Tj=25°C]

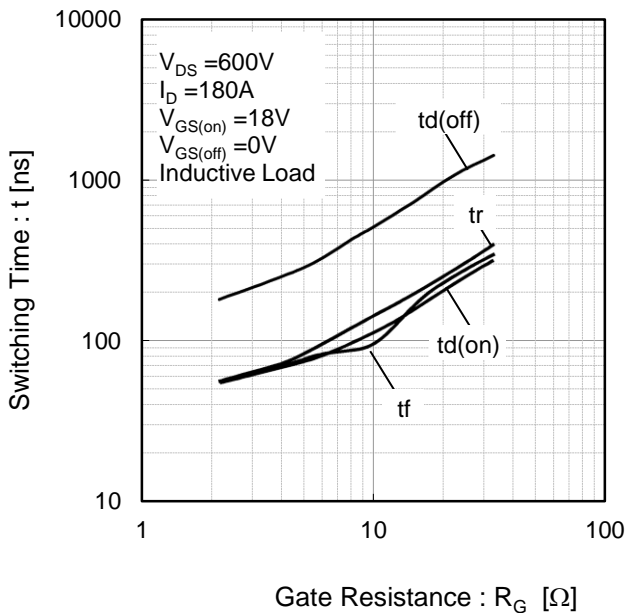
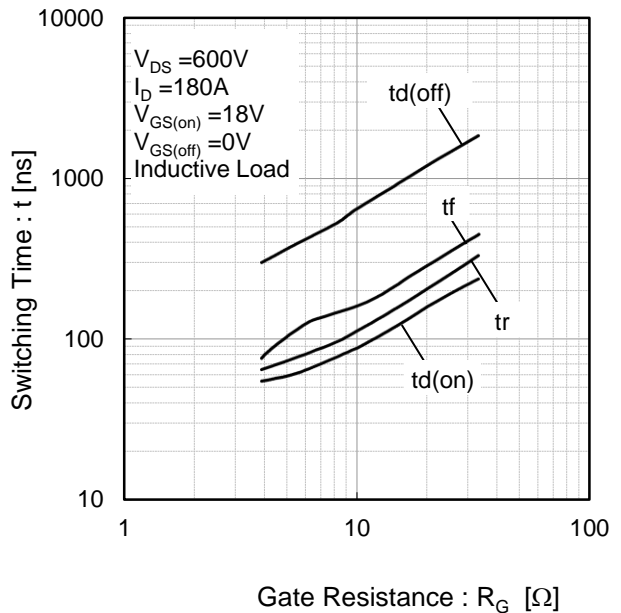

Fig.16 Switching Characteristics vs. Gate Resistance [Tj=125°C]



●Electrical characteristic curves (Typical)

Fig.17 Switching Loss vs. Gate Resistance [Tj=25°C]

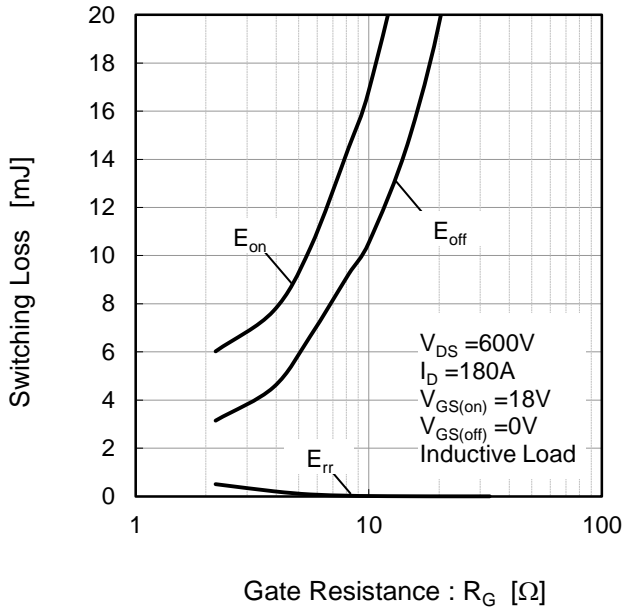

Fig.18 Switching Loss vs. Gate Resistance [Tj=125°C]

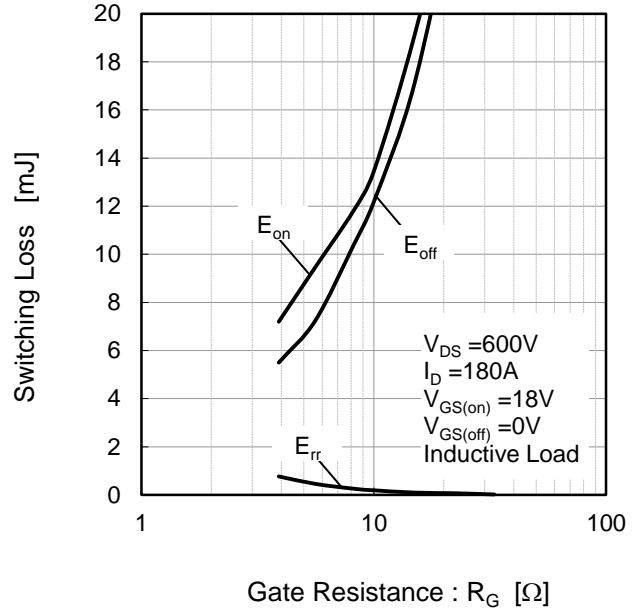

Fig.19 Typical Capacitance vs. Drain-Source Voltage

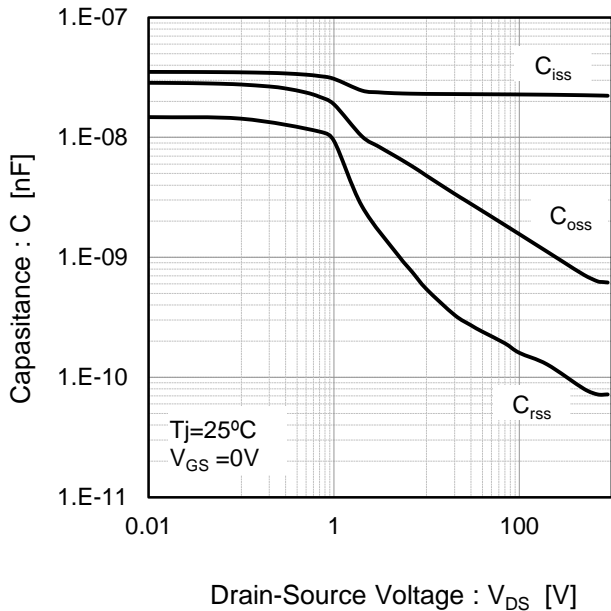
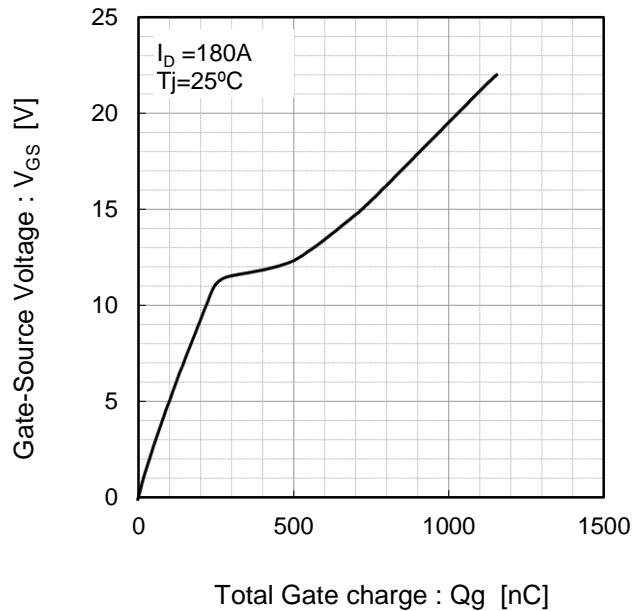
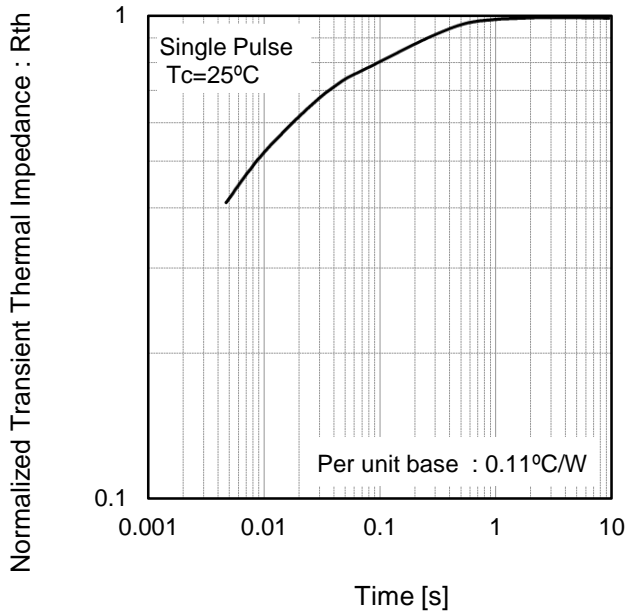

Fig.20 Gate Charge Characteristics [Tj=25°C]



●Electrical characteristic curves (Typical)

Fig.21 Normalized Transient Thermal Impedance



Notes

- 1) The information contained herein is subject to change without notice.
- 2) Before you use our Products, please contact our sales representative and verify the latest specifications :
- 3) Although ROHM is continuously working to improve product reliability and quality, semiconductors can break down and malfunction due to various factors.
Therefore, in order to prevent personal injury or fire arising from failure, please take safety measures such as complying with the derating characteristics, implementing redundant and fire prevention designs, and utilizing backups and fail-safe procedures. ROHM shall have no responsibility for any damages arising out of the use of our Products beyond the rating specified by ROHM.
- 4) Examples of application circuits, circuit constants and any other information contained herein are provided only to illustrate the standard usage and operations of the Products. The peripheral conditions must be taken into account when designing circuits for mass production.
- 5) The technical information specified herein is intended only to show the typical functions of and examples of application circuits for the Products. ROHM does not grant you, explicitly or implicitly, any license to use or exercise intellectual property or other rights held by ROHM or any other parties. ROHM shall have no responsibility whatsoever for any dispute arising out of the use of such technical information.
- 6) The Products specified in this document are not designed to be radiation tolerant.
- 7) For use of our Products in applications requiring a high degree of reliability (as exemplified below), please contact and consult with a ROHM representative : transportation equipment (i.e. cars, ships, trains), primary communication equipment, traffic lights, fire/crime prevention, safety equipment, medical systems, servers, solar cells, and power transmission systems.
- 8) Do not use our Products in applications requiring extremely high reliability, such as aerospace equipment, nuclear power control systems, and submarine repeaters.
- 9) ROHM shall have no responsibility for any damages or injury arising from non-compliance with the recommended usage conditions and specifications contained herein.
- 10) ROHM has used reasonable care to ensure the accuracy of the information contained in this document. However, ROHM does not warrant that such information is error-free, and ROHM shall have no responsibility for any damages arising from any inaccuracy or misprint of such information.
- 11) Please use the Products in accordance with any applicable environmental laws and regulations, such as the RoHS Directive. For more details, including RoHS compatibility, please contact a ROHM sales office. ROHM shall have no responsibility for any damages or losses resulting from non-compliance with any applicable laws or regulations.
- 12) When providing our Products and technologies contained in this document to other countries, you must abide by the procedures and provisions stipulated in all applicable export laws and regulations, including without limitation the US Export Administration Regulations and the Foreign Exchange and Foreign Trade Act.
- 13) This document, in part or in whole, may not be reprinted or reproduced without prior consent of ROHM.



Thank you for your accessing to ROHM product informations.
More detail product informations and catalogs are available, please contact us.

ROHM Customer Support System

<http://www.rohm.com/contact/>