

Cannon

SURE-SEAL Series



ITT

ENGINEERED FOR LIFE

Reliability. Low Cost.

Performance. Delivery.

SURE-SEAL connectors – a series of low cost and environmentally sealed connectors.

The one-piece molded body and rugged multiple moisture seals make the SURE-SEAL connector a natural for applications whose outside contaminants must be excluded.

One of the many features of the SURE-SEAL connector is its simplicity. In addition to the contacts, only two other parts – the connector bodies – are required to complete the interconnect.

Features

Low Installed Cost

SURE-SEAL connectors are designed to be terminated by the O.E.M.

Field Service

When necessary, SURE-SEAL connectors can be changed, modified or wired in the field.

One-Piece Molded Bodies

The SURE-SEAL connector incorporates a very simple one-piece molded body. No other parts – other than contacts – are needed to assemble a complete connector.

Low Cost Stamped Contacts

Without sacrificing quality, the cost of SURE-SEAL connectors is kept low with stamped contacts available on reels in a continuous strip for use on the industry accepted semi automatic crimp press with mini applicator. All contacts utilize a “B” type crimp.

Wide Wire Gage and Cable Accommodations

Ideally suited to be terminated on wires of size 0,4-1,5 mm² (AWG 14-20), wire sizes with insulation in the range of 1,4-1,8 for Mini Sure Seal, resp. 1,8 - 2,8 for Sure Seal, termination to multiconductor jacketed cables in the range of 5,3 to 12,4 mm diameter and can be terminated to five different wire ranges depending on contact arrangements with total environment sealing still assured.

Design

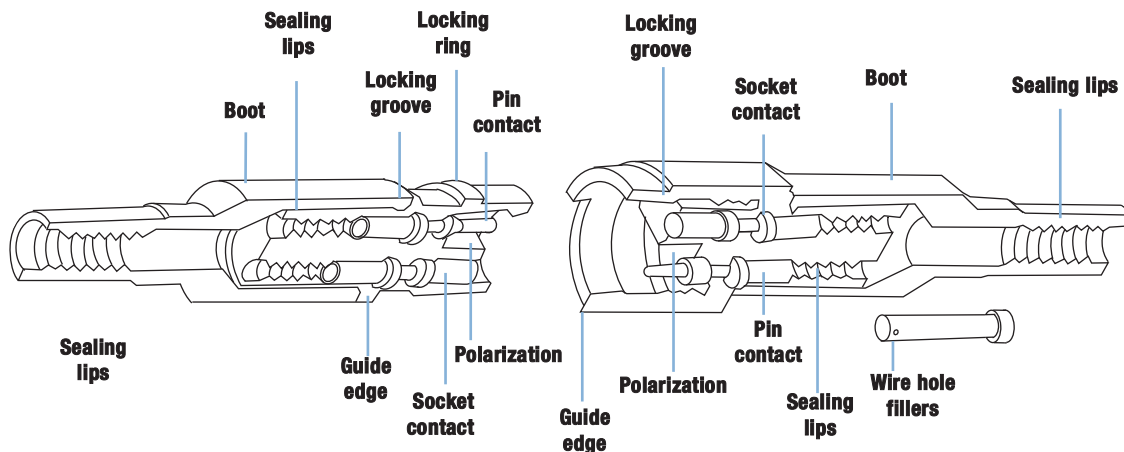

SURE-SEAL connectors were designed to meet the increased requirements for safety and reliability in the automotive field brought about by Department of Transportation regulations. These sealed connectors satisfy all of the parameters defined by automotive / industrial standards including vibration, shock, temperature cycling, salt water spray and immersion, petroleum derivatives, industrial gas, and most important low millivolt drop and low contact resistance.

Polarized Against Mis-Mates

SURE-SEAL connector mating faces are constructed with two stepped planes; the plug and receptacle must be properly oriented in order for the contacts to engage. For “blind” mating a raised indexing rib and matching raised indexing spline has been added to the plug and receptacle.

Water Submersible

Not just splash proof, but truly submersible for short periods of time. SURE-SEAL fulfills the requirements according to IP68, IEC 60529. Note: Although SURE-SEAL can withstand submersion, it is not designed to be an underwater connector.

Resistant to Automotive/Commercial Environment

SURE-SEAL connectors are designed to meet temperatures from – 40° C to 105° C under conditions of high humidity severe vibration, ice and mud. Sealing integrity is still maintained with exposure to brake fluid, gasoline, diesel fuel, anti-freeze, ultra violet, ozone, steam cleaning under normal operating conditions.

Environment & Health

RoHS compliant



The ITT “Engineered Blocks” symbol and the composite ITT logo are registered trademarks of ITT Corporation. © 2012.

ITT

Dimensions shown in mm
Specifications and dimensions subject to change

www.ittcannon.com

Interconnect Technologies & Solutions for the Transportation Industry

For over 90 years, ITT has been developing innovative solutions for harsh environment applications. We have a proven track record of demonstrating our expertise and commitment to the transportation industry, offering the broadest portfolio of interconnect products.

Our interconnect range include sealed circulars, plastic and metal shell bayonet coupling circulars, miniature metal shell circulars, PC board header connectors and sensor and direct device connectors. ITT is also a systems supplier, providing value-added module and harness assemblies.

In addition to the SURE-SEAL series, we also offer these connectivity solutions:



Cannon APD

In-line and bulkhead connectors are resistant to the harsh environmental conditions (contaminants, vibration and shock) and sealed up to IP69K.



Cannon CA-Bayonet

Signal and power connectors with exceptional sealing against the ingress of fluids and will withstand the effects of high vibrations.



Cannon Trident

Versatile range of electrical connectors based on a standard contact design. Options include: industrial grade, harsh environment and shielded circulars.



Cannon SLC/SLE

Environmentally sealed connector created for printed circuit board, black box, cable-to-cable or bulkhead applications.



Connector Series Selection Table		Sure Seal	CLC	SLC	SLE	APD	Trident Rectangular	Trident Circular	MS E/F/R
									
General	Industrial/Commercial	○	○	○	○	○	○	○	○
	Military	-	-	-	-	-	-	-	○
	Standards/Associated Specifications	-	SAE J2030 USCar	SAE J2030 USCar	SAE J2030 USCar	ISO 15170	UL 1977 NFF 61-030 (TFR)	UL 1977 EN 61984	MIL-DTL-5015 VG 95342
	Number of Circuits	2 to 10	2 & 4	5, 8, 10 & 15	19 & 28	1 to 51	2 to 36	4 to 48	1 to 65
Electrical	Max. Operating Voltage	48 V DC	300 V AC	300 V AC	300 V AC	48 V DC High Voltage: 500 V DC/AC	250 V AC	250 V AC High Voltage: 500 V DC/AC	50 V DC
	Dielectric Withstanding Voltage (at sea level)	1200 V AC	1000 V AC	1000 V AC	1000 V AC	1000 V AC High Voltage: 3500 V AC	2000 V AC	2000 V AC High Voltage: 3500 V AC	3000 V AC
	Max. Current Rating @ 40°C	17 A	5 A	13 A	13 A	245 A	13 A	30 A	245 A
	EMI/RFI Shielding	-	-	-	-	-	-	○	○
Mechanical	Wire Gauge Range AWG	20 to 14	20 to 16	20 to 16	20 to 16	22 to 0	26 to 14	26 to 12	26 to 0
	Wire Gauge Range mm ²	0,4 - 1,5 mm ²	0,50 - 1,0 mm ²	0,50 - 1,0 mm ²	0,50 - 1,0 mm ²	0,35 - 50 mm ²	0,14 - 2,5 mm ²	0,14 - 4,0 mm ²	0,14 - 50 mm ²
	Power & Signal Layouts	-	-	-	-	-	-	○	○
	Mating Cycles (max.)	100	25	25	25	50	500	500	100
	Type of Coupling	Ring Snap	Clip Lock	Snap Lock	Snap Lock	Bayonet	Snap Lock	Bayonet	Thread
	Mechanical Coding	-	-	-	○	○	○	○	-
Environmental	Environmental Sealing (mated condition)	IP 68 (1 bar / 12h)	IP 68	IP 68	IP 68	IP67 IP69k	IP 20	IP 67	IP 65
	Operating Temperature	-40°C to 105°C -40°F to 221°F	-40°C to 150°C -40°F to 302°F	-40°C to 150°C -40°F to 302°F	-40°C to 125°C -40°F to 257°F	-40°C to 125°C -40°F to 257°F	-55°C to 105°C -67°F to 221°F	-55°C to 125°C -67°F to 257°F	-55°C to 125°C -67°F to 257°F
	Shock Test (g's)	50	100	100	100	-	50	50	50
	Max. Vibration Resistance	10 - 55 Hz 1,5 mm	100 m/s ² 10 g's	100 m/s ² 10 g's	100 m/s ² 10 g's	300 m/s ² 30 g's	100 m/s ² 10 g's	100 m/s ² 10 g's	100 m/s ² 10 g's
	Individual Wire Sealing	○	○	○	○	○	-	○	○
	Cable Jacket Sealing	○	-	-	-	○	-	○	○
	Shell Material	Nitril-Butadien Elastomer	Thermoplastic	Thermoplastic	Thermoplastic	Polyamide Plastic	Polyamide Plastic	Black Nylon or Zinc Alloy	Aluminum Alloy
Shell Plating	RoHS Nickel (48h salt spray)	-	-	-	-	-	-	○	○
	Cadmium (olive, 500h)	-	-	-	-	-	-	-	○
	RoHS Zinc Cobalt (black, 200h)	-	-	-	-	-	-	-	○
	Zinc Cobalt (green, 200h)	-	-	-	-	-	-	-	-
	RoHS Zinc Nickel (blue, 500h) BLUE GENERATION®	-	-	-	-	-	-	-	-
Contacts	Contact Plating	Tin or Silver	Tin or Gold	Tin or Gold	Tin or Gold	Tin, Silver or Gold	Tin or Gold	Tin or Gold	Silver or Gold
	Crimp, machined	○	○	○	○	○	○	○	-
	Crimp, stamped	○	○	○	○	○	○	○	-
	Solder	-	-	-	-	○	○	○	○
	Printed Circuit Solder	-	○	○	○	○	○	○	○
	Co-Ax	-	-	-	-	-	○	○	-
	Fiber Optic	-	-	-	-	-	-	-	-
	First-Mate Last-Break	-	-	-	-	-	○	○	○
			○ Available	- Not available					

Dimensions shown in mm
Specifications and dimensions subject to change

CA Bayonet	CA-INDUSTRIAL	CA Triple Thread	CGL	KPT / KPSE	KPTC	PV	KJL	KJ	KJA
○	○	○	○	○	○	-	○	○	○
○	-	-	-	○	○	○	○	○	○
VG 95234	-	ISO 16750 VG 95234	DIN/VDE 0627 5.4.3 IEC 512-25-1 DIN/VDE 0100 Part 410	MIL-DTL-26482 Series 1, VG 95328	MIL-DTL-26482 Series 1, VG 95328	MIL-DTL 26482 Series 2	MIL-DTL-38999 Series I	MIL-DTL-38999 Series II	MIL-DTL-38999 Series III
1 to 85	2 to 55	1 to 85	3 to 11	2 to 61	2 to 61	3 to 61	3 to 128	3 to 128	3 to 128
50 V DC	50 V DC	50 V DC	700 V DC	50 V DC	50 V DC	500 V AC	1250 V AC	1250 V AC	1250 V AC
3000 V AC	2000 V AC	3000 V AC	7200 V AC	2300 V AC	2300 V AC	2300 V AC	2300 V AC	2300 V AC	2300 V AC
245 A	30 A	245 A	100 A	22 A	22 A	23 A	23 A	23 A	23 A
○	○	○	○	○	○	○	○	○	○
26 to 0	26 to 12	26 to 0	15 to 3	24 to 16	24 to 16	24 to 12	28 to 12	28 to 12	28 to 12
0,14 - 50 mm ²	0,14 - 4,0 mm ²	0,14 - 50 mm ²	1,5 - 25 mm ²	0,21 - 1,91 mm ²	0,4 - 2,0 mm ²	0,4 - 5,0 mm ²	0,45 - 5,0 mm ²	0,45 - 5,0 mm ²	0,45 - 5,0 mm ²
○	○	○	○	-	-	○	○	○	○
500	200	500	500	500	500	500	500	500	500
Reverse Bayonet	Reverse Bayonet	Triple Thread	Bayonet	Bayonet	Bayonet	Bayonet	Bayonet	Bayonet	Triple Thread
○	○	○	○	○	○	-	-	-	-
IP68 (1 bar / 16h) IP69k	IP68 (1 bar / 16h) IP69k	IP68 (1 bar / 16h) IP69k	IP 67	IP 68 (0,2 bar / 48h)	IP 68 (0,2 bar / 48h)	Environmental resistant acc. to EIA-364-02	Environmental resistant acc. to EIA-364-02	Environmental resistant acc. to EIA-364-02	Environmental resistant acc. to EIA-364-02
-55°C to 125°C -67°F to 257°F	-55°C to 125°C -67°F to 257°F	-55°C to 125°C -67°F to 257°F	-50°C to 140°C -58°F to 284°F	-55°C to 125°C -67°F to 257°F	-55°C to 125°C -67°F to 257°F	-55°C to 200°C -67°F to 392°F	-65°C to 200°C -85°F to 392°F	-65°C to 200°C -85°F to 392°F	-65°C to 200°C -85°F to 392°F
50	50	50	50	50	50	10	300	300	300
200 m/s ² 20 g's	100 m/s ² 10 g's	300 m/s ² 30 g's	300 m/s ² 30 g's	200 m/s ² 20 g's	200 m/s ² 20 g's	200 m/s ² 20 g's	300 m/s ² 30 g's	10Hz - 500Hz Random: 43,7g	600m/s ² 60g'
○	-	-	-	○	○	○	○	○	○
○	○	○	○	○	○	○	○	○	○
Aluminum Alloy	Aluminum Alloy	Aluminum Alloy	Aluminum Alloy	Aluminum Alloy	Aluminum Alloy	Aluminum Alloy	Aluminum Alloy	Aluminum Alloy	Aluminum Alloy
○	○	○	○	○	○	○	○	○	○
○	-	○	-	○	○	○	○	○	○
○	-	○	-	○	○	-	-	-	○
○	-	○	-	○	○	-	-	-	-
○	○	○	○	○	○	-	-	-	-
Silver or Gold	Tin or Gold	Silver or Gold	Silver or Gold	Gold	Gold	Gold	Gold	Gold	Gold
○	-	○	○	○ (KPSE)	○	○	○	○	○
-	○	-	-	-	-	-	-	-	-
○	-	○	○	○ (KPT)	○	-	-	-	○
○	-	○	-	○	○	○	○	○	○
-	-	-	-	○	-	○	○	○	○
-	-	-	-	-	-	○	○	○	○
○	-	○	-	○	○	-	-	-	-

Dimensions shown in mm
Specifications and dimensions subject to change

www.ittcannon.com

Table of Contents

Introduction	2
Features	2
Connector Series Selection Table	4-5
Mini SURE-SEAL	
Technical Data	7
Contact Arrangements	
Part Numbers	
Measurements	8-9
SURE-SEAL	
Technical Data	10
Contact Arrangements	
Part Numbers	
Measurements	11-14
SURE-SEAL Accessories	15-16
Tools	17-26
Wiring Instructions	27-28
Part Number Index	29
Product Safety Information	30

Electrical Data

Operating Voltage	48 VDC*
Operating Current	see derating curve
Contact Resistance	10 Milliohms max.
Dielectric Withstanding Voltage	1200 VAC at sea level
Insulation Resistance	100 Megaohms min.

Wire Dimensions

Wire Range	0,4– 0,75 mm ² (AWG 20–18)
Wire Insulation	
Sealing Range	1,4– 1,8 mmØ

Mechanical Data

No. of contacts per connector	2 to 4
Polarization	Stepped plane positive polarization and visual polarization
Contact Retention	30 N minimum
Durability	50 mating cycles with stamped contacts, tin-plated 100 mating cycles with machined contacts, silver-plated

Environmental Data

Temperature Range	-40°C to 105°C
Humidity Range	up to 95% r.h.
Sealing	IP 68 (100 kPa = 1 bar/12 h) (IEC 60529)
Salt Spray	100 h (DIN 50021, test SS)
Vibration	Sine wave 10-55 Hz, 1,5mm (IEC 60512-4, test 6d)
Physical Shock	Half sine 500 m/s ² ; 11ms
Fluid Compatability	Fuel, engine oil, break fluid, detergent fluid and others
Ozone Resistance	50 pphm, 48 h (DIN 53509-1)

*Further information available upon request

Materials and Finishes

Plug and Receptacle	Nitril-Butadien rubber
Contacts, stamped	Copper alloy, tin plating
Contacts, machined	Copper alloy, hard silver plating

Applications

Industrial Machinery
Rail
Construction & Cleaning Vehicles
Trucks & Busses
Cranes



Current rating - Mini SURE-SEAL

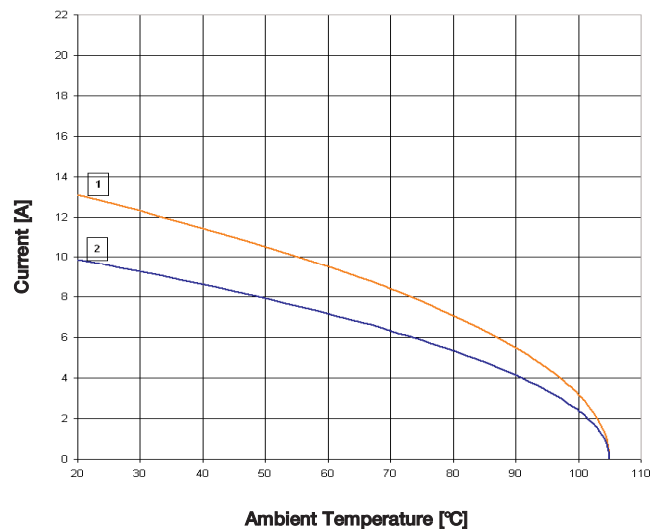

— 1: 2-way connector, wire size 0,75mm²
— 2: 2-way connector, wire size 0,4mm²

Connector fully equipped with stamped contacts

Mini SURE-SEAL

Contact Arrangements

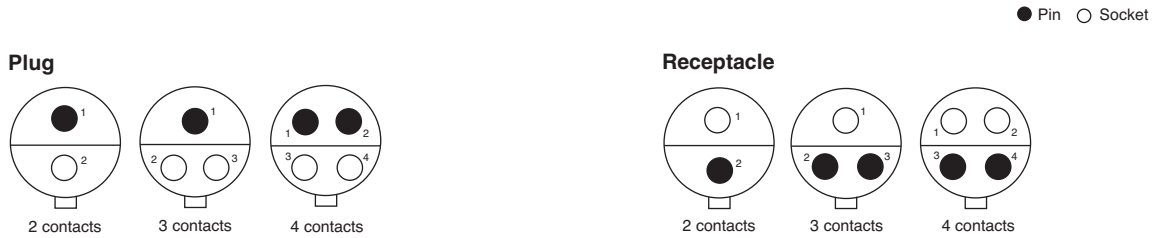

Part Numbers



Plug			
No. of contacts	Shell size	black	
2	MSS 2 P	120-8552-100	
3	MSS 3 P	120-8552-101	
4	MSS 4 P	120-8552-102	

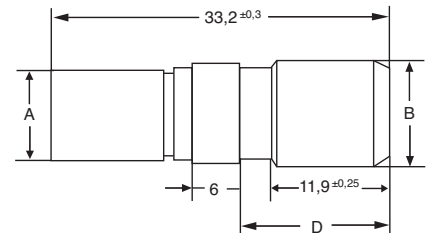

Receptacle			
No. of contacts	Shell size	black	
2	MSS 2 R	120-8551-100	
3	MSS 3 R	120-8551-101	
4	MSS 4 R	120-8551-102	

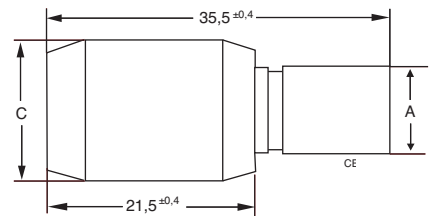

Measurements

Shell size	ØA ± 0,15	ØB - 0,2	ØC - 0,3	ØD ± 0,3
MSS 2 P/R	8,2	9,6	13,4	16,3
MSS 3 P/R	8,8	10,4	14,4	13,4
MSS 4 P/R	8,8	11,0	15,0	13,4



Dimensions shown in mm
Specifications and dimensions subject to change

www.ittcannon.com

Contacts, stamped

With insulation support

			Pins	Sockets	Wire hole fillers
Mini SURE-SEAL	0,4–0,75 mm ²	individual	330-8672-100	031-8703-100	225-1012-000
		on reels, 5000 pcs.	121348-0100	121347-0100	225-1012-000

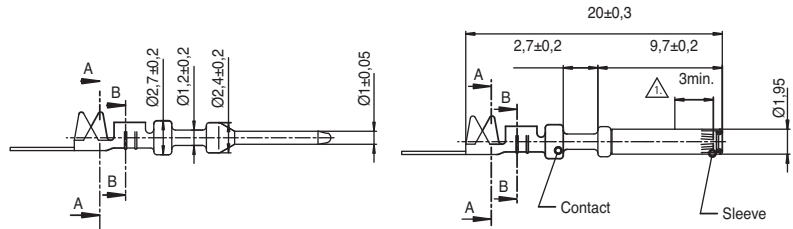
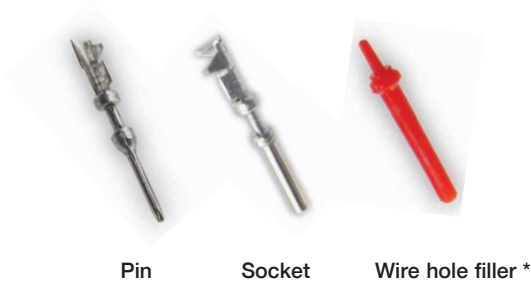

* Wire hole fillers are inserted into unused cavities instead of a contact in order to create a watertight sealing.

Contacts, machined

			Pins	Sockets	Wire hole fillers
Mini SURE-SEAL	0,4–0,75 mm ²	individual	330-8672-005	031-8703-052	225-1012-000

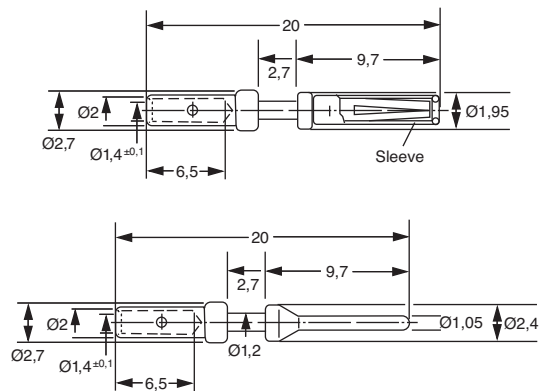
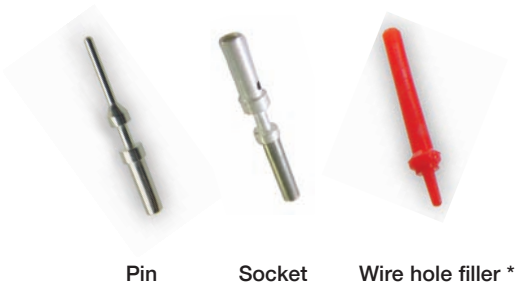

* Wire hole fillers are inserted into unused cavities instead of a contact in order to create a watertight sealing.

Electrical Data

Operating Voltage	48 VDC*
Operating Current	see derating curve
Contact Resistance	10 Milliohms max.
Dielectric Withstanding Voltage	1200 VAC at sea level
Insulation Resistance	100 Megaohms min.

Wire Dimensions

Wire Range	0,75– 1,5 mm ² (AWG 18–14) 0,5-1,0 mm ² (AWG 20–16)
Wire insulation Sealing Range	1,8– 2,8 mmØ

Mechanical Data

No. of contacts per connector	2 to 10
Polarization	Stepped plane positive polarization and visual polarization
Contact Retention	35 N minimum
Durability	50 mating cycles with stamped contacts, tin-plated 100 mating cycles with machined contacts, silver-plated

Environmental Data

Temperature Range	-40°C to 105°C
Humidity Range	up to 95% r.h.
Sealing	IP 68 (100 kPa = 1 bar/12 h) (IEC 60529)
Salt spray	100 h (DIN 50021, test SS)
Vibration	Sine wave 10-55 Hz, 1,5mm (IEC 60512-4, test 6d)
Physical Shock	Half sine 500 m/s ² 11ms
Fluid Compatability	Fuel, engine oil, break fluid, detergent fluid and others
Ozone Resistance	50 pphm, 48 h (DIN 53509-1)

Materials and Finishes

Plug and Receptacle	Nitril-Butadien rubber
Contacts, stamped	Copper alloy, tin plating
Contacts, machined	Copper alloy, hard silver plating

Applications

- Industrial Machinery
- Rail
- Construction & Cleaning Vehicles
- Trucks & Busses
- Cranes



Current rating - SURE-SEAL

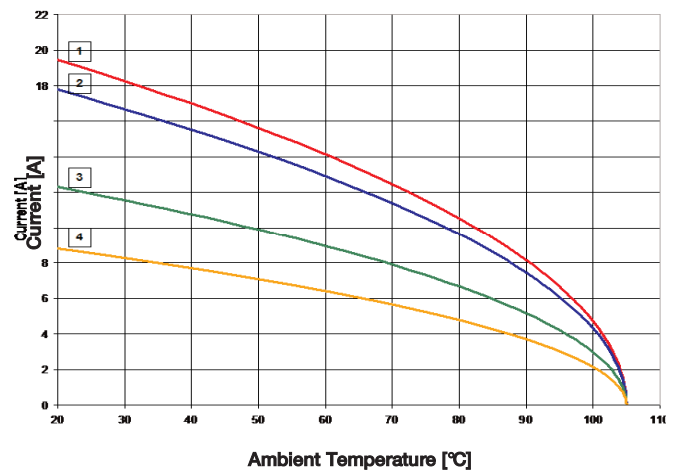

- 1: 2-way connector, wire size 1,5mm²
- 2: 7-way connector, wire size 1,5mm²
- 3: 2-way connector, wire size 0,5mm²
- 4: 7-way connector, wire size 0,5mm²

Connector fully equipped with stamped contacts

*Further information available upon request

Plug

Contact Arrangements

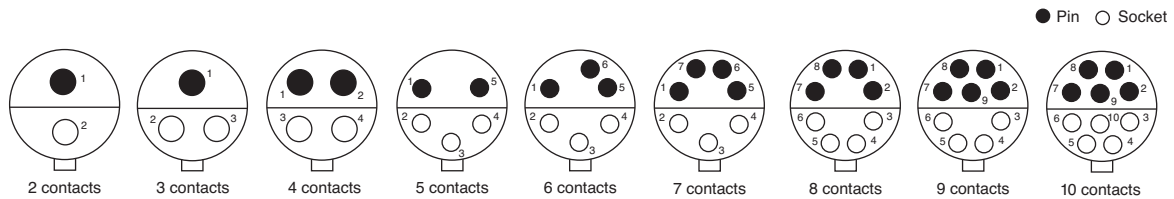

Part Numbers

2, 3 and 4 Contacts



No. of contacts	Shell size	Part No.	A - 0,3	B - 0,3	Insulation Ø
2	SS2P	120-8552-000	13,9	10,9	1,8 - 2,8
3	SS3P	120-8552-001	15,2	12,3	1,8 - 2,8
4	SS4P	120-8552-002	15,2	12,3	1,8 - 2,8

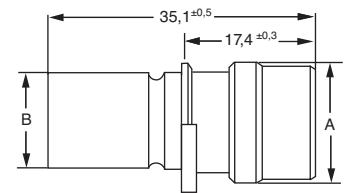

5, 6 and 7 Contacts



No. of contacts	Shell size	Part No.	A - 0,3	B - 0,3	Insulation Ø
5	SS5P	120-8552-005	25,3	20,2	1,8 - 2,8
6	SS6P	120-8552-006	25,3	20,2	1,8 - 2,8
7	SS7P	120-8552-007	25,3	20,2	1,8 - 2,8

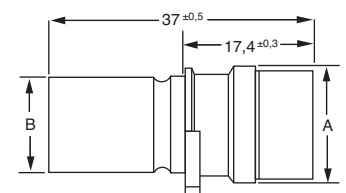

8 to 10 Contacts



No. of contacts	Shell size	Part No.	A ± 0,3	B ± 0,2	Insulation Ø
8	SS8P	120-8552-308	28,55	23,5	1,8 - 2,8
9	SS9P	120-8552-309	28,55	23,5	1,8 - 2,8
10	SS10P	120-8552-310	28,55	23,5	1,8 - 2,8

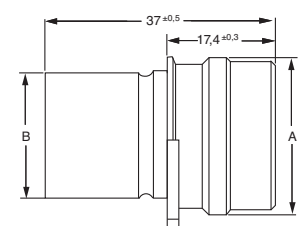

Plug with flange

Contact Arrangements

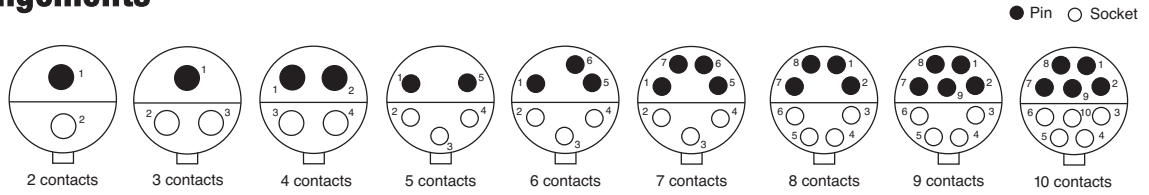

Part Numbers

2, 3 and 4 Contacts



No. of contacts	Shell size	Part No.	A - 0,3	B - 0,3	Insulation Ø
2	SSF2P	120-8552-200	13,9	10,8	1,8 - 2,8
3	SSF3P	120-8552-201	15,2	12,3	1,8 - 2,8
4	SSF4P	120-8552-202	15,2	12,3	1,8 - 2,8

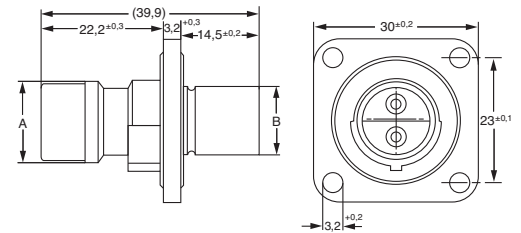

8, 9 and 10 Contacts



No. of contacts	Shell size	Part No.	A ± 0,3	B ± 0,2	Insulation Ø
8	SSF8P	120-8552-305	28,55	23,5	1,8 - 2,8
9	SSF9P	120-8552-306	28,55	23,5	1,8 - 2,8
10	SSF10P	120-8552-307	28,55	23,5	1,8 - 2,8

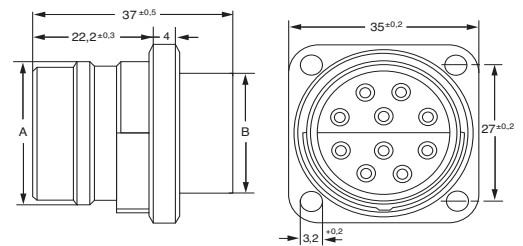

Receptacle

Contact Arrangements

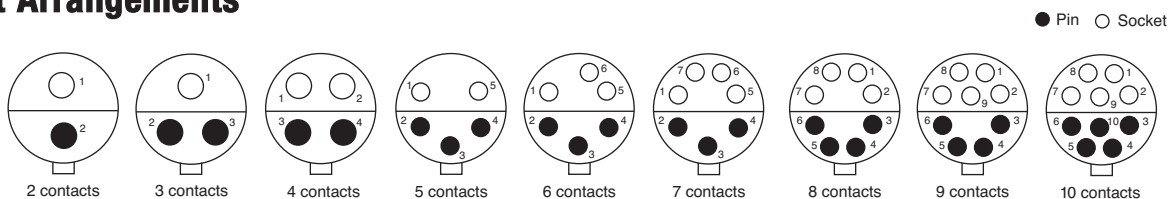

Part Numbers



No. of contacts	Shell size	Part No.	A - 0,5	B - 0,3	Insulation Ø
2	SS2R	120-8551-000	18,0	10,9	1,8 - 2,8
3	SS3R	120-8551-001	18,9	12,3	1,8 - 2,8
4	SS4R	120-8551-002	18,9	12,3	1,8 - 2,8

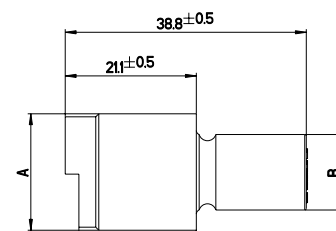

No. of contacts	Shell size	Part No.	A - 0,5	B - 0,3	Insulation Ø
5	SS5R	120-8551-005	29,1	20,2	1,8 - 2,8
6	SS6R	120-8551-006	29,1	20,2	1,8 - 2,8
7	SS7R	120-8551-007	29,1	20,2	1,8 - 2,8

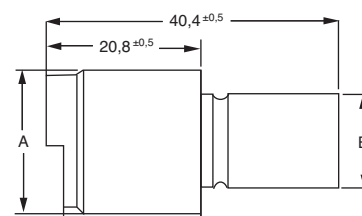

No. of contacts	Shell size	Part No.	A - 0,5	B ± 0,3	Insulation Ø
8	SS8R	120-8551-308	33,5	23,5	1,8 - 2,8
9	SS9R	120-8551-309	33,5	23,5	1,8 - 2,8
10	SS10R	120-8551-310	33,5	23,5	1,8 - 2,8

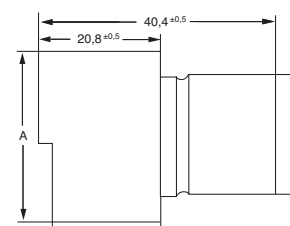

SURE-SEAL

Contacts, stamped

with insulation support

		Pins	Sockets	Wire hole fillers
SURE-SEAL 0,5– 1,0 mm ²	individual	330-8672-001	031-8703-001	225-0093-000
	on reels, 5000 pcs.	121348-0020	121347-0020	
SURE-SEAL 0,75– 1,5 mm ²	individual	330-8672-000	031-8703-000	
	on reels, 5000 pcs.	121348-0010	121347-0010	



Pin Socket Wire hole filler *

* Wire hole fillers are inserted into unused cavities instead of a contact in order to create a watertight sealing.

Contacts, machined

without insulation support

		Pins	Sockets	Wire hole fillers
SURE-SEAL 0,5– 1,0 mm ²		330-8672-002	031-8703-050	225-0093-000
SURE-SEAL 0,75-1,5 mm ²		330-8672-003	031-8703-051	



Pin Socket Wire hole filler *

* Wire hole fillers are inserted into unused cavities instead of a contact in order to create a watertight sealing.

Mounting plate

For SURE-SEAL with flange Steel, zinc finish

Mounting Dimensions

Front and rear panel mounting

Order ref. 066-8516-002

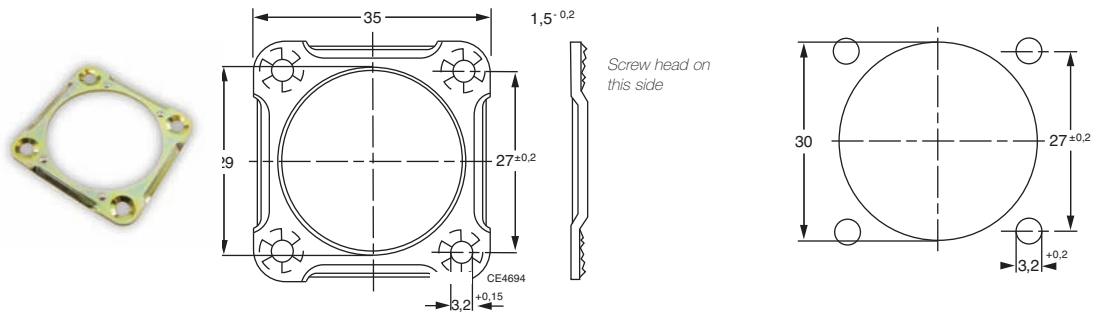

Order ref. 066-8516-000

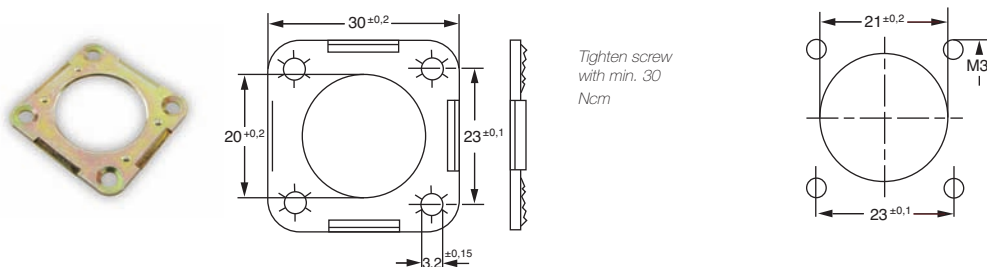

Dimensions shown in mm
Specifications and dimensions subject to change

www.ittcannon.com

Accessories

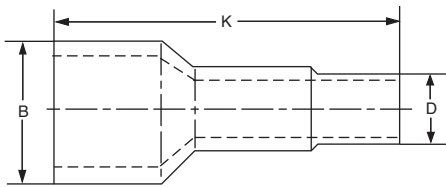

Boot

Seals wired cable jackets to connector housing. It also provides abrasion resistance.

For connector size	Order ref.	B Ømax.	D Ømax.	outer cable Ø	K max.
2 contacts	317-1398-000	17,00	9,70	5,28 – 5,79	52,07
3/4 contacts	317-1397-000	15,80	9,70	5,59 – 6,10	52,50
3/4 contacts	317-1399-000	19,40	12,90	8,76 – 9,65	52,07
5/7 contacts	317-8657-000	27,60	12,50	7,20 – 8,40	62,00
8/9/10 cont.	317-8657-002	31,50	17,50	10,00 – 12,40	64,00

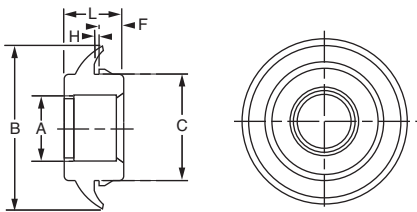

Grommet

Grommets enable panel mounting of either plugs or receptacle. It snaps into a hole of a panel so non-flanged plugs or receptacles can be mounted.

For connector size	Order ref.	A Ømax.	B Ømax.	C Ømax.	F max.	H	L max.
2 contacts	351-1640-000	10,41	32,39	19,18	5,84	1,40	17,53
3/4 contacts	351-1641-000	11,94	32,39	19,18	5,84	1,40	17,53
5/6/7 contacts	351-1633-000	19,43	55,88	36,70	8,00	1,65	20,57
8/9/10 cont.	351-1634-000	22,61	55,88	36,70	8,00	1,65	20,57

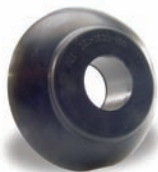

Wire Fillers

Wire hole fillers are inserted into unused cavities instead of a contact in order to create a watertight sealing.



Wire hole filler
Mini SURE-SEAL
Part Number 225-1012-000

Wire hole filler
SURE-SEAL
Part Number 225-0093-000

Accessories Clip/Clamp

Clips/Clamps can be used as an extra lock to secure two connector halves. Due to its design it also offers the possibility for fixed mounting a mated pair by using a screw or a cable tie.

Clamp

Clamps, plug and receptacle in mated condition

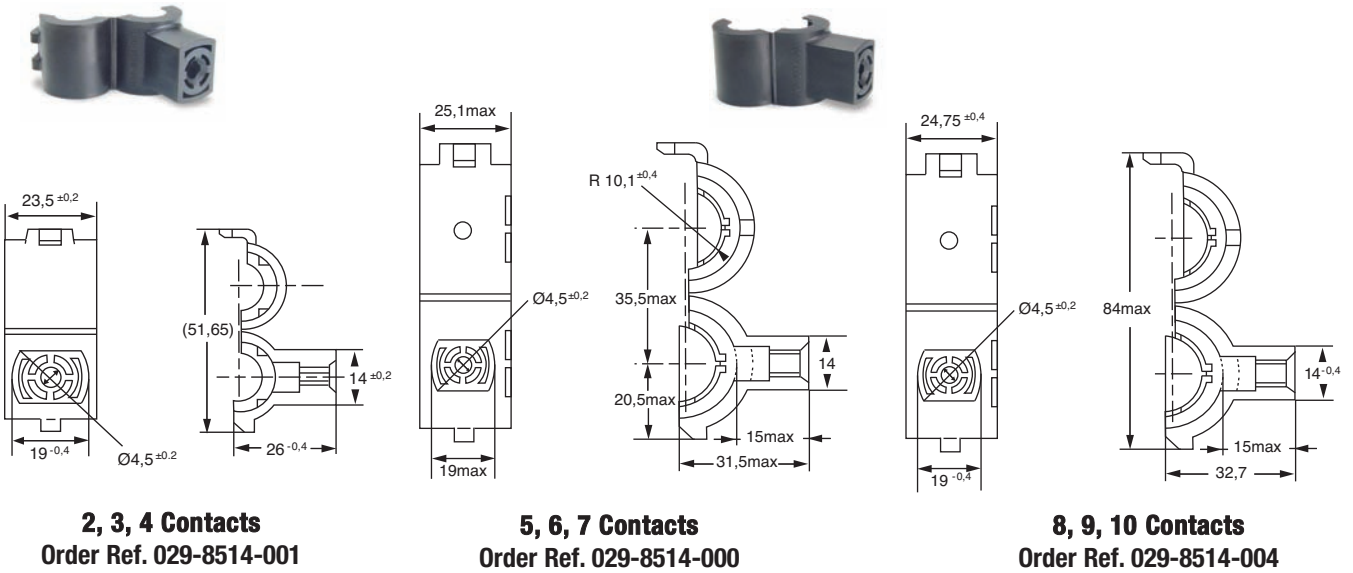

Mounting Clip

Clamps, plug and receptacle in mated condition

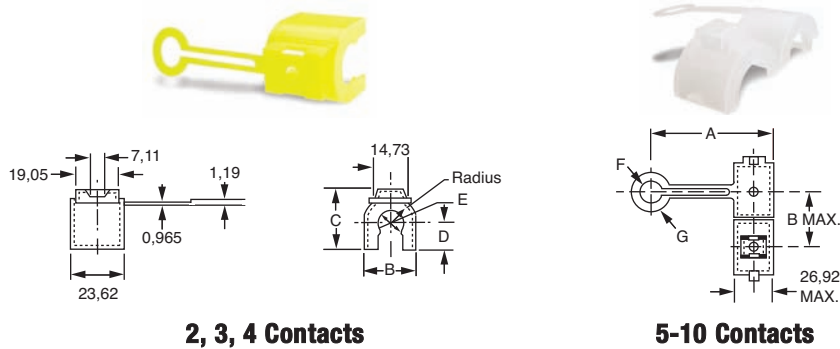

Connector size	Color of clip	Order ref.	A max.	B	C	D	E Ø	F max.	G max.
2 contacts	Red	029-0263-000	-	22,61	25,40	10,67	10,7	-	-
3/4 contacts	Yellow	029-0262-000	-	23,62	26,67	11,43	12,19	-	-
5/6/7 contacts	Natural	026-0450-000	77,34	35,43	-	-	-	15,49	23,11
8/9/10 contacts	Black	026-0451-000	77,34	38,61	-	-	-	16,76	24,38

Hand Crimp Tool CCT

for stamped contacts



Crimp tool	Order no.	Contact size	Pin contact	Socket contact	Stripping length mm	Outer wire insulation Ø
CCT-MSS/SS-20	121586-0085	SS-20	330-8672-001	031-8703-001	3,6-3,8	1,8-2,4
CCT-MSS/SS-20	121586-0085	MSS-100	330-8672-100	031-8703-100	3,3-3,6	1,4-1,8
CCT-SS-10	121086-3225	SS-10	330-8672-000	031-8703-000	5,0-5,5	1,8-2,8

Instructions

- Strip wire (neither twist nor touch stripped section)



- Insert single contact in correct crimp profile and locate onto wire stop (refer to table for outer insulation diameter).
- Close hand crimp tool until it holds contact in place.
- Insert pre-stripped wire until light contact is made on wire stop, and lay wire into contact barrels.
- Fully close hand crimp tool until ratchet releases.
- Remove contact.
- Inspect crimped area visually.

Dimensions shown in mm
Specifications and dimensions subject to change

www.ittcannon.com

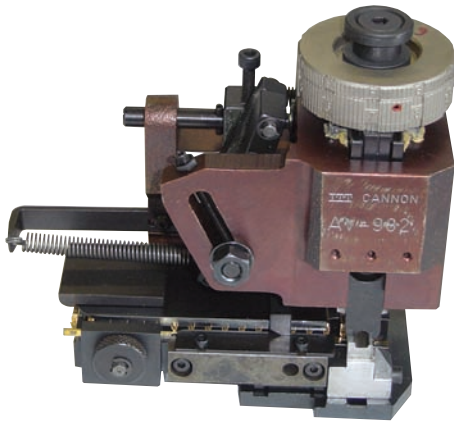

ITT Cannon Mini Applicator

for semi-automatic and automatic crimp machines

Cannon Mini Applicator can be exchanged easy, quick and effortless. The compact construction as well as the clamping device allow using the Mini Applicator with other crimp machines.

Technical Data

Lift	40 mm
Wire size to be processed	max 4mm ²
Installation dimension (lower dead center)	135.78 +/- 0,02 mm

Contacts

Contacts for the different connector series are available on reels. They can be terminated with the tool on the Basic Crimp Press TT (part number 121586-5225).

Quick Change Tool	Part Number	Contacts	Contacts per reel	Termination range mm ²
WWZ-EVS-SS-10	121586-5215	Sure Seal	5,000	0,75 - 1,5
WWZ-EVS-SS-20	121586-5216	Sure Seal	5,000	0,5 - 1,0
WWZ-EVS-MSS	121586-5214	Mini Sure Seal	5,000	0,4 - 0,75

Adjustments for the tools - please refer to the datasheet supplied with the tool.

Hand Crimp Tool M22520-1-01

for machined contacts



Crimp tool	Contacts	Contact Size	Positioner	Wire size		Stripping Length mm
				Pin and Socket mm	AWG	
M22520-1-01 Part Number: 995-0001-585	330-8672-003 031-8703-051	SS10	120090-0114	0,75-1,5		6,5 ^{+0,3}
	330-8672-009 330-8672-002 031-8703-050 031-8703-055	SS20	120090-0114	0,5-1,0		6,5 ^{+0,3}
	330-8672-008 031-8703-054	SS	120090-0114		12-14	6,5 ^{+0,3}
	330-8672-005 031-8703-052	MSS-100	120090-0114	0,4-0,75		5,2 ^{+0,2}



Pneumatic Crimp Tool WA27F-CE

for machined contacts

This tool is designed for 8-indent crimps. For insertion and removal of contact insert please refer to tool description.

Specifications

Air pressure 5.7-6.3 bar
Weight 4 kg

Sequence

- Mount correct contact positioner.
- Adjust tool for correct wire size using reference gauge (refer to table).
- Place contact in correct positioner.
- Insert stripped wire into crimp bore hole of contact.

Order numbers

Crimp tool	Contacts	Contact Size	Positioner	Wire size		Stripping Length mm
				Pin and Socket mm ²	AWG	
WA27F-CE Part Number: 121586-5067	330-8672-003 031-8703-051	SS10	120090-0114	0,75-1,5		6,5 ^{+0,3}
	330-8672-009 330-8672-002 031-8703-050 031-8703-055	SS20	120090-0114	0,5-1,0		6,5 ^{+0,3}
	330-8672-008 031-8703-054	SS	120090-0114		12-14	6,5 ^{+0,3}
	330-8672-005 031-8703-052	MSS-100	120090-0114	0,4-0,75		5,2 ^{+0,2}

Bench Mount: BM-2 121586-5068
Foot Pedal: WA10 121586-5069

Dimensions shown in mm
Specifications and dimensions subject to change

www.ittcannon.com



Semi-Automatic Crimp Machine HACS-5

for machined contacts

Machined contacts can be terminated quickly and efficiently with the Cannon semi-automatic crimp machine HACS-5.

Specifications

Power supply	220 V/Hz
Air pressure	min. 6 bar
Dimensions	600 x 600 mm
Weight	approx. 82 kg

For operating the machine and adjusting the crimp depth please refer to separate operating instructions

Crimp machine	Contacts	Contact Size	Wire size		Stripping Length mm
			Pin and Socket mm ²	AWG	
HACS-5-SS	330-8672-003 031-8703-051	SS10	0,75-1,5		6,5 ^{+0,3}
	330-8672-009 330-8672-002 031-8703-050 031-8703-055	SS20	0,5-1,0		6,5 ^{+0,3}
HACS-5-SS-12/14 *	330-8672-008 031-8703-054	SS		12-14	6,5 ^{+0,3}
HACS-5-MSS *	330-8672-005 031-8703-052	MSS-100	0,4-0,75		5,2 ^{+0,2}

Spare indenter: 7011707 (121586-0038)

* available upon request

Visual Check

for machined contacts

Correct crimp

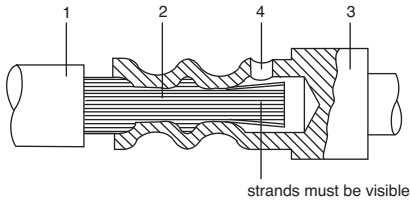

Correct crimp

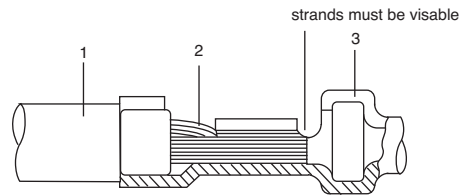

Incorrect crimp

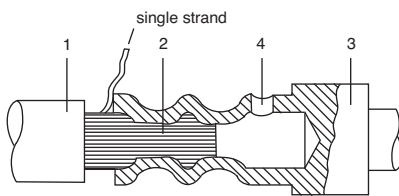

Incorrect crimp

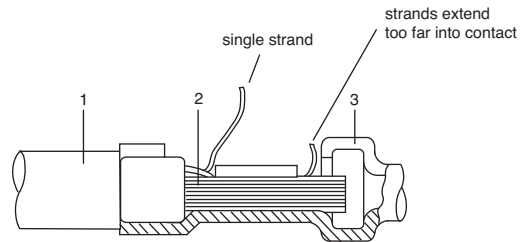

1 insulation 2 strands 3 contact 4 drill bore

Incorrect crimp

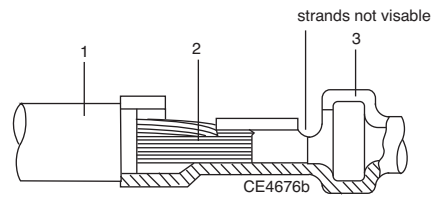

1 insulation 2 strands 3 contact

Tensile strength according to DIN 41611, section 3

Micro sections

Enlargement of micro section allows for final judgement of crimp quality. This test is recommended whenever new tools or new types of wire are used.

Contact Insertion Tools

for machined contacts

Support block for series production

Support block to install contacts in small and medium series. This support block consists of a basic body which can be equipped, according to individual requirements, with exchangeable insert for plugs and receptacles.

Please note: When required exchangeable inserts to be ordered separately.

Support block

for 2 to 10 way SURE-SEAL, SURE-SEAL with flange and for Mini SURE-SEAL 2 to 4 way.

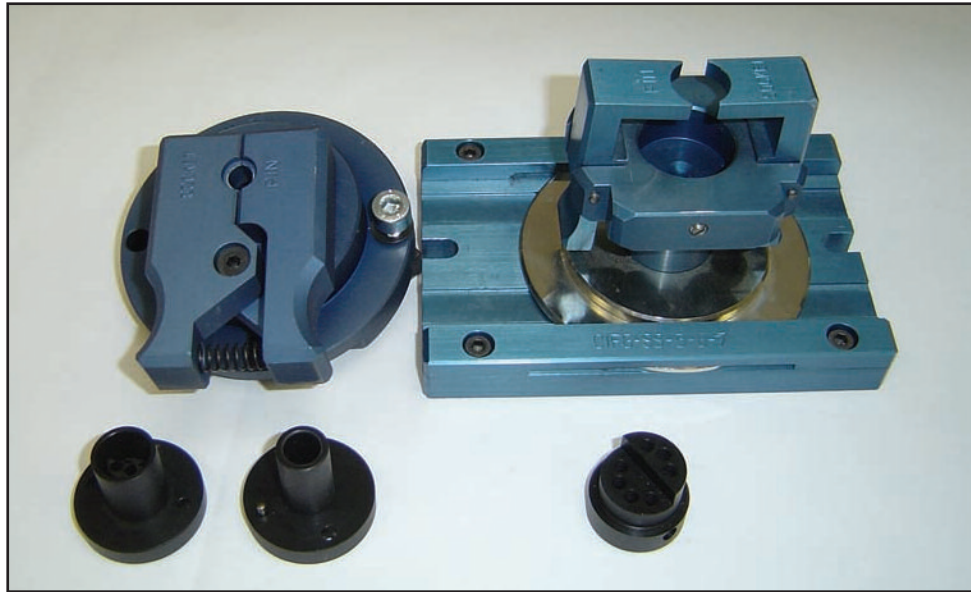

No. of contacts	Basic tool to use for SURE-SEAL Standard Plug/Receptacle	Order No.	Plug with Flange	Order No.	Mini SURE SEAL	Order No.
2	CIFG-SS-2	121086-3022	CIF-SSF-2	121086-3057	CIF-MSS-2	121086-3021
3	CIFG-SS-3	121086-3019	CIF-SSF-3	121086-3058	CIF-MSS-3	121086-3077
4	CIFG-SS-4	121086-3020	CIF-SSF-4	121086-3059	CIF-MSS-4	121086-3078
5/6/7	CIFG-SS-5-6-7	121586-0080	CIF-SSF-5-6-7	*		
8/9/10	CIFG-SS-8-9-10	121086-3056	CIF-SSF-8-9-10	*		

*available upon request

No. of contact	Exchangeable inserts to use for SURE-SEAL Standard Plug				
	Plug with flange	Receptacle	Mini SURE-SEAL Plug	Receptacle	
2	195-8508-000	195-8508-001	195-8508-013	195-8508-014	
3	195-8508-002	195-8508-003	195-8508-015	195-8508-016	
4	195-8508-004	195-8508-005	195-8508-017	195-8508-018	
5/6/7	195-8508-006	195-8508-007			
8/9/10	195-8508-008	195-8508-009			

Insertion Tool CIT



Hand insertion tool

Type of insulator	Description	Order No.	Outer insulation Ø
SS 2P + R to SS 10P + R SSF 8, 9, 10P	CITG-SS-1	121086-3025	1,8-2,8
SSF 2, 3, 4P	CIT-SSF-1	121086-3203	1,8-2,8
MSS 2, 3, 4P+R	CIT-MSS-1	121086-3023	1,4-1,8



Insertion tip

Type of insulator	Description	Order No.	Outer insulation Ø
SS 2P + R to SS 10P + R SSF 8, 9, 10P	CITG-SS-1-TIP	121586-0076	1,8-2,8
SSF 2, 3, 4P	CIT-SSF-1-TIP	121086-3202	1,8-2,8
MSS 2, 3, 4P+R	CIT-MSS-1-TIP	121586-0074	1,4-1,8

Handle

Order number: 204-8501-002



Contact holder tip

Type of insulator	Order No.	Outer insulation Ø
SS 2P + R to SS 10P + R SSF 8, 9, 10P	317-8666-005	1,8-2,8
SSF 2, 3, 4P	317-8666-007	1,8-2,8
MSS 2, 3, 4P+R	317-8666-002	1,4-1,8

Guiding pins have to be used for socket contacts. They are not necessary for Mini SURE-SEAL.

Order number: 317-8588-000

Approved lubricating fluid

Isopropyl alcohol

Cleaning solvent (e.g. HAKU 424, Chem. Fabrik Kluthe, Heidelberg, Germany)

Insertion Press CHPZ-240

A hand actuated insertion press can be used instead of a hand insertion tool. A manual assembly station consists of a press, a support block and a suitable insertion tip (refer to page 20-22). The CHPZ press, the required CIF... support block and the insertion tip must be ordered separately.

Basic press: CHPZ-240
 Support block: Refer to page 20
 Insertion tip: Refer to table
 Wire holder (accessory): 121086-3210

Version A: Single insertion tip, also used for the hand insertion tool
 B: Double insertion tip
 C: Single insertion tip; can be turned twice by 120°
 D: Single insertion tip; can be turned once by 180°

Parts subject to wear

Insertion tip

Type of contact	Order no.	Outer insulation Ø
SS-10	317-8666-007	1,8-2,8
SS-20	317-8666-007	1,8-2,8
MSS-100	317-8666-002	1,4-1,8



No. of contacts	Version A	Version B	Version C	Version D
2	<ul style="list-style-type: none"> • CIT-SSF-1-TIP ■ CIT-MSS-1-TIP 	<ul style="list-style-type: none"> • CIT-SSF-2-TIP ■ CIT-MSS-2-TIP 		
3	<ul style="list-style-type: none"> • CIT-SSF-1-TIP ■ CIT-MSS-1-TIP 		<ul style="list-style-type: none"> • CIT-SSF-3-TIP ■ CIT-MSS-3-TIP 	
4	<ul style="list-style-type: none"> • CIT-SSF-1-TIP ■ CIT-MSS-1-TIP 			<ul style="list-style-type: none"> • CIT-SSF-4-TIP ■ CIT-MSS-4-
TIP				
5	<ul style="list-style-type: none"> • CIT-SSF-1-TIP 			
6	<ul style="list-style-type: none"> • CIT-SSF-1-TIP 			
7	<ul style="list-style-type: none"> • CIT-SSF-1-TIP 			
8	<ul style="list-style-type: none"> • CIT-SSF-1-TIP 			
9	<ul style="list-style-type: none"> • CIT-SSF-1-TIP 			
10	<ul style="list-style-type: none"> • CIT-SSF-1-TIP 			

• = Standard SURE-SEAL with flange ■ = Mini SURE-SEAL (MSS)



Extraction Tools CET

Hand extraction tool

Type of insulator	Pin Contact Desc.	Pin Contact Order No.	Socket Contact Desc.	Socket Contact Order No.
SS 2 - 10P + R				
SSF 2, 3, 4P	CET-SS-P	121586-0121	CET-SS-S	121586-0122
SSF 8, 9, 10P				
MSS 2, 3, 4P+R	CET-MSS-P	121586-0123	CET-MSS-S	121586-0124

Spare tip

Type of insulator	Pin Contact Desc.	Pin Contact Order No.	Socket Contact Desc.	Socket Contact Order No.
SS 2 - 10P + R				
SSF 2, 3, 4P	CET-SS-P-TIP	121086-3207	CET-SS-S-TIP	121086-3189
SSF 8, 9, 10P				
MSS 2, 3, 4P+R	CET-MSS-P-TIP	121086-3191	CET-MSS-S-TIP	121086-3192



Handle
Order number: 204-8501-002

Auxiliary Tools CIEF and CIET

Auxiliary tools for repairs

Device for holding connectors during insertion and extraction of crimped contacts.

No. of contacts	Type of insulator	Description	Order no.
2, 3, 4	SS...P + R SSF...P	CIEF-SS-2-3-4	121086-3097
5, 6, 7	SS...P + R	CIEF-SS-5-6-7	121086-3098
8, 9, 10	SS...P + R SSF...P	CIEF-SS-8-9-10	121086-3179
2, 3, 4	MSS...P + R	CIEF-MSS-2-3-4	121086-3099

Guiding pins can be extracted by using a socket contact which is slightly tilted.

Kit for field repair work and prototype

Kit	No. of contacts	Type of insulator	Description	Order no.
1	2, 3, 4 2, 3, 4	SS...P + R SSF...P	CIET-SS-2-3-4-KIT-10	121086-3226
2	5, 6, 7	SS...P + R	CIET-SS-5-6-7-KIT-10	*
3*	8, 9, 10 8, 9, 10	SS...P + R SSF...P	CIET-SS-8-9-10-KIT-10	121086-3228
4	2, 3, 4 2, 3, 4	SS...P + R SSF...P	CIET-SS-2-3-4-KIT-20	121086-3229
5	5, 6, 7	SS...P + R	CIET-SS-5-6-7-KIT-20	*
6*	8, 9, 10 8, 9, 10	SS...P + R SSF...P	CIET-SS-8-9-10-KIT-20	*
7	2, 3, 4	SS...P + R	CIET-MSS-2-3-4-KIT	121086-3232

* upon request

Dimensions shown in mm
Specifications and dimensions subject to change

www.ittcannon.com



Contents

- 1 Operating instruction
- 1 CIEF Insertion and extraction holder
- 1 CIT Insertion tool
- 1 CET Extraction tool (socket contacts)
- 1 CET Extraction tool (pin contacts)
- 1 CCT Crimp tool

Lubricating fluid: Isopropyl alcohol
10 Guiding pins (not included for MSS)



Semi-Automatic Assembly Machine CBITA

for 2 to 10 way SURE-SEAL connectors.

Technical Data

Air pressure	min. 6 bar
Weight	approx. 60 kg
Power supply	220 V/50Hz

No. of contacts	Assembly machine
2	CBITA-SS-2
3	CBITA-SS-3
4	CBITA-SS-4
5	CBITA-SS-5
6	CBITA-SS-6
7	CBITA-SS-7
8	CBITA-SS-8
9	CBITA-SS-9
10	CBITA-SS-10

Parts subject to wear:

Guiding pin-Sensor release	121586-5229
Guiding pin-Foot pedal release	970-8606-022
Widening tip	252-7015-003

Wiring Instructions

Note: Insert accessories (e. g. Boot) prior to assembly.

Stripping lengths

For jacketed cables the following stripping lengths have to be adhered to.

No. of contacts	min. stripping lengths mm
2, 3, 4	40
5, 6, 7	45
8, 9, 10	50

Insertion contacts

SURE-SEAL connectors have a one-piece connector body made of rubber. Contacts are inserted from the rear side. They may only be inserted with the approved tools (refer to page 19-23).

Plug or receptacle must be sprayed with lubricating fluid before contact insertion.

Approved lubricating fluid

Manual insertion

Isopropyl alcohol
 Cleaning solvent HAKU 1025-975 or HAKU 1025-800, Chem. Werke Kluthe Gottlieb-Daimler Straße 12, 69115 Heidelberg

Semi-automatic insertion

CBITG...and CBITS...Hellerine (HellermanTyton, Grosseer Moorweg 45, 25436 Tomesch) for sprayer.

With hand insertion tools

Fasten supports (table, vice etc.)

An inclined position is recommended for easier assembly.

- Dip insulator in lubricating fluid and shake off excess fluid.
- Open fixing clip and place connector body into support block (refer to page 20).
- Insert cable resp. single wires into accessories (e. g. boot).
- Pay attention to correct sequence and position
- Install guiding pin 317-8588-000 (does not apply to Mini SURE-SEAL) in socket contact.

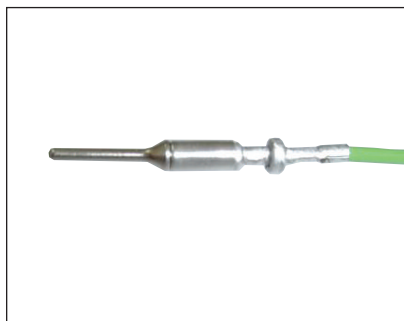

- Place contact in hand insertion tool. The contact shoulder has to touch the front side of the contact tip.

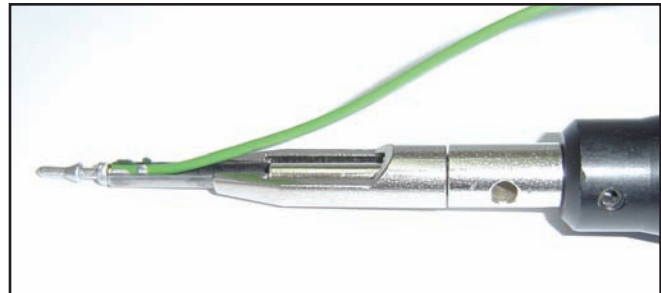

- Insert contact into the connector until it snaps in by applying constant pressure. Note: Make sure that the contact and tool are inserted parallel to the insulator axis. Do not tilt!

Note: Socket or pin contacts have to be inserted into the correct contact cavity.

- Remove guiding pins from the socket contacts!
- Mount accessories.
- Remove the terminated connector from support after insertion of all contacts and check correct fit and position of the contacts in the insulator.

Usage of jacketed cable with boot

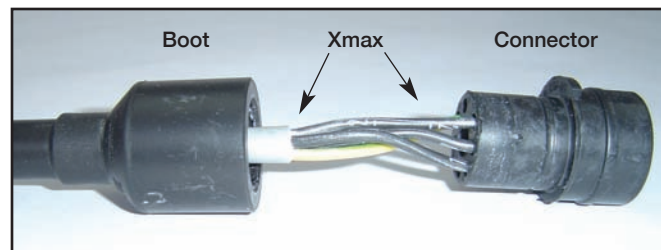

No. of contacts	X max.
2, 3, 4	22
5, 6, 7	26

Dimensions shown in mm
 Specifications and dimensions subject to change

www.ittcannon.com

Wiring Instructions

With CHPZ-240 hand lever insertion press

Mount correct support block and insertion tip to CHPZ-240 insertion press (refer to page 22).

- Dip connector body into lubricating fluid and shake off excess fluid. Open fixing clip and place connector body in support block (refer to page 20).
- Insert wire into accessories. Pay attention to correct sequence and position (refer to illustration page 25).
- Insert guiding pins 317-8588-000 (only for Standard SURE-SEAL) into socket contacts (refer to illustration page 25).
- Place contact into insertion tip. Contact shoulder has to be flush with lower edge of the contact tip.

- Adjust height of hand lever press: For first insertion loosen stop at the upper end of the press. Move down lever slowly and steadily and adjust stop until contact is in the correct position (refer to page 21). Tighten stop. This adjustment may be used for both socket and pin contacts. After this adjustment the lever is simply pressed until stop is reached. Remove terminated connector from support after all contacts are inserted.
- Check fit and position of contacts in insulator.
- Remove guiding pins from socket contacts.
- Assemble accessories.

For Assembly Machines CBITG and CBITS
refer to separate operating instructions

Standard SURE-SEAL

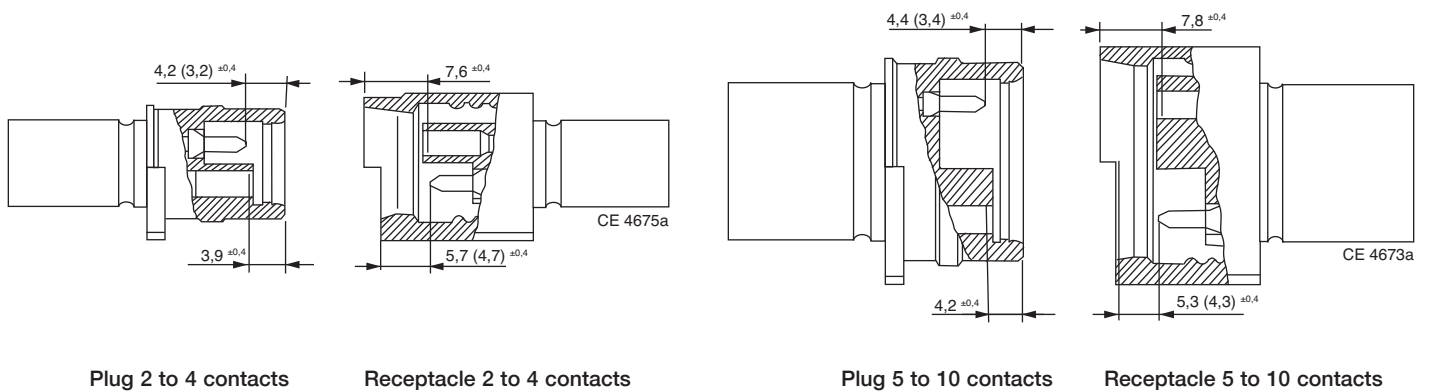

Different dimensions for machined contacts are given in paranthesis.

Mini SURE-SEAL

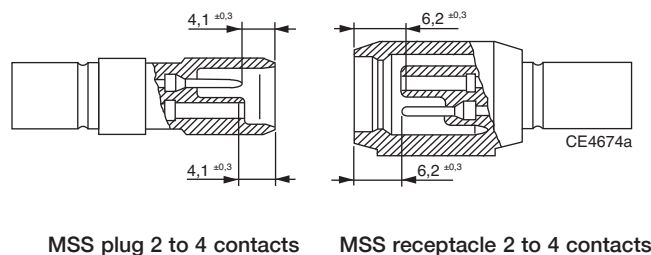

Part Number Index

Part Number	Page	Part Number	Page
026-0450-000	16	121086-3232	25
026-0451-000	16	121347-0010	14
029-0262-000	16	121347-0020	14
029-0263-000	16	121348-0010	14
029-8514-000	16	121348-0020	14
029-8514-001	16	121347-0100	9
029-8514-004	16	121348-0100	9
031-8703-000	14, 17	121586-0038	20
031-8703-001	14, 17	121586-0074	23
031-8703-050	14, 19, 20	121586-0076	23
031-8703-051	14, 19, 20	121586-0080	22
031-8703-052	9, 19, 20	121586-0085	17
031-8703-054	19, 20	121586-0121	25
031-8703-055	19, 20	121586-0122	25
031-8703-100	9, 17	121586-0123	25
066-8516-000	14	121586-0124	25
066-8516-002	14	121586-5067	19
120090-0114	19	121586-5068	19
120-8551-000	13	121568-5069	19
120-8551-001	13	121586-5214	18
120-8551-002	13	121586-5215	18
120-8551-005	13	121586-5216	18
120-8551-006	13	121586-5225	18
120-8551-007	13	121586-5229	26
120-8551-100	8	195-8508-000	22
120-8551-101	8	195-8508-001	22
120-8551-102	8	195-8508-002	22
120-8551-308	13	195-8508-003	22
120-8551-309	13	195-8508-004	22
120-8551-310	13	195-8508-005	22
120-8552-000	11	195-8508-006	22
120-8552-001	11	195-8508-007	22
120-8552-002	11	195-8508-008	22
120-8552-005	11	195-8508-009	22
120-8552-006	11	195-8508-013	22
120-8552-007	11	195-8508-014	22
120-8552-100	8	195-8508-015	22
120-8552-101	8	195-8508-016	22
120-8552-102	8	195-8508-017	22
120-8552-200	12	195-8508-018	22
120-8552-201	12	204-8501-002	23, 25
120-8552-202	12	225-0093-000	14, 15
120-8552-305	12	225-1012-000	9, 15
120-8552-306	12	252-7015-003	26
120-8552-307	12	317-1397-000	15
120-8552-308	11	317-1398-000	15
120-8552-309	11	317-1399-000	15
120-8552-310	11	317-8588-000	23, 27, 28
121086-3019	22	317-8657-000	15
121086-3020	22	317-8657-002	15
121086-3021	22	317-8666-002	23, 24
121086-3022	22	317-8666-005	23
121086-3023	23	317-8666-007	23, 24
121086-3025	23	330-8672-000	14, 17
121086-3056	22	330-8672-001	14, 17
121086-3057	22	330-8672-002	14, 19, 20
121086-3058	22	330-8672-003	14, 19, 20
121086-3059	22	330-8672-005	9, 19, 20
121086-3077	22	330-8672-008	19, 20
121086-3078	22	330-8672-009	19, 20
121086-3097	25	330-8672-100	9, 17
121086-3098	25	351-1633-000	15
121086-3099	25	351-1634-000	15
121086-3179	25	351-1640-000	15
121086-3189	25	351-1641-000	15
121086-3191	25	970-8606-022	26
121086-3192	25	995-0001-585	19
121086-3202	23	WWZ-EVS-MSS	18
121086-3203	23	WWZ-EVS-SS-10	18
121086-3207	25	WWZ-EVS-SS-20	18
121086-3210	24		
121086-3225	17		
121086-3226	25		
121086-3228	25		
121086-3229	25		

Dimensions shown in mm
 Specifications and dimensions subject to change

Product Safety Information

THIS NOTE MUST BE READ IN CONJUNCTION WITH THE PRODUCT DATA SHEET/CATALOG. FAILURE TO OBSERVE THE ADVICE IN THIS INFORMATION SHEET AND THE OPERATING CONDITIONS SPECIFIED IN THE PRODUCT DATA SHEET/ CATALOG COULD RESULT IN HAZARDOUS SITUATIONS.

1. MATERIAL CONTENT AND PHYSICAL FORM

Electrical connectors do not usually contain hazardous materials. They contain conducting and non-conducting materials and can be divided into two groups.

a) Printed circuit types and low cost audio types which employ all plastic insulators and casings.

b) Rugged, Fire Barrier and High Reliability types with metal casings and either natural rubber, synthetic rubber, plastic or glass insulating materials. Contact materials vary with type of connector and also application and are usually manufactured from either: Copper, copper alloys, nickel, alumel, chromel or steel. In special applications, other alloys may be specified.

2. FIRE CHARACTERISTICS AND ELECTRIC SHOCK HAZARD

There is no fire hazard when the connector is correctly wired and used within the specified parameters. Incorrect wiring or assembly of the connector or careless use of metal tools or conductive fluids, or transit damage to any of the component parts may cause electric shock or burns. Live circuits must not be broken by separating mated connectors as this may cause arcing, ionization and burning. Heat dissipation is greater at maximum resistance in a circuit. Hot spots may occur when resistance is raised locally by damage, e.g. cracked or deformed contacts, broken strands of wire. Local overheating may also result from the use of the incorrect application tools or from poor quality soldering or slack screw terminals. Overheating may occur if the ratings in the product Data Sheet/Catalog are exceeded and can cause breakdown of insulation and hence electric shock. If heating is allowed to continue it intensifies by further increasing the local resistance through loss of temper of spring contacts, formation of oxide film on contacts and wires and leakage currents through carbonization of insulation and tracking paths. Fire can then result in the presence of combustible materials and this may release noxious fumes.

Overheating may not be visually apparent. Burns may result from touching overheated components.

3. HANDLING

Care must be taken to avoid damage to any component parts of electrical connectors during installation and use. Although there are normally no sharp edges, care must be taken when handling certain components to avoid injury to fingers. Electrical connectors may be damaged in transit to the customers, and damage may result in creation of hazards. Products should therefore be examined prior to installation/use and rejected if found to be damaged.

4. DISPOSAL

Incineration of certain materials may release noxious or even toxic fumes.

5. APPLICATION

Connectors with exposed contacts should not be selected for use on the current supply side of an electrical circuit, because an electric shock could result from touching exposed contacts on an unmated connector. Voltages in excess of 30 V ac or 42.5 V dc are potentially hazardous and care should be taken to ensure that such voltages cannot be transmitted in any way to exposed metal parts of the connector body. The connector and wiring should be checked, before making live, to have no damage to metal parts or insulators, no solder blobs, loose strands, conducting lubricants, swarf, or any other undesired conducting particles. Circuit resistance and continuity check should be made to make certain that there are no high resistance joints or spurious conducting paths. Always use the correct application tools as specified in the Data Sheet/Catalog. Do not permit untrained personnel to wire, assemble or tamper with connectors. For operation voltage please see appropriate national regulations.

IMPORTANT GENERAL INFORMATION

(i) Air and creepage paths/Operating voltage. The admissible operating voltages depend on the individual applications and the valid national and other applicable safety regulations.

For this reason the air and creepage path data are only reference values. Observe reduction of air and creepage paths due to PC board and/or harnessing.

(ii) Temperature

All information given are temperature lim-

its. The operation temperature depends on the individual application.

(iii) Other important information

Cannon continuously endeavors to improve their products. Therefore, Cannon products may deviate from the description, technical data and shape as shown in this catalog and data sheets.

“Engineered for life” is a registered trademark of ITT Industries, ©2006. All other trademarks or registered trademarks are property of their respective owners. All data subject to change without notice.

Product Warranty

ITT Cannon, a Division of ITT Industries, Inc. manufactures the highest quality products available in the marketplace; however these products are intended to be used in accordance with the specifications in this publication. Any use or application that deviates from the stated operating specifications is not recommended and may be unsafe. No information and data contained in this publication shall be construed to create any liability on the part of Cannon. Any new issue of this publication shall automatically invalidate and supersede any and all previous issues. A limited warranty applies to Cannon products. Except for obligations assumed by Cannon under this warranty, Cannon shall not be liable for any loss, damage, cost of repairs, incidental or consequential damages of any kind, whether or not based on express or implied warranty, contract, negligence or strict liability arising in connection with the design, manufacture, sale, use or repair of the products. Product availability, prices and delivery dates are exclusively subject to our respective order confirmation form; the same applies to orders based on development samples delivered. This publication is not to be construed as an offer. It is intended merely as an invitation to make an offer. By this publication, Cannon does not assume responsibility or any liability for any patent infringements or other rights of third parties which may result from its use. Reprinting this publication is generally permitted, indicating the source. However, Cannon's prior consent must be obtained in all cases.

Circular/Filter/Hermetic/Fiber Optic Connectors

As a world leader in circular, filter, and hermetic connectors, ITT can leverage its design and manufacturing expertise to fit virtually any application. Our expertise includes fast positive mating for a wide range of military applications, as well as numerous sizes and contact configurations for various harsh environments. Our wide variety of fiber optic products include hybrid contacts, multi-channel, rack and panel, and hi-rel assemblies, including MIL and ARINC standard solutions. ITT can meet numerous specs, including NATO and MIL standards.

www.ittcannon.com/circulars • www.ittcannon.com/filter • www.ittcannon.com/hermetics • www.ittcannon.com/fiberoptics



D-Subminiature Connectors

Cannon invented D-sub connectors in 1952. Our family of D-Subs now includes combinations of signal, power and RF, as well as severe service sealed connectors. Cannon D-Subs are available with an extensive line of backshells and accessories and are one of the most economical shielded connector solutions available. ITT D-Sub connectors are qualified to the MIL-DTL-24308 specification.

www.ittcannon.com/dsubs



Microminiature Connectors

Developed first by Cannon in the 1960's, Interconnect Solutions microminiature connectors offer high performance and reliability with exceptional versatility. Available in rectangular, circular, and strip configurations for countless applications, many of our connectors meet or exceed applicable requirements of the MIL-DTL-83513 specification.

www.ittcannon.com/micro



Rack and Panel Connectors

Initially pioneered by Cannon during the 1930s, Interconnect Solutions is the world leader in rack and panel connectors, offering unmatched variety of shell configurations and insert arrangements, materials, plating, and contact options. Many of our standard and custom designs meet the stringent requirements of ARINC 600, ARINC 404 (MIL-C-81659), and MIL-DTL-83733 standards.

www.ittcannon.com/rackandpanel



RF Connectors

ITT Interconnect Solutions has been providing interconnect products to the Microwave and RF industry since 1963 (formerly The Sealelectro Corporation). The RF 50 & 75 Ohm product lines cover UHF band through Ku band requirements. These connectors and cable assemblies are available with a thread type, snap type, bayonet type or slide on coupling method. The frequencies range from DC to 18+ GHz.

www.ittcannon.com/RF50 • www.ittcannon.com/RF75



Transportation

The ITT ICS interconnect range includes sealed circular and rectangular connectors in metal or plastic shells. These configurations include board to cable or cable to cable/ bulkhead applications. Both signal and power contacts can be combined in various layouts. All product lines within the Transportation segment offer very low contact resistance providing maximum signal integrity.

www.ittcannon.com/transportation



ITT Interconnect Solutions is an international manufacturer and supplier of connectors including circular, rectangular, fiber optic, RF, power and high voltage, audio, PCMCIA, Compact Flash Card, enclosures, cable assemblies, and application specific custom solutions. The Interconnect Solutions portfolio includes the brands Cannon, VEAM, and BIW. As a worldwide leader in connector technology for nearly a century, ITT offers one of the broadest product offerings, six sigma manufacturing capability, Value Based Product Development with exceptional engineering capability, and an extensive sales, distribution, and customer support network.



ITT Interconnect Solutions
Cannon, VEAM, BIW

Visit our website at
www.ittcannon.com



- Global Design & Manufacturing**
- Customer Support**

North America

- MEXICO - Cannon, VEAM**
Av. Libre Comercio s/n-
entre Calzada Industrial
Nuevo Nogales y Calzada del Raquet Club,
Parque Industrial Nuevo Nogales
84093 Nogales, Sonora
phone: +52.631.3110050
fax: +52.631.3110060
- USA - Cannon**
666 East Dyer Road
Santa Ana, CA 92705
toll free: +1.800.854.3028
phone: +1.714.557.4700
fax: +1.714.628.2142
- USA - BIW**
500 Tesconi Circle
Santa Rosa, CA 95401
phone: +1.707.523.2300
fax: +1.707.523.3567
- USA - VEAM**
100 New Wood Road
Watertown, CT 06795
phone: +1.860.274.9681
fax: +1.860.274.4963

Europe & Middle East

- FRANCE - Cannon, VEAM**
15, Boulevard Robert Thiboust
77700 Serris, France
phone: +33.1.60.04.93.93
fax: +33.1.60.04.93.90
- GERMANY - Cannon, VEAM**
ITT Cannon GmbH
Cannonstrasse 1
71384 Weinstadt
phone: +49.7151.699.0
fax: +49.7151.699.217
- ITALY - Cannon, VEAM**
Corso Europa 41/43
20020 Lainate (MI), Italy
phone: +39.02938721
fax: +39.0293872300
- LEBANON - BIW**
P.O. Box 199
Jounieh
Lebanon
phone: +961.9.911.560
fax: +961.9.912.126
- UK - Cannon, VEAM**
Jays Close, Viabes Estate
Basingstoke
RG22 4BA
phone: +44.1256.311200
fax: +44.1256.323356

Asia

- CHINA - Cannon, VEAM**
Tuopandun Industrial Area,
Jinda Cheng, Xiner Village, Shajing Town,
Boan District, Shenzhen City,
Guangdong Province, 518125
phone: +86.755.2726.7238
fax: +86.755.2726.7515
- HONG KONG - Cannon, VEAM**
Units 2405-6, 24/F, ING Tower
308 Des Voeux Road Central
Hong Kong
phone: +852.2732.2720
fax: +852.2732.2919
- INDIA - Cannon, VEAM**
ITT Corporation India Pvt Ltd
Money Chamber, Unit No. 202
#6, KH Road
Bangalore 560027
phone: +91 22 67843000
fax: +91 22 26783033
- JAPAN - Cannon, VEAM**
5-11-3, Hibarigaoka, Zama-shi
Kanagawa 252-0003
phone: +81.462.57.2010
fax: +81.462.57.1680
- SINGAPORE - Cannon, VEAM**
10 Jalan Kilang #06-01
159410 Singapore
phone: +65.62763693 ext 232
fax: +65.62763685



ENGINEERED FOR LIFE

© 2012 ITT Corporation. The "ITT Engineered Blocks" symbol, "Engineered for life", "ITT", "Cannon", "Veam" and "BIW" are registered trademarks of ITT Corporation. Specification and other data are based on information available at the time of printing, and are subject to change without notice. Photo Credits vehicles: Shutterstock.com