

4 PIN PLUG

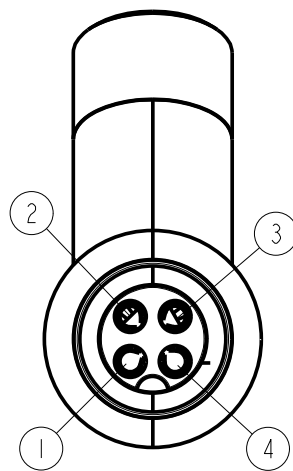

(FACE VIEW)

6 PIN MINIDIN

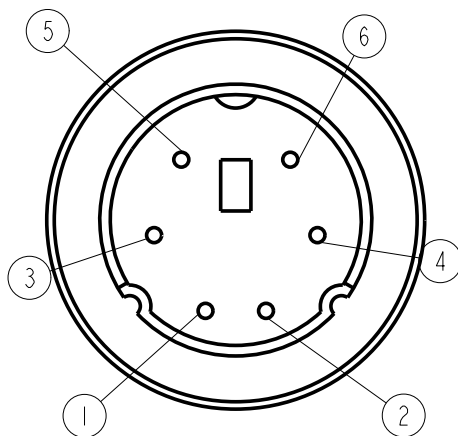

(FACE VIEW)

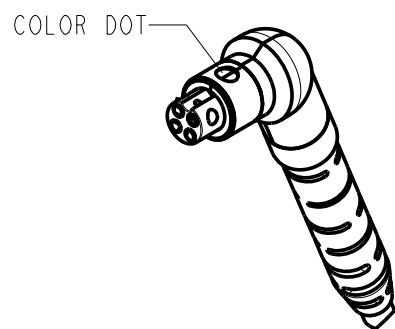
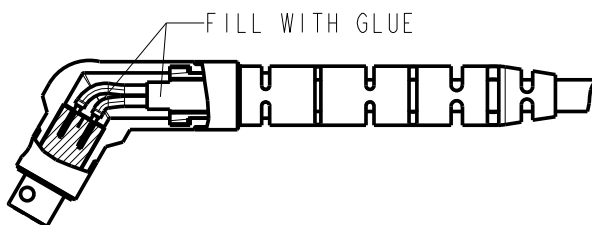

LOGO PRINTING DETAIL

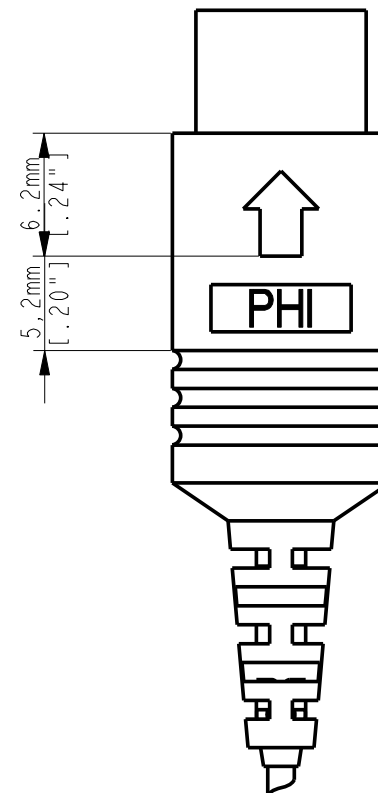

CHARACTER COLOR: WHITE  
CHARACTER SIZE: 2X5mm

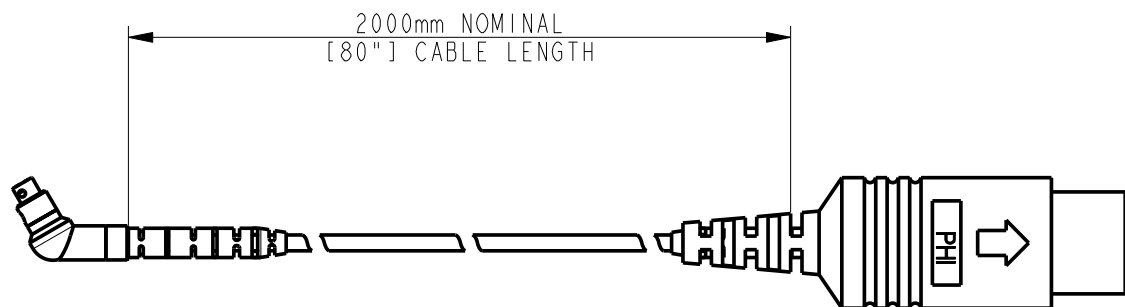
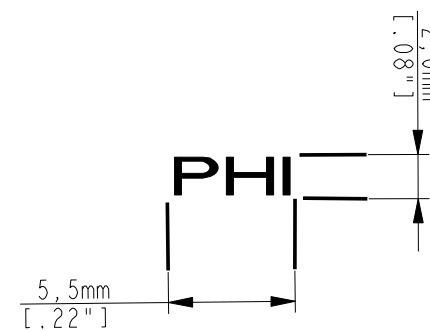

SCALE 3:2

**RED CONTROLLED**

REFERENCE NUMBER: 009P-4-4-00-36-07-20-1-1-XX

LEAD CONFIGURATION		
PLUG	MINIDIN	
① SHIELD	②	MINIDIN CONFIG
② WHITE	①	
③ BLACK	③	
④ RED	④	

SCALE: 3:2		MATERIAL:	
FUNDAMENTAL TOLERANCE: ± 0.03 [0.001]		HEAT TREATMENT:	
ANGLE TOLERANCE: ± 1°		FINISH:	
MISMATCH TOLERANCE: ± 0.03 [0.001]		TITLE: <b>PLUG WITH MINIDIN MODEL 009P</b>	
DESIGNED: 3-6-08	DATE	NAME	RELEASED LEVEL: Active
CHECKED: 3-10-08		SJ	
RELEASED: 3-10-08		GJP	
PROPRIETARY NOTE: THIS DOCUMENT CONTAINS INFORMATION WHICH IS THE PROPRIETARY PROPERTY OF KNOWLES ELECTRONICS, LLC. OR ITS AFFILIATED ENTITIES. IT IS ISSUED IN STRICT CONFIDENCE AND SHALL NOT BE REPRODUCED, COPIED, USED, OR DISCLOSED TO ANY THIRD PARTY PARTIALLY OR WHOLLY IN ANY MANNER WITHOUT PRIOR WRITTEN PERMISSION OF, AND MUST BE RETURNED UPON REQUEST BY, KNOWLES ELECTRONICS, LLC.		DRAWING NUMBER: <b>009P-253888</b>	
		REVISION: <b>A</b> SHEETS: 1 of 1	