

THIS DOCUMENT IS THE PROPERTY OF
KEYSTONE ELECTRONICS CORP. AND
SHALL NOT BE REPRODUCED, DISTRIBUTED
OR USED AS A BASIS FOR MANUFACTURE
WITHOUT PRIOR WRITTEN PERMISSION
FROM KEYSTONE ELECTRONICS CORP.

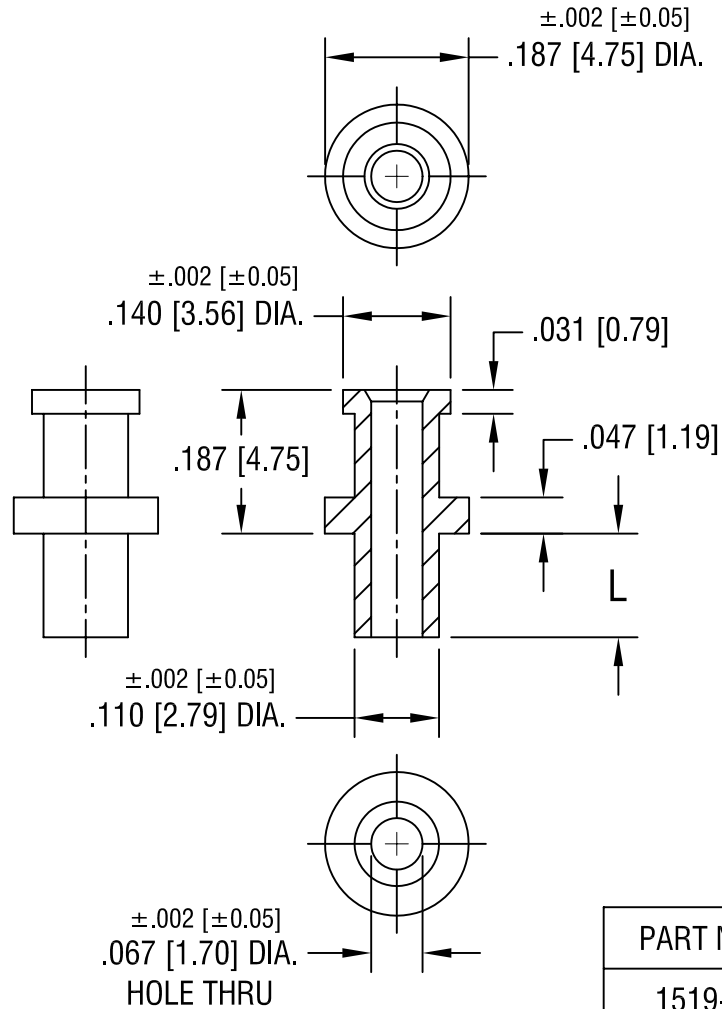

PART NO.	'L' DIM.
1519-1	.078 [1.98]
1519-2	.109 [2.77]
1519-3	.140 [3.56]
1519-4	.171 [4.34]

KEYSTONE ELECTRONICS CORP.

ASTORIA, N.Y. 11105-2017

PART NAME

TERMINAL

MATERIAL

BRASS

FINISH

TIN PLATE

DRN BY

BOONE

DATE

6.10.02

APPD

LN

SCALE

4X

TOLERANCES

INCH [MM]

DECIMAL $\pm .005$ [± 0.15]

ANGULAR $\pm 1^\circ$
UNLESS OTHERWISE SPECIFIED

CODE

C/M

DWG NO.

1519-

DATE

DESCRIPTION

REV.