



Product Description

RFMD's SGA-1163(Z) is a SiGe HBT MMIC amplifier that offers excellent isolation and flat gain response for applications to 6GHz. A 2-stage design provides high isolation up to 40dB at 2GHz and is fabricated using the latest SiGe HBT 50GHz FT process, featuring one-micron emitters with $V_{CEO} > 7V$. This unconditionally stable amplifier has less than 1dB gain drift over 125 °C operating range (-40 °C to +85 °C) and is ideal for use as a buffer amplifier in oscillator applications covering cellular, ISM, and narrowband PCS bands.

Optimum Technology Matching® Applied

- GaAs HBT
- GaAs MESFET
- InGaP HBT
- SiGe BiCMOS
- Si BiCMOS
- SiGe HBT
- GaAs pHEMT
- Si CMOS
- Si BJT
- GaN HEMT
- RF MEMS

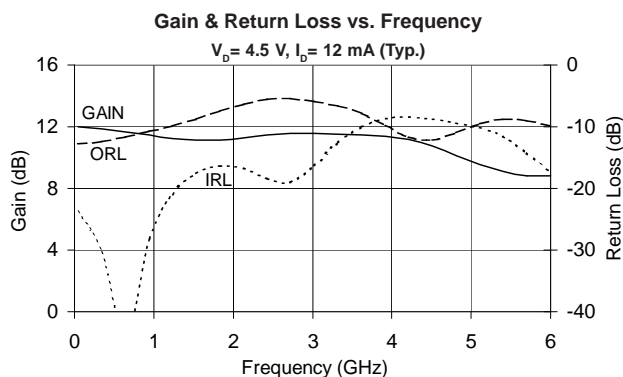

Features

- DC to 6000MHz Operation
- Excellent Isolation, >50dB at 900MHz
- Single Supply Voltage
- Unconditionally Stable
- Cascadable 50Ω

Applications

- Buffer Amplifier for Oscillator Applications
- Cellular, PCS, GSM, UMTS
- Wireless Data, Satellite

Parameter	Specification			Unit	Condition
	Min.	Typ.	Max.		
Small Signal Gain	11.0	12.5	14.0	dB	850MHz
	10.0	11.5	13.0	dB	1950MHz
		11.4		dB	2400MHz
Output Power at 1dB Compression	-4.0	-3.3		dBm	850MHz
		-2.5		dBm	1950MHz
Output Third Order Intercept Point		7.9		dBm	850MHz
	4.3	6.3		dBm	1950MHz
Bandwidth		6000		MHz	
Input Return Loss		16.4		dB	1950MHz
Output Return Loss		7.0		dB	1950MHz
Noise Figure		3.4		dB	1950MHz
Device Operating Voltage	4.2	4.5	4.8	V	
Device Operating Current	10	12	14	mA	
Thermal Resistance		255		°C/W	junction - lead

Test Conditions: $V_S = 8V, I_D = 12mA$ Typ., $T_L = 25°C$. OIP₃ Tone Spacing = 1MHz, P_{OUT} per tone = -20dBm, R_{BIAS} = 300Ω, Z_S = Z_L = 50Ω

Absolute Maximum Ratings

Parameter	Rating	Unit
Device Current (I_D)	24	mA
Device Voltage (V_D)	6	V
RF Input Power	+12	dBm
Junction Temp (T_J)	+150	°C
Operating Temp Range (T_L)	-40 to +85	°C
Storage Temp	+150	°C
ESD Rating - Human Body Model (HBM)	Class 0	



Caution! ESD sensitive device.

Exceeding any one or a combination of the Absolute Maximum Rating conditions may cause permanent damage to the device. Extended application of Absolute Maximum Rating conditions to the device may reduce device reliability. Specified typical performance or functional operation of the device under Absolute Maximum Rating conditions is not implied.

RoHS status based on EU Directive 2002/95/EC (at time of this document revision).

The information in this publication is believed to be accurate and reliable. However, no responsibility is assumed by RF Micro Devices, Inc. ("RFMD") for its use, nor for any infringement of patents, or other rights of third parties, resulting from its use. No license is granted by implication or otherwise under any patent or patent rights of RFMD. RFMD reserves the right to change component circuitry, recommended application circuitry and specifications at any time without prior notice.

Operation of this device beyond any one of these limits may cause permanent damage. For reliable continuous operation, the device voltage and current must not exceed the maximum operating values specified in the table on page one.

Bias Conditions should also satisfy the following expression:

$$I_D V_D < (T_J - T_L) / R_{TH, j-I}$$

Typical Performance at Key Operating Frequencies

Parameter	Unit	100 MHz	500 MHz	850 MHz	1950 MHz	2400 MHz	3500 MHz
Small Signal Gain, G	dB	12.0	11.8	12.5	11.5	11.4	11.5
Output Third Order Intercept Point, OIP ₃	dBm		8.7	7.9	6.3	5.7	
Output Power at 1dB Compression, P _{1dB}	dBm		-3.8	-3.3	-4.6	-4.4	
Input Return Loss, IRL	dB	25.2	33.9	32.6	16.4	18.3	10.9
Output Return Loss, ORL	dB	12.7	12.0	11.0	7.0	5.6	7.3
Reverse Isolation, S ₁₂	dB	47.8	57.0	50.4	33.5	30.8	28.3
Noise Figure, NF	dB		3.1	3.1	3.4	3.4	

Test Conditions: $V_S = 8V$ $I_D = 12mA$ Typ. OIP₃ Tone Spacing = 1MHz, P_{OUT} per tone = -20dBm $R_{BIAS} = 300\Omega$
 $T_L = 25^\circ C$ $Z_S = Z_L = 50\Omega$

NOT FOR NEW DESIGNS

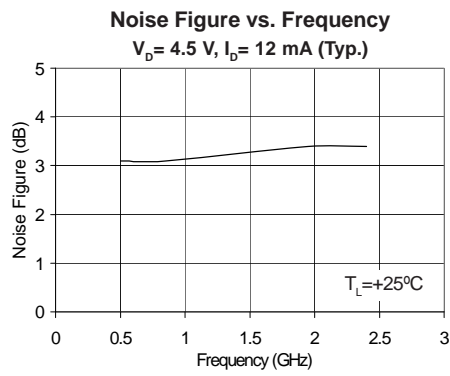
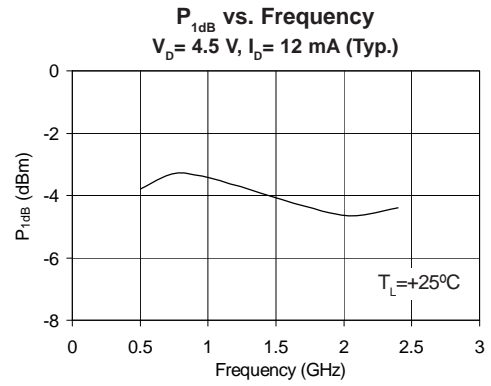
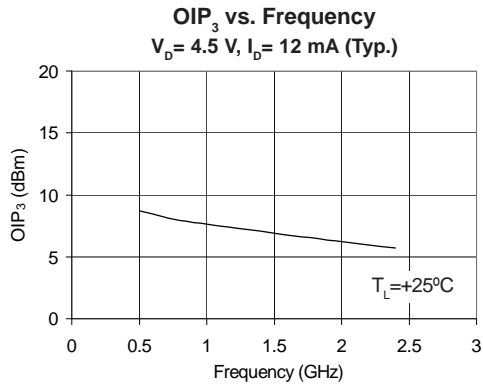

NOT FOR NE

Typical RF Performance Over Temperature (Bias: $V_D = 4.5$ V, $I_D = 12$ mA (Typ.))

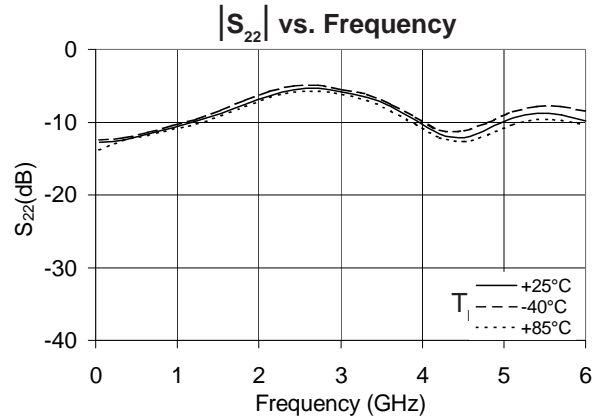
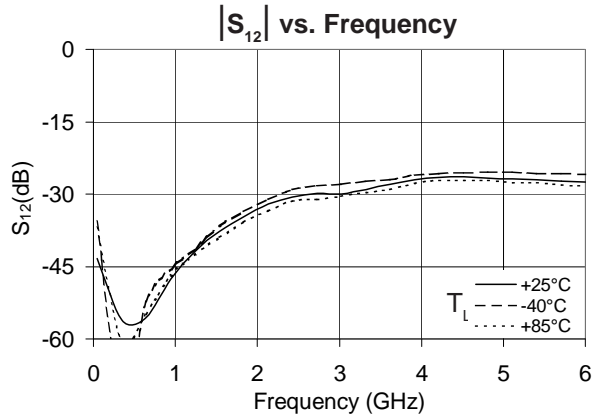
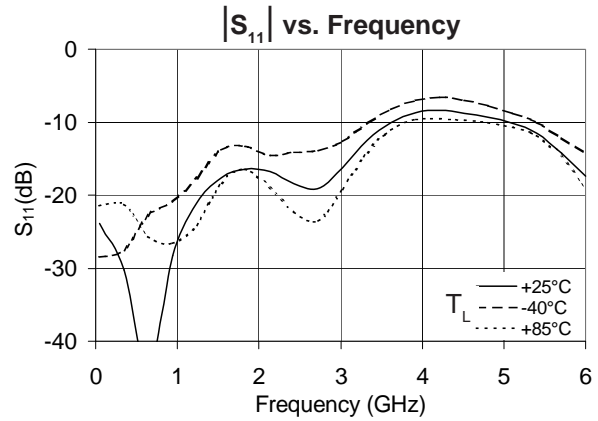
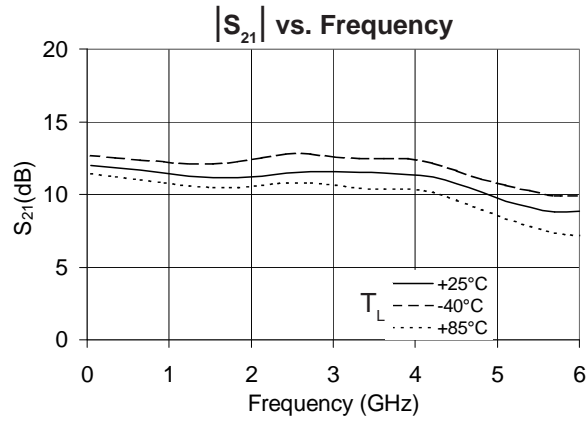

NOT FOR

Pin	Function	Description
3	RF IN	RF input pin. This pin requires the use of an external DC-blocking capacitor chosen for the frequency of operation.
4	VCC	Voltage supply connection. Use bypass capacitors as indicated by the basic application circuit.
1, 2, 5	GND	Connection to ground. For optimum RF performance, use via holes as close to ground leads as possible to reduce lead inductance.
6	RF OUT	RF output pin. DC voltage is present on this pin, therefore a DC-blocking capacitor is necessary for proper operation.

Suggested Pad Layout

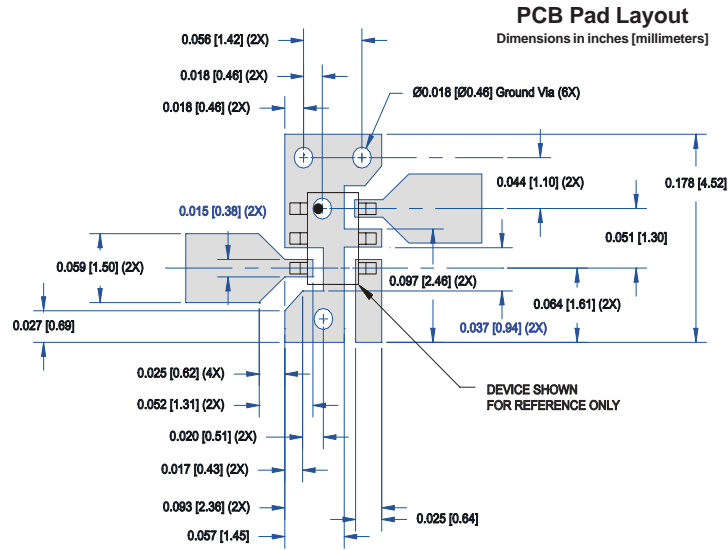

Package Drawing

Dimensions in inches (millimeters)
Refer to drawing posted at www.rfmd.com for tolerances.

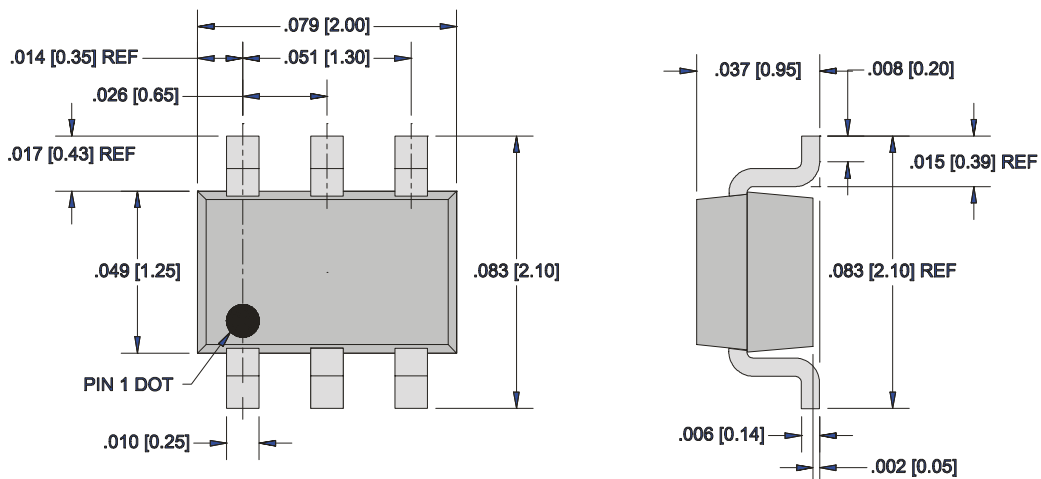

Application Schematic

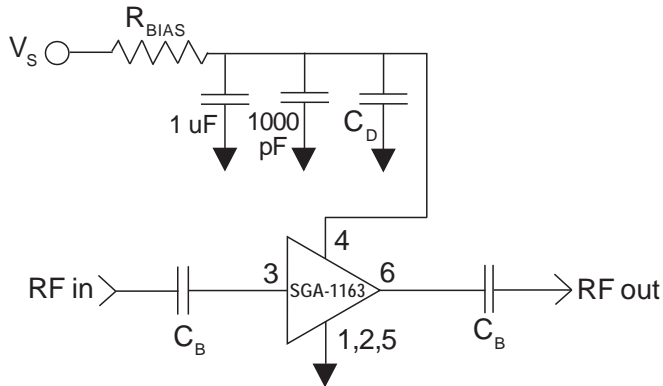

Reference Designator	Frequency (Mhz)				
	500	850	1950	2400	3500
C _B	220 pF	100 pF	68 pF	56 pF	39 pF
C _D	100 pF	68 pF	22 pF	22 pF	15 pF

Recommended Bias Resistor Values for I _D =12mA					
$R_{BIAS} = (V_S - V_D) / I_D$					
Supply Voltage (V _S)	6 V	8 V	9 V	12 V	
R _{BIAS}	130 Ω	300 Ω	390 Ω	620 Ω	

Note: R_{BIAS} provides DC bias stability over temperature.

Evaluation Board Layout

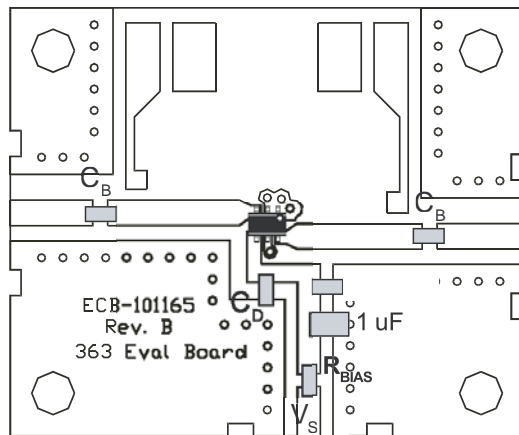

1. Use a large ground pad area near device pins 1, 2, 4, and 5 with many plated through-holes as shown.
3. We recommend 1 or 2 ounce copper. Measurements for this data sheet were made on a 31 mil thick FR-4 board with 1 ounce copper on both sides.

Part Identification Marking

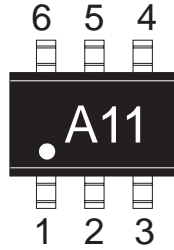

RoHS Compliant part indicated with a "A11Z" on part marking.

Alternate Marking with Trace Code Only

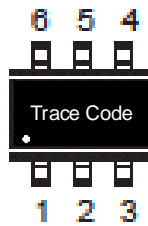

Ordering Information

Part Number	Reel Size	Devices/Reel
SGA-1163	7"	3000
SGA-1163Z	7"	3000

NOT FOR NEW DESIGN SIGNS

NOT FOR NEW DESIGNS