

MOSFET

650V CoolMOS™ CE Power Transistor

CoolMOS™ is a revolutionary technology for high voltage power MOSFETs, designed according to the superjunction (SJ) principle and pioneered by Infineon Technologies. CoolMOS™ CE series combines the experience of the leading SJ MOSFET supplier with high class innovation. The resulting devices provide all benefits of a fast switching Superjunction MOSFET while not sacrificing ease of use. Extremely low switching and conduction losses make switching applications even more efficient, more compact, lighter and cooler.

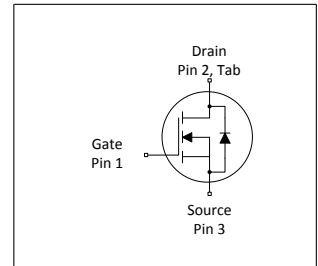
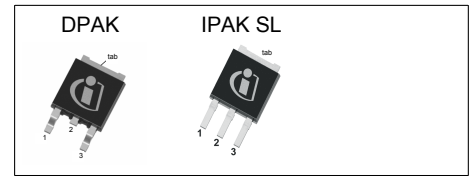

Features

- Extremely low losses due to very low FOM $R_{DS(on)} \cdot Q_g$ and E_{oss}
- Very high commutation ruggedness
- Easy to use/drive
- JEDEC qualified, Pb-free plating, Halogen free mold compound
- Qualified for standard grade applications

Applications

PFC stages, hard switching PWM stages and resonant switching stages for e.g. PC Silverbox, Adapter, LCD & PDP TV and indoor Lighting

Please note: For MOSFET paralleling the use of ferrite beads on the gate or separate totem poles is generally recommended.



Table 1 Key Performance Parameters

| Parameter | Value | Unit |
|----------------------|-------|------|
| $V_{DS} @ T_{j,max}$ | 700 | V |
| $R_{DS(on),max}$ | 400 | mΩ |
| I_D | 15.1 | A |
| $Q_{g,typ}$ | 39 | nC |
| $I_{D,pulse}$ | 30 | A |
| $E_{oss@400V}$ | 2.8 | μJ |

| Type / Ordering Code | Package | Marking | Related Links |
|----------------------|-----------|----------|----------------|
| IPD65R400CE | PG-TO 252 | 65S400CE | see Appendix A |
| IPS65R400CE | PG-TO 251 | | |

Table of Contents

| | |
|---|----|
| Description | 1 |
| Maximum ratings | 3 |
| Thermal characteristics | 4 |
| Electrical characteristics | 5 |
| Electrical characteristics diagrams | 7 |
| Test Circuits | 11 |
| Package Outlines | 12 |
| Appendix A | 14 |
| Revision History | 15 |
| Trademarks | 15 |
| Disclaimer | 15 |

1 Maximum ratings

at $T_j = 25^\circ\text{C}$, unless otherwise specified

Table 2 Maximum ratings

| Parameter | Symbol | Values | | | Unit | Note / Test Condition |
|---|---------------------|--------|------|-------------|------------------|---|
| | | Min. | Typ. | Max. | | |
| Continuous drain current ¹⁾ | I_D | - | - | 15.1 9.5 | A | $T_C=25^\circ\text{C}$ $T_C=100^\circ\text{C}$ |
| Pulsed drain current ²⁾ | $I_{D,pulse}$ | - | - | 30 | A | $T_C=25^\circ\text{C}$ |
| Avalanche energy, single pulse | E_{AS} | - | - | 215 | mJ | $I_D=1.8\text{A}$; $V_{DD}=50\text{V}$; see table 10 |
| Avalanche energy, repetitive | E_{AR} | - | - | 0.32 | mJ | $I_D=1.8\text{A}$; $V_{DD}=50\text{V}$; see table 10 |
| Avalanche current, repetitive | I_{AR} | - | - | 1.8 | A | - |
| MOSFET dv/dt ruggedness | dv/dt | - | - | 50 | V/ns | $V_{DS}=0\dots480\text{V}$ |
| Gate source voltage (static) | V_{GS} | -20 | - | 20 | V | static; |
| Gate source voltage (dynamic) | V_{GS} | -30 | - | 30 | V | AC ($f>1\text{ Hz}$) |
| Power dissipation (Non FullPAK) TO-252, TO-251 | P_{tot} | - | - | 118 | W | $T_C=25^\circ\text{C}$ |
| Storage temperature | T_{stg} | -55 | - | 150 | $^\circ\text{C}$ | - |
| Operating junction temperature | T_j | -55 | - | 150 | $^\circ\text{C}$ | - |
| Continuous diode forward current | I_S | - | - | 10.6 | A | $T_C=25^\circ\text{C}$ |
| Diode pulse current ²⁾ | $I_{S,pulse}$ | - | - | 30 | A | $T_C=25^\circ\text{C}$ |
| Reverse diode dv/dt ³⁾ | dv/dt | - | - | 15 | V/ns | $V_{DS}=0\dots400\text{V}$, $I_{SD}\leq I_S$, $T_j=25^\circ\text{C}$ see table 8 |
| Maximum diode commutation speed | di _f /dt | - | - | 500 | A/ μs | $V_{DS}=0\dots400\text{V}$, $I_{SD}\leq I_S$, $T_j=25^\circ\text{C}$ see table 8 |

¹⁾ Limited by $T_{j,max}$. Maximum duty cycle $D=0.50$

²⁾ Pulse width t_p limited by $T_{j,max}$

³⁾ Identical low side and high side switch with identical R_G

2 Thermal characteristics

Table 3 Thermal characteristics

| Parameter | Symbol | Values | | | Unit | Note / Test Condition |
|--|------------|--------|------|------|------|-------------------------------------|
| | | Min. | Typ. | Max. | | |
| Thermal resistance, junction - case | R_{thJC} | - | - | 1.06 | °C/W | - |
| Thermal resistance, junction - ambient | R_{thJA} | - | - | 62 | °C/W | leaded |
| Soldering temperature, wavesoldering only allowed at leads | T_{sold} | - | - | 260 | °C | 1.6mm (0.063 in.) from case for 10s |

3 Electrical characteristics

at $T_j=25^\circ\text{C}$, unless otherwise specified

Table 4 Static characteristics

| Parameter | Symbol | Values | | | Unit | Note / Test Condition |
|----------------------------------|---------------|--------|--------------|------|---------------|---|
| | | Min. | Typ. | Max. | | |
| Drain-source breakdown voltage | $V_{(BR)DSS}$ | 650 | - | - | V | $V_{GS}=0V, I_D=1mA$ |
| Gate threshold voltage | $V_{(GS)th}$ | 2.5 | 3.0 | 3.5 | V | $V_{DS}=V_{GS}, I_D=0.32mA$ |
| Zero gate voltage drain current | I_{DSS} | - | - | 1 | μA | $V_{DS}=650, V_{GS}=0V, T_j=25^\circ\text{C}$ $V_{DS}=650, V_{GS}=0V, T_j=150^\circ\text{C}$ |
| Gate-source leakage current | I_{GSS} | - | - | 100 | nA | $V_{GS}=20V, V_{DS}=0V$ |
| Drain-source on-state resistance | $R_{DS(on)}$ | - | 0.36 0.94 | 0.40 | Ω | $V_{GS}=10V, I_D=3.2435A, T_j=25^\circ\text{C}$ $V_{GS}=10V, I_D=3.2435A, T_j=150^\circ\text{C}$ |
| Gate resistance | R_G | - | 7.5 | - | Ω | $f=1\text{MHz}$, open drain |

Table 5 Dynamic characteristics

| Parameter | Symbol | Values | | | Unit | Note / Test Condition |
|--|--------------|--------|------|------|------|--|
| | | Min. | Typ. | Max. | | |
| Input capacitance | C_{iss} | - | 710 | - | pF | $V_{GS}=0V, V_{DS}=100V, f=1\text{MHz}$ |
| Output capacitance | C_{oss} | - | 41 | - | pF | $V_{GS}=0V, V_{DS}=100V, f=1\text{MHz}$ |
| Effective output capacitance, energy related ¹⁾ | $C_{o(er)}$ | - | 32 | - | pF | $V_{GS}=0V, V_{DS}=0\dots480V$ |
| Effective output capacitance, time related ²⁾ | $C_{o(tr)}$ | - | 140 | - | pF | $I_D=\text{constant}, V_{GS}=0V, V_{DS}=0\dots480V$ |
| Turn-on delay time | $t_{d(on)}$ | - | 10 | - | ns | $V_{DD}=400V, V_{GS}=13V, I_D=4.86525A, R_G=4.9\Omega$; see table 9 |
| Rise time | t_r | - | 7 | - | ns | $V_{DD}=400V, V_{GS}=13V, I_D=4.86525A, R_G=4.9\Omega$; see table 9 |
| Turn-off delay time | $t_{d(off)}$ | - | 57 | - | ns | $V_{DD}=400V, V_{GS}=13V, I_D=4.86525A, R_G=4.9\Omega$; see table 9 |
| Fall time | t_f | - | 8 | - | ns | $V_{DD}=400V, V_{GS}=13V, I_D=4.86525A, R_G=4.9\Omega$; see table 9 |

Table 6 Gate charge characteristics

| Parameter | Symbol | Values | | | Unit | Note / Test Condition |
|-----------------------|---------------|--------|------|------|------|--|
| | | Min. | Typ. | Max. | | |
| Gate to source charge | Q_{gs} | - | 4 | - | nC | $V_{DD}=480V, I_D=4.86525A, V_{GS}=0$ to 10V |
| Gate to drain charge | Q_{gd} | - | 20 | - | nC | $V_{DD}=480V, I_D=4.86525A, V_{GS}=0$ to 10V |
| Gate charge total | Q_g | - | 39 | - | nC | $V_{DD}=480V, I_D=4.86525A, V_{GS}=0$ to 10V |
| Gate plateau voltage | $V_{plateau}$ | - | 5.5 | - | V | $V_{DD}=480V, I_D=4.86525A, V_{GS}=0$ to 10V |

¹⁾ $C_{o(er)}$ is a fixed capacitance that gives the same stored energy as C_{oss} while V_{DS} is rising from 0 to 480V

²⁾ $C_{o(tr)}$ is a fixed capacitance that gives the same charging time as C_{oss} while V_{DS} is rising from 0 to 480V

Table 7 Reverse diode characteristics

| Parameter | Symbol | Values | | | Unit | Note / Test Condition |
|-------------------------------|-----------|--------|------|------|---------|--|
| | | Min. | Typ. | Max. | | |
| Diode forward voltage | V_{SD} | - | 0.9 | - | V | $V_{GS}=0V, I_F=4.9A, T_j=25^\circ C$ |
| Reverse recovery time | t_{rr} | - | 280 | - | ns | $V_R=400V, I_F=4.9A, di_F/dt=100A/\mu s$; see table 19 |
| Reverse recovery charge | Q_{rr} | - | 2.8 | - | μC | $V_R=400V, I_F=4.9A, di_F/dt=100A/\mu s$; see table 19 |
| Peak reverse recovery current | I_{rrm} | - | 17 | - | A | $V_R=400V, I_F=4.9A, di_F/dt=100A/\mu s$; see table 19 |

4 Electrical characteristics diagrams

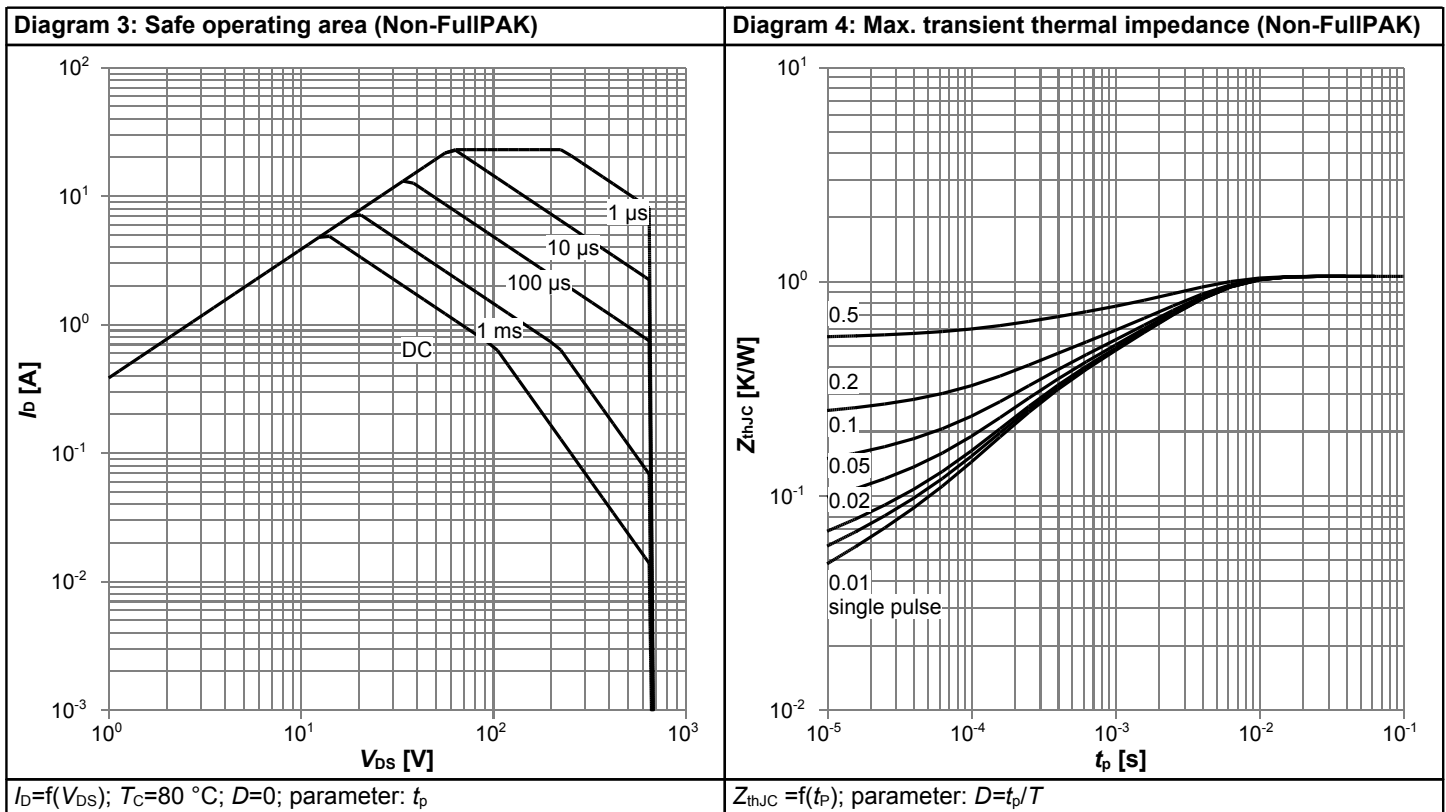
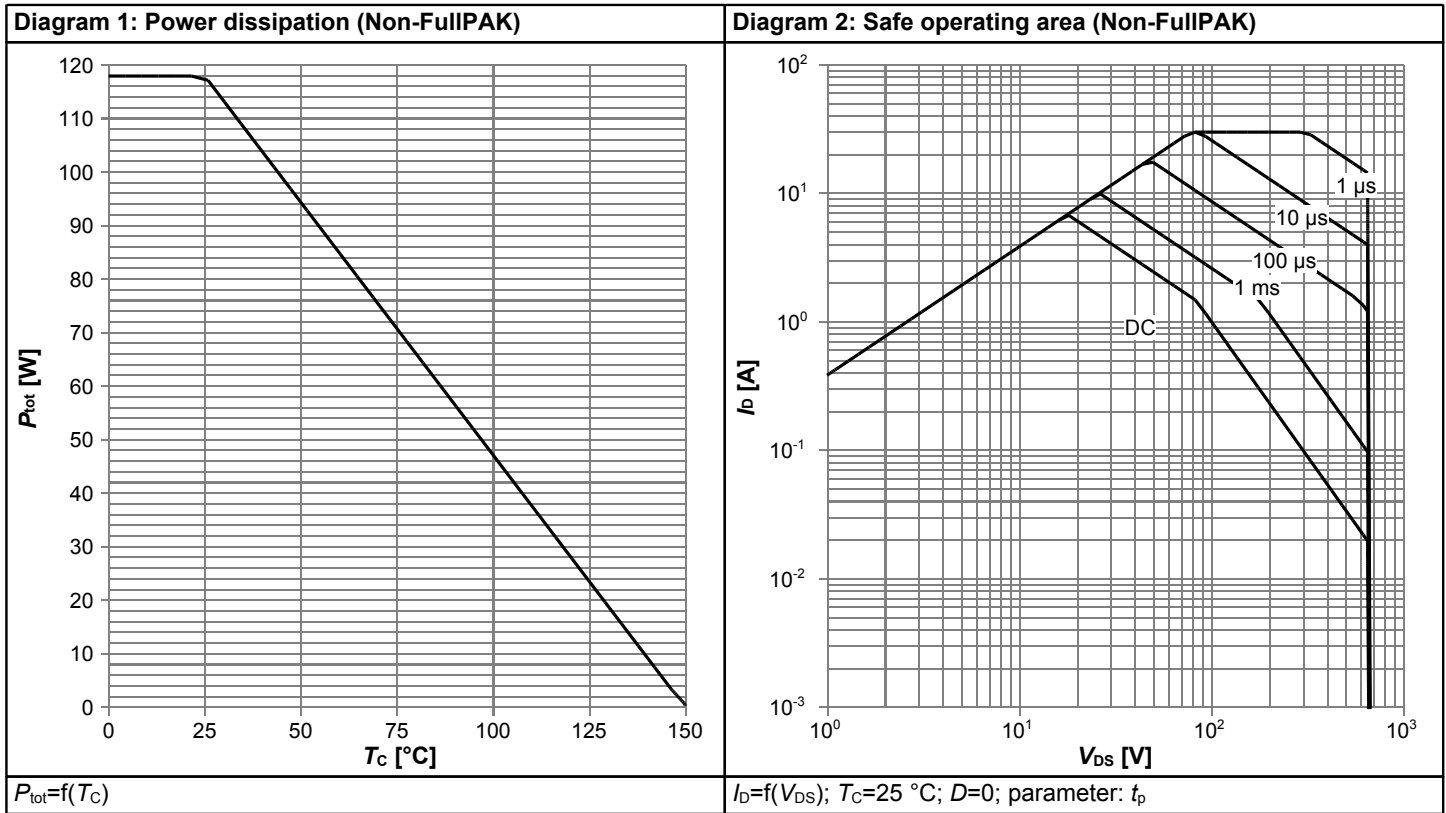

650V CoolMOS™ CE Power Transistor

IPD65R400CE, IPS65R400CE

Diagram 5: Typ. output characteristics

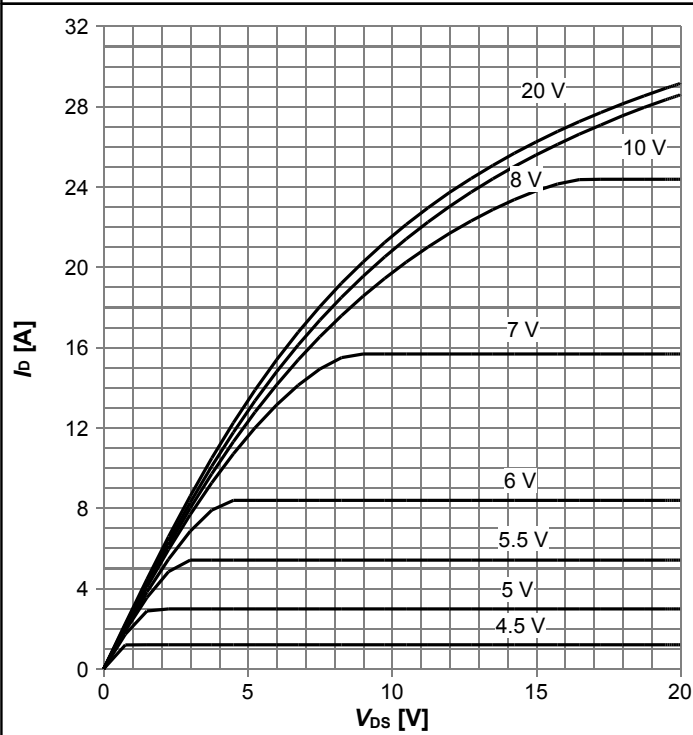

$I_D=f(V_{DS}); T_j=25\text{ °C};$ parameter: V_{GS}

Diagram 6: Typ. output characteristics

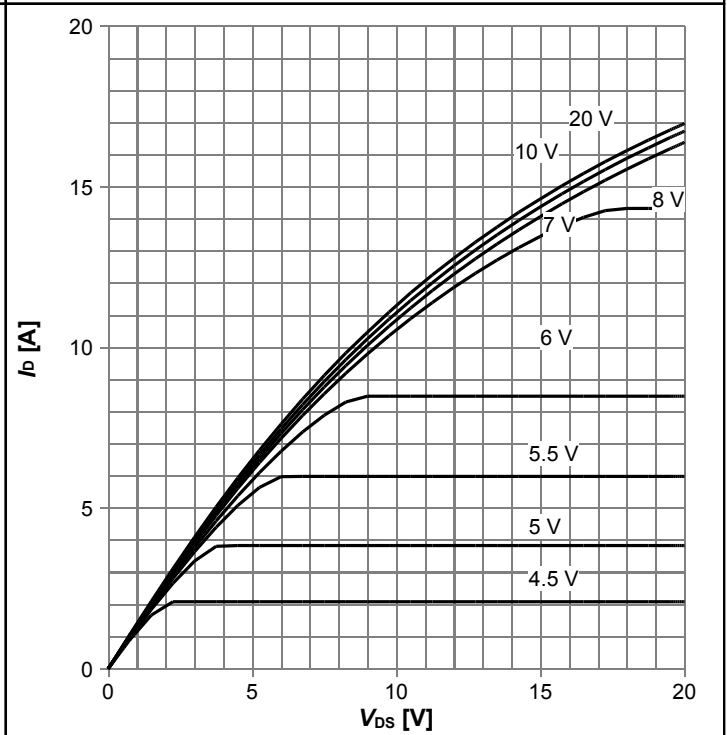

$I_D=f(V_{DS}); T_j=125\text{ °C};$ parameter: V_{GS}

Diagram 7: Typ. drain-source on-state resistance

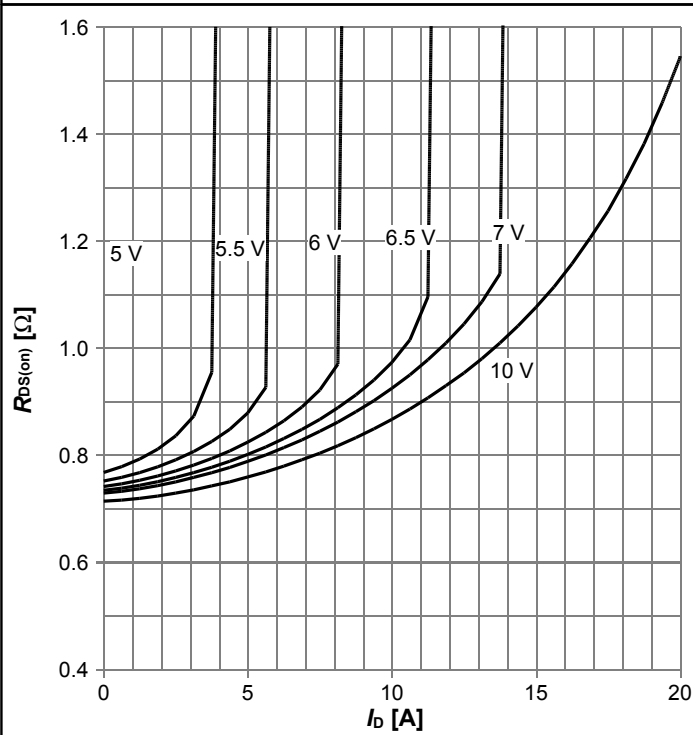

$R_{DS(on)}=f(I_D); T_j=125\text{ °C};$ parameter: V_{GS}

Diagram 8: Drain-source on-state resistance

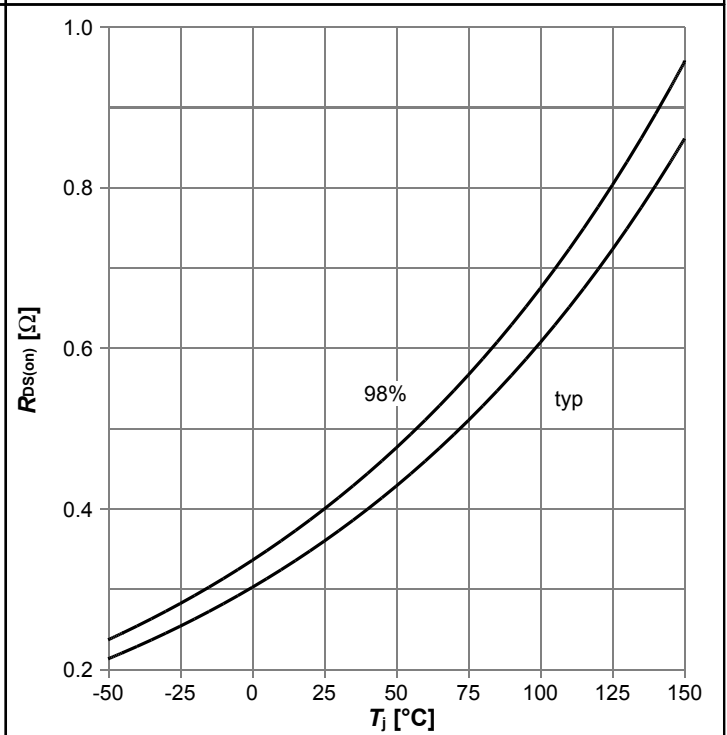

$R_{DS(on)}=f(T_j); I_D=3.2\text{ A}; V_{GS}=10\text{ V}$

650V CoolMOS™ CE Power Transistor
IPD65R400CE, IPS65R400CE

Diagram 9: Typ. transfer characteristics

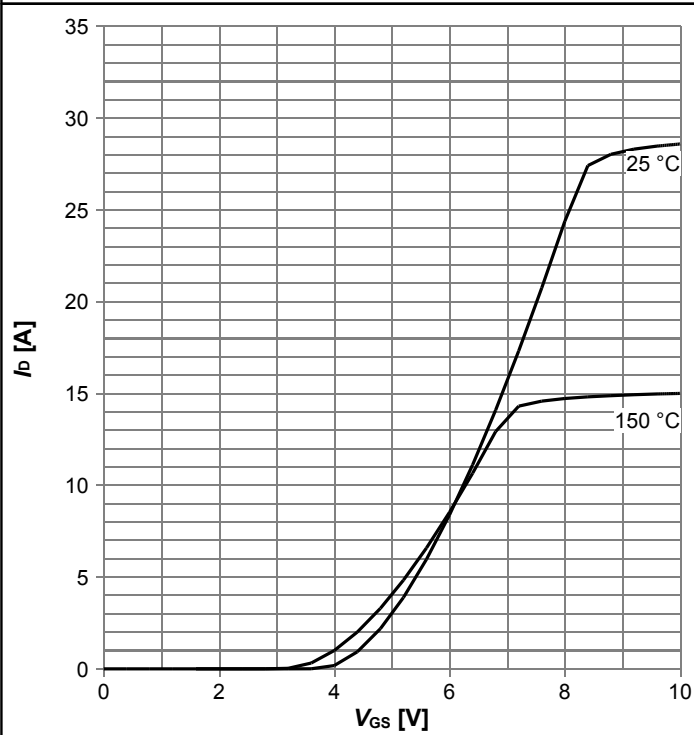

$I_D = f(V_{GS})$; $V_{DS} = 20V$; parameter: T_j

Diagram 10: Typ. gate charge

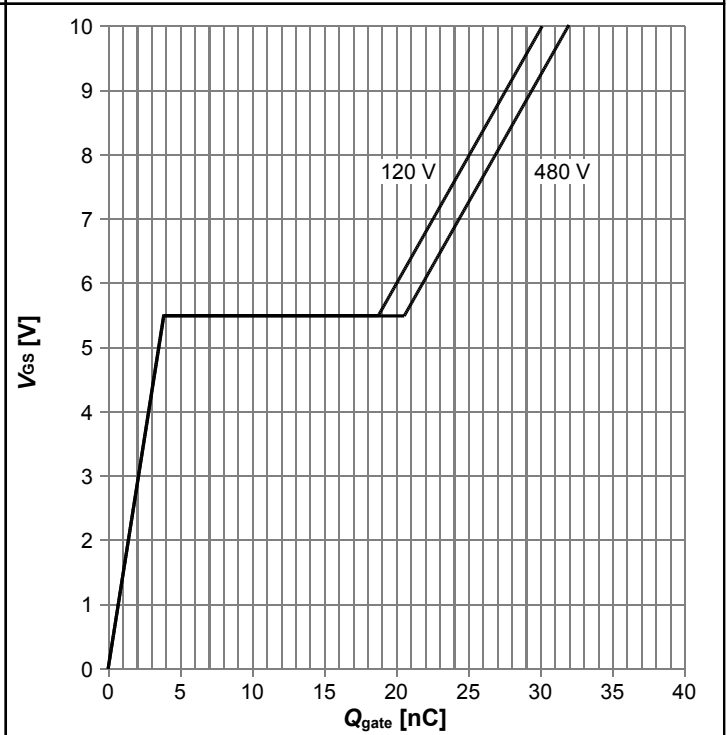

$V_{GS} = f(Q_{gate})$; $I_D = 4.9 A$ pulsed; parameter: V_{DD}

Diagram 11: Forward characteristics of reverse diode

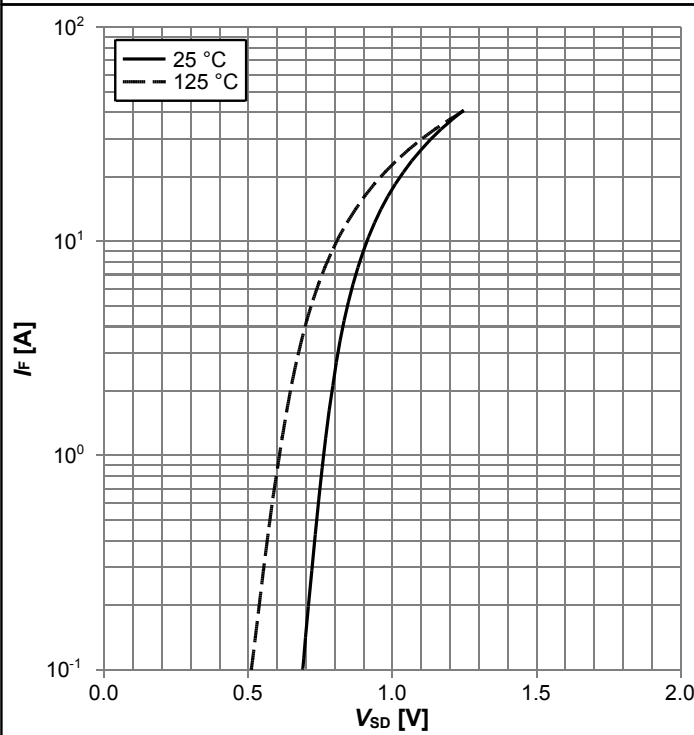

$I_F = f(V_{SD})$; parameter: T_j

Diagram 12: Avalanche energy

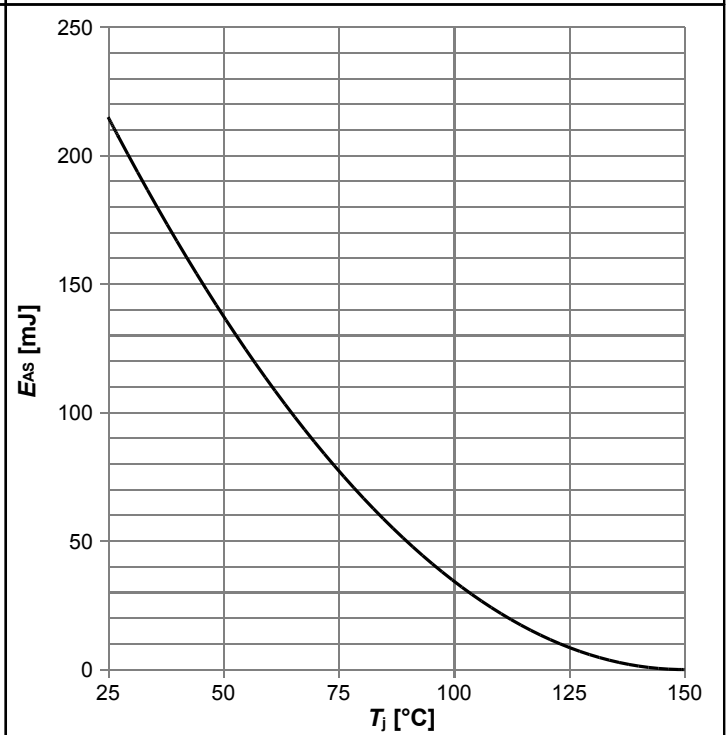

$E_{AS} = f(T_j)$; $I_D = 1.8 A$; $V_{DD} = 50 V$

650V CoolMOS™ CE Power Transistor
IPD65R400CE, IPS65R400CE

Diagram 13: Drain-source breakdown voltage

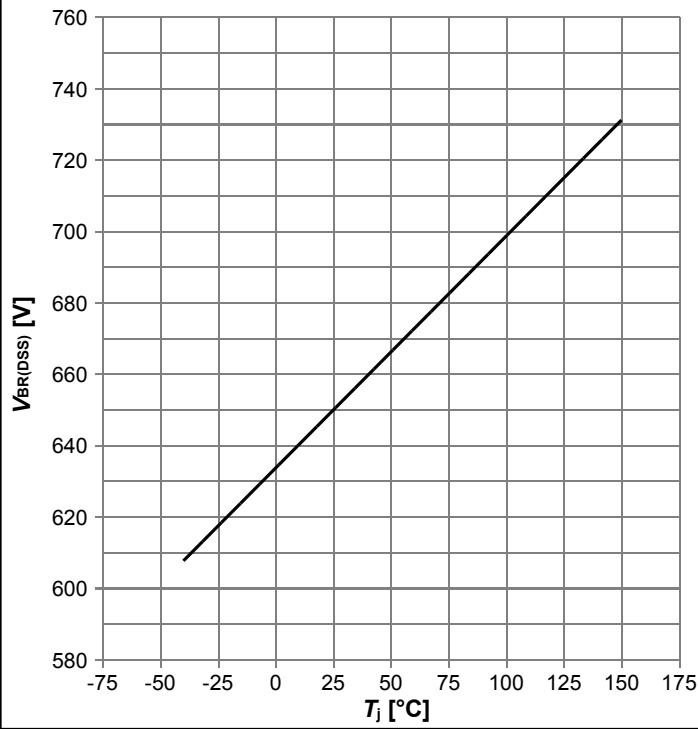

$V_{BR(DSS)}=f(T_j); I_D=1\text{ mA}$

Diagram 14: Typ. capacitances

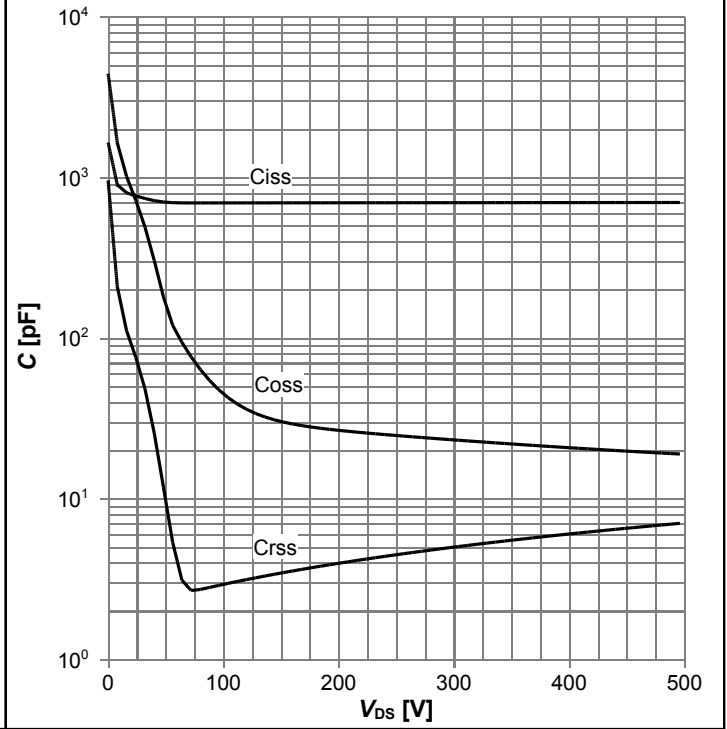

$C=f(V_{DS}); V_{GS}=0\text{ V}; f=1\text{ MHz}$

Diagram 15: Typ. Coss stored energy

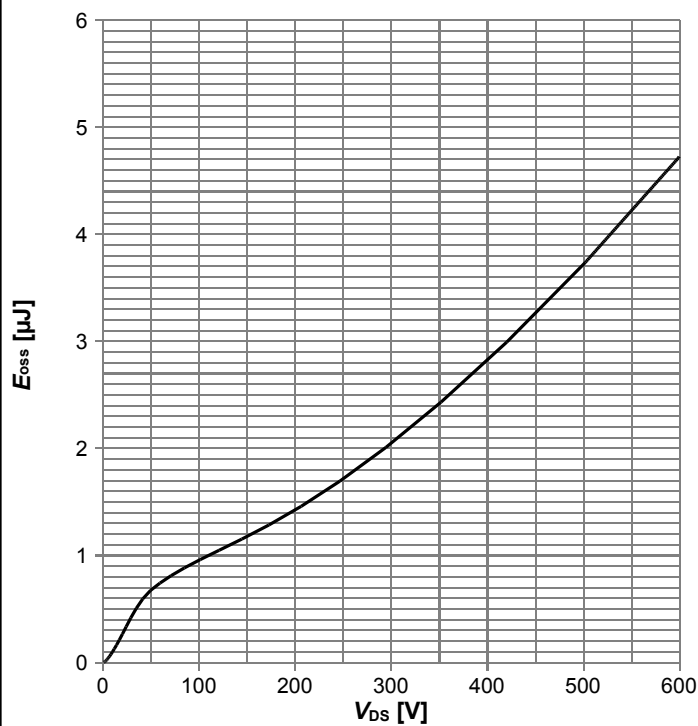

$E_{oss}=f(V_{DS})$

5 Test Circuits

Table 8 Diode characteristics

| Test circuit for diode characteristics | Diode recovery waveform |
|--|-------------------------|
| | |

Table 9 Switching times

| Switching times test circuit for inductive load | Switching times waveform |
|---|--------------------------|
| | |

Table 10 Unclamped inductive load

| Unclamped inductive load test circuit | Unclamped inductive waveform |
|---------------------------------------|------------------------------|
| | |

6 Package Outlines

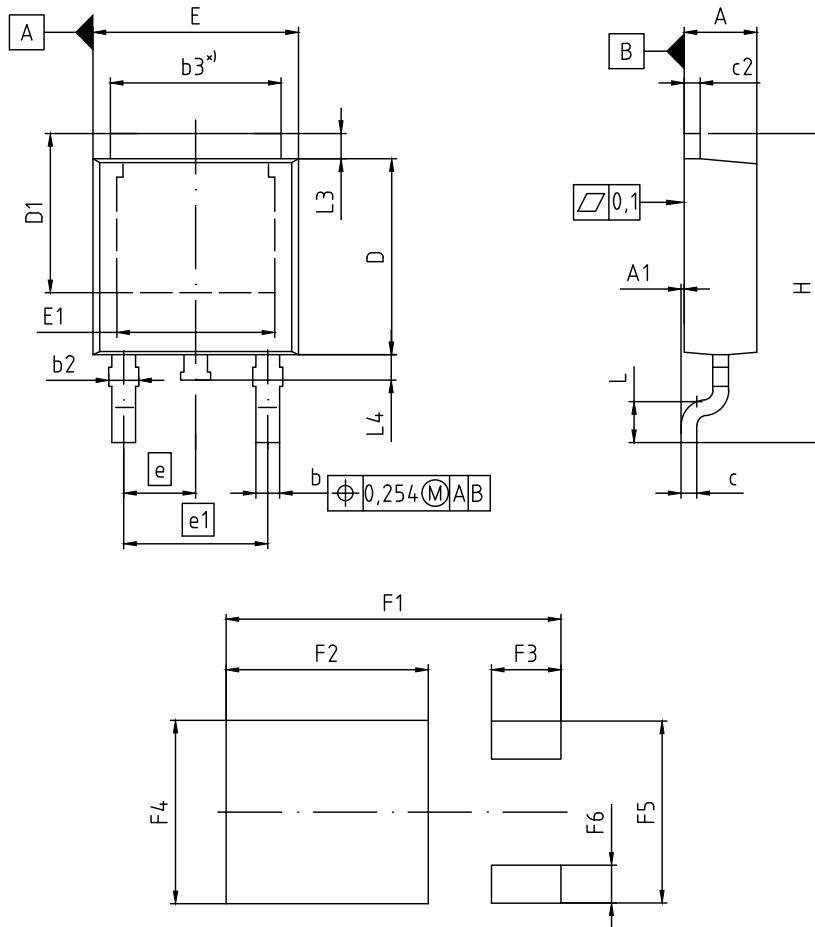

*) mold flash not included

| DIM | MILLIMETERS | | INCHES | |
|-----|-------------|-------|-------------|-------|
| | MIN | MAX | MIN | MAX |
| A | 2.16 | 2.41 | 0.085 | 0.095 |
| A1 | 0.00 | 0.15 | 0.000 | 0.006 |
| b | 0.64 | 0.89 | 0.025 | 0.035 |
| b2 | 0.65 | 1.15 | 0.026 | 0.045 |
| b3 | 5.00 | 5.50 | 0.197 | 0.217 |
| c | 0.46 | 0.60 | 0.018 | 0.024 |
| c2 | 0.46 | 0.98 | 0.018 | 0.039 |
| D | 5.97 | 6.22 | 0.235 | 0.245 |
| D1 | 5.02 | 5.84 | 0.198 | 0.230 |
| E | 6.40 | 6.73 | 0.252 | 0.265 |
| E1 | 4.70 | 5.60 | 0.185 | 0.220 |
| e | 2.29 (BSC) | | 0.090 (BSC) | |
| e1 | 4.57 (BSC) | | 0.180 (BSC) | |
| N | 3 | | 3 | |
| H | 9.40 | 10.48 | 0.370 | 0.413 |
| L | 1.18 | 1.70 | 0.046 | 0.067 |
| L3 | 0.90 | 1.25 | 0.035 | 0.049 |
| L4 | 0.51 | 1.00 | 0.020 | 0.039 |
| F1 | 10.60 | | 0.417 | |
| F2 | 6.40 | | 0.252 | |
| F3 | 2.20 | | 0.087 | |
| F4 | 5.80 | | 0.228 | |
| F5 | 5.76 | | 0.227 | |
| F6 | 1.20 | | 0.047 | |

| |
|------------------------------------|
| DOCUMENT NO. Z8B00003328 |
| SCALE 0 2.0 4mm |
| EUROPEAN PROJECTION |
| ISSUE DATE 01-09-2015 |
| REVISION 05 |

Figure 1 Outline PG-TO 252, dimensions in mm/inches

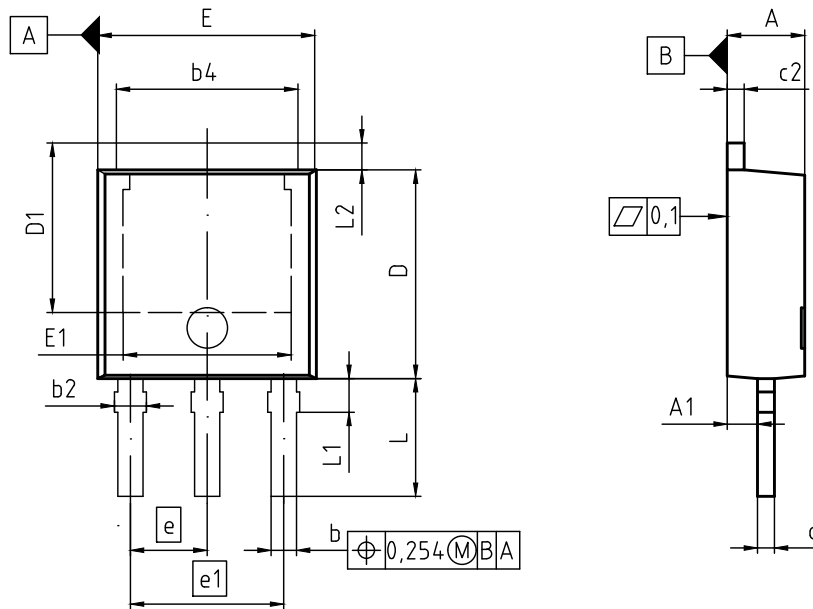

| DIM | MILLIMETERS | | INCHES | |
|-----|-------------|------|--------|-------|
| | MIN | MAX | MIN | MAX |
| A | 2.18 | 2.40 | 0.086 | 0.094 |
| A1 | 0.80 | 1.14 | 0.031 | 0.045 |
| b | 0.64 | 0.89 | 0.025 | 0.035 |
| b2 | 0.65 | 1.15 | 0.026 | 0.045 |
| b4 | 4.95 | 5.50 | 0.195 | 0.217 |
| c | 0.46 | 0.59 | 0.018 | 0.023 |
| c2 | 0.46 | 0.89 | 0.018 | 0.035 |
| D | 5.97 | 6.22 | 0.235 | 0.245 |
| D1 | 5.04 | 5.55 | 0.198 | 0.219 |
| E | 6.35 | 6.73 | 0.250 | 0.265 |
| E1 | 4.60 | 5.21 | 0.181 | 0.205 |
| e | 2.29 | | 0.090 | |
| e1 | 4.57 | | 0.180 | |
| N | 3 | | 3 | |
| L | 3.00 | 3.60 | 0.118 | 0.142 |
| L1 | 0.80 | 1.25 | 0.031 | 0.049 |
| L2 | 0.88 | 1.28 | 0.035 | 0.050 |

DOCUMENT NO.
Z8B00003329

SCALE

EUROPEAN PROJECTION

ISSUE DATE
21-10-2015

REVISION
06

Figure 2 Outline PG-TO 251, dimensions in mm/inches

7 Appendix A

Table 11 Related Links

- IFX CoolMOS™ CE Webpage: www.infineon.com
- IFX CoolMOS™ CE application note: www.infineon.com
- IFX CoolMOS™ CE simulation model: www.infineon.com
- IFX Design tools: www.infineon.com

650V CoolMOS™ CE Power Transistor

IPD65R400CE, IPS65R400CE

Revision History

IPD65R400CE, IPS65R400CE

Revision: 2016-02-23, Rev. 2.0

Previous Revision

| Revision | Date | Subjects (major changes since last revision) |
|----------|------------|--|
| 2.0 | 2016-02-23 | Release of final version |

Trademarks of Infineon Technologies AG

AURIX™, C166™, CanPAK™, CIPOS™, CoolGaN™, CoolMOS™, CoolSET™, CoolSiC™, CORECONTROL™, CROSSAVE™, DAVE™, DI-POL™, DrBlade™, EasyPIM™, EconoBRIDGE™, EconoDUAL™, EconoPACK™, EconoPIM™, EiceDRIVER™, eupec™, FCOS™, HITFET™, HybridPACK™, Infineon™, ISOFACE™, IsoPACK™, i-Wafer™, MIPAQ™, ModSTACK™, my-d™, NovalithIC™, OmniTune™, OPTIGA™, OptiMOS™, ORIGA™, POWERCODE™, PRIMARION™, PrimePACK™, PrimeSTACK™, PROFET™, PRO-SIL™, RASIC™, REAL3™, ReverSave™, SatRIC™, SIEGET™, SIPMOS™, SmartLEWIS™, SOLID FLASH™, SPOC™, TEMPFET™, thinQ!™, TRENCHSTOP™, TriCore™.

Trademarks updated August 2015

Other Trademarks

All referenced product or service names and trademarks are the property of their respective owners.

We Listen to Your Comments

Any information within this document that you feel is wrong, unclear or missing at all? Your feedback will help us to continuously improve the quality of this document. Please send your proposal (including a reference to this document) to:

erratum@infineon.com

Published by

Infineon Technologies AG

81726 München, Germany

© 2015 Infineon Technologies AG

All Rights Reserved.

Legal Disclaimer

The information given in this document shall in no event be regarded as a guarantee of conditions or characteristics. With respect to any examples or hints given herein, any typical values stated herein and/or any information regarding the application of the device, Infineon Technologies hereby disclaims any and all warranties and liabilities of any kind, including without limitation, warranties of non-infringement of intellectual property rights of any third party.

Information

For further information on technology, delivery terms and conditions and prices please contact your nearest Infineon Technologies Office (www.infineon.com).

Warnings

Due to technical requirements, components may contain dangerous substances. For information on the types in question, please contact the nearest Infineon Technologies Office.

The Infineon Technologies component described in this Data Sheet may be used in life-support devices or systems and/or automotive, aviation and aerospace applications or systems only with the express written approval of Infineon Technologies, if a failure of such components can reasonably be expected to cause the failure of that life-support, automotive, aviation and aerospace device or system or to affect the safety or effectiveness of that device or system. Life support devices or systems are intended to be implanted in the human body or to support and/or maintain and sustain and/or protect human life. If they fail, it is reasonable to assume that the health of the user or other persons may be endangered.