

# MOS FET Relays G3VM-201AY/DY

**Compact, General-purpose, Analog-switching MOS FET Relay, with Dielectric Strength of 5 kVAC between I/O Using Optical Isolation**

- Trigger LED forward current of 2 mA (max.)
- Switches minute analog signals
- Continuous load current of 250 mA
- RoHS Compliant.

### Application Examples

- Measurement devices
- Security systems and Power meters
- Industrial equipment

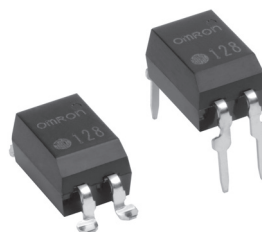

**NEW**

**Note:** The actual product is marked differently from the image shown here.

### List of Models

| Contact form | Terminals                  | Load voltage (peak value) | Model      | Number per stick | Number per tape |
|--------------|----------------------------|---------------------------|------------|------------------|-----------------|
| SPST-NO      | PCB terminals              | 200 V                     | G3VM-201AY | 100              | ---             |
|              | Surface-mounting terminals |                           | G3VM-201DY |                  |                 |
|              |                            |                           |            | G3VM-201DY(TR)   | ---             |

**Note:** The AC peak and DC value are given for the load voltage.

### Dimensions

**Note:** All units are in millimeters unless otherwise indicated.

#### G3VM-201AY

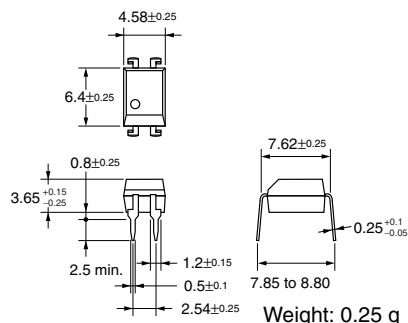

**Note:** The actual product is marked differently from the image shown here.

#### G3VM-201DY

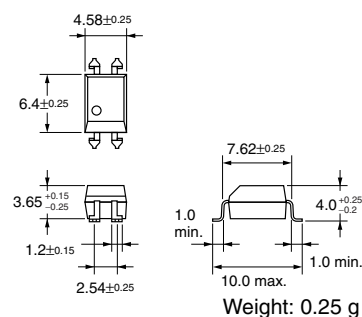

**Note:** The actual product is marked differently from the image shown here.

### Terminal Arrangement/Internal Connections (Top View)

#### G3VM-201AY

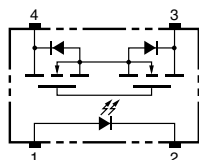

#### G3VM-201DY

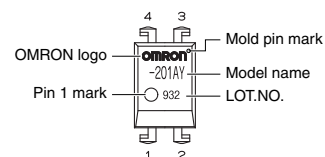
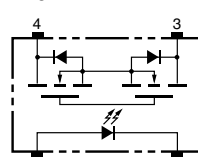

**Note:** The actual product is marked differently from the image shown here.

### PCB Dimensions (Bottom View)

#### G3VM-201AY

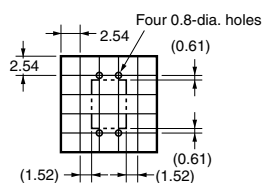

### Actual Mounting Pad Dimensions (Recommended Value, Top View)

#### G3VM-201DY

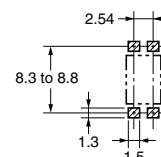

■ Absolute Maximum Ratings (Ta = 25°C)

| Item   | Symbol                               | Rating                         | Unit      | Measurement conditions        |                             |
|--|--------------------------------------|--------------------------------|-----------|-------------------------------|-----------------------------|
| Input  | LED forward current                  | $I_F$                          | 30        | mA                            |                             |
|  | Repetitive peak LED forward current  | $I_{FP}$                       | 1         | A                             | 100 $\mu$ s pulses, 100 pps |
|  | LED forward current reduction rate   | $\Delta I_F/^\circ\text{C}$    | -0.3      | mA/°C                         | Ta $\geq$ 25°C              |
|  | LED reverse voltage                  | $V_R$                          | 5         | V                             |                             |
|  | Connection temperature               | $T_j$                          | 125       | °C                            |                             |
| Output   | Load voltage (AC peak/DC)            | $V_{OFF}$                      | 200       | V                             |                             |
|  | Continuous load current (AC peak/DC) | $I_O$                          | 250       | mA                            |                             |
|  | ON current reduction rate            | $\Delta I_{ON}/^\circ\text{C}$ | -2.5      | mA/°C                         | Ta $\geq$ 25°C              |
|  | Pulse ON current                     | $I_{OP}$                       | 0.75      | A                             | t=100 mS                    |
|  | Connection temperature               | $T_j$                          | 125       | °C                            |                             |
| Dielectric strength between input and output (See note 1.) | $V_{I-O}$                            | 5,000                          | $V_{rms}$ | AC for 1 min                  |                             |
| Operating temperature                                      | $T_a$                                | -40 to +85                     | °C        | With no icing or condensation |                             |
| Storage temperature  | $T_{stg}$                            | -55 to +125                    | °C        | With no icing or condensation |                             |
| Soldering temperature (10 s)                               | ---                                  | 260                            | °C        | 10 s                          |                             |

Note: 1. The dielectric strength between the input and output was checked by applying voltage between all pins as a group on the LED side and all pins as a group on the light-receiving side.

■ Electrical Characteristics (Ta = 25°C)

| Item                           | Symbol                                 | Minimum    | Typical | Maximum | Unit       | Measurement conditions  |  |
|--------------------------------|--|------------|---------|---------|------------|---|--|
| Input                          | LED forward voltage                    | $V_F$      | 1.45    | 1.63    | 1.75       | V   | $I_F = 10$ mA                            |
|                                | Reverse current                        | $I_R$      | ---     | ---     | 10         | $\mu$ A   | $V_R = 5$ V                              |
|                                | Capacity between terminals             | $C_T$      | ---     | 40      | ---        | pF  | V = 0, f = 1 MHz                         |
|                                | Trigger LED forward current            | $I_{FT}$   | ---     | 0.3     | 2          | mA  | $I_O = 250$ mA                           |
| Output                         | Maximum resistance with output ON      | $R_{ON}$   | ---     | 5       | 8          | $\Omega$  | $I_F = 5$ mA,<br>$I_O = 250$ mA, t < 1 s |
|                                | Current leakage when the relay is open | $I_{LEAK}$ | ---     | ---     | 1.0        | $\mu$ A   | $V_{OFF} = 200$ V                        |
|                                | Capacity between terminals             | $C_{OFF}$  | ---     | 90      | ---        | pF  | V = 0, f = 1 MHz                         |
| Capacity between I/O terminals | $C_{I-O}$                              | ---        | 0.8     | ---     | pF         | f = 1 MHz, $V_s = 0$ V  |  |
| Insulation resistance          | $R_{I-O}$                              | 1,000      | ---     | ---     | M $\Omega$ | $V_{I-O} = 500$ VDC,<br>$R_{OH} \leq 60\%$                            |  |
| Turn-ON time                   | $t_{ON}$                               | ---        | 0.5     | 1.0     | ms         | $I_F = 5$ mA, $R_L = 200$ $\Omega$ ,<br>$V_{DD} = 20$ V (See note 2.) |  |
| Turn-OFF time                  | $t_{OFF}$                              | ---        | 0.2     | 1.0     | ms         |   |  |

Note: 2. Turn-ON and Turn-OFF Times

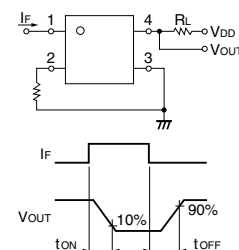

■ Recommended Operating Conditions

Use the G3VM under the following conditions so that the Relay will operate properly.

| Item                                 | Symbol   | Minimum | Typical | Maximum | Unit |
|--------------------------------------|----------|---------|---------|---------|------|
| Load voltage (AC peak/DC)            | $V_{DD}$ | ---     | ---     | 160     | V    |
| Operating LED forward current        | $I_F$    | 3       | 5       | 20      | mA   |
| Continuous load current (AC peak/DC) | $I_O$    | ---     | ---     | 250     | mA   |
| Operating temperature                | $T_a$    | -20     | ---     | 65      | °C   |

■ Engineering Data

LED forward current vs. Ambient temperature

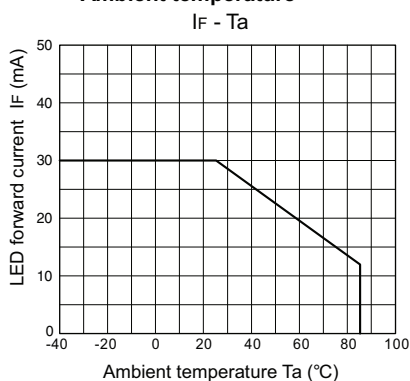

Continuous load current vs. Ambient temperature

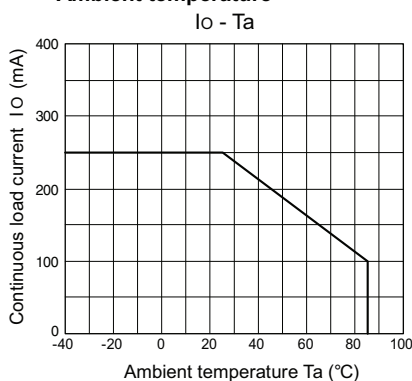

LED forward current vs. LED forward voltage

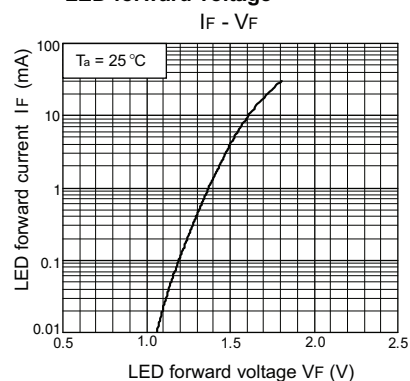

Continuous load current vs. On-state voltage

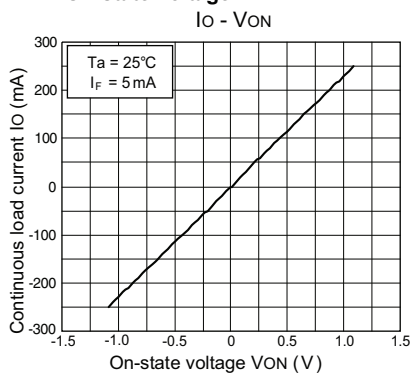

On-state resistance vs. Ambient temperature

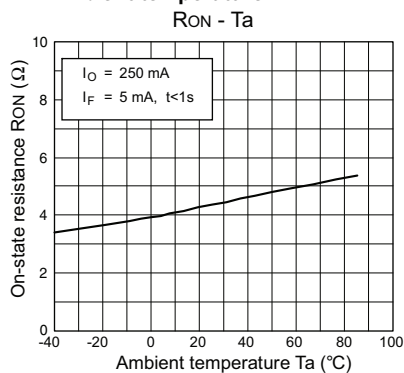

Trigger LED forward current vs. Ambient temperature

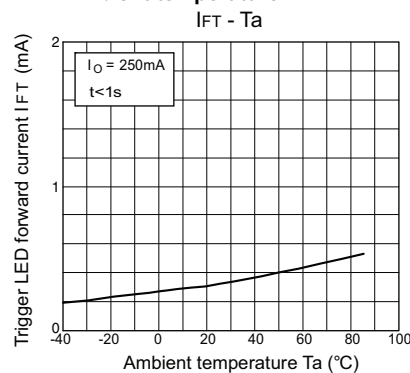

Turn ON, Turn OFF time vs. LED forward current

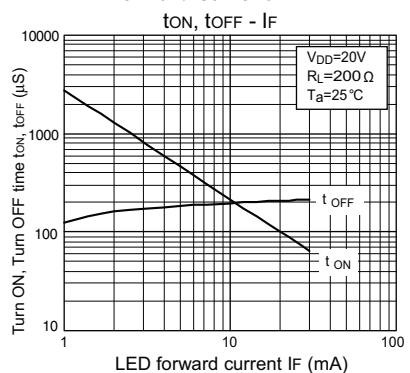

Turn ON, Turn OFF time vs. Ambient temperature

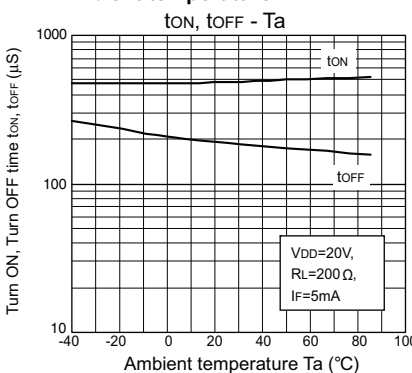

Current leakage vs. Ambient temperature

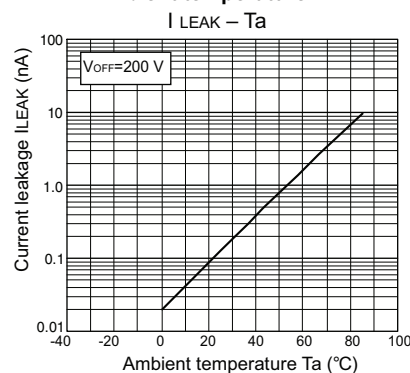

All sales are subject to Omron Electronic Components LLC standard terms and conditions of sale, which can be found at [http://www.components.omron.com/components/web/webfiles.nsf/sales\\_terms.html](http://www.components.omron.com/components/web/webfiles.nsf/sales_terms.html)

**ALL DIMENSIONS SHOWN ARE IN MILLIMETERS.**  
To convert millimeters into inches, multiply by 0.03937. To convert grams into ounces, multiply by 0.03527.

---

**OMRON**<sup>®</sup>  
**OMRON ELECTRONIC  
COMPONENTS LLC**  
55 E. Commerce Drive, Suite B  
Schaumburg, IL 60173  
**847-882-2288**

**OMRON ON-LINE**  
Global - <http://www.omron.com>  
USA - <http://www.components.omron.com>

Cat. No. G3VM-201AY/DY\_1      11/11      Specifications subject to change without notice      Printed in USA