

Nanopower Buck-Boost DC/DC with Integrated Coulomb Counter

DESCRIPTION

Demonstration circuit DC2343A is a complete system level solution for a nanopower buck-boost DC/DC with integrated coulomb counter. The DC2343A contains a PIC16F1459 embedded processor for communication to the PC over USB and the LTC[®]3335 via its I²C port. The GUI is capable of reading and writing all the control registers on the LTC3335 as well as displaying and resetting all its alarm registers. The firmware and software for the embedded system and the GUI are available at the LTC3335 [solutions page](#). The DC2343A uses two analog-to-digital converter channels to sample the battery and output voltages. The voltage samples improve the functionality of the GUI, and allow optimal software correction to the measured coulombs. By adding the software correction the first order known errors are compensated for over the operating range and the resultant coulomb count is accurate to within 3%.

The DC2343A contains an LTC3335 which is a high efficiency, low quiescent current (680nA) buck-boost DC/DC

converter with an integrated precision coulomb counter which monitors accumulated battery discharge in long life battery powered applications. The buck-boost can operate down to 1.8V on its input and provides eight pin selectable output voltages with up to 50mA of output current. The coulomb counter stores the accumulated battery discharge in an internal register accessible via an I²C interface. The LTC3335 features a programmable discharge alarm threshold. When the threshold is reached, an interrupt is generated at the \overline{IRQ} pin. To accommodate a wide range of battery types and sizes, the peak input current can be selected from as low as 5mA to as high as 250mA and the full-scale coulomb counter has a range from 1.1mAh (with 5mA I_{PEAK}) to 1793Ah (with 250mA I_{PEAK}).

Design files for this circuit board are available at <http://www.linear.com/demo/DC2343A>

LT, LT, LTC, LTM, Linear Technology and the Linear logo are registered trademarks and QuikEval is a trademark of Linear Technology Corporation. All other trademarks are the property of their respective owners.

PERFORMANCE SUMMARY Specifications are at T_A = 25°C

PARAMETER	CONDITIONS	MIN	TYP	MAX	UNITS
Input Supply Range, V _{BAT}		1.8	-	5.5	V
Buck-Boost Peak Current Limit	L1 = 100μH, R1 = R4 = R5 = Installed		100		mA
V _{OUT} Output Voltage	OUT2 = 1, OUT1 = OUT0 = 0		3.3		V
Max Output Current			15		mA
Efficiency	V _{BAT} = 3.6V, V _{OUT} = 3.3V, I _{OUT} = 10mA		86		%

OPERATING PRINCIPLE

The demo board is pictured in Figure 2a and Figure 2b, with schematics shown in Figure 18 and Figure 19. The provided USB cable connects the demo board to the PC. With Linear Technology's QuikEval™ program running in the background of the PC, a five windowed GUI, pictured in Figure 6 will pop up.

The GUI sends high level commands to the onboard microcontroller via the USB interface. The GUI receives the raw LTC3335 register values and converts them into application values, which are easily understood by the user. The GUI also writes to the internal registers to set the accumulator value and the accumulator alarm threshold.

The board is shipped with a peak buck-boost inductor current of 100mA and an output voltage setting of 3.3V. The board is configurable via jumpers to set the output voltage between 1.8V and 5V. Using a soldering iron to change the location of some 0Ω resistors and a different value inductor for the buck-boost converter, the board can be modified to accommodate 5mA to 250mA peak inductor current settings. This flexibility is very helpful when working with higher-impedance batteries such as the Tadiran primary lithium-thionyl chloride (Li-SOCl₂) long life batteries.

The demo board can be controlled by the GUI or by an external processor. When the jumper assembly on JP5 is in the B-C location the internal processor is connected to the LTC3335 device and the GUI is able to monitor the status of the registers. The B-C location is the default for the DC2343A, as the PIC16 may consume current if left connected to the LTC3335 without the USB cable attached. When the jumper assembly on JP5 is moved to the A-B location, the onboard processor is disconnected from the LTC3335. When in this location row C pins can be used to control and monitor the LTC3335 via an external processor.

The measurement of the V_{BAT} and the V_{OUT} voltages is done with a sampled ADC reading to minimize power dissipation and maintain the available accuracy from the processor ADC. Refer to page two of the schematic and the V_{BAT} voltage measurement components for the following discussion. Resistor R18 and capacitor C11 form a 1.6kHz low-pass filter to remove the high frequency switching noise from the V_{BAT} measurement. M1 is a combination of a PFET and NFET configured with the PFET as a pass device and the NFET along with resistor R24 performing the function of a level translator to turn on and off the PFET with the GN1 signal. This allows the use of relatively low valued resistors (R25 and R26) as the divider resistors into the ADC. The divider resistors are needed to keep the input signal within the input range of the ADC (0V to 4.096V). For the processor used on the board the, input resistance to the ADC is recommended to be less than or equal to 10kΩ. Both voltage sampling circuits (V_{BAT} and V_{OUT}) are controlled by the same signal. At a 3 second sampling rate, the PFETs are turned on for 120μs to perform the ADC conversions. Performing both conversions within 120μs every 3 seconds can add as much as 35nA to the input current under worst-case conditions when the battery is at 1.8V and the output voltage is set to 5V. Under normal operation where the battery is 3.6V and the output voltage is 3.3V, the voltage sampling adds approximately 15nA to the input current.

For a more details about the operation of the LTC3335 IC please, refer to the LTC3335 data sheet.

Connecting a DC9003A-B Dust Mote

When connecting a DC9003A-B Dust mote to the DC2343A demo board, two resistors in the Dust mote must be changed for the mote to switch over from the battery power to the output of the LTC3335, when PGOOD goes high. Change resistor R3 to 750kΩ and change R4 to 5.1MΩ, on the Dust mote demo board. In addition, connect J3 Pin 3 to E6 (GND).

OPERATING PRINCIPLE

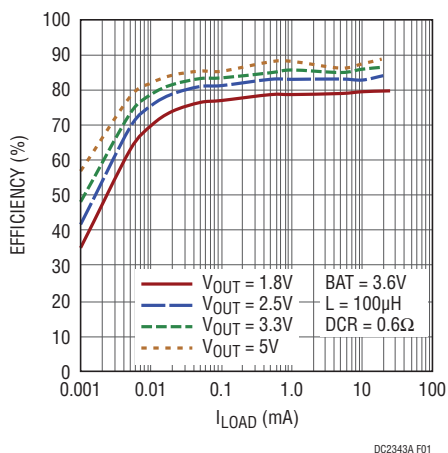
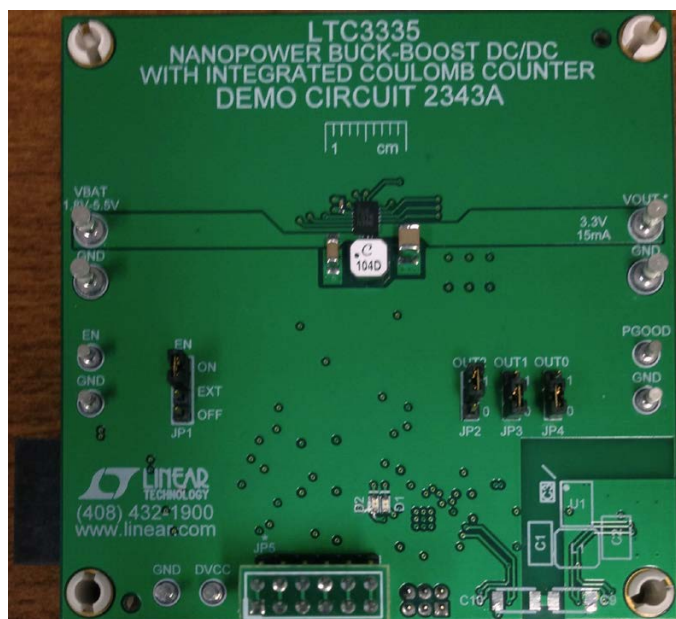
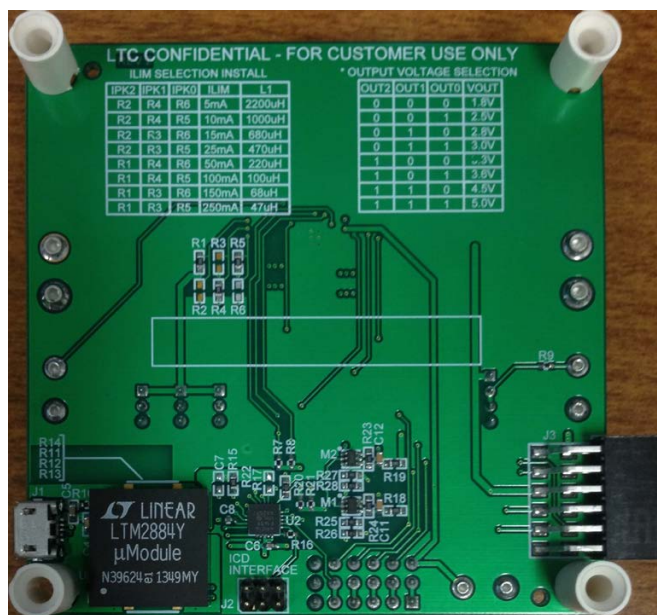

Figure 1. LTC3335 Buck-Boost Efficiency vs Load Current and V_{OUT} for 100mA I_{PEAK} Setting



(a) Top



(b) Bottom

Figure 2. DC2343A Demo Board Pictures

QUICK START PROCEDURE

Refer to Figure 3 for the proper measurement and equipment setup. Use twisted pair leads for the power connections and the LOAD, and connect the equipment with the power supply OFF. Follow the procedure below.

1. To use the DC2343A, the PC must first have the proper software driver and GUI installed. Download the QuikEval software from www.linear.com and install the QuikEval software by running the executable `ltcqev.exe`. Follow the instructions to connect the DC2343A.

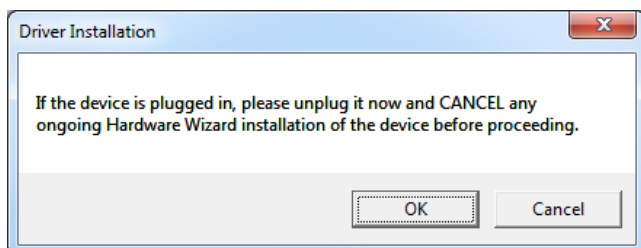

If you fail to unplug the DC2343A, the DC2343A driver will not install! When installation of QuikEval is complete, close the QuikEval program.

2. Move jumper JP5 on the DC2343A from the A-B position to the B-C position to enable the communication from the PIC16 to the LTC3335 device.
3. Reopen QuikEval, and then connect the DC2343A to confirm that the QuikEval software was installed correctly. If properly installed, QuikEval will show the following message:

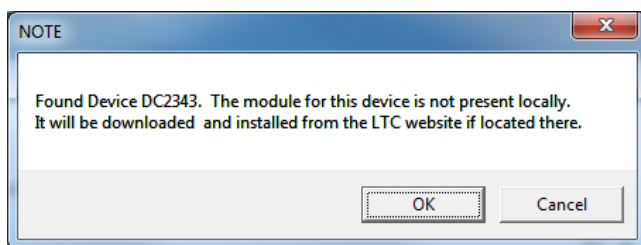

Press OK to download and open the software for the DC2343A. Once the software has been installed, the GUI will launch automatically. Close the QuikEval software, as it is no longer needed for the DC2343A.

4. When the DC2343A is connected to the PC, the PIC16 indicates it is powered through its board status LEDs. These LEDs are also replicated in the GUI, to indicate the state of the PCB.

The green LED flashes quickly when a board is connected but its V_{BAT} input is not powered, and slowly when a board is connected with voltage applied to V_{BAT} . The amber LED turns on when the PIC16 is communicating with the LTC3335.

5. Set PS1 to 5V. The DC2343A will see battery voltage and flash the green LED with a 1 second period. The GUI will then launch the window in Figure 8 to ask for a battery description. Typically the characteristics of an actual battery would be entered. For a quick demonstration of the LTC3335, however, enter these values to simulate a very small battery with power supply PS1:

- a. Battery Capacity (Ah) = 0.02
- b. Battery Coulombs (% Discharged) = 0.00
Battery Alarm (% Discharged) = 80.00

6. Set LOAD1 to 20mA:

The accumulator counter will increment every 49.4 seconds as calculated below:

$$\begin{aligned} \text{Battery Capacity} &= 20\text{mA} \cdot \text{hr} \\ \text{Input Current} &= 6.26\text{mA} \\ \text{Total Counts to 100\%} &= 233 \end{aligned}$$

Secs per Accumulator Increment =

$$\frac{\text{Battery Capacity}}{\text{Input Current}} \cdot \frac{1}{\text{Total Counts to 100\%}} \cdot 3600 \frac{\text{s}}{\text{hr}}$$

$$\text{Secs per Accumulator Increment} = 49.363 \text{ sec}$$

7. The GUI can also show an estimated battery current. In order to demonstrate that GUI feature. Activate the battery current measurement feature described in Figure 12, item 7. In order to implement this feature, the PIC16F1459 on the DC2343A counts edges on the $\overline{\text{IRQ}}$ pin over time, which can then be converted to coulombs per second.

QUICK START PROCEDURE

V_{OUT}/V_{BAT}	Measured (mA)								
	1.8	2	2.5	3	3.5	4	4.5	5	5.5
1.8	20.63	22.13	25.08	27.40	29.23	30.78	32.09	33.25	34.26
2.5	17.68	19.18	22.18	24.55	26.53	28.17	29.62	30.93	32.04
2.8	16.62	18.07	21.06	23.43	25.42	27.11	28.56	29.86	31.07
3	15.94	17.39	20.34	22.71	24.69	26.38	27.88	29.23	30.39
3.3	15.02	16.42	19.37	21.69	23.67	25.42	26.91	28.27	29.48
3.6	14.20	15.55	18.45	20.77	22.76	24.45	26.00	27.35	28.56
4.5	12.14	13.43	16.13	18.36	20.29	21.98	23.48	24.88	26.09
5	11.23	12.46	15.02	17.20	19.10	20.77	22.27	23.67	24.93

Figure 3. Measured Maximum Output Current vs V_{OUT} and V_{BAT} for $I_{PEAK} = 100\text{mA}$, $L1 = 100\mu\text{H}$

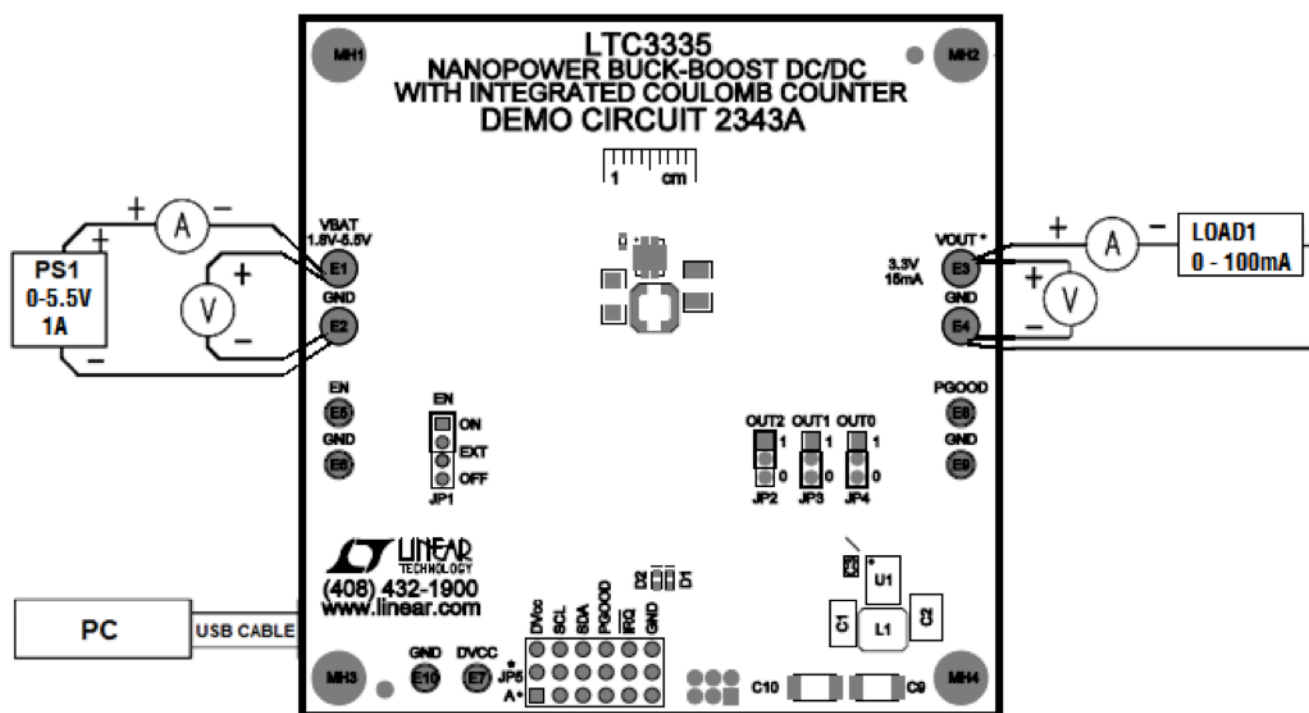

Figure 4. Proper Measurement Equipment Setup

QUICK START PROCEDURE

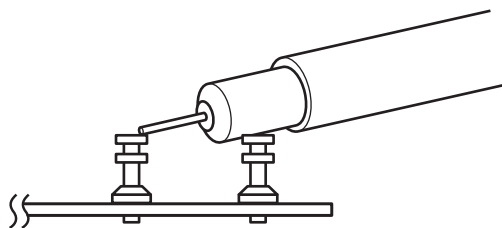

Figure 5. Measuring Input or Output Ripple

USING THE LTC3335 SOFTWARE

The DC2343A GUI consists of five windows:

1. The Control Panel Window displays the components on the DC2343A PCB and their relationship with the user's battery. The other four windows are shown by clicking or double clicking on the controls circled on the control panel in Figure 6.
2. The Battery Selection Window allows the user to specify the battery that they have connected to the DC2343A. This information is necessary for the GUI to properly configure the LTC3335, and interpret the values read from the IC. This window will automatically popup the first time that a battery is attached to the DC2343A.
3. The EN Jumper Window displays the options for JP1 on the DC2343A. The position of this jumper is not important to the operation of the GUI, although communication with the LTC3335 is not possible unless this jumper is in the ON position.
4. The OUT Jumpers Window displays the options for JP2–JP4 on the DC2343A. The position of this jumper is not important to the operation of the GUI. It will only specify the output voltage when the LTC3335 is configured for `HARDWARE_CONTROL` (default).
5. The I_{PEAK} Selection Window configures the GUI so that it will properly interpret the values read from the LTC3335. It is set to the factory configuration of 100mA by default. If a user modifies the I_{PEAK} setting by changing L1 and R1–R6 on the DC2343A, they must reconfigure the PCB through this screen for the GUI to continue interpreting the values read from the LTC3335 properly.

USING THE LTC3335 SOFTWARE

1) Control Panel Window

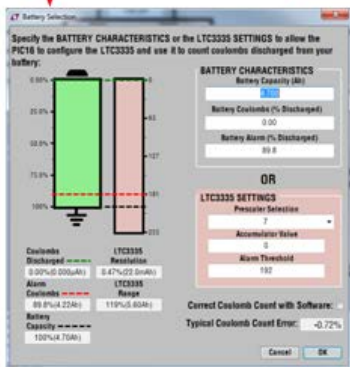
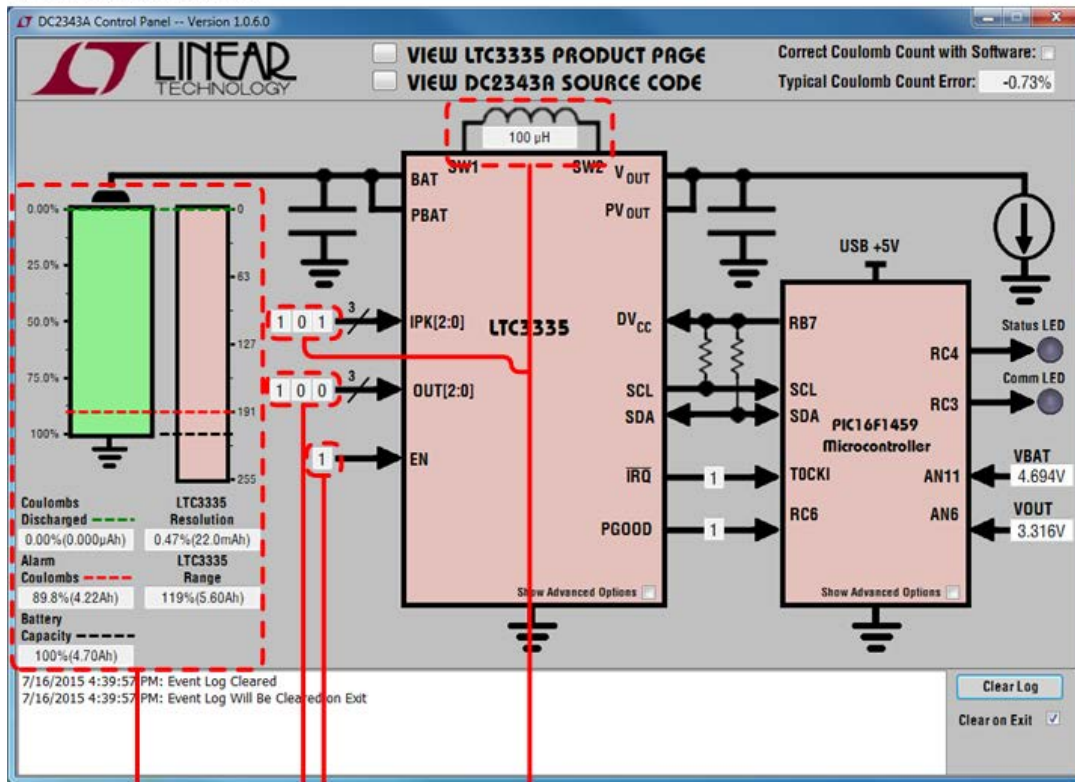

2) Battery Selection Window

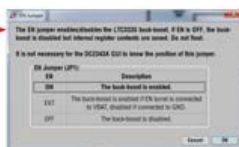

3) EN Jumper Window



4) OUT Jumpers Window

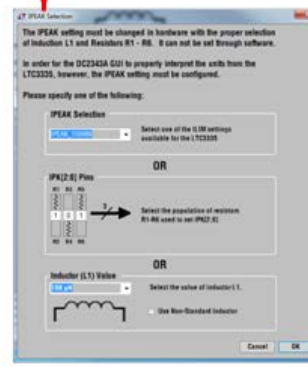

5) IPEAK Selection Window

Figure 6. DC2343A GUI Navigation

USING THE LTC3335 SOFTWARE

The Control Panel Window displays the components on the DC2343A PCB and their relationship with the user's battery. The features of this window are shown in Figure 7.

1. This graphic shows the relationship between the user's battery and the LTC3335 coulomb counter. When the LTC3335 is properly configured, the battery capacity will always be between 128 and 255 counts. The green line represents the accumulator value, the red line represents the alarm value, and the black line represents the battery capacity. These lines can be clicked and dragged to modify the LTC3335 register values.
2. These indicators display the battery characteristics as a % of capacity and in Ah.
3. The indicators display the resolution and range of the LTC3335 coulomb counter for its given I_{PEAK} and prescaler configuration. The range text will be red if the LTC3335 is configured for a range that is less than 100% the battery's capacity. The resolution text will be red if the LTC3335 is not configured for at least 0.78% the battery's capacity per count.
4. These indicators show the values of the LTC3335 inputs for which the GUI has been configured. Clicking these inputs will bring up a window where they can be changed. Only the IPK[2:0] bits affect the operation of the GUI.
5. Checking this box will expose additional controls for the LTC3335. See the control panel advanced mode in Figure 12.
6. The indicators show the status of the PGOOD and \overline{IRQ} outputs from the LTC3335.
7. Checking this box will expose additional controls for the PIC16F1459. See the Control Panel Advanced Mode in Figure 12.
8. GUI Events are recorded in this log, such as battery connection, modification of LTC3335 registers, and changes of the PGOOD and \overline{IRQ} outputs. The log can be maintained after the GUI is exited, to create a record over a long time in which GUI is periodically used to monitor a DC2343A.
9. The PIC16F1459 measurements of the V_{BAT} and V_{OUT} voltages are presented here. Note that these ADC measurements can consume up to 35nA of the battery current, and will occasionally cause the LTC3335 to turn on in order to replace the charge lost from V_{OUT} when the ADC measurement is done.
10. The status LEDs provide information about the DC2343A operation. Their behavior mirrors the LEDs on the DC2343A PCB.
 - The green LED will flash quickly if a DC2343A is not attached or if a battery is not present. It will flash slowly if the DC2343A is attached with a battery in an acceptable range for the DC2343A.
 - The amber LED will flash each time the PIC16F1459 communicates with the LTC3335.
11. The typical error is displayed for the current I_{PEAK} , V_{BAT} , and V_{OUT} conditions of the LTC3335. If the checkbox is selected to correct the coulomb count with software, the accumulator will be adjusted by the typical error to reduce this error. See the Software Coulomb Counter Correction section for information about software error correction.
12. These buttons provide links to the LTC website for information about the LTC3335 IC and the DC2343A software.

USING THE LTC3335 SOFTWARE

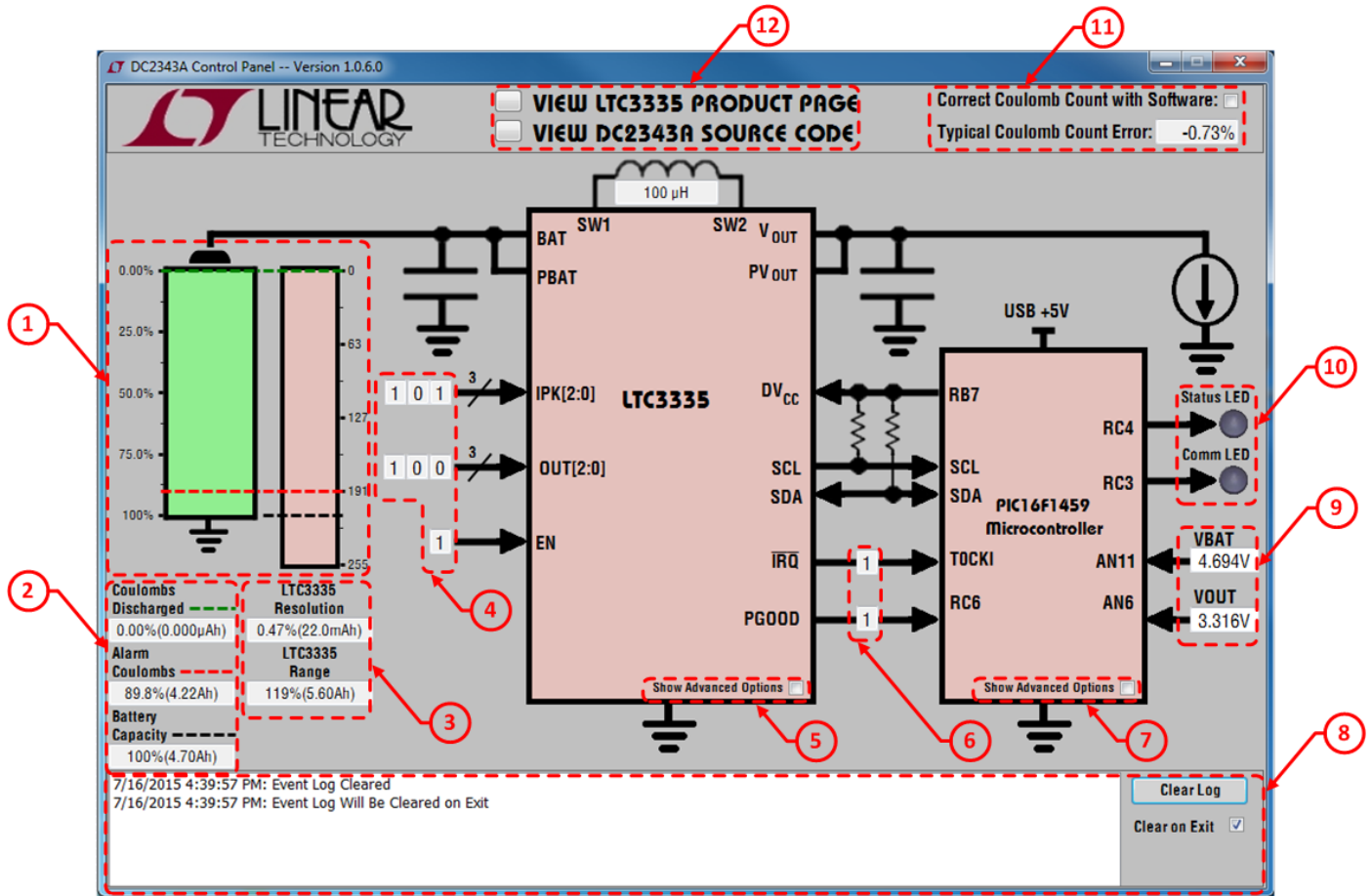

Figure 7. Control Panel Window

USING THE LTC3335 SOFTWARE

The Battery Selection Window allows the user to specify the battery that they have connected to the DC2343A. This information is necessary for the GUI to properly configure the LTC3335, and interpret the values read from the IC. This window will automatically popup the first time that a battery is attached to the DC2343A. Note that none of the values in this value will be written to the LTC3335 until the OK button is pressed, allowing experimentation by the user to see the relationship between their battery characteristics and the LTC3335 settings. The features of this window are shown in Figure 8.

1. This graphic shows the relationship between the user's battery and the LTC3335 coulomb counter. When the LTC3335 is properly configured, the battery capacity will always be between 128 and 255 counts. The green line represents the accumulator value, the red line represents the alarm value, and the black line represents the battery capacity. These lines can be clicked and dragged to modify the LTC3335 register values.
2. These indicators display the battery characteristics as a % of capacity and in Ah.
3. The indicators display the resolution and range of the LTC3335 coulomb counter for its given I_{PEAK} and Prescaler configuration. This range text will be red if the LTC3335 is configured for a range that is less than 100% the battery's capacity. This resolution text will be red if the LTC3335 is not configured for at least 0.78% the battery's capacity per count.
4. The battery characteristics are the simplest method of configuring the LTC3335. Enter the battery capacity in Ah to set the LTC3335 prescaler to the value that provides enough range for that battery while maintaining the highest possible resolution. Enter the discharged capacity and alarm threshold as a % of battery capacity.
5. Alternatively, the LTC3335 prescaler, accumulator, and alarm values can be set directly. The battery characteristics will be updated to show the physical meaning of the LTC3335 units.
6. The typical error is displayed for the current I_{PEAK} , V_{BAT} , and V_{OUT} conditions of the LTC3335. If the checkbox is selected to correct the coulomb count with software, the accumulator will be adjusted by the typical error to reduce this error. See the Software Coulomb Counter Correction section for information about software error correction.
7. Press the OK button to write the LTC3335 configuration selected in this window to the DC2343A and return to the control panel. Press cancel to return to the control panel without modifying the DC2343A configuration.

USING THE LTC3335 SOFTWARE

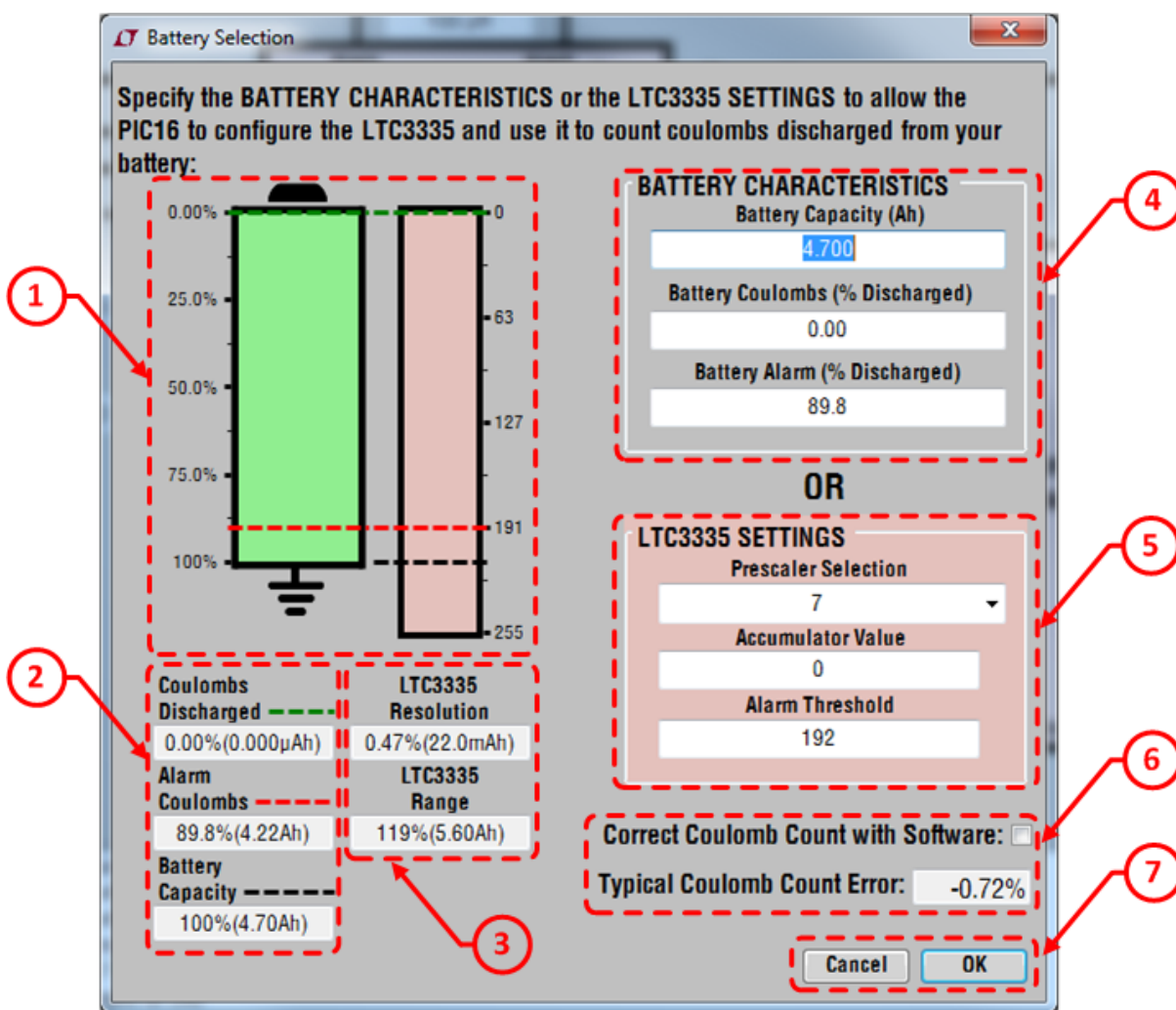

Figure 8. Battery Selection Window

USING THE LTC3335 SOFTWARE

The EN Jumper Window displays the options for JP1 on the DC2343A. The position of this jumper is not important to the operation of the GUI, although communication with the LTC3335 is not possible unless this jumper is in the ON position. The features of this window are shown in Figure 9.

1. Click on one of the three options (ON, EXT, or OFF) to inform the GUI of the position of this jumper. Although this selection is displayed in the GUI, it is not used by any calculations and is unimportant to GUI operation.
2. Press the OK button to write the EN jumper position selected in this window to the DC2343A and return to the control panel. Press Cancel to return to the control panel without modifying the DC2343A configuration.

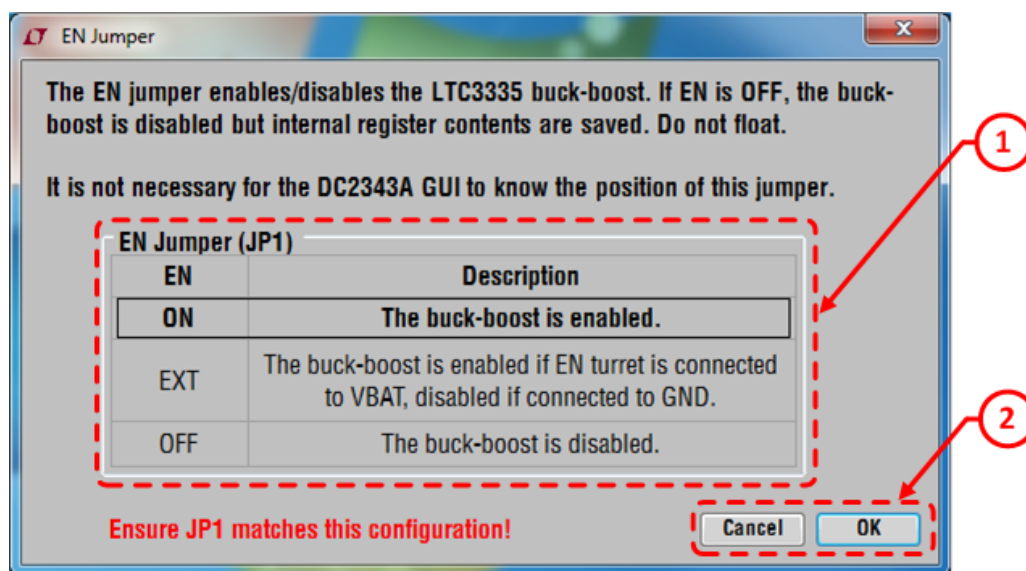

Figure 9. EN Jumper Window

USING THE LTC3335 SOFTWARE

The OUT Jumpers Window displays the options for JP2 – JP4 on the DC2343A. The position of these jumpers are not important to the operation of the GUI. It will only specify the output voltage when the LTC3335 is configured for HARDWARE_CONTROL (default). The features of this window are shown in Figure 10.

1. Click on one of the eight options to inform the GUI of the position of the jumpers specify the output voltage when the LTC3335 is configured for HARDWARE_CONTROL. Although this selection is displayed in the GUI, it is not used by any calculations and is unimportant to GUI operation.
2. Press the OK button to write the OUT jumper positions selected in this window to the DC2343A and return to the control panel. Press Cancel to return to the control panel without modifying the DC2343A configuration.

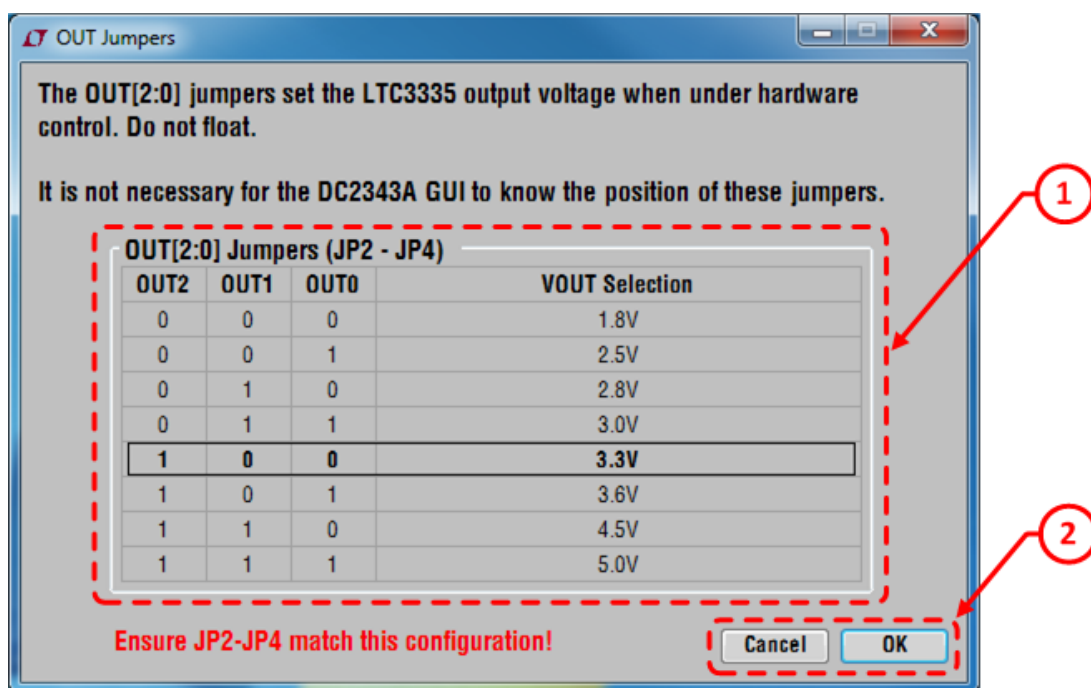

Figure 10. OUT Jumpers Window

USING THE LTC3335 SOFTWARE

The I_{PEAK} Selection Window configures the GUI so that it will properly interpret the values read from the LTC3335. It is set to the factory configuration (100mA) by default. If a user modifies the I_{PEAK} setting by changing L1 and R1 – R6 on the DC2343A, they must reconfigure the PCB through this screen for the GUI to interpret the values read from the LTC3335. The features of this window are shown in Figure 11.

1. Select one of the eight options to inform the GUI of the population of the resistors which configure the I_{PEAK} setting of the LTC3335. The other controls on this window will update to show the proper resistors and inductor population for the selected I_{PEAK} setting.

2. Double click the resistors to inform the GUI which are populated on the DC2343A. The I_{PEAK} setting corresponding to the selected resistors will be displayed as well as the corresponding inductor value.
3. Select one of the inductors to inform the GUI which value is populated on the DC2343A. The of the population of the resistors which configure the I_{PEAK} setting of the LTC3335. The I_{PEAK} setting corresponding to the inductor will be displayed as well as the corresponding resistor population.
4. Press the OK button to write the I_{PEAK} configuration selected in this window to the DC2343A and return to the control panel. Press cancel to return to the control panel without modifying the DC2343A configuration.

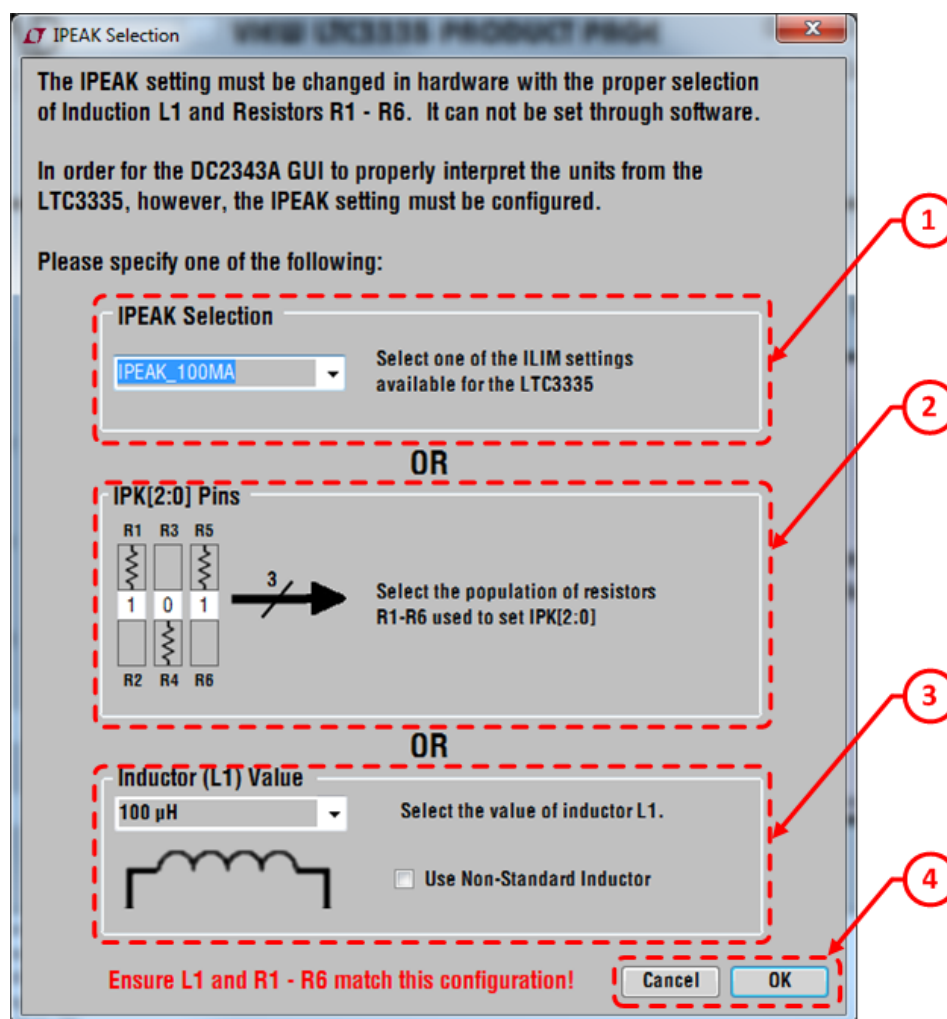

Figure 11. I_{PEAK} Selection Window

USING THE LTC3335 SOFTWARE

When the Show Advanced Options checkbox is selected for the LTC3335 and PIC16F1459 on the control panel, several additional controls are exposed to the user. These controls are in Figure 12.

1. The estimated battery current is displayed when the battery current estimate button is turned on with the button in item 7.
2. The registers in the LTC3335 can be written and read directly with these input fields.
3. These checkboxes display which alarms are currently active in the LTC3335. If an alarm is present, the clear alarm button will allow it to be cleared if the alarm conditions are no longer present and the proper registers have been reset.
4. The counter test can be turned on and off in this field, with the number of \overline{IRQ} edges per seconds displayed below.
5. The serial number and firmware revision of the PIC16F1459 are displayed in these fields.
6. The rate at which the GUI polls the LTC3335 is controlled by this dropdown box. A special method of polling is available where the Accumulator is only read following a falling edge on the \overline{INT} pin. When using this mode, the alarm setting is not available to the user as it is always set by the GUI to be one less than the current accumulator value.
7. This button will turn on the counter test function, and use the PIC16F1459 to convert the number of \overline{IRQ} edges per second into a battery current estimate.

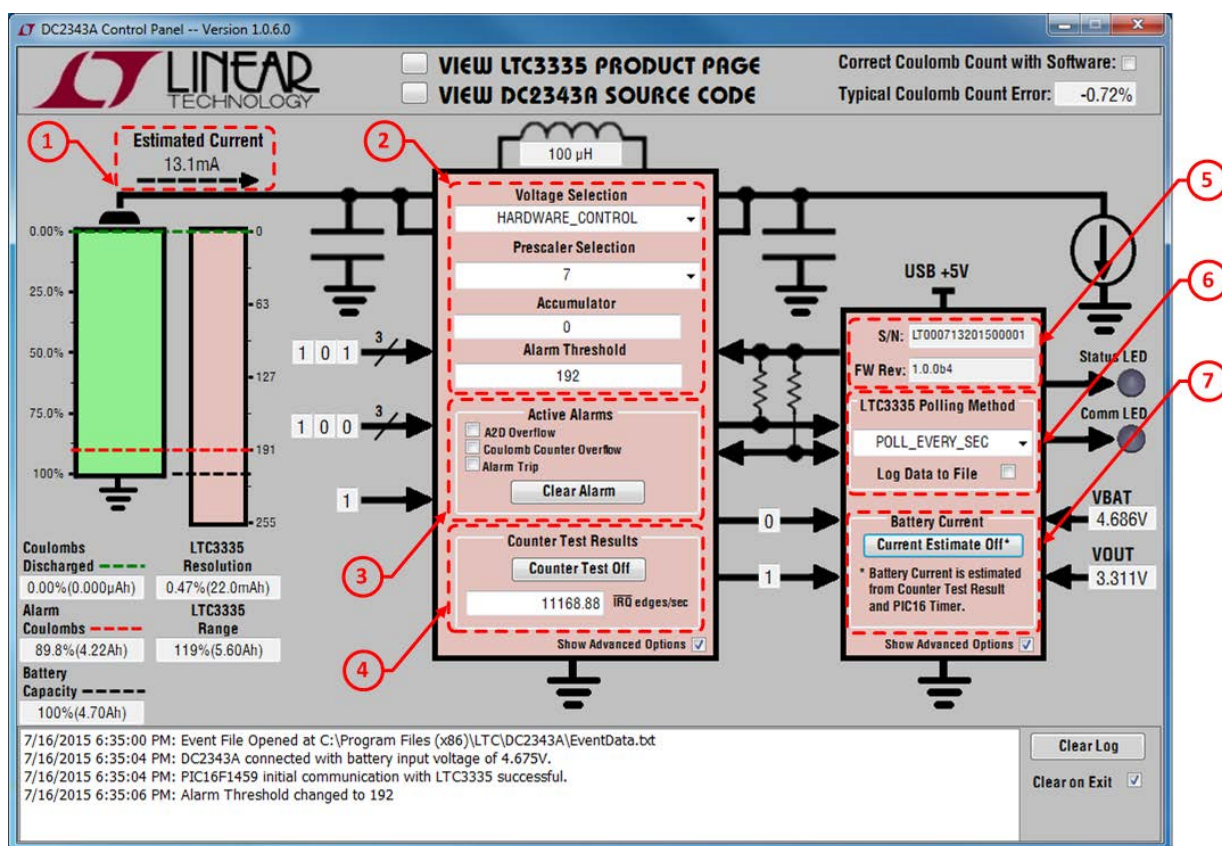

Figure 12. Control Panel Window—Advanced Options

SOFTWARE COULOMB COUNTER CORRECTION

The LTC3335 accuracy is impressive when configured for high values of I_{PEAK} . When configured with low values of I_{PEAK} , however, there can be up to 40% error. The DC2343A GUI contains algorithms to correct for this error based upon the I_{PEAK} , V_{OUT} , and V_{BAT} conditions of the DC2343A. Although the GUI uses the sampled V_{OUT} and V_{BAT} values for correction, most applications could use fixed values for V_{OUT} and V_{BAT} if they are expected to be relatively constant.

The standard population of the DC2343A is configured for an I_{PEAK} value of 100mA. The typical coulomb counter error for this board is shown in Figure 13. As the LTC3335 is already accurate within $\pm 2\%$ in this configuration, there is little value to software correction. Software correction is also very difficult as the actual error can vary a lot about the average error.

The typical coulomb counter error for the DC2343A re-configured for an I_{PEAK} of 5mA is shown in Figure 14. In this configuration the LTC3335 can have significant errors over 30%. Since the error is predictable and the actual error varies little of the average error, the GUI is able to apply a correction factor to the LTC3335 accumulator to produce a more accurate coulomb count.

When software correction of the coulomb count is not enabled in the battery selection window, the accumulator is simply multiplied by the expected resolution for the LTC3335 I_{PEAK} and prescaler values. If software correction

of the coulomb count is enabled in the battery selection window, the expected resolution is adjusted by the typical error so that the battery capacity, discharge, and alarm values can be more accurate translated to values in the LTC3335 accumulator. Figure 15 shows the effect of enabling the software coulomb count correction in the battery selection window. Since the LTC3335 is expected to undercount 26.69% under the starting conditions, the alarm and capacity values are decreased to reflect the additional coulombs represented by each count in the LTC3335 accumulator.

Clicking OK in the battery selection window will return the GUI to the control panel. When using the software correction of the coulomb count in the control panel, the error correction is continuously updated to reflect the different error at the different battery conditions. In addition, the quiescent current drawn by the LTC3335 is taken into account by the GUI. For this reason, the coulomb count in the battery graphic can become unsynchronized with the accumulator value in the LTC3335 as shown in Figure 16. The worst case of this would occur if the LTC3335 were left for a very long time with no load as the battery would eventually become 100% discharged due to quiescent losses although the accumulator would remain at 0. This worst case scenario, however, would take several years to complete with most batteries. An example of a discharge with and without software coulomb count correction is shown in Figure 17.

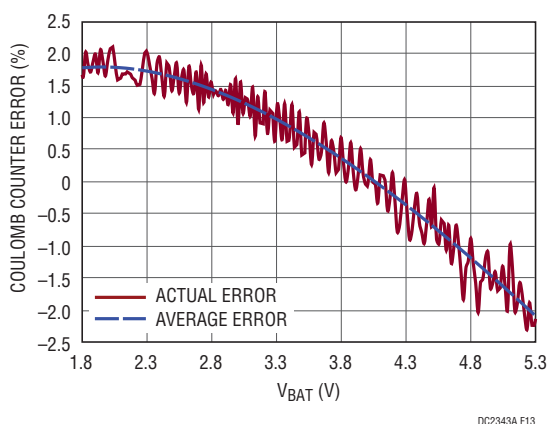

Figure 13. Typical DC2343A Coulomb Counter Error with $I_{PEAK} = 100\text{mA}$, $V_{OUT} = 3.3\text{V}$, $\text{Temp} = 25^\circ\text{C}$

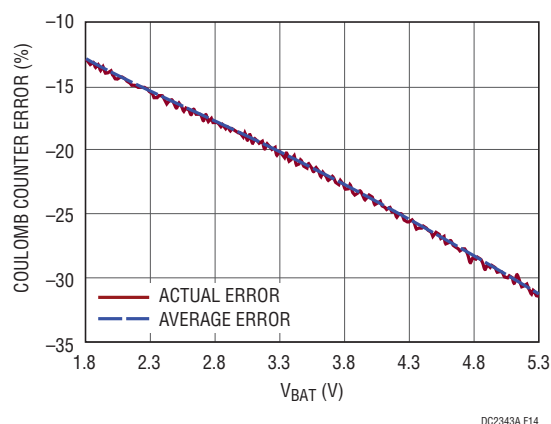

Figure 14. Typical DC2343A Coulomb Counter Error with $I_{PEAK} = 5\text{mA}$, $V_{OUT} = 3.3\text{V}$, $\text{Temp} = 25^\circ\text{C}$

SOFTWARE COULOMB COUNTER CORRECTION

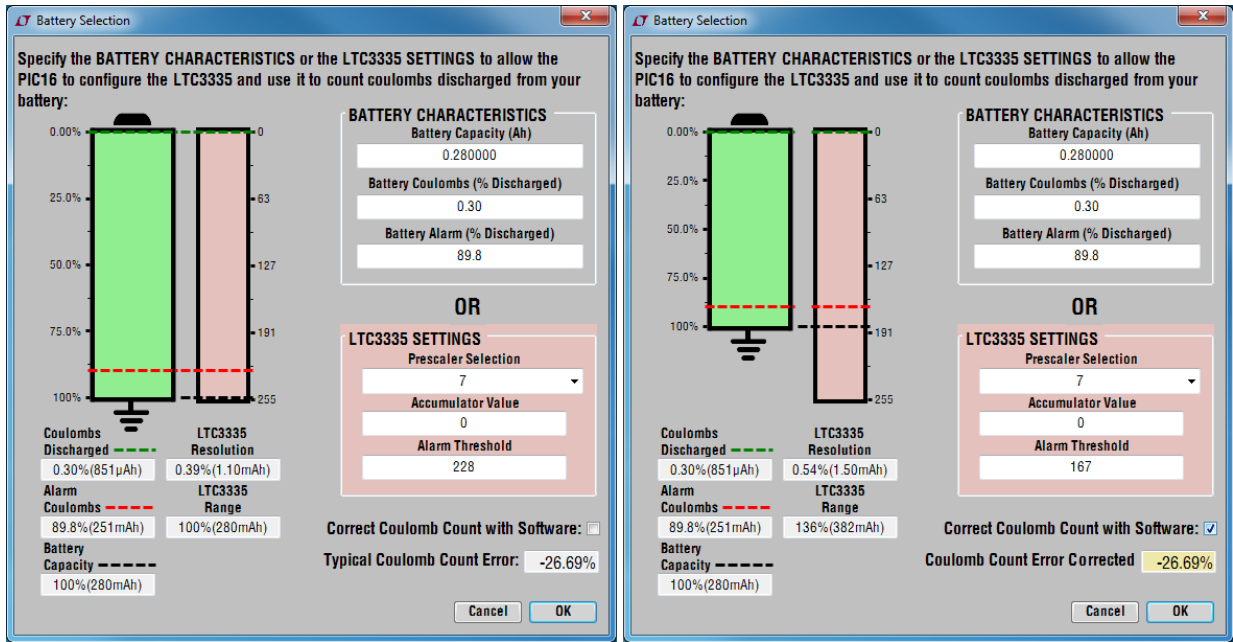

Figure 15. Effect of Software Coulomb Count Correction in Battery Selection Window

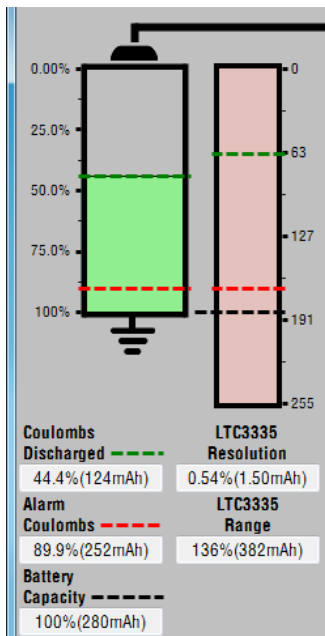

Figure 16. Software Correction Control Panel

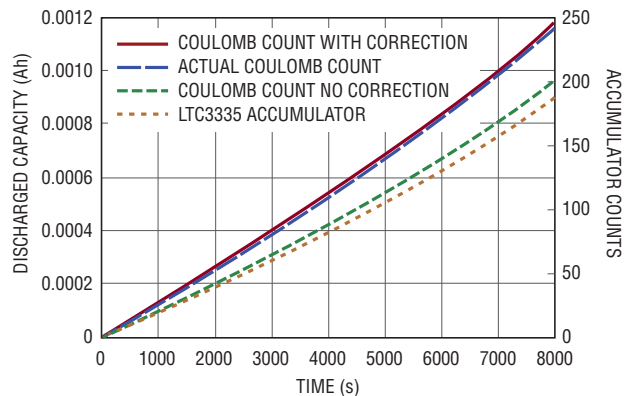

Figure 17. Effect of Software Coulomb Count Correction for Discharge with 5mA IPEAK

DEMO MANUAL DC2343A

PARTS LIST

ITEM	QTY	REFERENCE	PART DESCRIPTION	MANUFACTURER/PART NUMBER
Required Circuit Components				
1	1	C1	CAP, CHIP, X5R, 22 μ F, 20%, 6.3V, 1206	SAMSUNG, CL31A226MQHNNNE
2	1	C2	CAP, CHIP, X5R, 150 μ F, 20%, 6.3V, 1210	SAMSUNG, CL32A157MQVNNNE
3	1	C3	CAP, CHIP, X5R, 1000pF, \pm 10%, 50V, 0402	TDK, C1005X5R1H102K
4	2	C4, C5	CAP, CHIP, X5R, 10 μ F, \pm 20%, 6.3V, 0603	MURATA, GRM188R60J106ME47D
5	2	C6	CAP, CHIP, X7R, 0.1 μ F, \pm 10%, 50V, 0402	TDK, C1005X7R1H104KT
6	1	C7*	*RES, CHIP, 301,1/10W,1%,0603	VISHAY, CRCW0603301RFKEA
7	1	C8	CAP, CHIP, X5R, 0.47 μ F, \pm 10%, 16V, 0402	TDK, C1005X5R1C474K
8	2	C11, C12	CAP, CHIP, X5R, 1 μ F, \pm 10%, 25V, 0402	MURATA, GRM155R61E105KA12
9	1	D1	LED, YELLOW ORANGE CLEAR, 0603, SMD	LITE-ON, LTST-C190KFKT
10	1	D2	LED, GREEN CLEAR, 0603, SMD	LITE-ON, LTST-C190KGKT
11	1	L1	IND, SMT, 100 μ H, 0.600 Ω , 310mA, 4.9mm \times 4.9mm \times 3mm	COILCRAFT, LPS5030-104MRB
12	2	M1, M2	MOSFET, N/P-CH, LOW-THRESHOLD, 20V, 500mA, SC70-6	VISHAY, Si1553CDL
13	3	R1, R4, R5	RES, CHIP, 0 Ω JUMPER, 1/10W, 0603	VISHAY, CRCW06030000Z0ED
14	3	R7, R8, R16	RES, CHIP, 10k Ω , \pm 5%, 1/16W, 0402	VISHAY, CRCW040210K0JNED
15	1	R9	RES, CHIP, 1k Ω , \pm 5%, 1/16W, 0402	VISHAY, CRCW04021K00JNED
16	1	R10	RES, CHIP, 1 Ω , \pm 5%, 1/16W, 0402	VISHAY, CRCW04021R00JNED
17	1	R15	RES,CHIP, 301,1/10W,1%,0603	VISHAY, CRCW0603301RFKEA
18	1	R17	RES,CHIP, 10M,1/10W,5%,0603	VISHAY, CRCW060310M0JNEA
19	2	R18, R19	RES,CHIP, 100,1/10W,1%,0603	VISHAY, CRCW0603100RFKEA
20	2	R20, R21	RES, CHIP, 2k Ω , \pm 5%, 1/16W, 0402	VISHAY, CRCW04022K00JNED
21	2	R23, R24	RES,CHIP, 49.9k,1/10W,1%,0603	VISHAY, CRCW060349K9FKEA
22	2	R25, R27	RES,CHIP, 10.0k,1/10W,1%,0603	VISHAY, CRCW060310K0FKEA
23	2	R26, R28	RES,CHIP, 28.7k,1/10W,1%,0603	VISHAY, CRCW060328K7FKEA
24	1	U1	IC, SMT, NANOPOWER BUCK-BOOST WITH COULOMB COUNTER, 3mm \times 4mm, QFN-20	LINEAR TECH., LTC3335EUDC#PBF
25	1	U2	8-BIT MICROCONTROLLER WITH XLP USB, 4mm \times 4mm, QFN-20	MICROCHIP, PIC16F1459-I/ML
26	1	U3	μ MODULE, ISOLATED USB TRANCEIVER WITH POWER, 15mm \times 15mm \times 5mm, BGA44	LINEAR TECH., LTM2884CY#PBF
Additional Demo Board Circuit Components				
27	0	C9 (OPT), C10 (OPT)	CAP., X7R, 470PF, 250VAC, 10%, 1808	MURATA, GA342QR7GF471KW01L
28	0	C7 (OPT)	CAP, CHIP, X5R, 10 μ F, \pm 20%, 6.3V, 0603	MURATA, GRM188R60J106ME47D
29	0	R2-OPT, R3-OPT, R6-OPT	RES, CHIP, 0 Ω JUMPER, 1/10W, 0603	VISHAY, CRCW06030000Z0ED
30	0	R11, R12, R13, R14 (OPT)	RES, CHIP, 0 Ω , 2512, 1.0W	VISHAY, CRCW25120000Z0EG
Hardware: For Demo Board Only				
31	4	E1, E2, E3, E4	TURRET, 0.09 DIA	MILL-MAX, 2501-2-00-80-00-00-07-0
32	6	E5, E6, E7, E8, E9, E10	TURRET, 0.061 DIA	MILL-MAX, 2308-2-00-80-00-00-07-0
33	1	JP1	HEADER, 2MM, 1 \times 4 POS	SAMTEC, TMM-104-02-L-S
34	3	JP2, JP3, JP4	HEADER, 2MM, 1 \times 3 POS	SAMTEC, TMM-103-02-L-S
35	4	JP1, JP2, JP3, JP4	SHUNT, 2MM	SAMTEC, 2SN-KB-G
36	1	J1	USB 2.0, MICRO-B, RECEPTACLE, RT, SMT	TE CONNECTIVITY, 1981568-1

PARTS LIST

ITEM	QTY	REFERENCE	PART DESCRIPTION	MANUFACTURER/PART NUMBER
37	1	J2	HEADER, 2x3, 2mm, THT, DUAL PIN	WURTH, 62000621121
38	1	J3	HEADER, 2.54mm, 12-PIN, DUST HEADER, 2x6, KEY AT PIN #5	SAMTEC, SMH-106-02-L-D-05
39	1	JP5	HEADER UNSHROUDED, 3x6, THRU-HOLE, VERT, 2.54mm	SAMTEC, TSW-106-07-L-T
40	1	JP5 (MATE)	EMBEDDED μ C CONNECT JUMPER (JP5 MATE)	LINEAR TECH, DC2343A-1-ASSY1
41	4		STAND-OFF, NYLON (SNAP ON), 0.375" TALL	KEYSTONE, 8832 (SNAP ON)

SCHEMATIC DIAGRAM

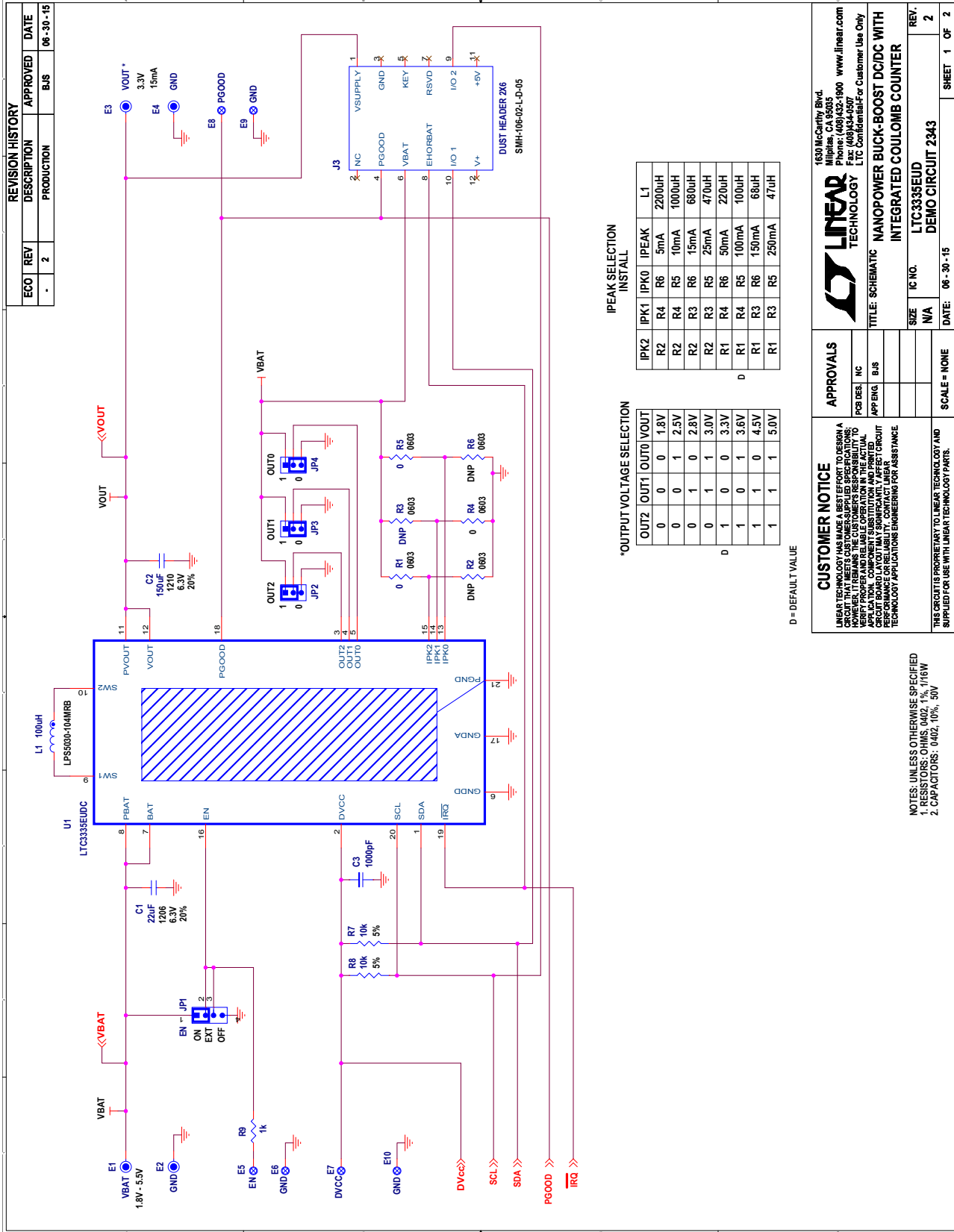

Figure 18. DC2343A Demo Circuit Schematic

SCHEMATIC DIAGRAM

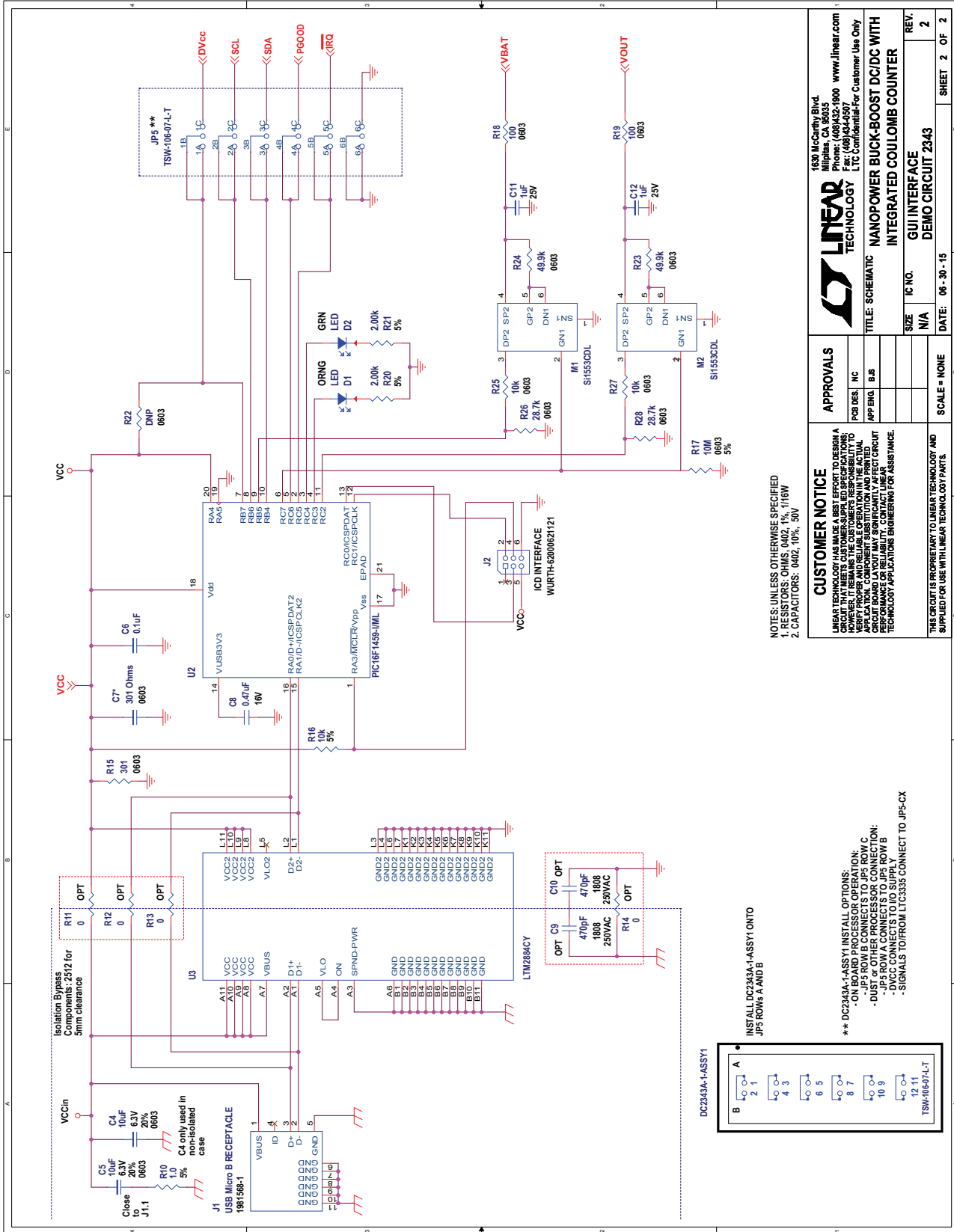

Figure 19. DC2343A Demo Circuit Schematic

DEMO MANUAL DC2343A

DEMONSTRATION BOARD IMPORTANT NOTICE

Linear Technology Corporation (LTC) provides the enclosed product(s) under the following **AS IS** conditions:

This demonstration board (DEMO BOARD) kit being sold or provided by Linear Technology is intended for use for **ENGINEERING DEVELOPMENT OR EVALUATION PURPOSES ONLY** and is not provided by LTC for commercial use. As such, the DEMO BOARD herein may not be complete in terms of required design-, marketing-, and/or manufacturing-related protective considerations, including but not limited to product safety measures typically found in finished commercial goods. As a prototype, this product does not fall within the scope of the European Union directive on electromagnetic compatibility and therefore may or may not meet the technical requirements of the directive, or other regulations.

If this evaluation kit does not meet the specifications recited in the DEMO BOARD manual the kit may be returned within 30 days from the date of delivery for a full refund. **THE FOREGOING WARRANTY IS THE EXCLUSIVE WARRANTY MADE BY THE SELLER TO BUYER AND IS IN LIEU OF ALL OTHER WARRANTIES, EXPRESSED, IMPLIED, OR STATUTORY, INCLUDING ANY WARRANTY OF MERCHANTABILITY OR FITNESS FOR ANY PARTICULAR PURPOSE. EXCEPT TO THE EXTENT OF THIS INDEMNITY, NEITHER PARTY SHALL BE LIABLE TO THE OTHER FOR ANY INDIRECT, SPECIAL, INCIDENTAL, OR CONSEQUENTIAL DAMAGES.**

The user assumes all responsibility and liability for proper and safe handling of the goods. Further, the user releases LTC from all claims arising from the handling or use of the goods. Due to the open construction of the product, it is the user's responsibility to take any and all appropriate precautions with regard to electrostatic discharge. Also be aware that the products herein may not be regulatory compliant or agency certified (FCC, UL, CE, etc.).

No License is granted under any patent right or other intellectual property whatsoever. **LTC assumes no liability for applications assistance, customer product design, software performance, or infringement of patents or any other intellectual property rights of any kind.**

LTC currently services a variety of customers for products around the world, and therefore this transaction **is not exclusive**.

Please read the DEMO BOARD manual prior to handling the product. Persons handling this product must have electronics training and observe good laboratory practice standards. **Common sense is encouraged.**

This notice contains important safety information about temperatures and voltages. For further safety concerns, please contact a LTC application engineer.

Mailing Address:

Linear Technology
1630 McCarthy Blvd.
Milpitas, CA 95035

Copyright © 2004, Linear Technology Corporation