

DETAILS

Product Number	F14534_ANGELETTE-WW
Family	Angelette
Type	Reflector
Color	metal
Diameter	110 mm
Height	57,3 mm
Style	round
Optic Material	PC
Holder Material	
Fastening	socket
Status	production ready
ROHS Compliant	Yes
Date Updated	8/02/2017



OPTICAL PROPERTIES

LED	Viewing Angle	Light Beam	Efficiency	cd/lm	Connector
V22 Gen6	63 deg	Very Wide	89 %	0.920	IDEAL: 50-2204-CT + 50-2100AN
V13 Gen7	60 deg	Very Wide	89 %	1.100	TE: 2213254-2 + OPTIC CLIP Z50 TYPE1 2213194-1
V22 Gen7	sim: 55	Very Wide	sim: 94 %	sim: 1.341	IDEAL: 50-2204-CT + 50-2100AN
V13 Gen7	sim: 62	Very Wide	sim: 90 %	sim: 1.070	IDEAL: 50-2103CT + 50-2100AN
CLL03x/CLU03x	61 deg	Very Wide	89 %	1.100	TE: 2213254-2 + OPTIC CLIP Z50 TYPE1 2213194-1
CLL03x/CLU03x	59 deg	Very Wide	89 %	1.100	IDEAL: 50-2103CT + 50-2100AN
CLU730/731	57 deg	Very Wide	89 %	1.100	IDEAL: 50-2204-CT + 50-2100AN
LUXEON CoB 1208	61 deg	Very Wide	89 %	1.100	IDEAL: 50-2100SH + 50-2100AN
LUXEON CoB 1208	61 deg	Very Wide	89 %	1.100	TE: 2213130-2 + OPTIC CLIP Z50 TYPE1 2213194-1
LUXEON CoB 1208	63 deg	Very Wide	89 %	0.970	IDEAL: 50-2204-CT + 50-2100AN
LUXEON CoB 1216	63 deg	Very Wide	89 %	0.920	IDEAL: 50-2204-CT + 50-2100AN
COB L-Type (LES 11)	51 deg	Very Wide	88 %	1.200	IDEAL: 50-2100NC + 50-2100AN
COB L-Type (LES 11)	53 deg	Very Wide	89 %	1.200	TE: 2213382-2 + OPTIC CLIP Z50 TYPE1 2213194-1
COB J-Type	60 deg	Very Wide	89 %	1.100	IDEAL: 50-2103NC + 50-2100AN
PrevaLED Core Z4 LES19	62 deg	Very Wide	89 %	1.000	TE: OPTIC CLIP Z50 TYPE1 2213194-1
Soleriq S19	63 deg	Very Wide	89 %	1.000	TE: 2213407-2 + OPTIC CLIP Z50 TYPE1 2213194-1
Soleriq S13 Gen2	56 deg	Very Wide	89 %	1.100	TE: 2213254-2 + OPTIC CLIP Z50 TYPE1 2213194-1
Soleriq S13 Gen2	56 deg	Very Wide	88 %	1.100	IDEAL: 50-2103CT + 50-2100AN
Fortimo SLM G5 LES 15 Standard	62 deg	Very Wide	89 %	1.000	TE: OPTIC CLIP Z50 TYPE1 2213194-1
LC040C	53 deg	Very Wide	89 %	1.200	TE: 2213382-2 + OPTIC CLIP Z50 TYPE1 2213194-1
AC Zhaga COB	70 deg	Very Wide	89 %	0.850	Optosource: SEHSMJD-A
MJT COB LES 14.5	64 deg	Very Wide	89 %	1.000	TE: 2213254-2 + OPTIC CLIP Z50 TYPE1 2213194-1
SLE G6 LES15	sim: 48	Very Wide	sim: 89 %	sim: 1.300	TE: 2213254-2 + OPTIC CLIP Z50 TYPE1 2213194-1
SLE G6 LES17	sim: 52	Very Wide	sim: 86 %	sim: 1.240	TE: 2213254-2 + OPTIC CLIP Z50 TYPE1 2213194-1
WU-M-484	56 deg	Very Wide	89 %	1.100	TE: OPTIC CLIP Z50 TYPE1 2213194-1



PRODUCT DATASHEET

Angelette series

last update 8/2/2017

OPTICAL PROPERTIES

LED	Viewing Angle	Light Beam	Effi- ciency	cd/lm	Connector
-----	------------------	---------------	-----------------	-------	-----------

NOTE:
 Customer may add additional light modifying parts to Angelette family(excluding the plain versions):
 Minumum height of additional part is 1.5mm and maximum is 2.2mm. Diameter is 105.9mm±0.3

57.26 + Basepart

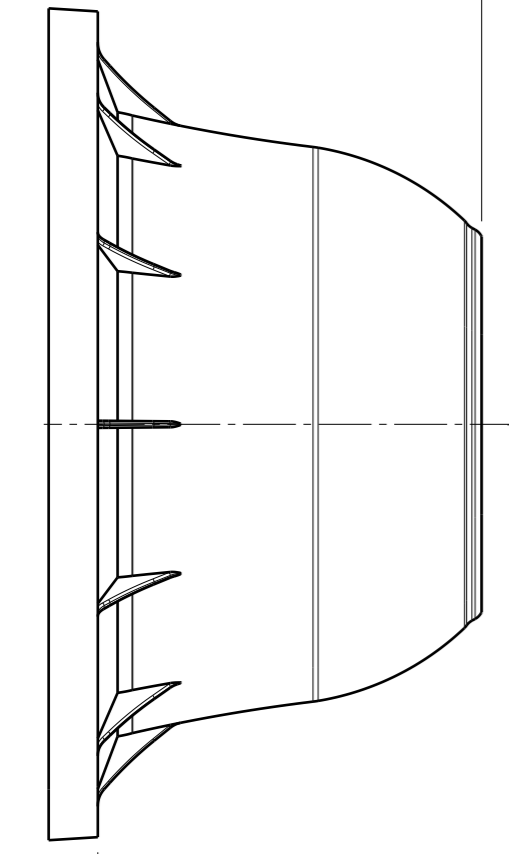

6.5

Front view

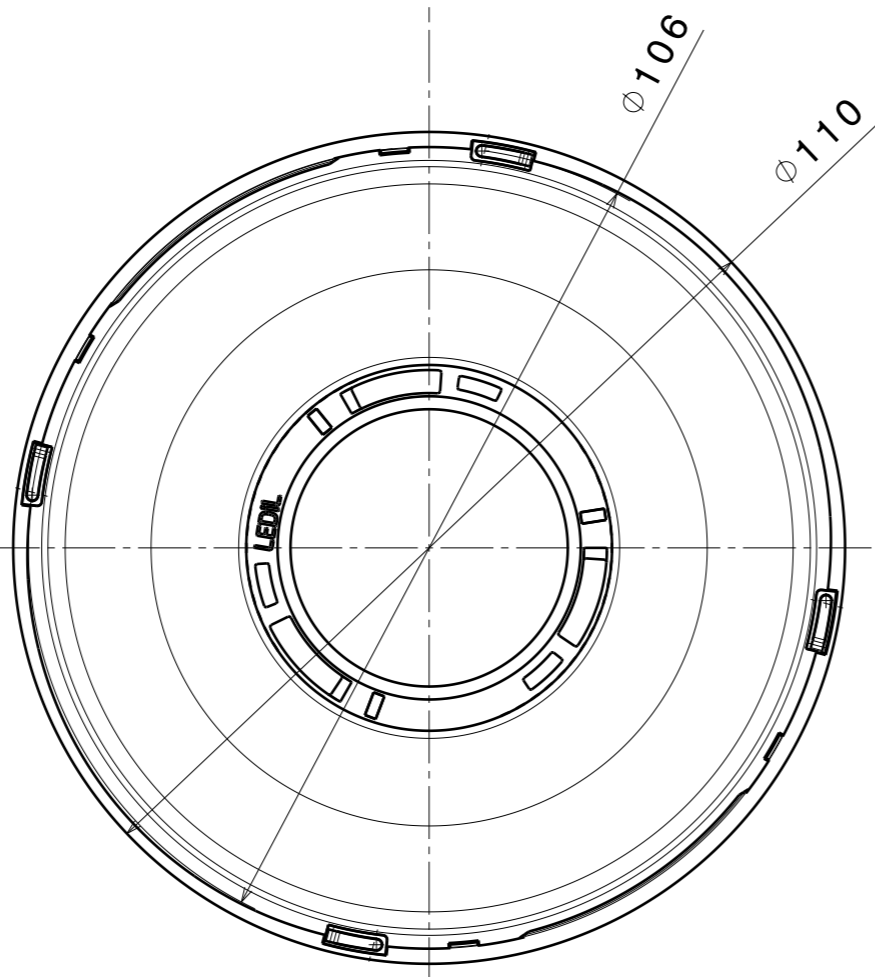

Top view

∅106
∅110

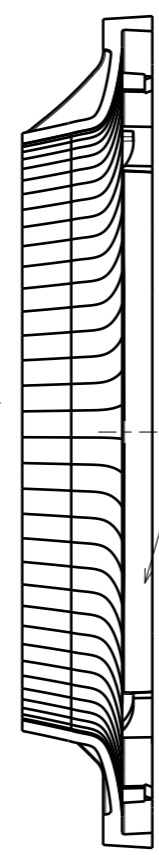

Section view

Section view

ANGELETTE-WW

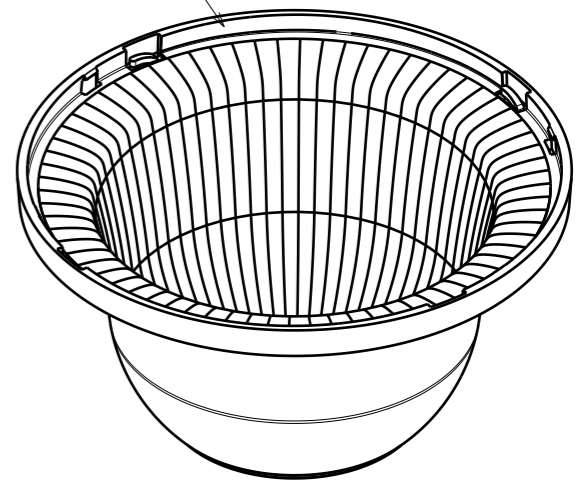

ANGELETTE-WW-PLAIN

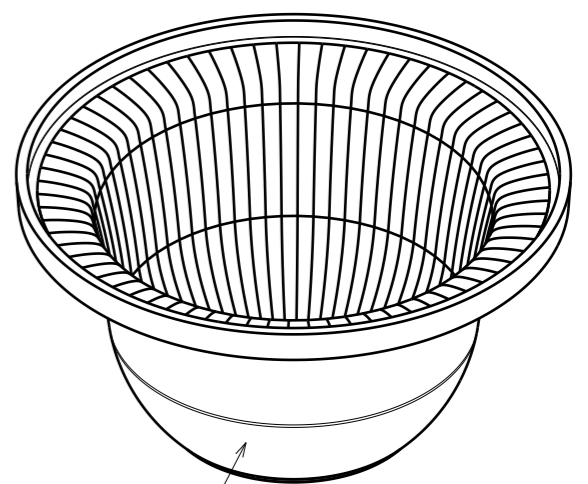

Tolerances if not otherwise shown
 According to DIN ISO 2768-1
 Linear measures:
 up to 30mm class M, otherwise class C
 According to DIN ISO 2768-2
 Form and position: class L

LEDiL Ledil Oy
 Salorankatu 10
 FIN 24240 SALO
 Finland

THIRD ANGLE PROJECTION:

DRAWING TITLE
Datasheet_ANGELETTE-WW

This drawing is the property
 of LEDiL Oy. It may not be
 reproduced, copied or
 communicated without a written
 agreement with LEDiL Oy.

SIZE **A3** PART NUMBER **ANGELETTE-WW**
ANGELETTE-WW-PLAIN

SCALE **1:1** WEIGHT SHEET **1/1**

Luminaire: Ledil F14534_ANGELETTE-WW_(V22+IDEAL)
Lamps: 1 x Bridgelux_V22_(BXRE30E6500H-Y2)_+50-2204CT_+_50-2100AN_1193.54lm@250mA_CCT=3000K_P=8.0988W_I=0.25A

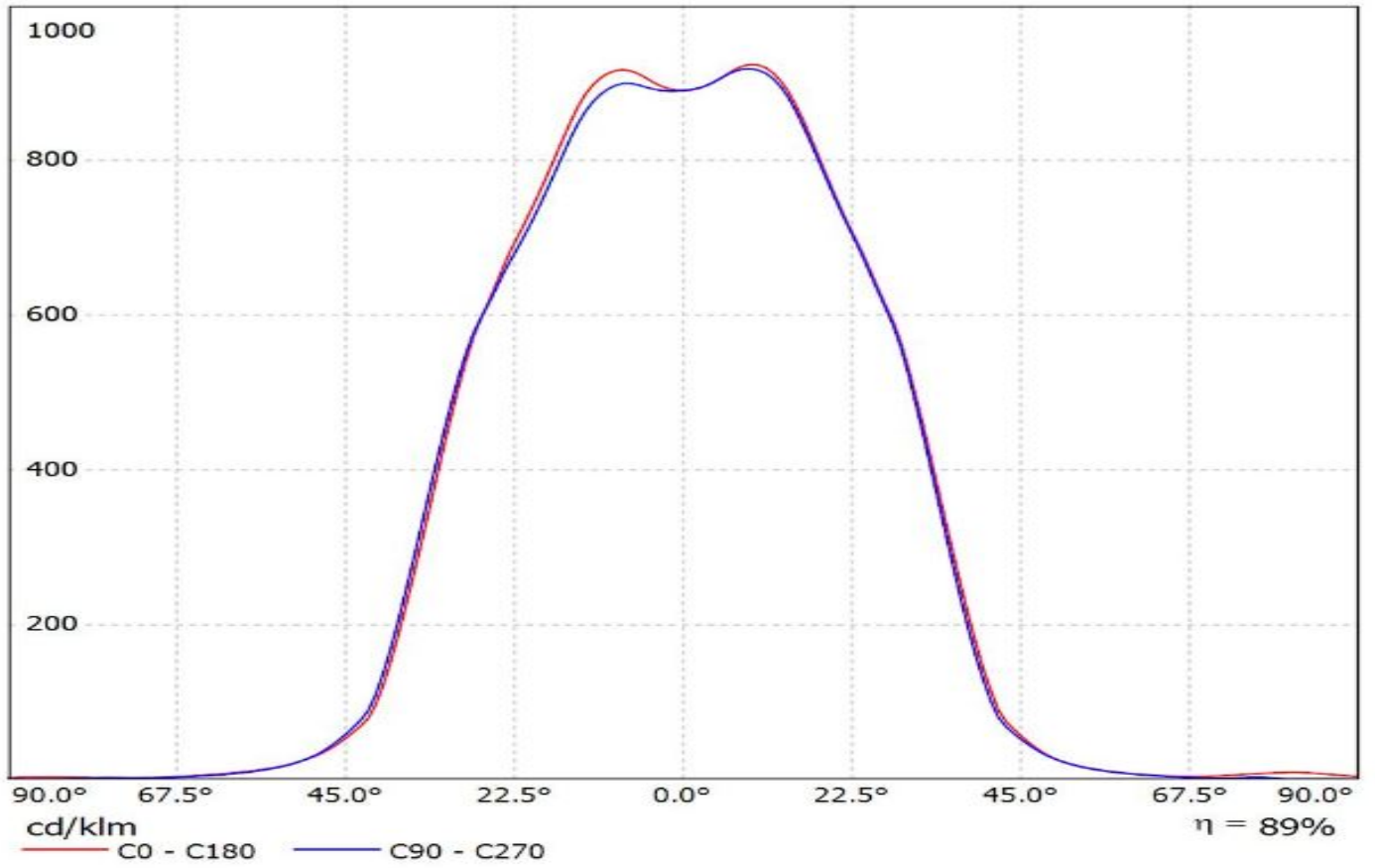

Luminaire: LEDiL Oy F14534_ANGELETTE-WW_(V13_Gen7)+TE

Lamps: 1 x Bridgelux_V13_Gen7_(BXRE-30E2000-B_+TE_2213254-2+TE_2213194-1)_1295.55lm@250mA_P=8.30985W_I=0.25A

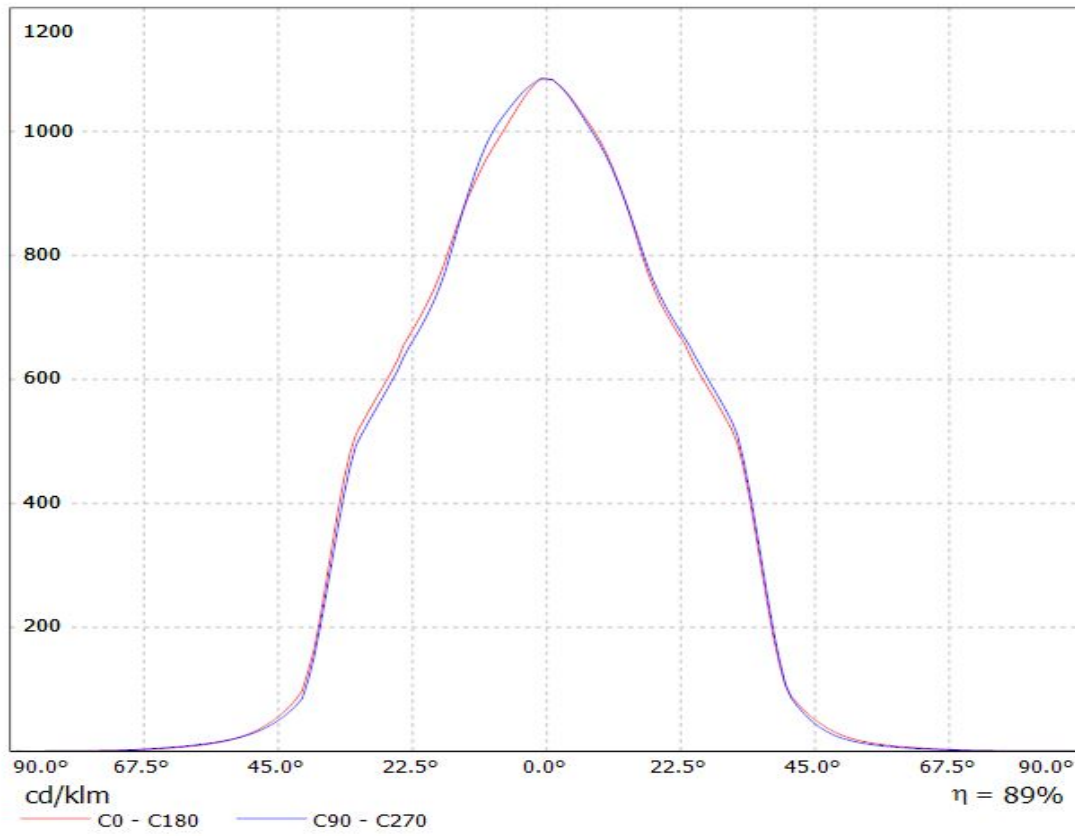

Luminaire: Ledil Oy F14534_ANGELETTE-WW_Bridgelux_V22_Gen7_SIMULATED F14534_ANGELETTE-WW_Bridgelux_V22_Gen7_SIMULATED
Lamps: 1 x F14534_ANGELETTE-WW_Bridgelux_V22_Gen7_SIMULATED

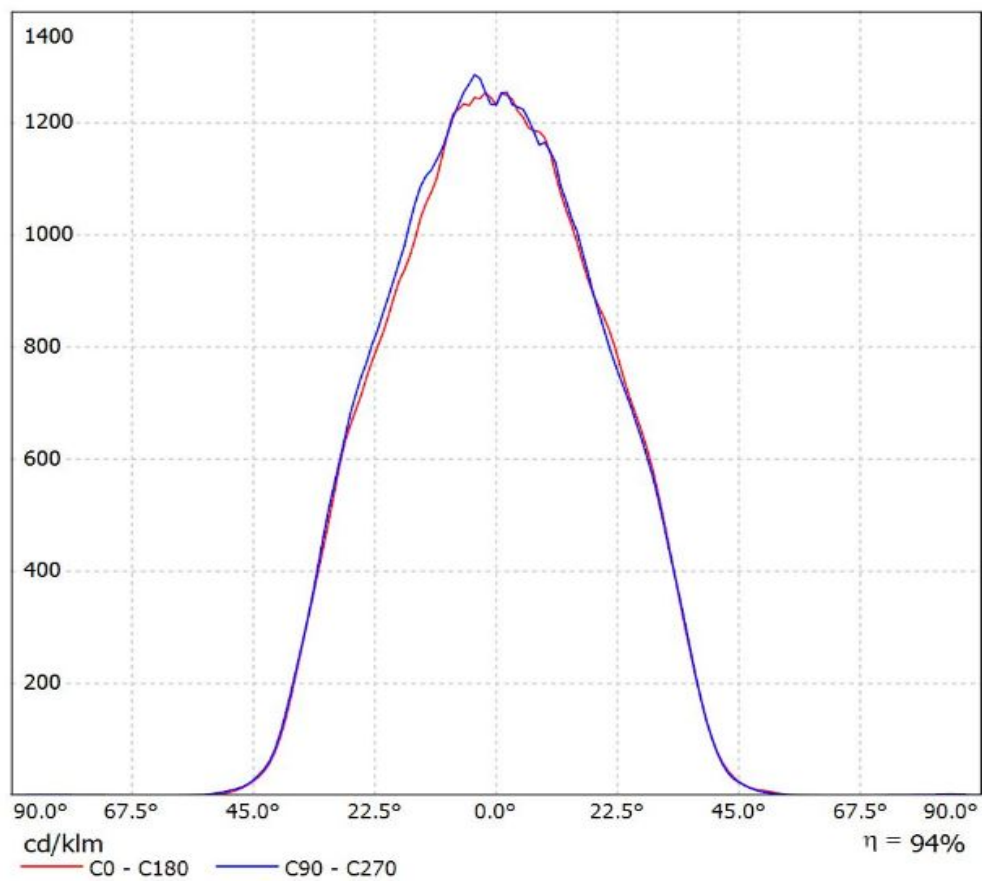

Luminaire: Ledil F14534_ANGELETTE-WWW_(CLU038+TE)
Lamps: 1 x Citizen_CLU038_(-1205C4-273MZK1)_+2213254-2_+2213194-1_1351.18lm@250mA_P=8.4078W_I=0.25A

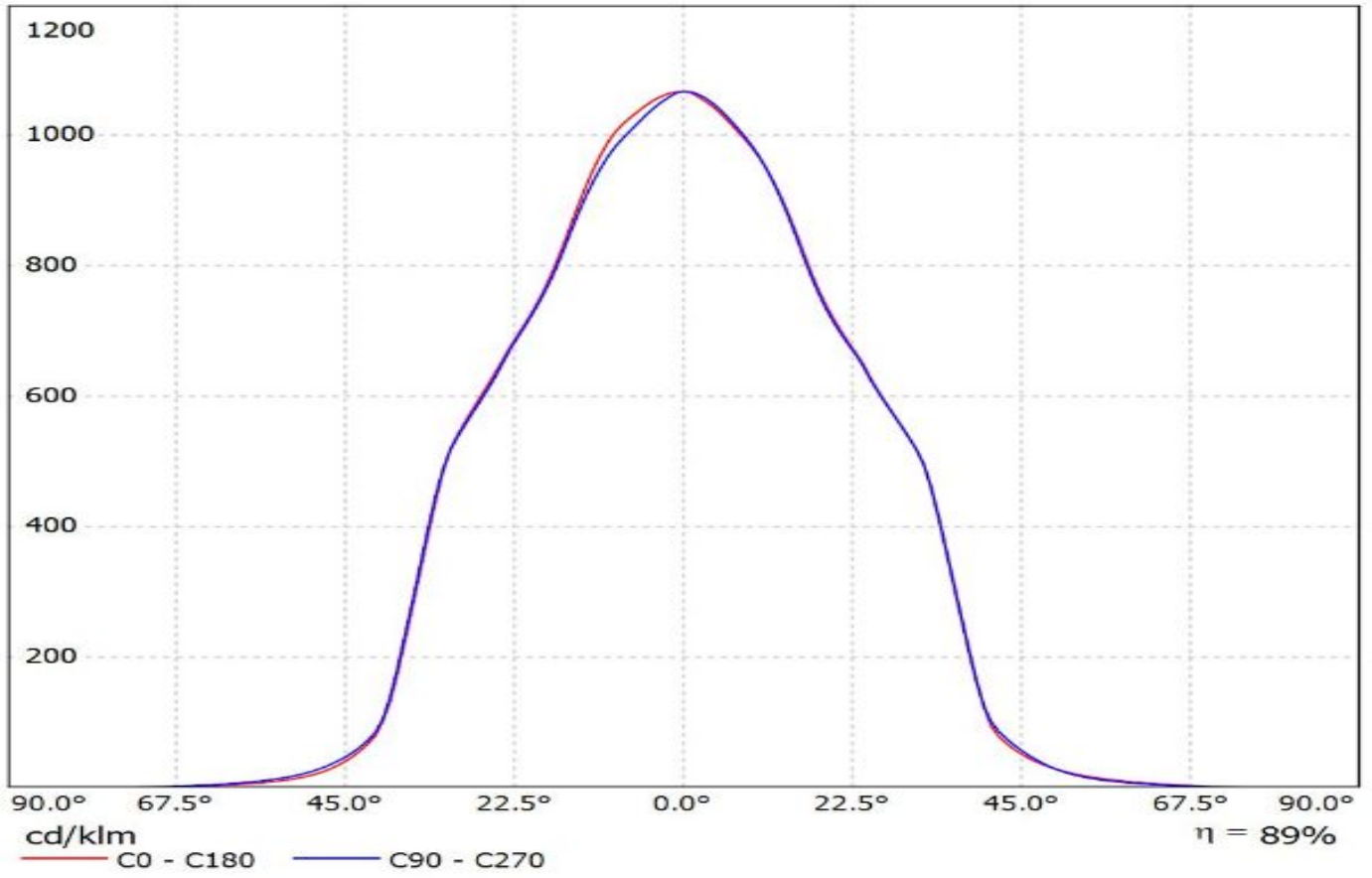

Luminaire: Ledil F14534_ANGELETTE-WW_(CLU036+IDEAL)
Lamps: 1 x CITIZEN_CLU036_(-1208C1-303M2G2)_IDEAL_50-2103CT+50-2100AN_1299.86lm@250mA_CCT=3000K_P=8.249W_I=0.25A

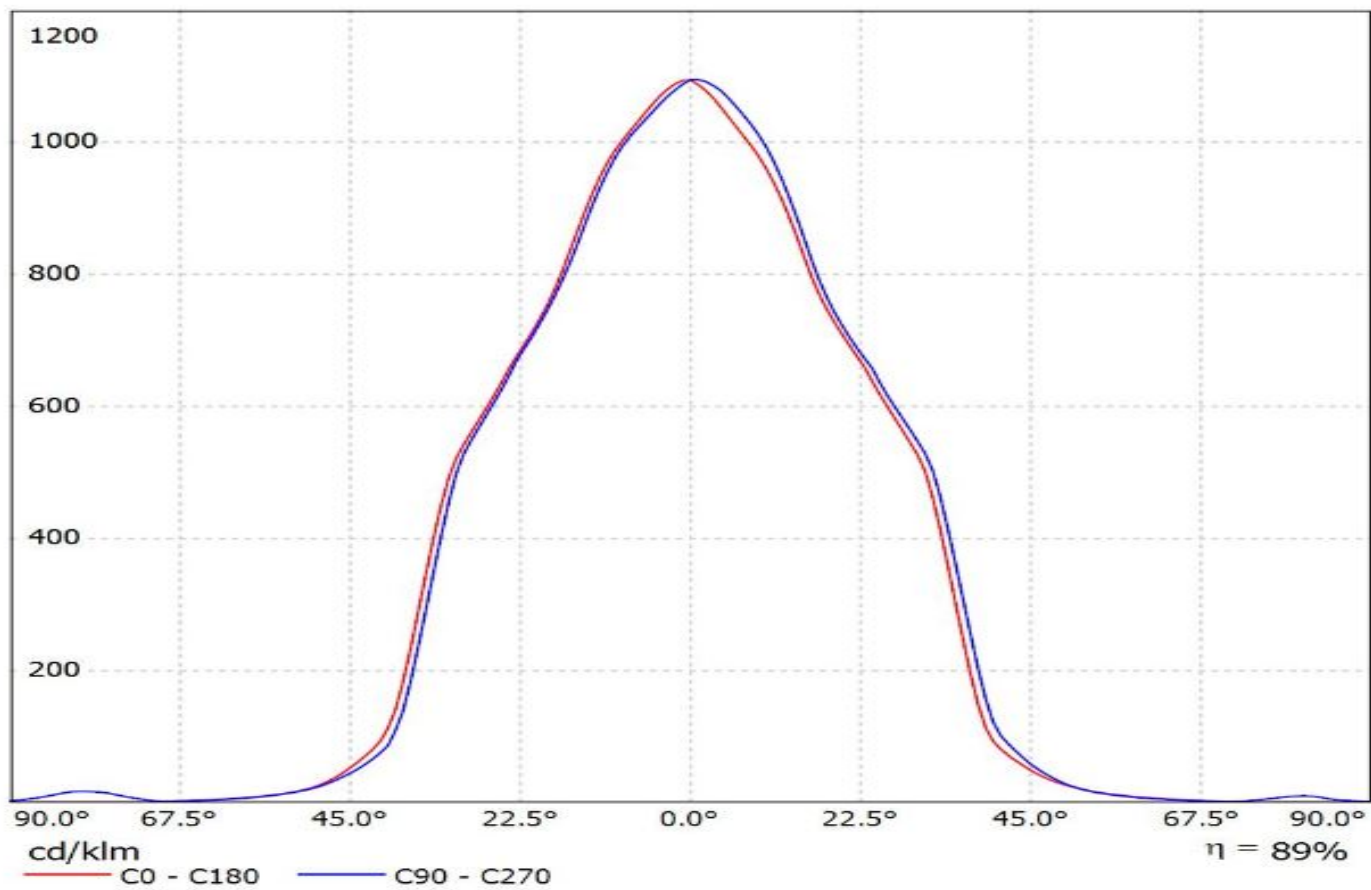

Luminaire: Ledil F14534_ANGELETTE-WW_(CLU730+IDEAL)

Lamps: 1 x Citizen_CLU730_(-1210B8-273M2G1)_IDEAL_50-2204C+50-2100AN

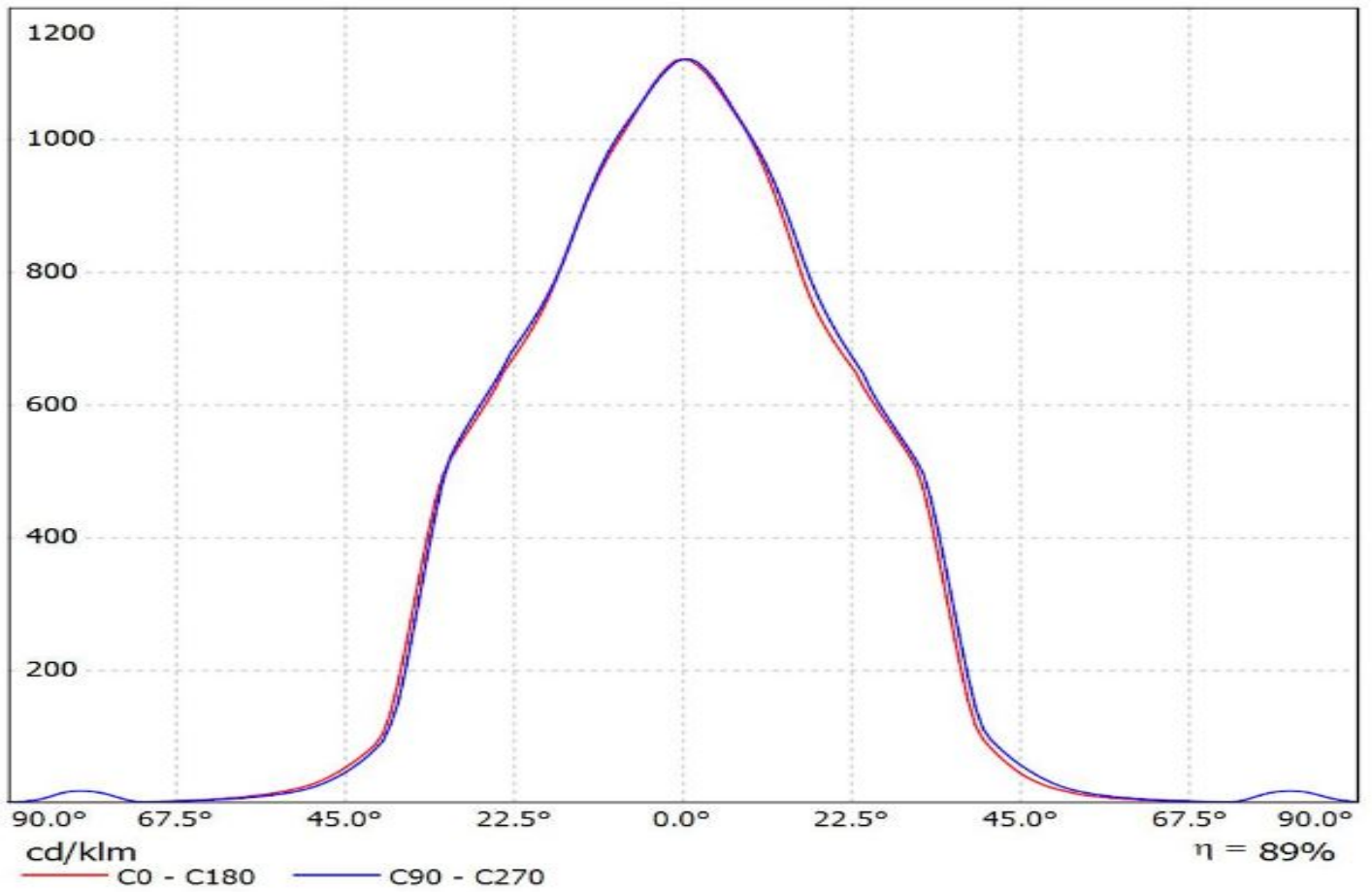

Luminaire: Ledil F14534_ANGELETTE-WW_(CoB1208+IDEAL)
Lamps: 1 x Luxeon_CoB1208+_50-2100SH+50-2100AN_1062.11lm@250mA_CCT=3000K_P=8.3007W_I=0.25A

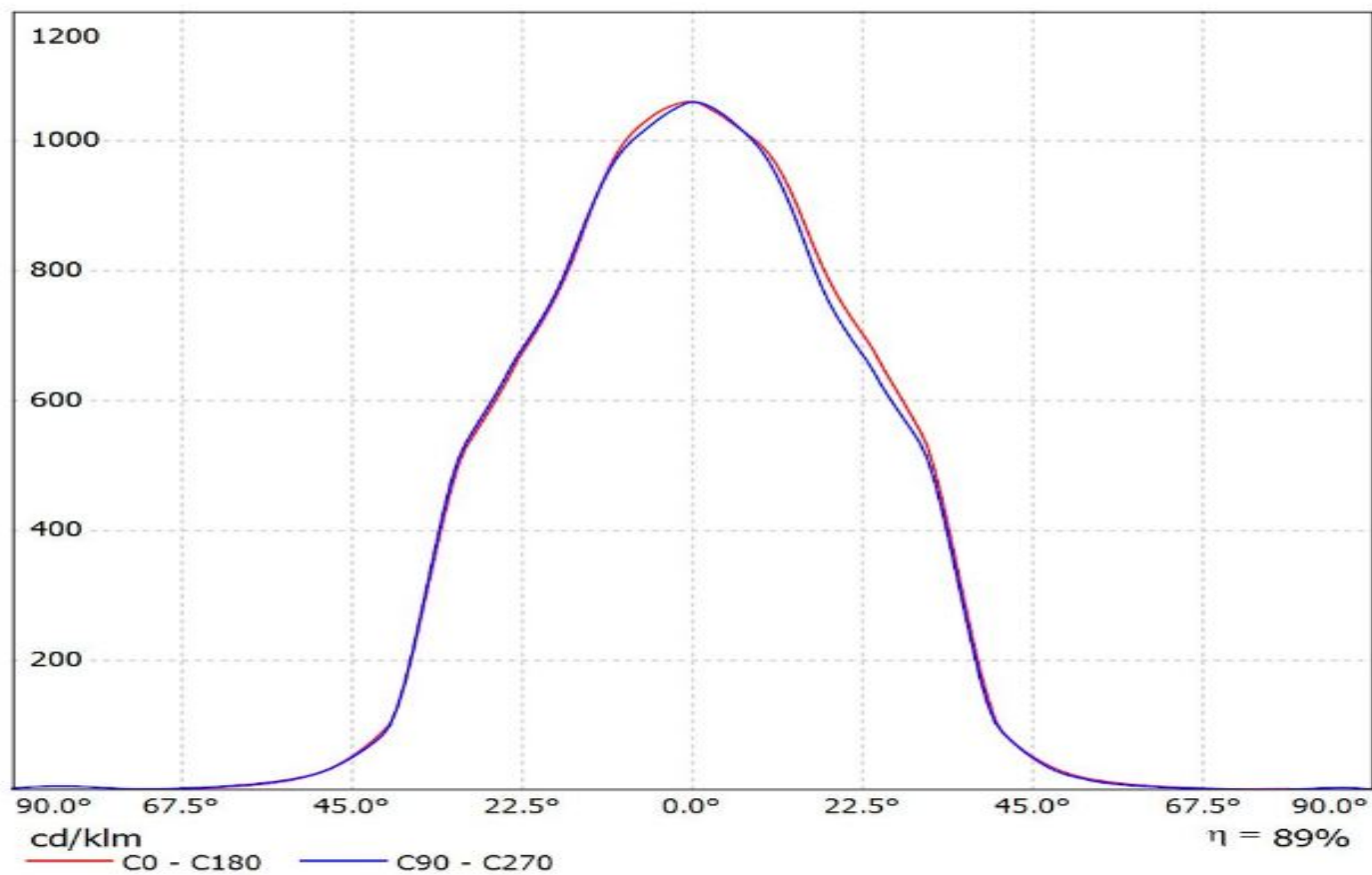

Luminaire: Ledil F14534_ ANGELETTE-WW_(CoB1208+TE)
Lamps: 1 x Luxeon_CoB1208 +_2213130-2+_2213194-
1_1062.11lm@250mA_CCT=3000K_P=8.3007W_I=0.25A

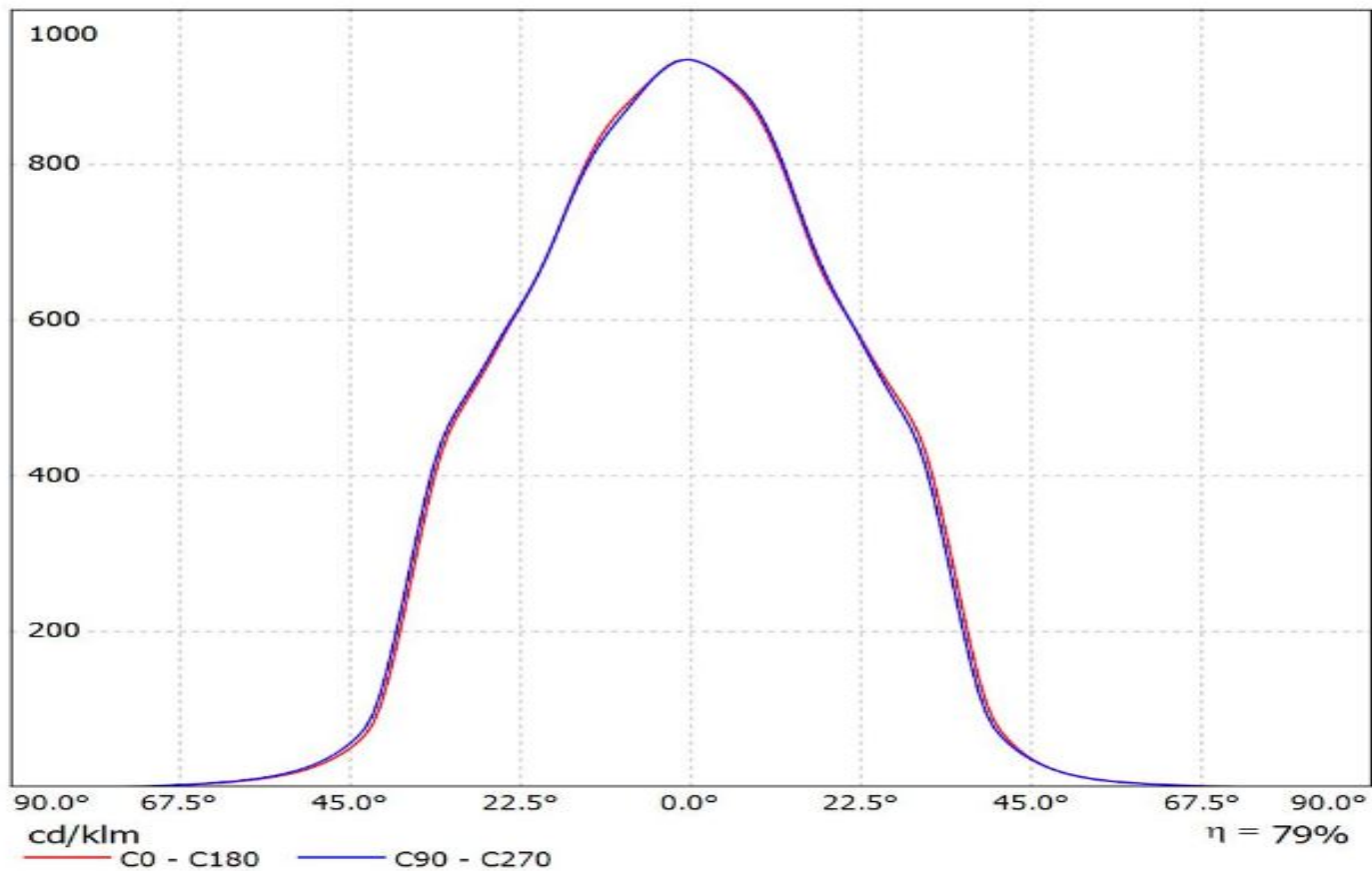

Luminaire: Ledil F14534_ANGELETTE-WW_(CoB1211+IDEAL)
Lamps: 1 x Luxeon_CoB1211_(L2C2-4080)_50-2204CT+50-2100AN_1376.18lm@250mA_P=7.9988W_I=0.25A

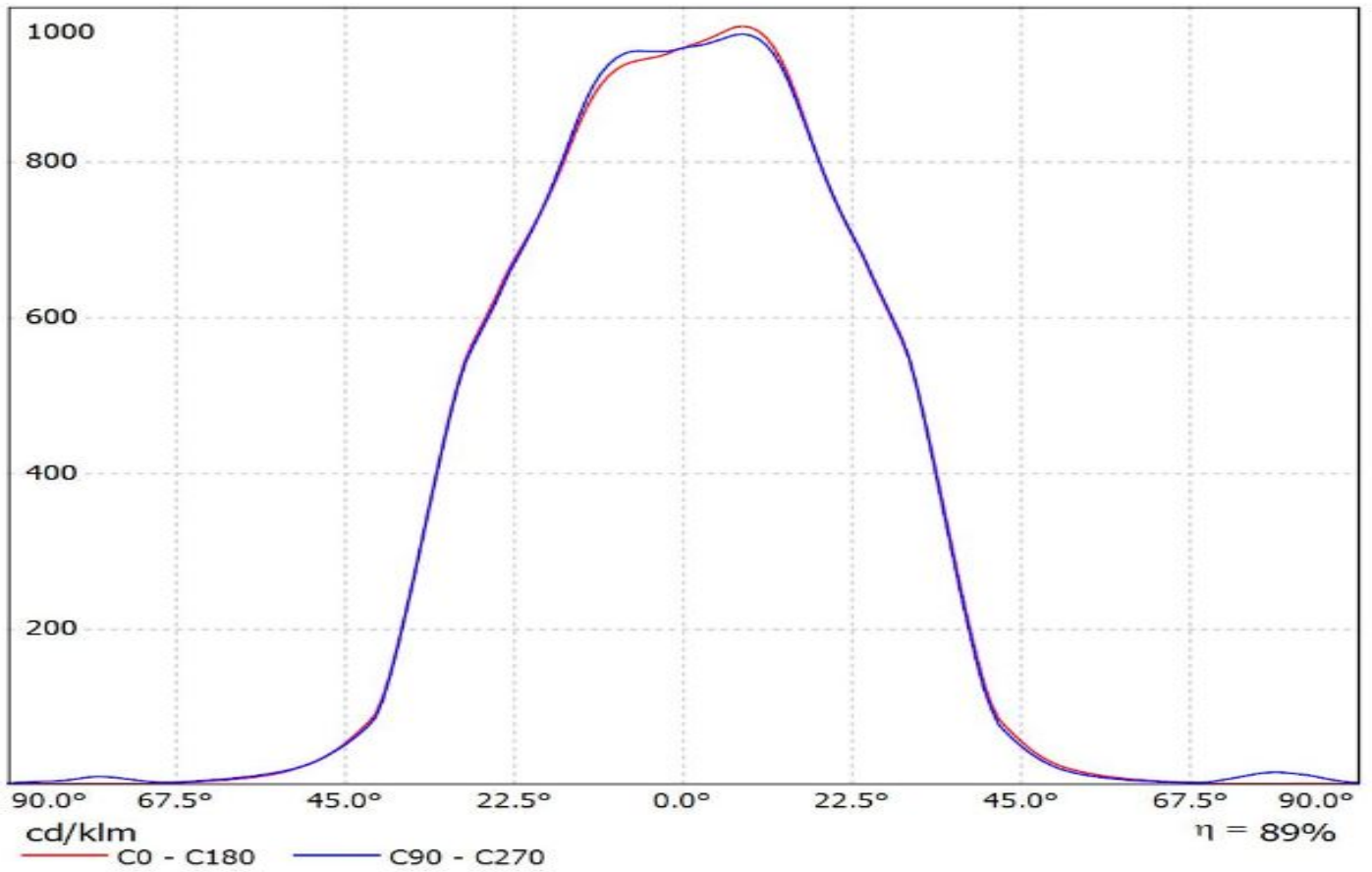

Luminaire: Ledil F14534_ANGELETTE-WWW_(CoB1216_IDEAL)
Lamps: 1 x Luxeon_CoB1216_(L2C2-40801216E2300)_+50-2204C_+_50-2100AN_1447.57lm@250mA_CCT=4000K_P=8.0135W_I=0.25A

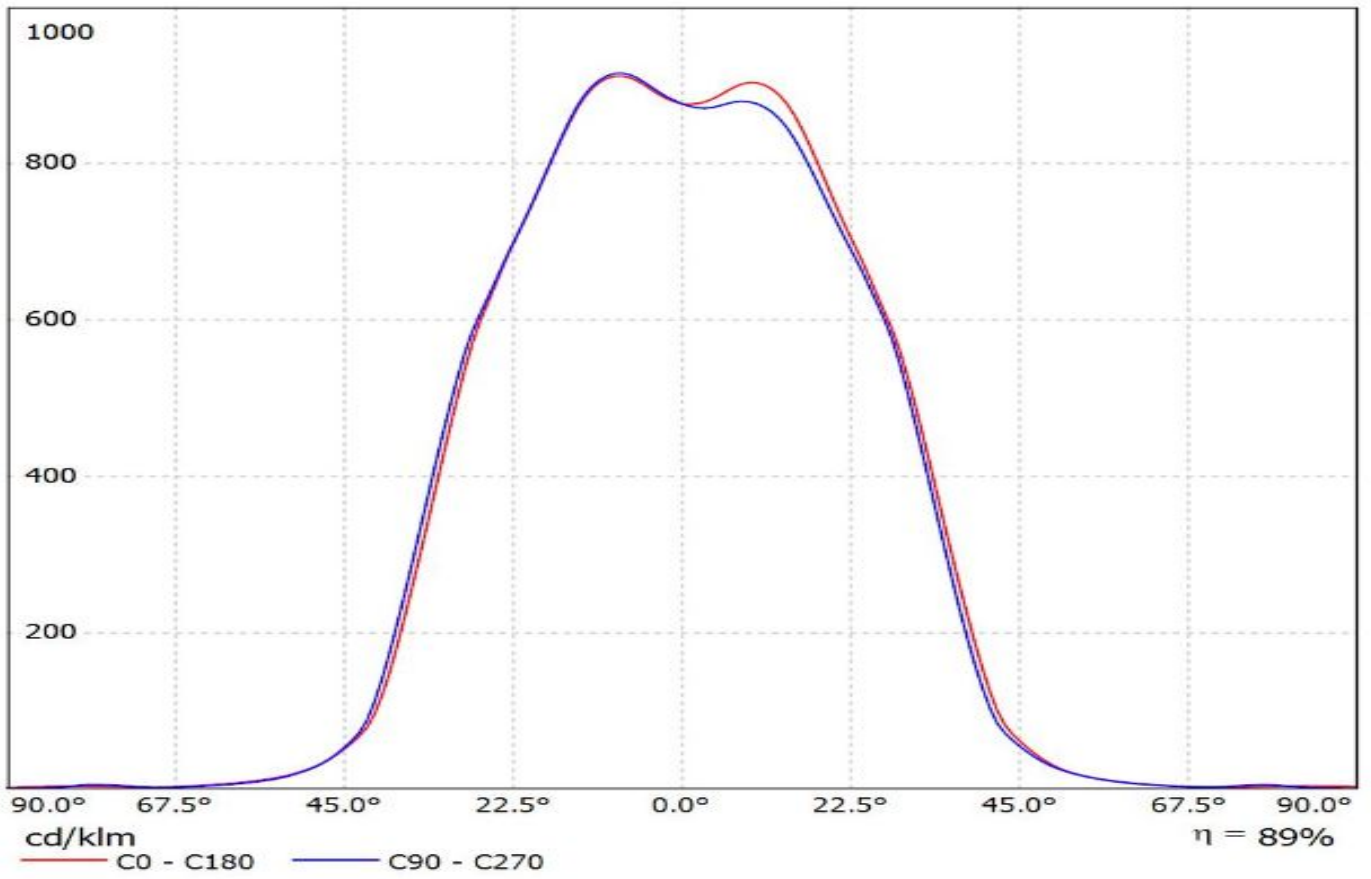

Luminaire: Ledil F14534_ANGELETTE-WWW_(NVCLL024Z+IDEAL)

Lamps: 1 x Nichia_NVCxL024z_(NVCLL024z)_975.455lm@250mA_P=8.1468W_I=250A

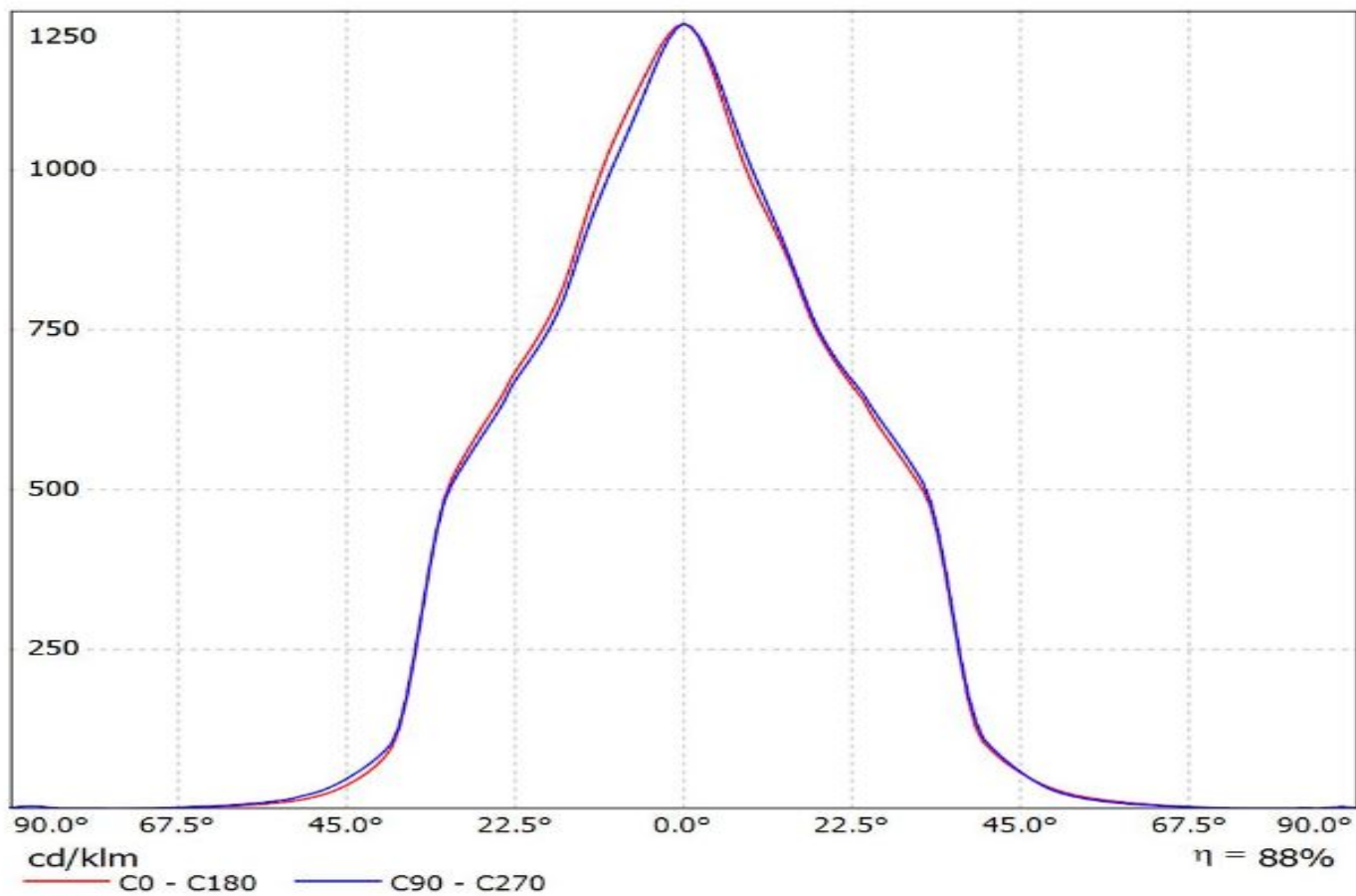

Luminaire: LEDiL Oy F14534_ANGELETTE-WW_(NFDLJ130B+IDEAL)

Lamps: 1 x Nichia_NFDLJ130B_+50-2103NC_+50-2100AN_1422.52lm@250mA_CCT=4000K_P=8.91686W_I=0.25A

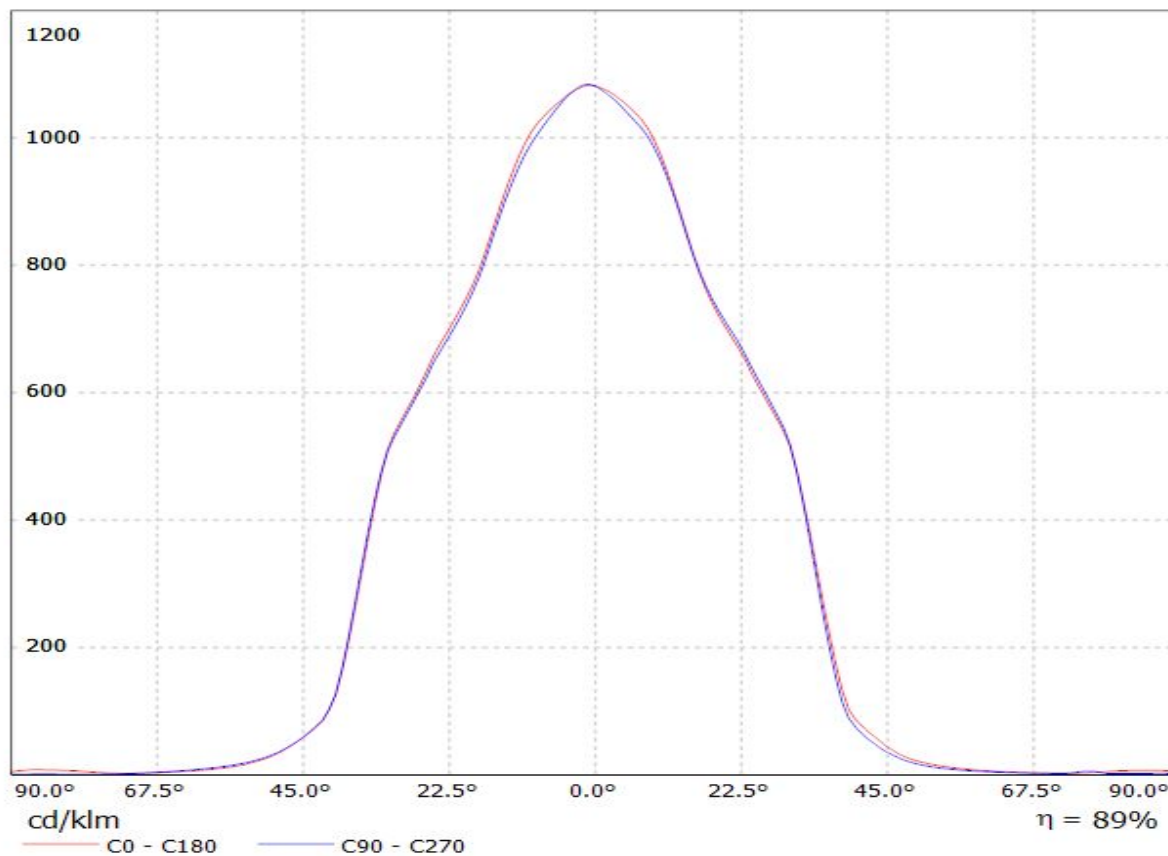

Luminaire: Ledil F14534_ANGELETTE-WW_(PREVALED_Core_Z4)

Lamps: 1 x PREVALED_Core_Z4_LES19_1470.62lm@250mA_P=10.828W_I=0.25A

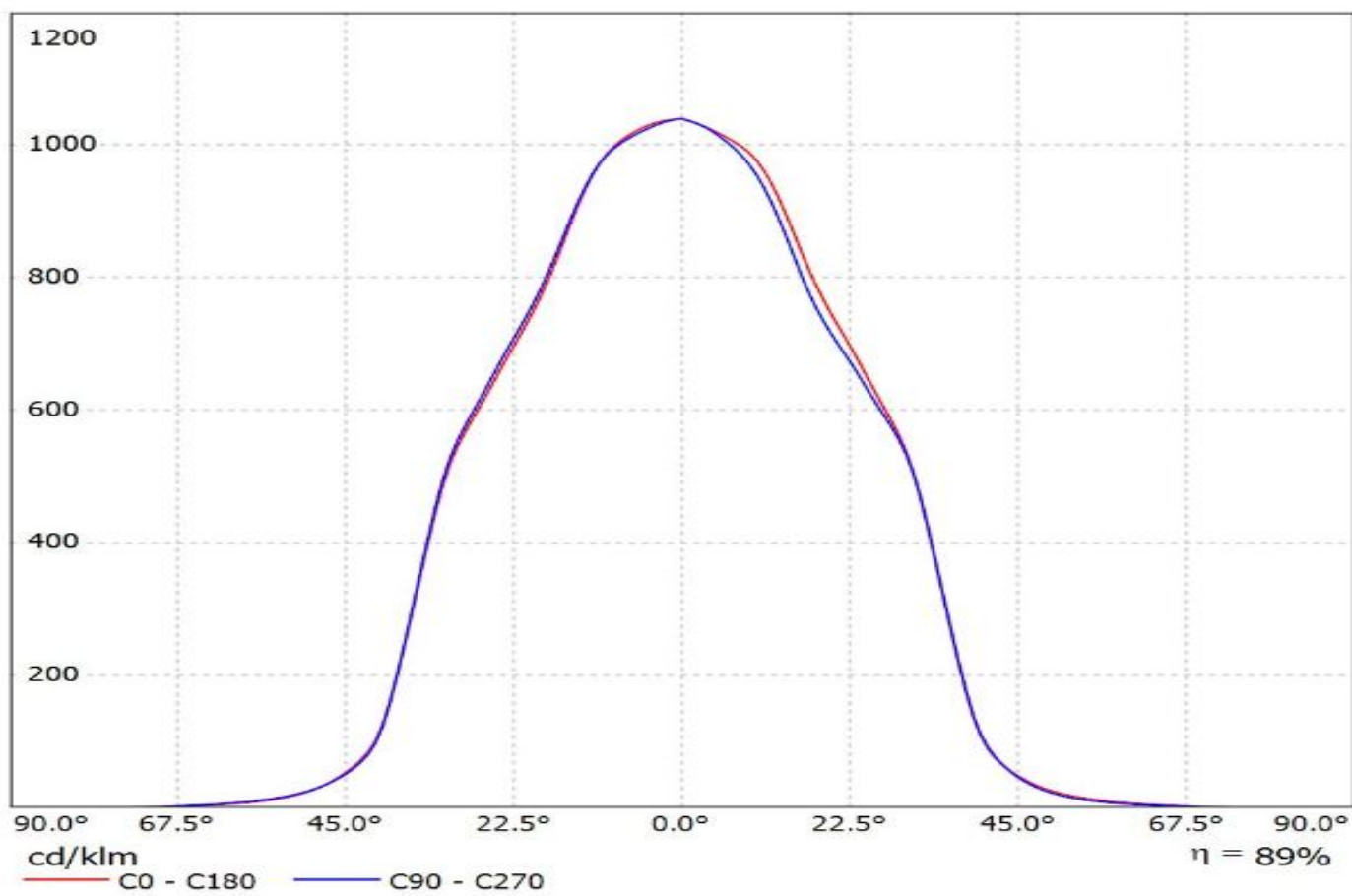

Luminaire: Ledil F14534_ANGELETTE-WW_(S19+TE)
Lamps: 1 x Osram_Solericq_S19_(GW_KAHJB1.EM)_+2213407-2+2213194-
1_1546.1lm@250mA_CCT=3000K_P=11.021W_I=0.25A

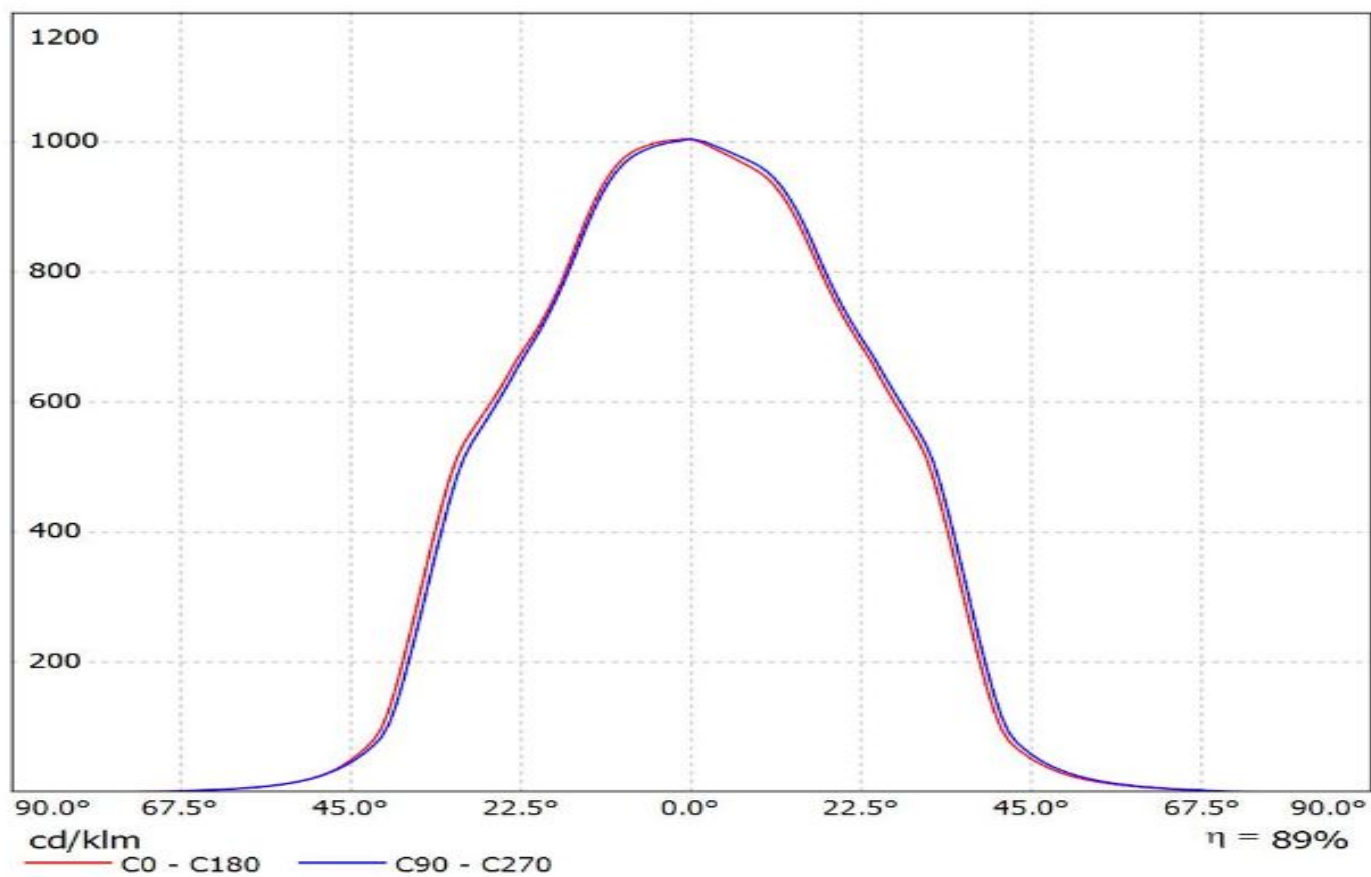

Luminaire: Ledil F14534_ANGELETTE-WW_(S13_Gen2+IDEAL)

Lamps: 1 x Soleriq_S13_Gen2+_50-2103CT+_50-2100AN_1327.38lm@250mA_P=8.7850W_I=0.250A

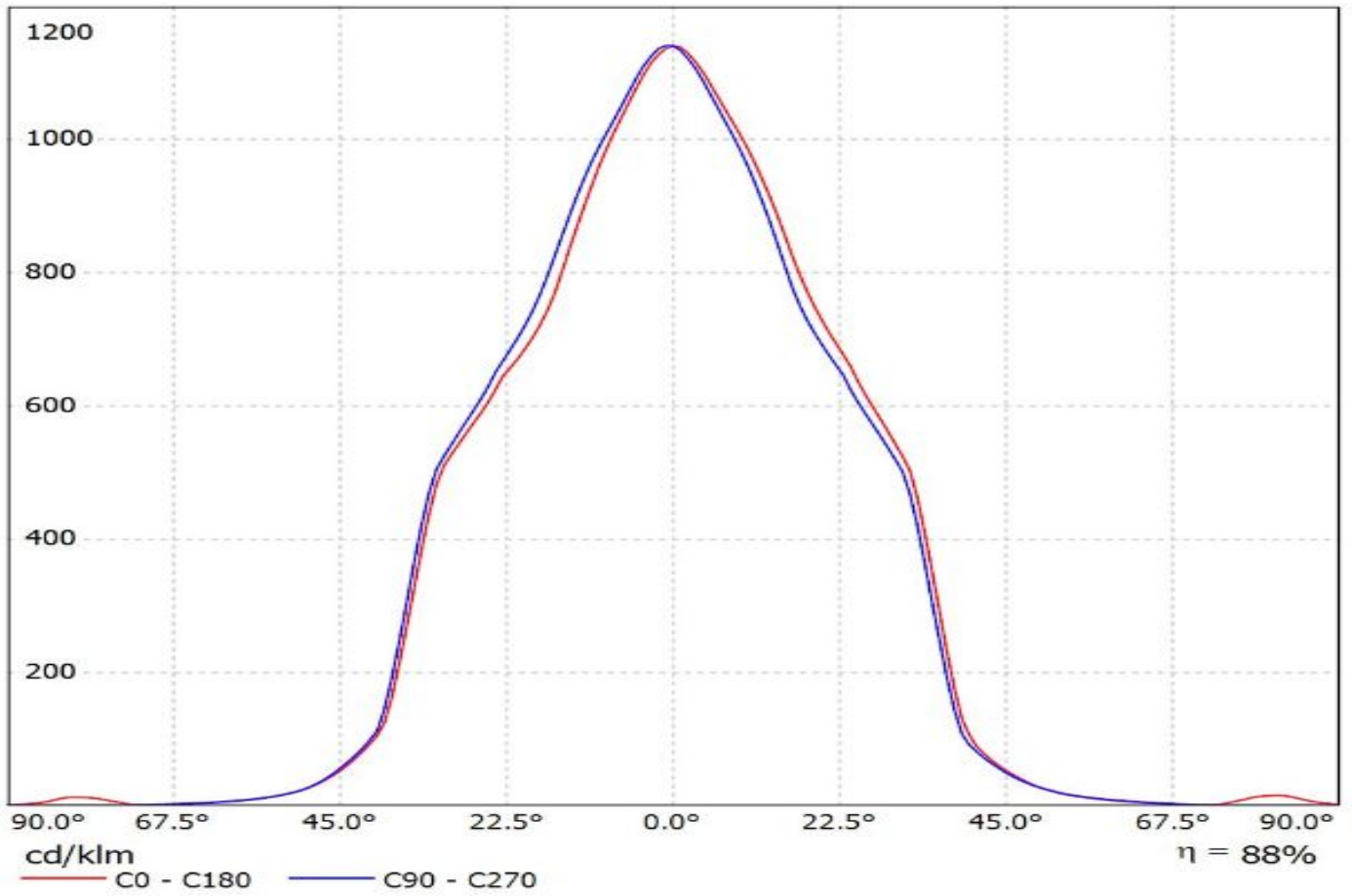

Luminaire: Ledil F14534_ANGELETTE-WW_(SLM_G5_LES_15_+TE)

Lamps: 1 x Philips_SLM_G5_LES_15_+TE_2213194-1_1277.72lm@250mA_P=8.208W_I=0.25A

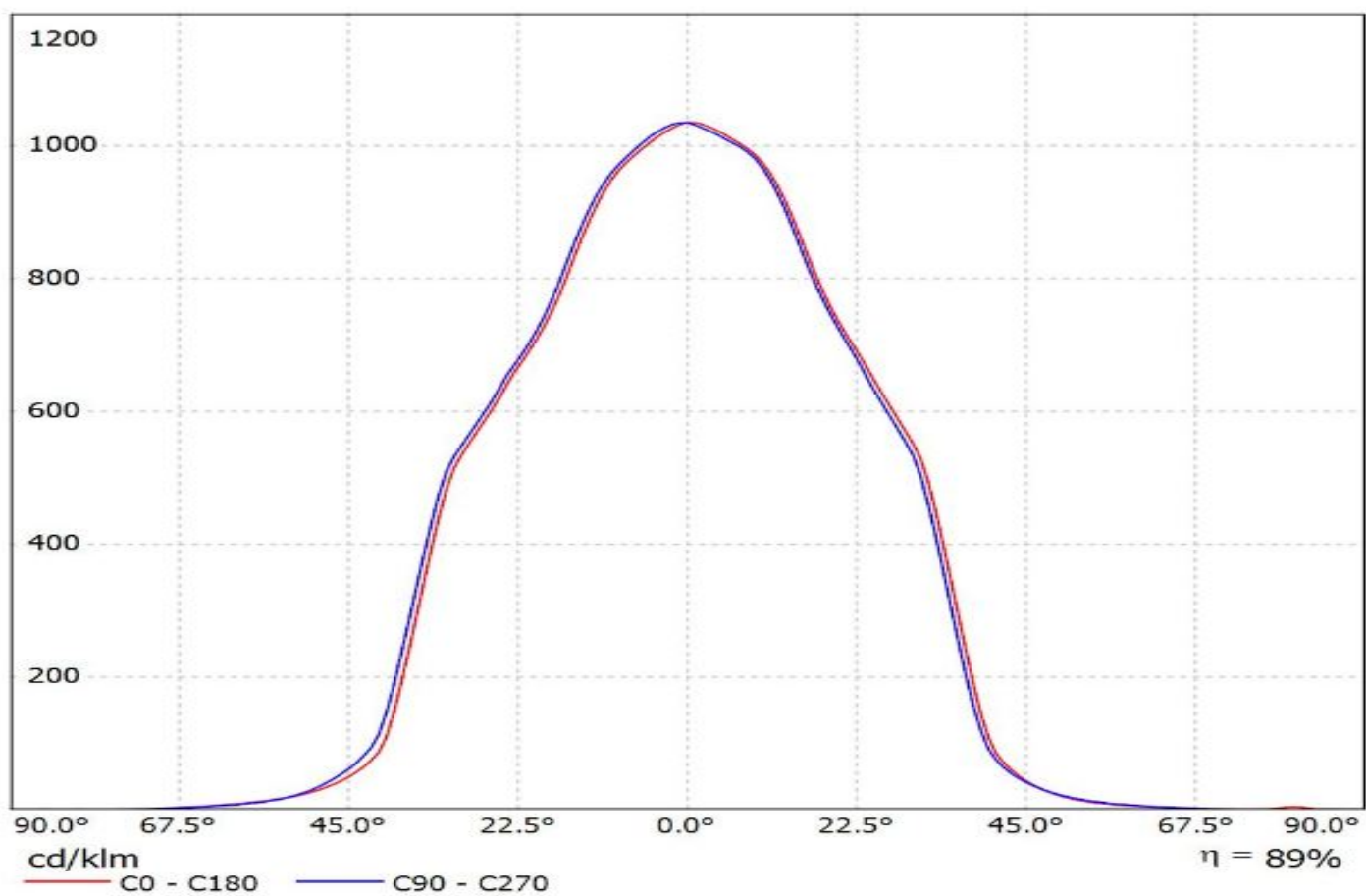

Luminaire: Ledil F14534_ANGELETTE-WW_(LC040C+TE)

Lamps: 1 x Samsung_LC040C+_2213382-2+_2213194-1_1194.16lm@250mA_CCT=4000K_P=8.137W

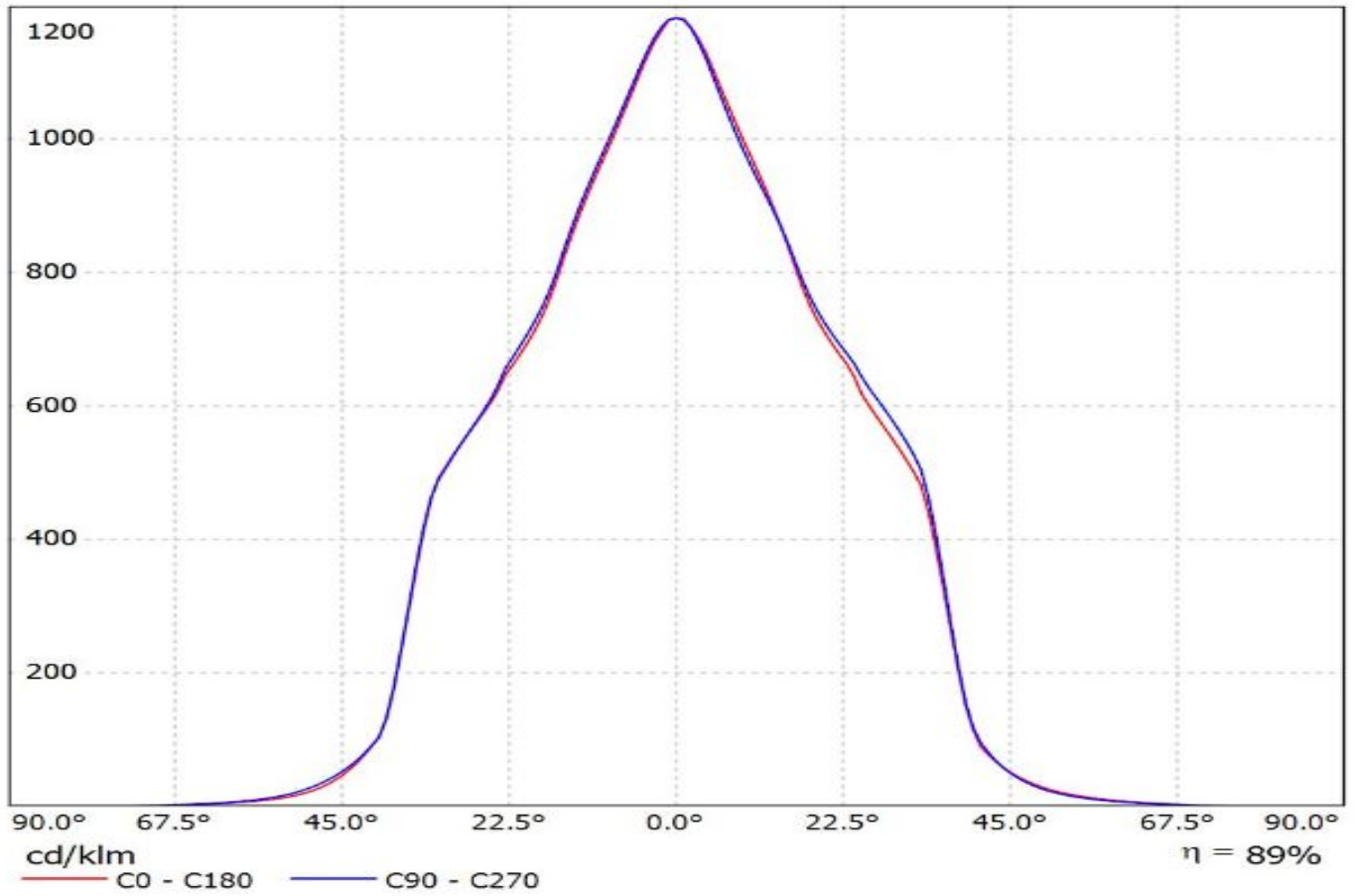

Luminaire: Ledil F14534_ANGELETTE-WW_(SEOUL_AC_Zhaga_COB)
Lamps: 1 x SEOUL_AC_Zhaga_COB

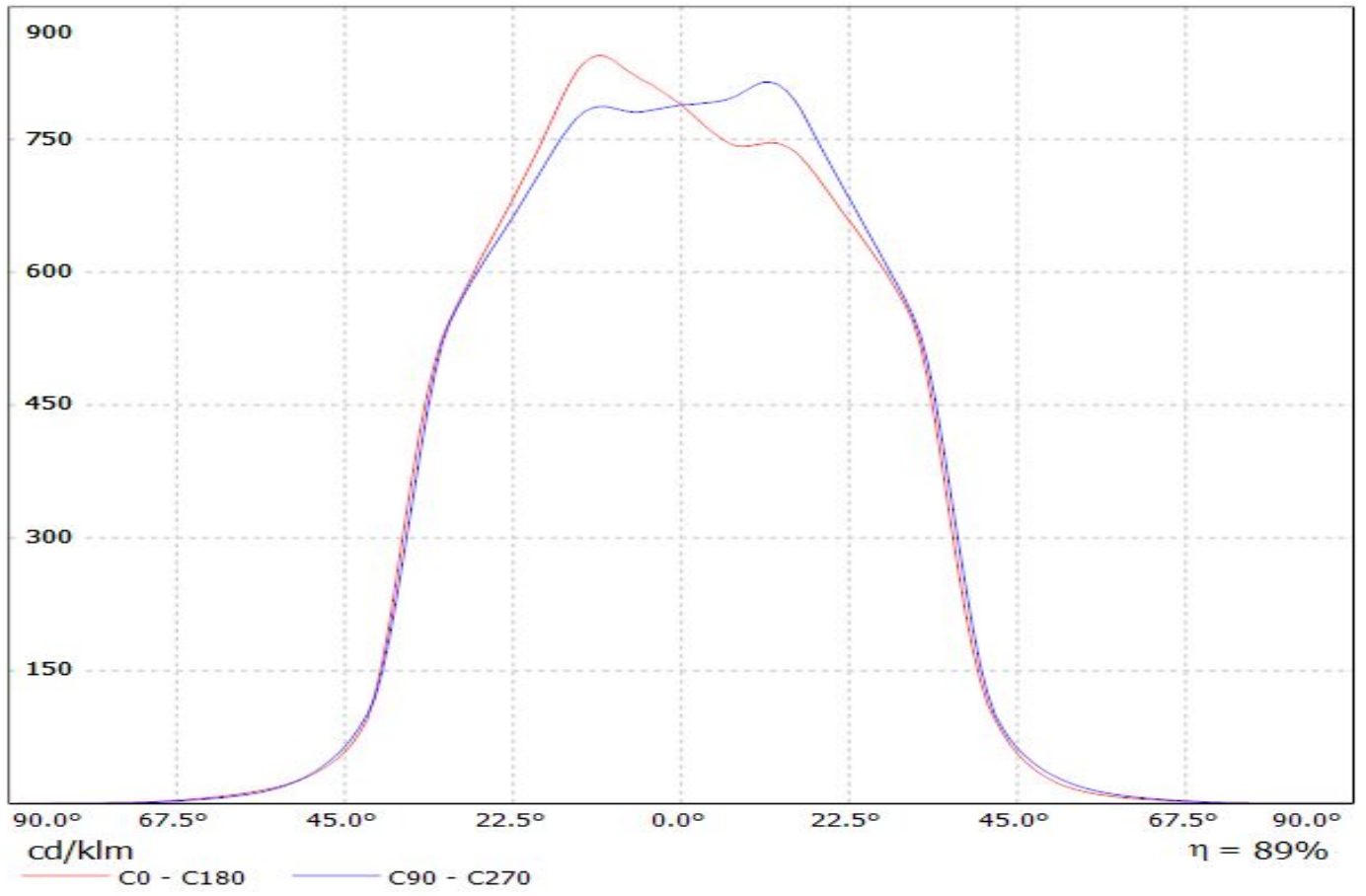

Luminaire: Ledil F14534_ANGELETTE-WW_(MJT_30W_Les14,5)_TE

Lamps: 1 x Seoul_MJT_30W_Les14,5mm_(SAWx1566A)_+TE_2213254-2_+_TE_2213194-1_1328.6lm@250mA_P=8.24025W_I=0.25A

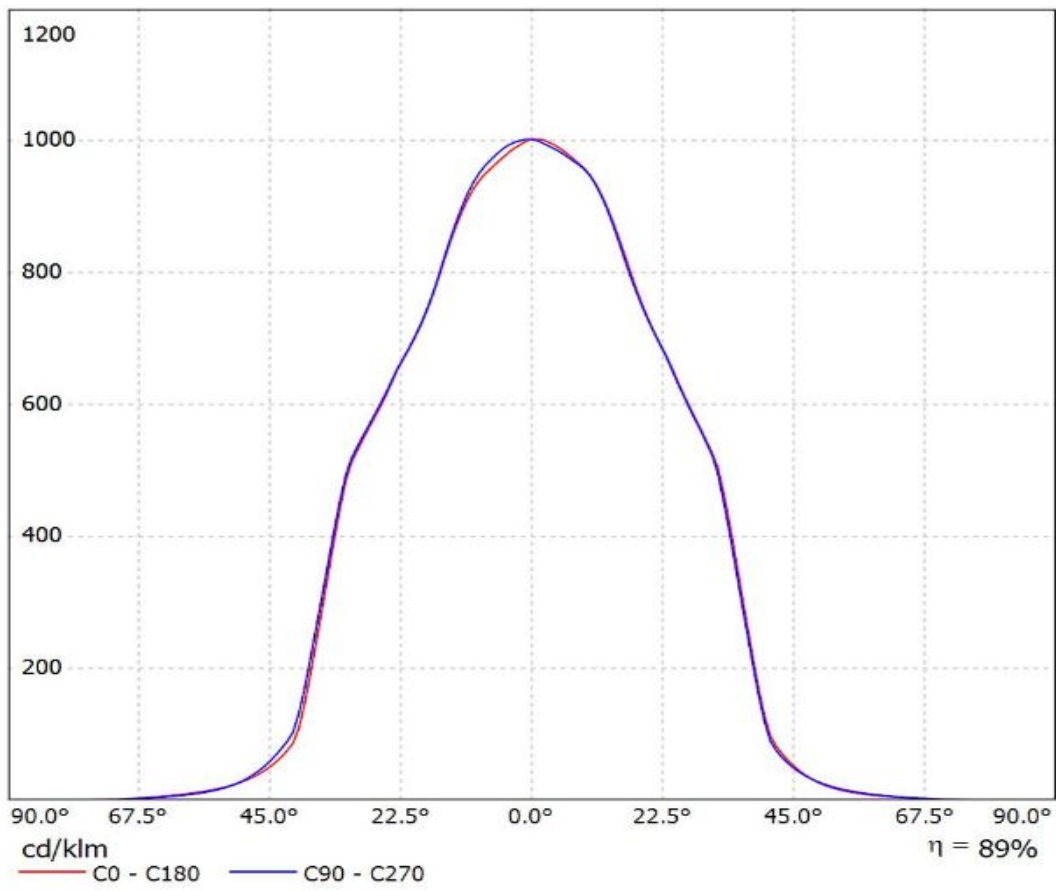

Luminaire: Ledil Oy F14534_ANGELETTE-WW_(SLE_G6_LES15)_(2213254-2+_2213194-1)
_SIMULATED
Lamps: 1 x Tridonic SLE G6 LES15 + Tyco Electronics 2213254-2 + TE 2213194-1 Optic clip

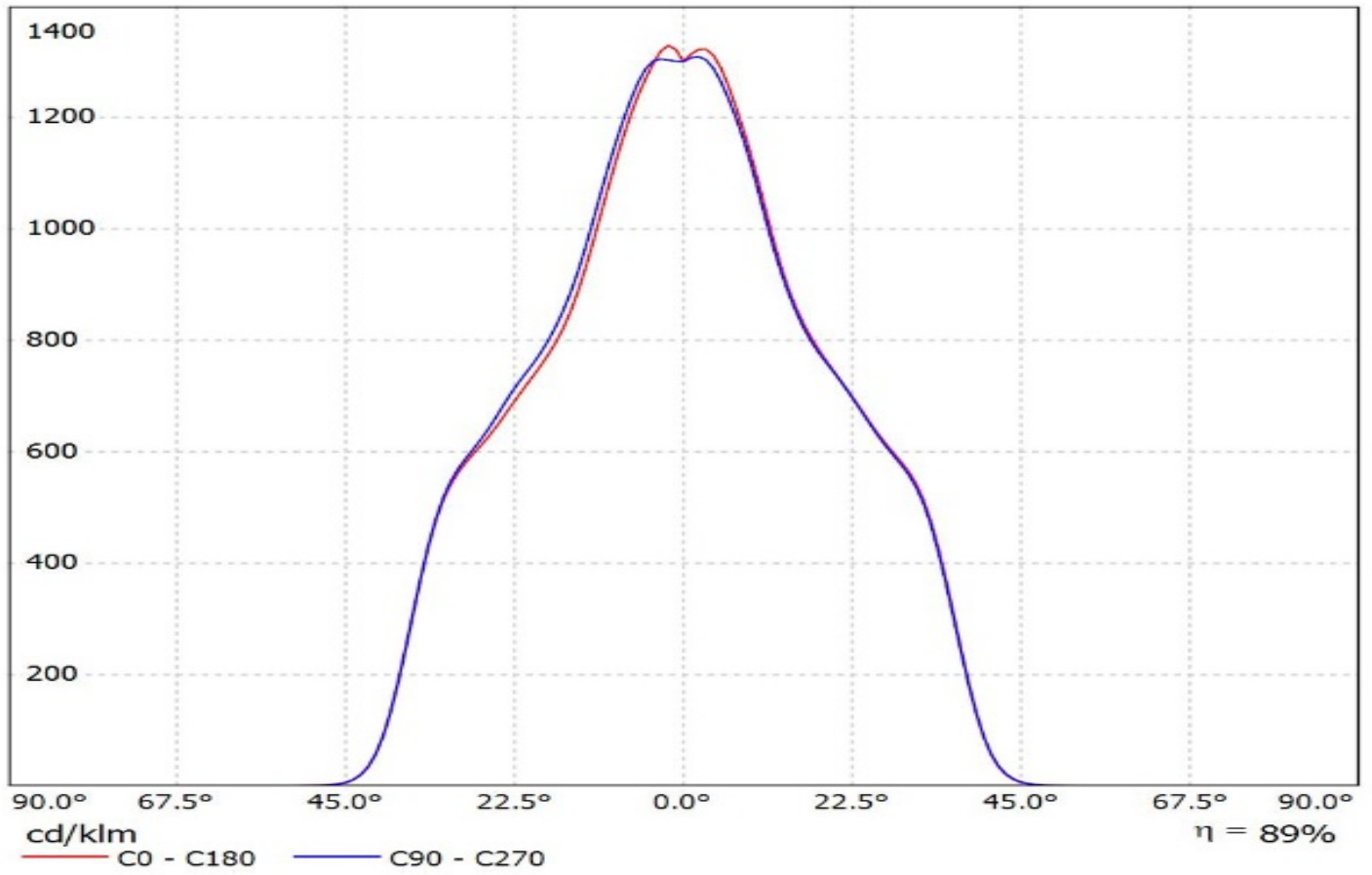

Luminaire: Ledil Oy F14534_ANGELETTE-WW+_TE_2213254-2+_TE_Z50_Type1_TRIDONIC_SLE_G6_LES17_SIMULATED
Lamps: 1 x TRIDONIC SLE G6 LES17

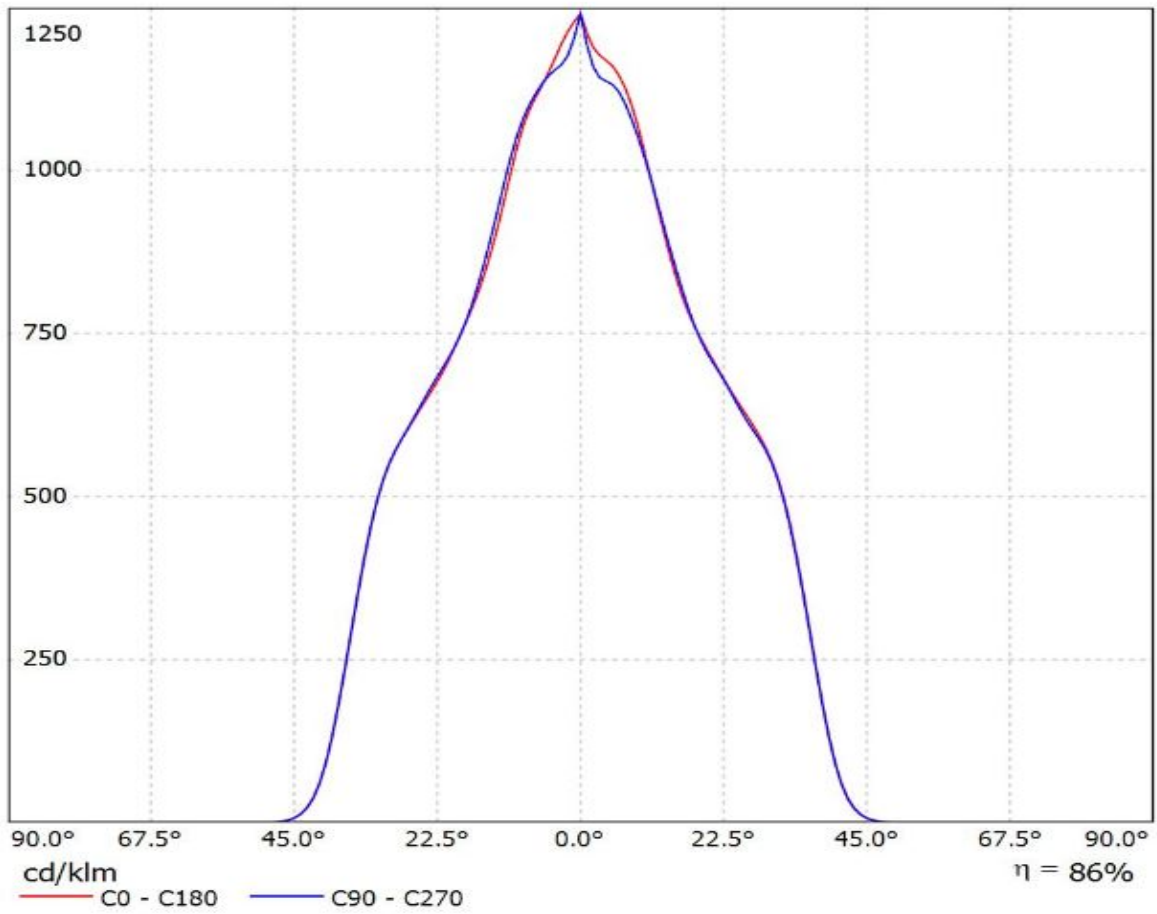

Luminaire: Ledil F14534_ANGELETTE-WW_(WU-M-484+TE)

Lamps: 1 x Vossloh_Schwabe_WU-M-484-830_681.21lm@250mA_P=5.6195W_I=0.25A

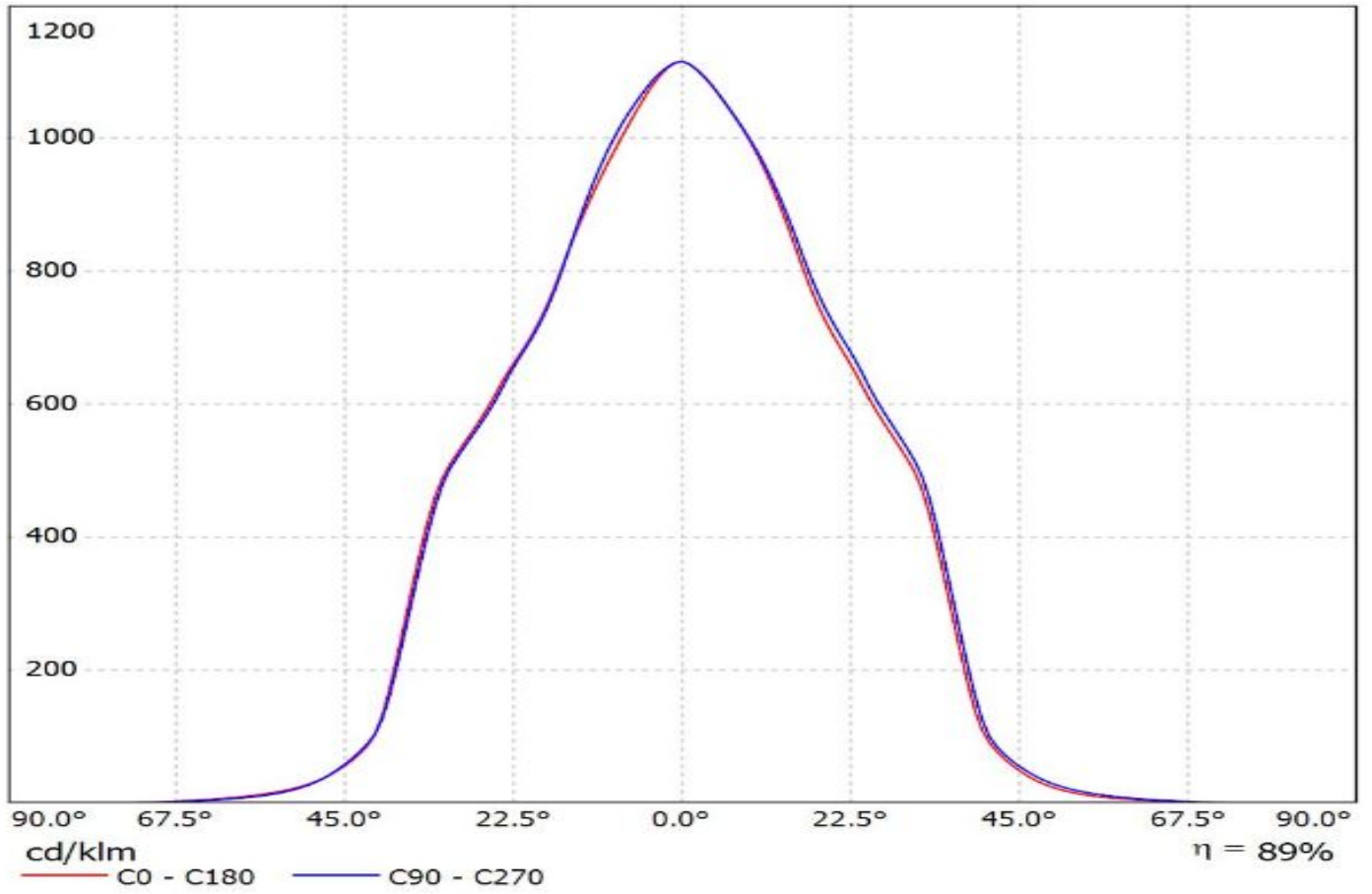

Luminaire: Ledil F14534_ANGELETTE-WW_(V22+IDEAL)
Lamps: 1 x Bridgelux_V22_(BXRE30E6500H-Y2)_+50-2204CT_+_50-2100AN_1193.54lm@250mA_CCT=3000K_P=8.0988W_I=0.25A

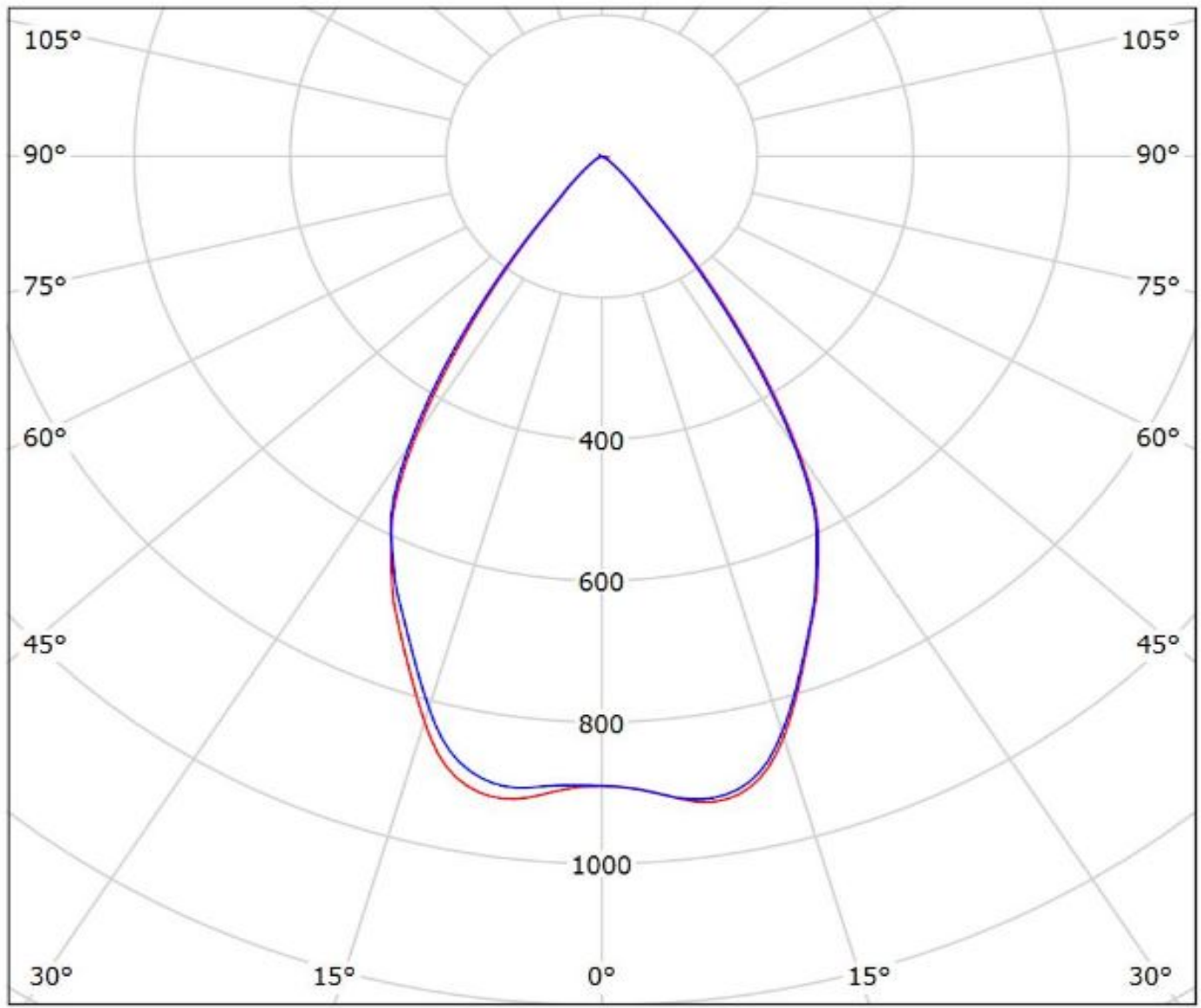

cd/klm
— C0 - C180 — C90 - C270

$\eta = 89\%$

Luminaire: LEDiL Oy F14534_ANGELETTE-WW_(V13_Gen7)+TE

Lamps: 1 x Bridgelux_V13_Gen7_(BXRE-30E2000-B_+TE_2213254-2+TE_2213194-1)_1295.55lm@250mA_P=8.30985W_η=0.25A

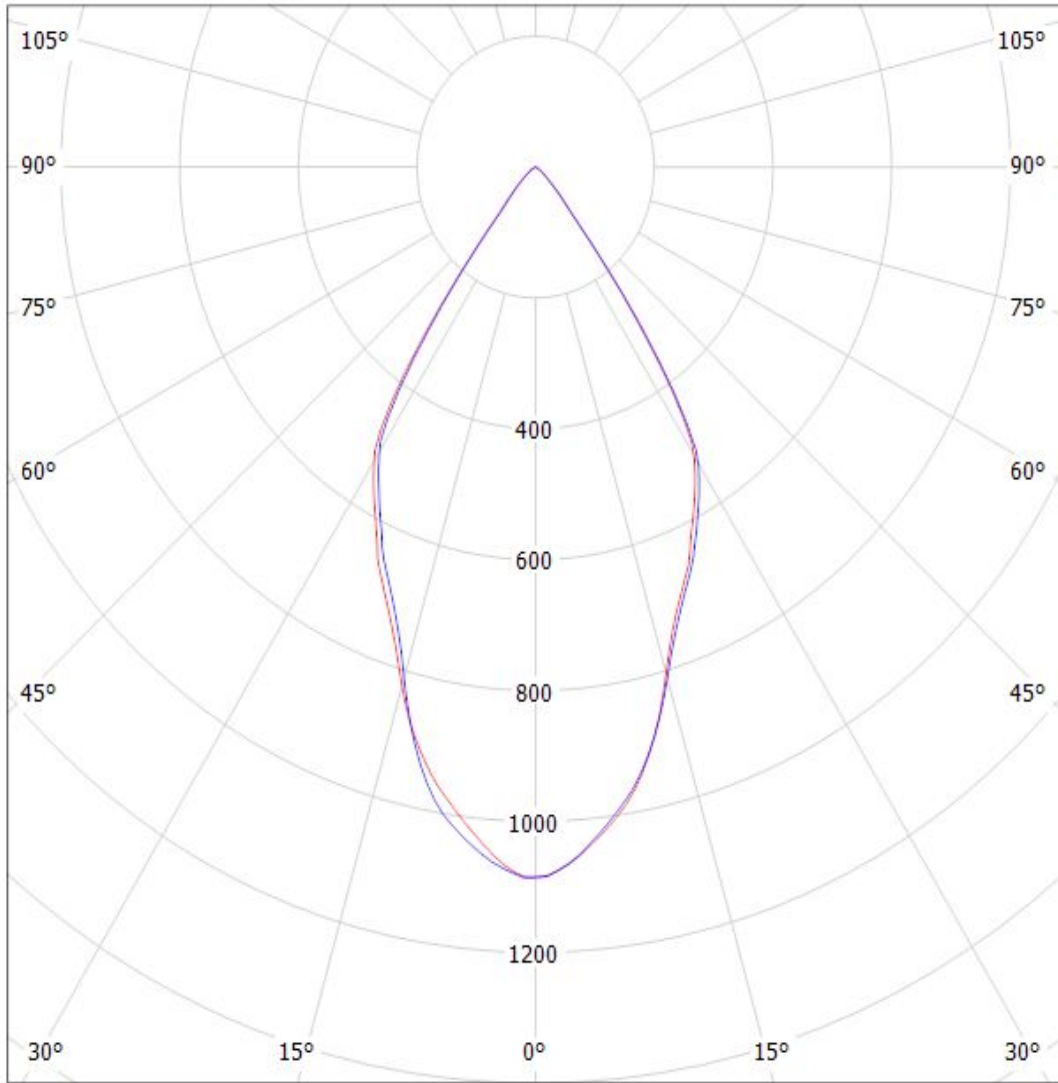

cd/klm

— C0 - C180 — C90 - C270

η = 89%

Luminaire: Ledil Oy F14534_ANGELETTE-WW_Bridgelux_V22_Gen7_SIMULATED F14534_ANGELETTE-WW_Bridgelux_V22_Gen7_SIMULATED
Lamps: 1 x F14534_ANGELETTE-WW_Bridgelux_V22_Gen7_SIMULATED

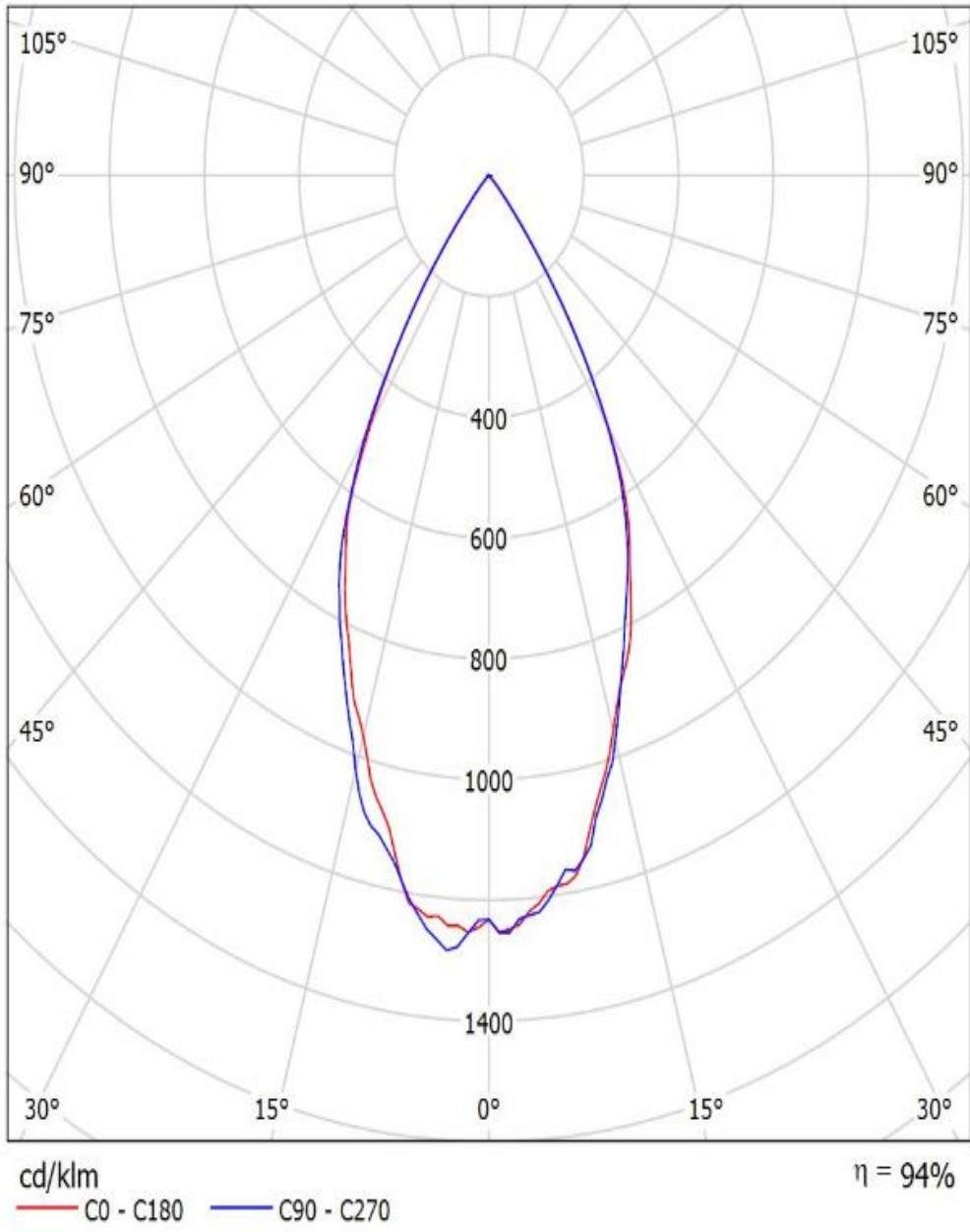

Luminaire: Ledil F14534_ANGELETTE-WW_(CLU038+TE)
Lamps: 1 x Citizen_CLU038_(-1205C4-273MZK1)_+2213254-2_+2213194-1_1351.18lm@250mA_P=8.4078W_I=0.25A

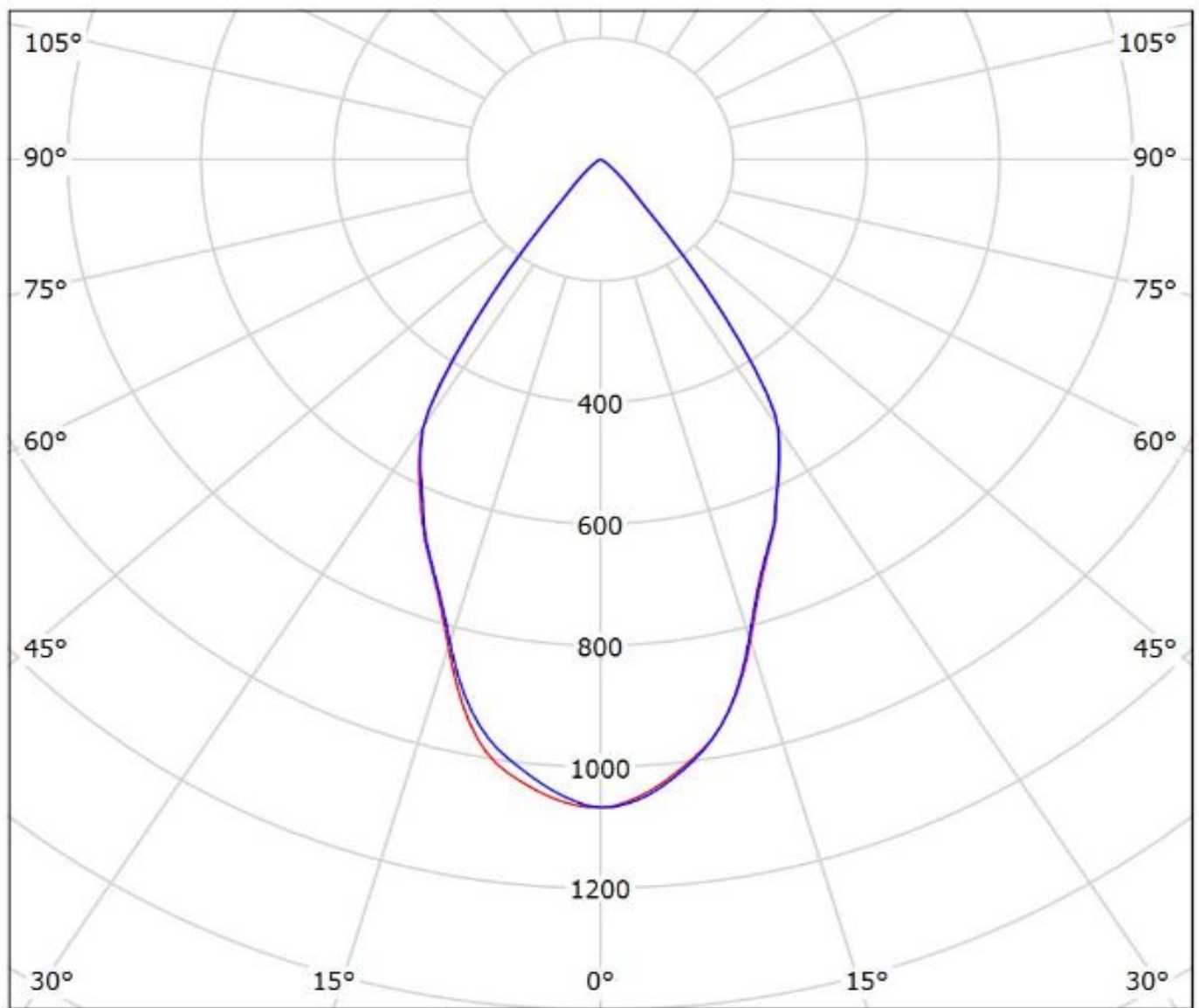

cd/klm
— C0 - C180 — C90 - C270

$\eta = 89\%$

Luminaire: Ledil F14534_ANGELETTE-WW_(CLU036+IDEAL)
Lamps: 1 x CITIZEN_CLU036_(-1208C1-303M2G2)_IDEAL_50-2103CT+50-2100AN_1299.86lm@250mA_CCT=3000K_P=8.249W_I=0.25A

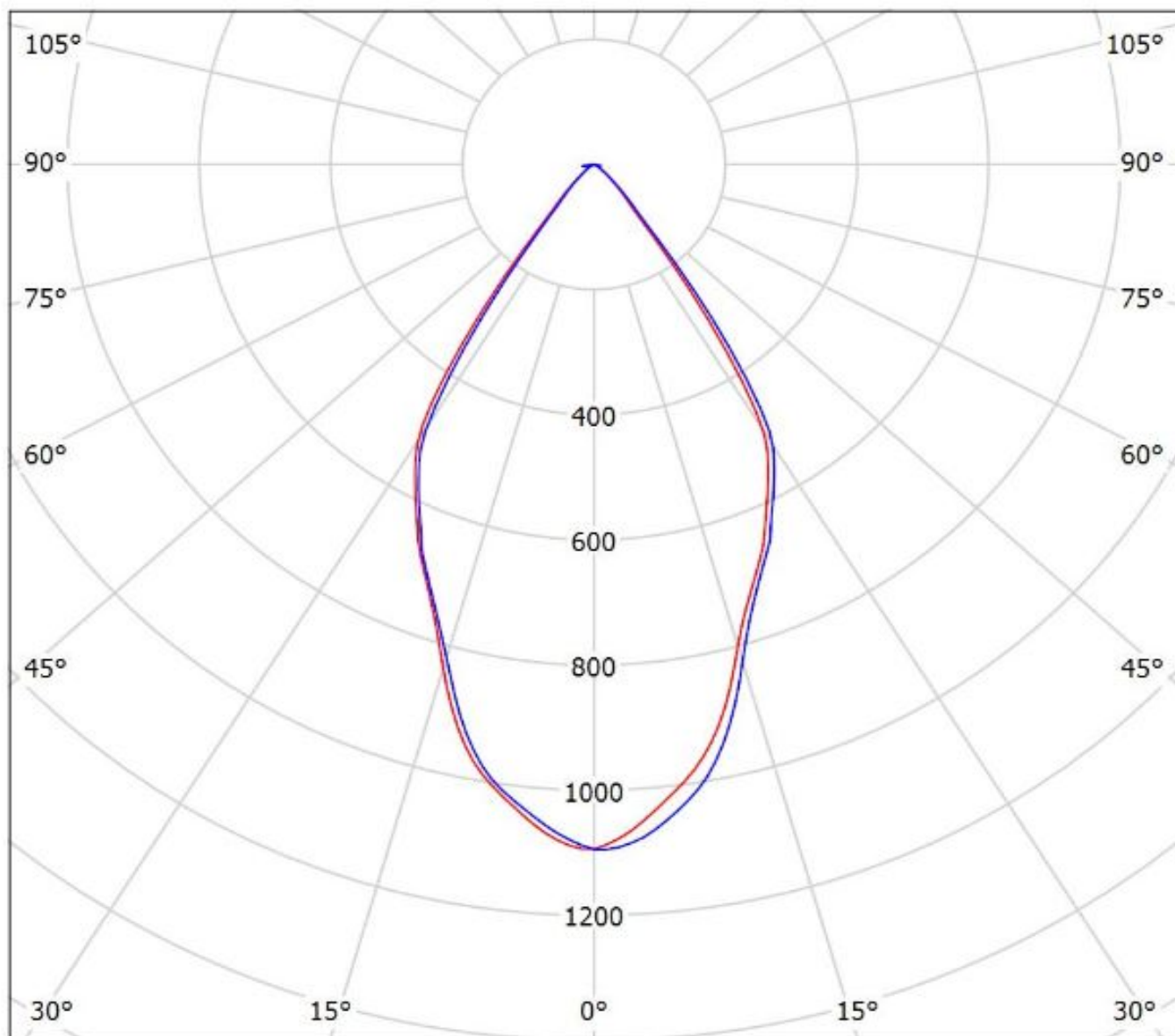

cd/klm

— C0 - C180 — C90 - C270

$\eta = 89\%$

Luminaire: Ledil F14534_ANGELETTE-WW_(CLU730+IDEAL)

Lamps: 1 x Citizen_CLU730_(-1210B8-273M2G1)_IDEAL_50-2204C+50-2100AN

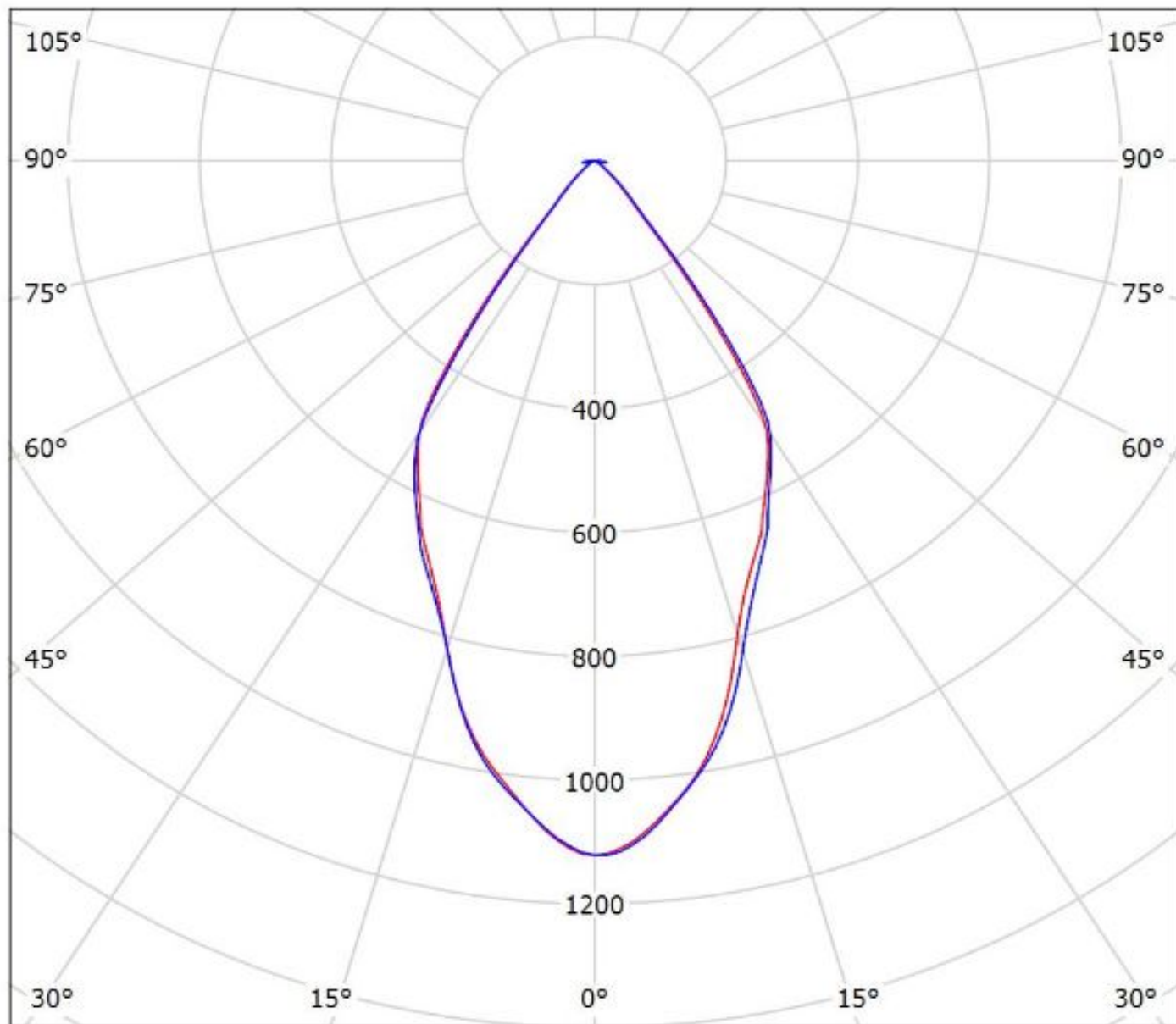

cd/klm

— C0 - C180

— C90 - C270

$\eta = 89\%$

Luminaire: Ledil F14534_ANGELETTE-WW_(CoB1208+IDEAL)
Lamps: 1 x Luxeon_CoB1208_+_50-2100SH+50-
2100AN_1062.11lm@250mA_CCT=3000K_P=8.3007W_I=0.25A

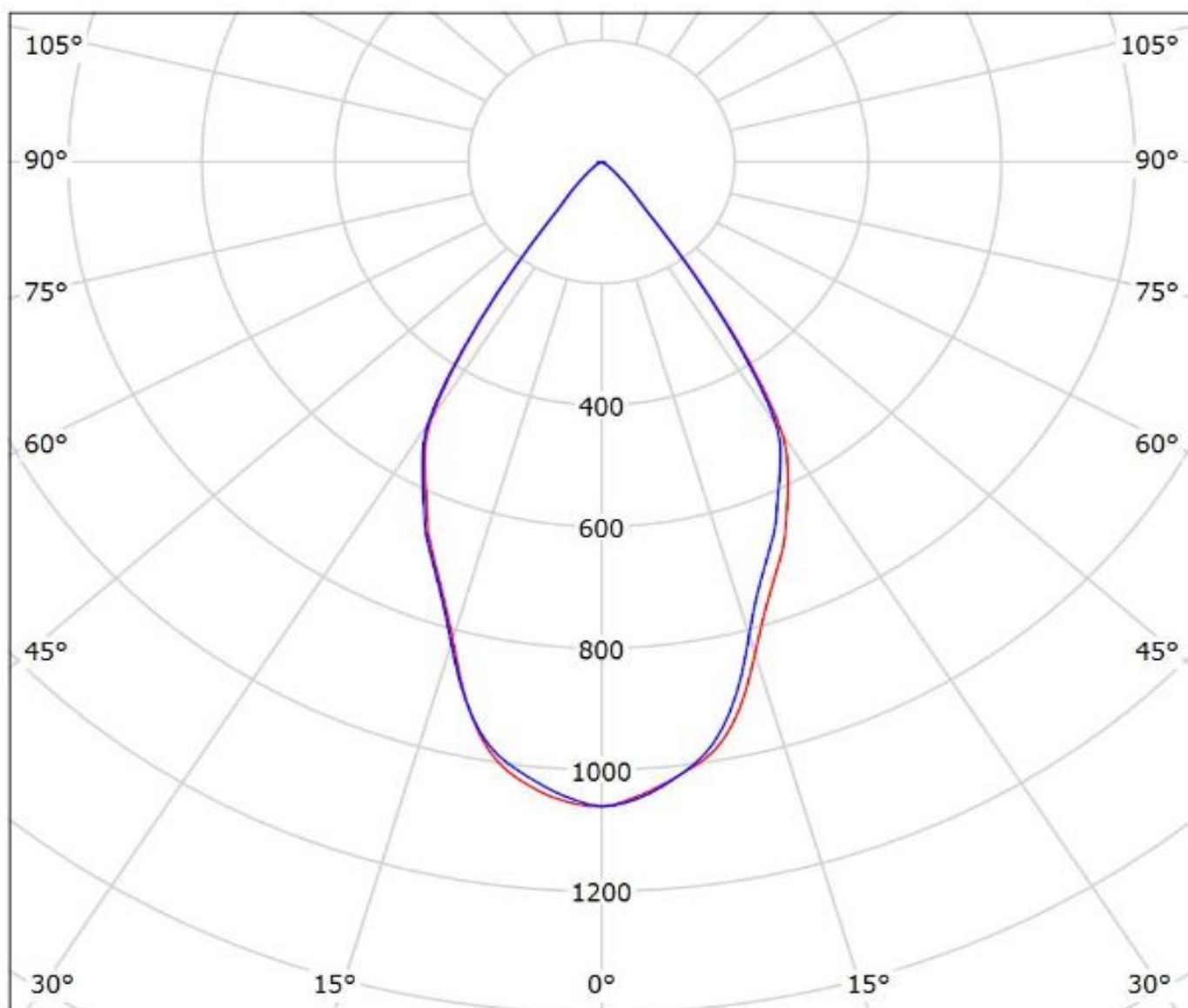

cd/klm

— C0 - C180 — C90 - C270

$\eta = 89\%$

Luminaire: Ledil F14534_ANGELETTE-WW_(CoB1208+TE)
Lamps: 1 x Luxeon_CoB1208_ + 2213130-2_ + 2213194-
1_1062.11lm@250mA_CCT=3000K_P=8.3007W_I=0.25A

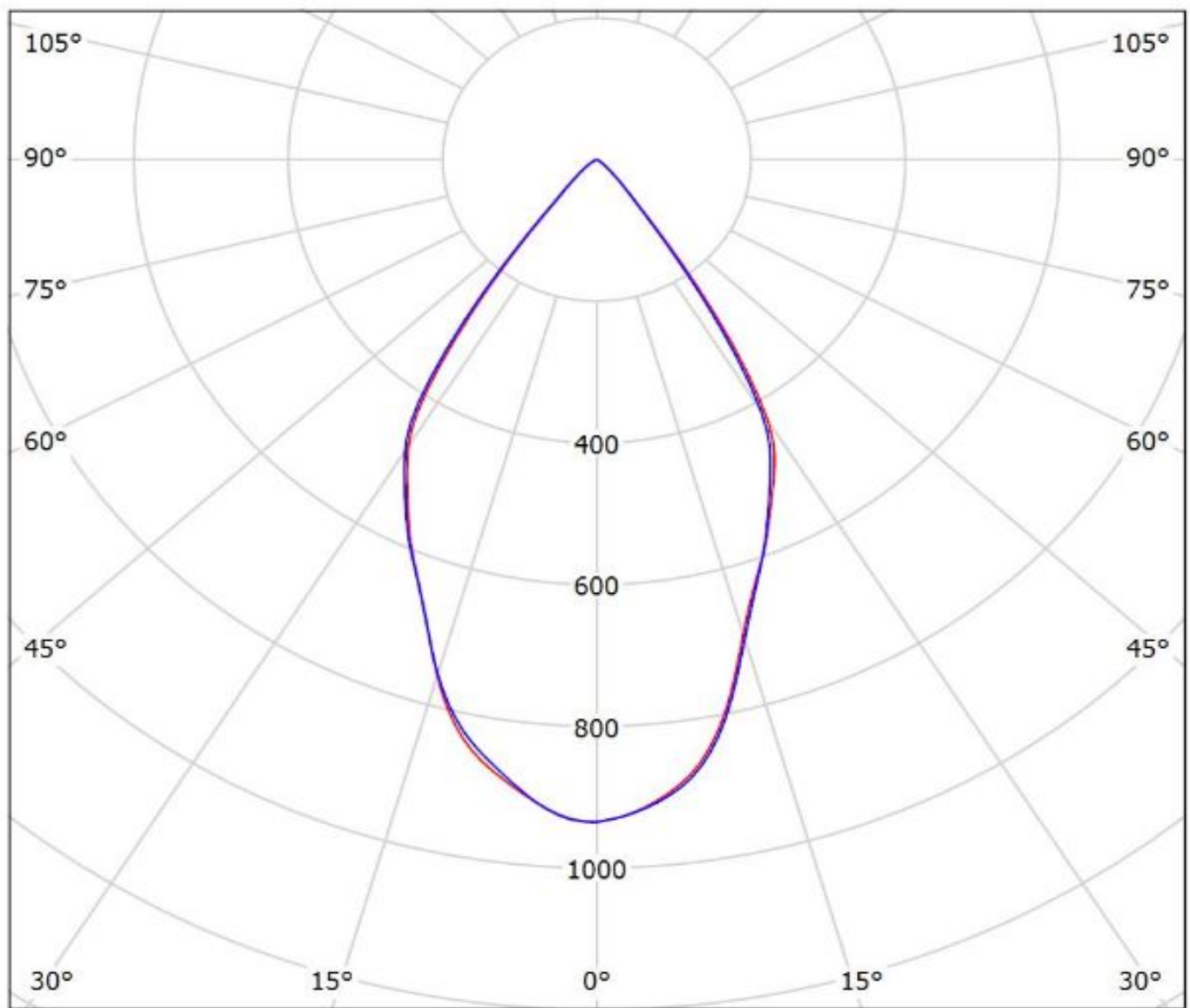

cd/klm
— C0 - C180 — C90 - C270

η = 79%

Luminaire: Ledil F14534_ANGELETTE-WW_(CoB1211+IDEAL)
Lamps: 1 x Luxeon_CoB1211_(L2C2-4080)_50-2204CT+50-2100AN_1376.18lm@250mA_P=7.9988W_I=0.25A

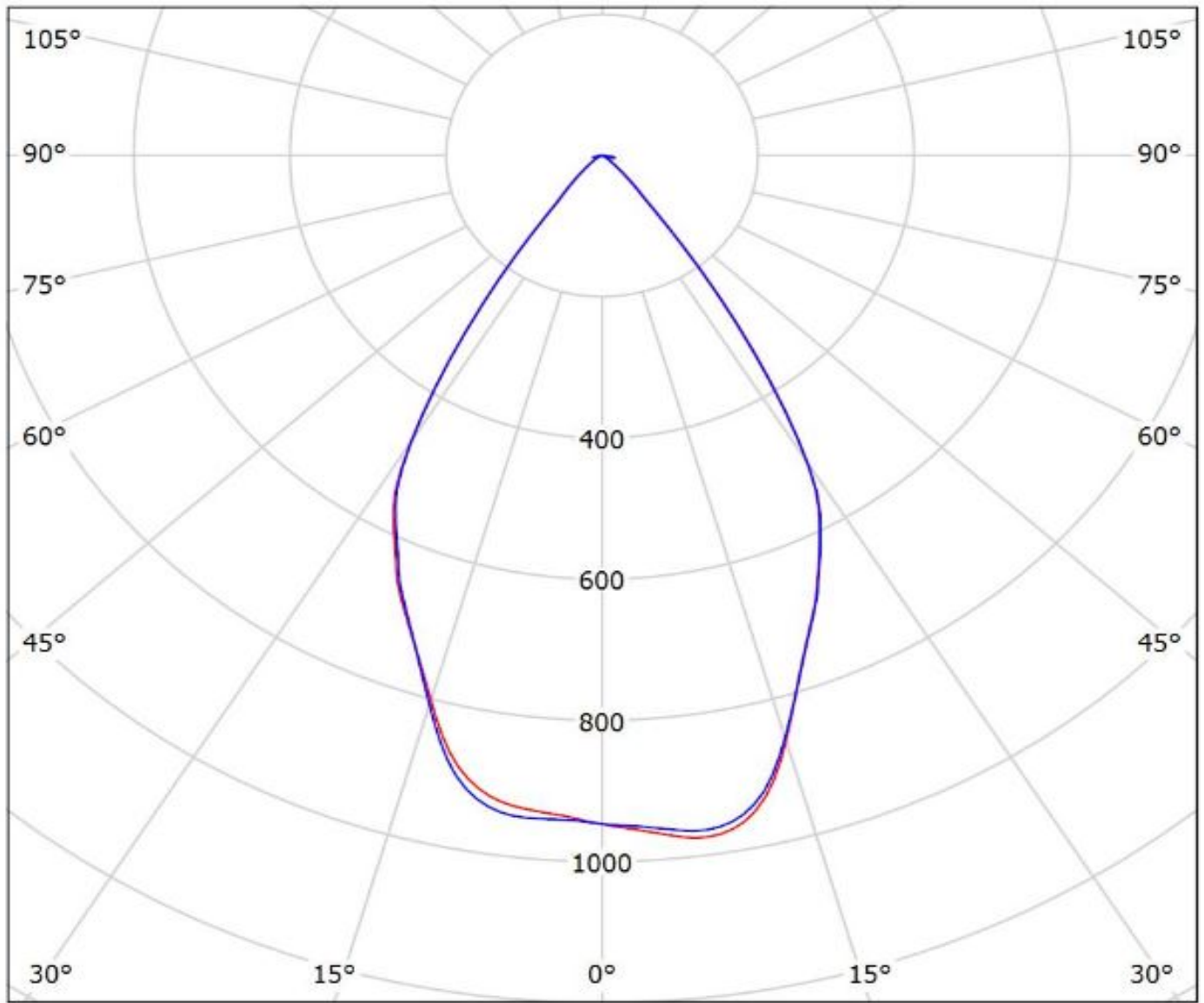

cd/klm
— C0 - C180 — C90 - C270

$\eta = 89\%$

Luminaire: Ledil F14534_ANGELETTE-WW_(CoB1216_IDEAL)
Lamps: 1 x Luxeon_CoB1216_(L2C2-40801216E2300)_+50-2204C_+_50-2100AN_1447.57lm@250mA_CCT=4000K_P=8.0135W_I=0.25A

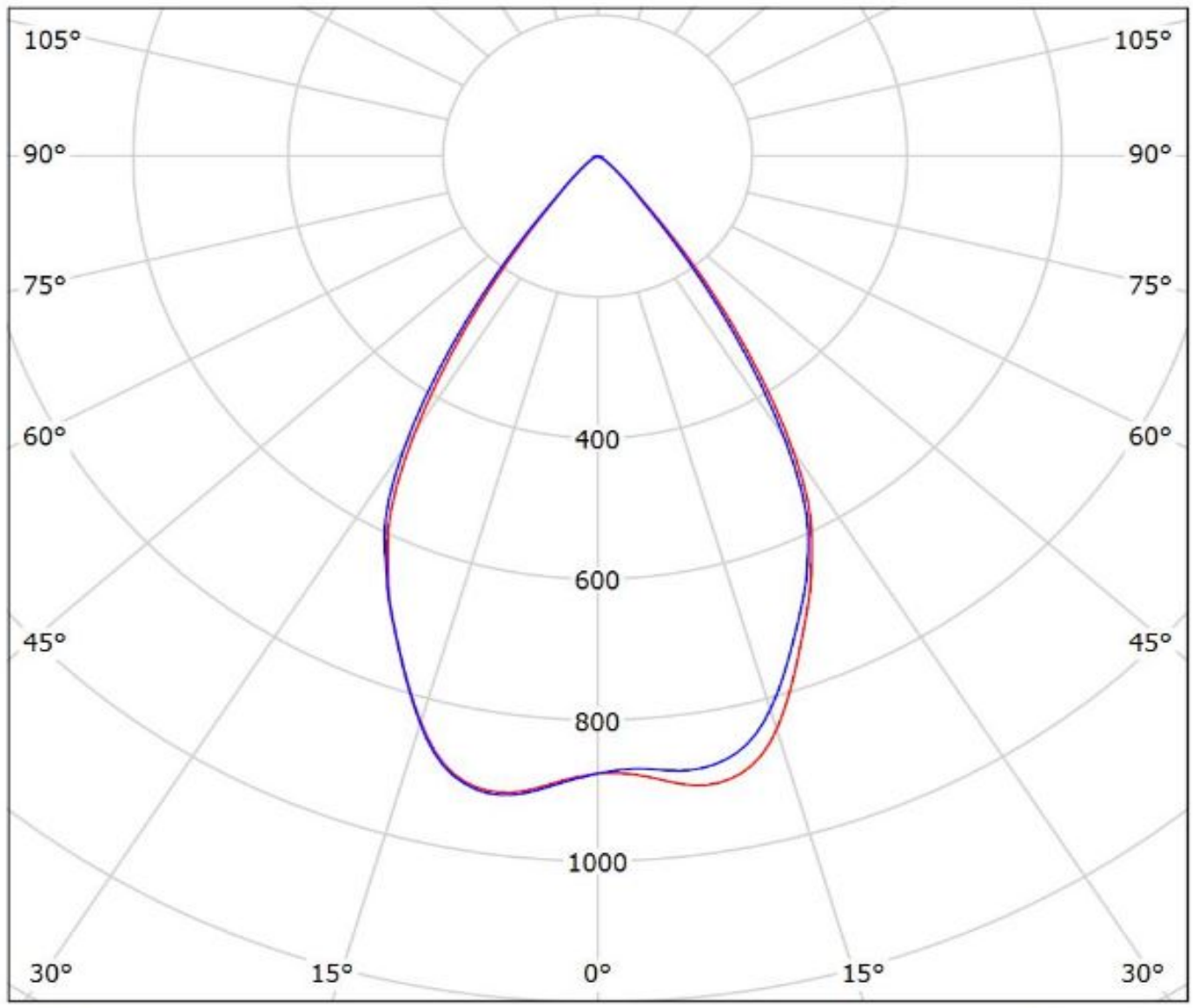

cd/klm
— C0 - C180 — C90 - C270

$\eta = 89\%$

Luminaire: Ledil F14534_ANGELETTE-WW_(NVCLL024Z+IDEAL)

Lamps: 1 x Nichia_NVCxL024z_(NVCLL024z)_975.455lm@250mA_P=8.1468W_I=250A

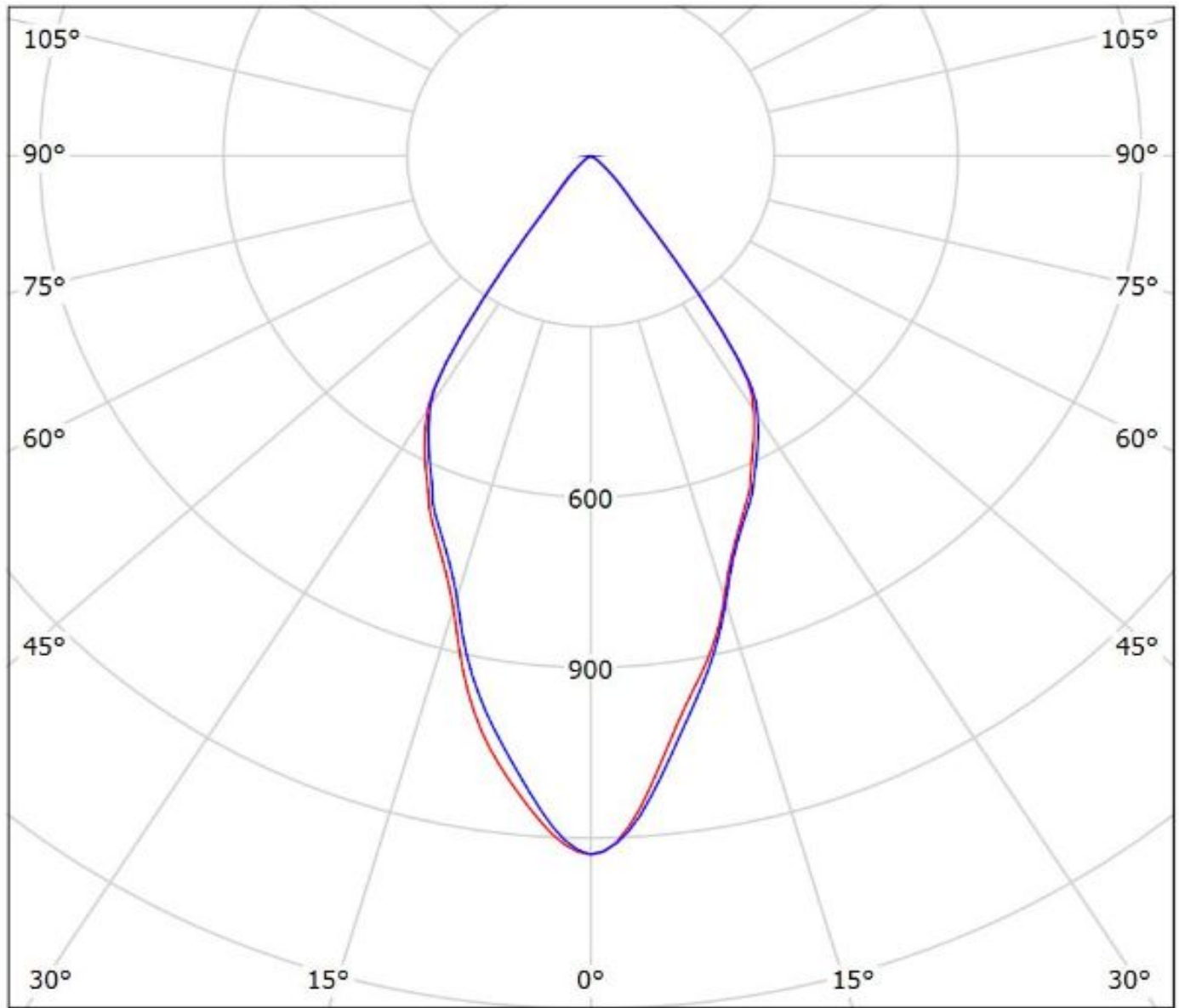

cd/klm

— C0 - C180

— C90 - C270

$\eta = 88\%$

Luminaire: Ledil F14534_ANGELETTE-WW_(NVCLL024Z+TE)
Lamps: 1 x Nichia_NVCLL024Z_+2213382-2_+2213194-
1_971.485lm@250mA_CCT=3000K_P=8W_I=0.25A

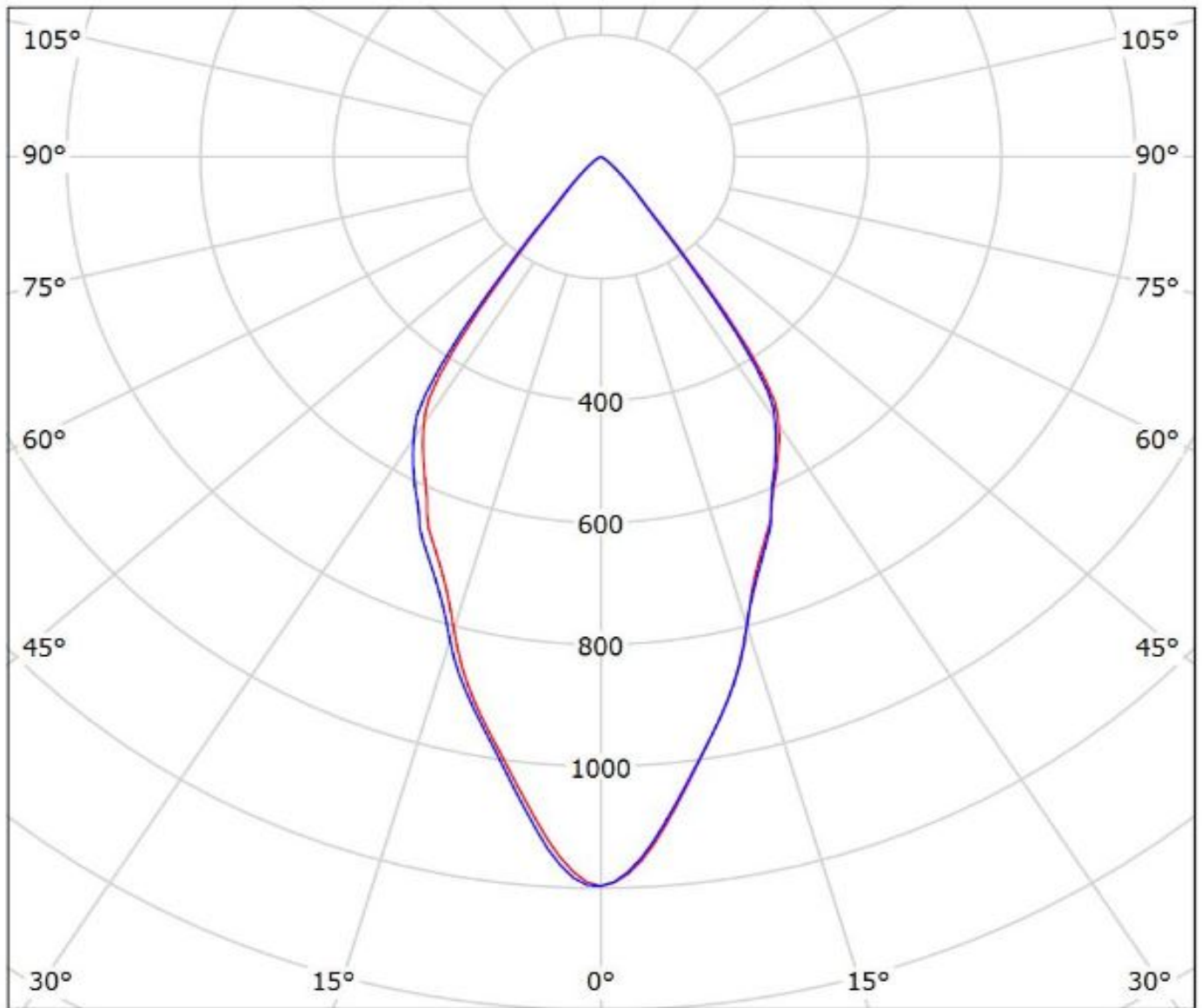

cd/klm

— C0 - C180 — C90 - C270

$\eta = 89\%$

Luminaire: LEDiL Oy F14534_ANGELETTE-WW_(NFDLJ130B+IDEAL)

Lamps: 1 x Nichia_NFDLJ130B_+50-2103NC_+50-2100AN_1422.52lm@250mA_CCT=4000K_P=8.91686W_I=0.25A

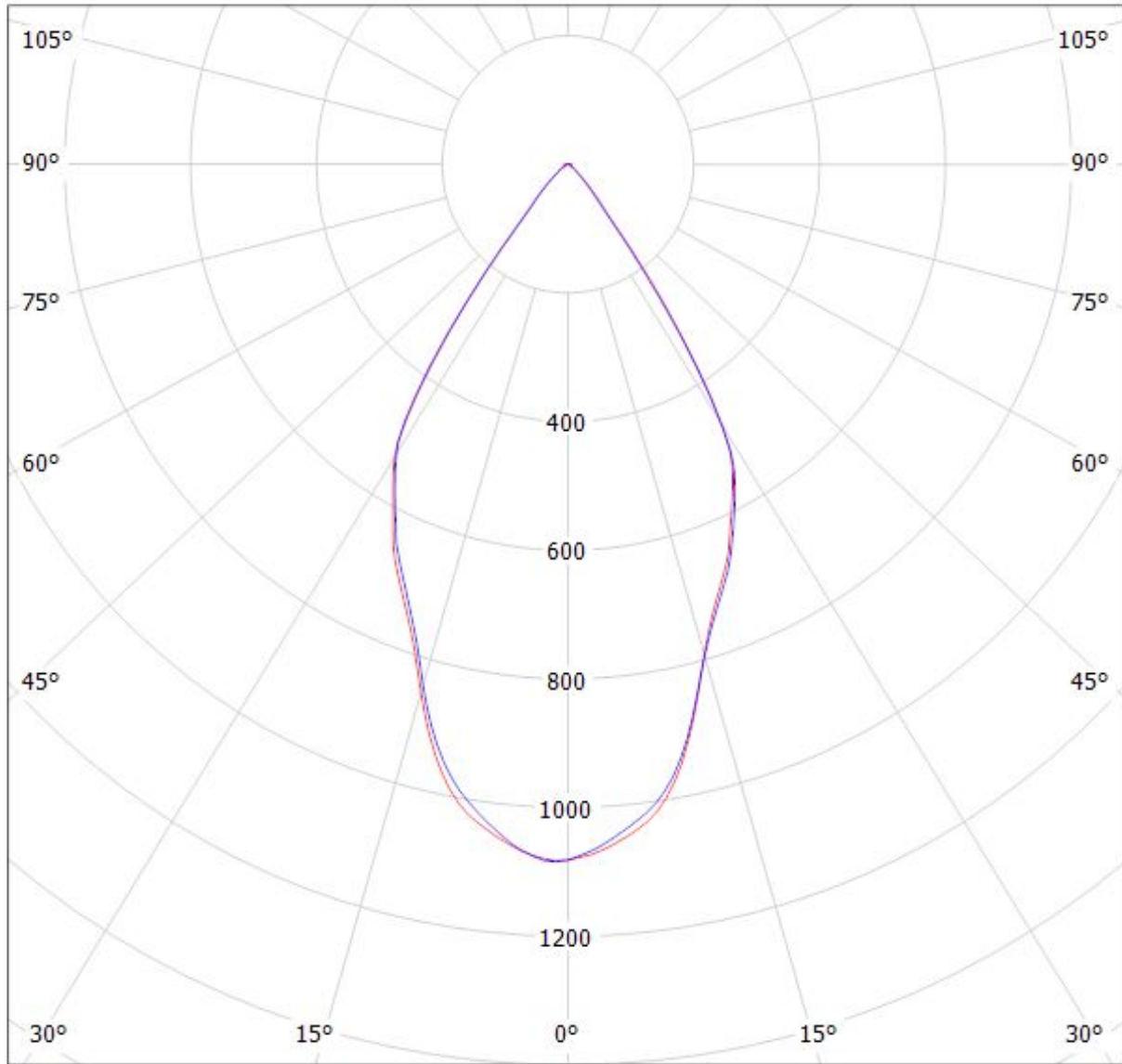

cd/klm

— C0 - C180

— C90 - C270

$\eta = 89\%$

Luminaire: Ledil F14534_ANGELETTE-WW_(PREVALED_Core_Z4)

Lamps: 1 x PREVALED_Core_Z4_LES19_1470.62lm@250mA_P=10.828W_I=0.25A

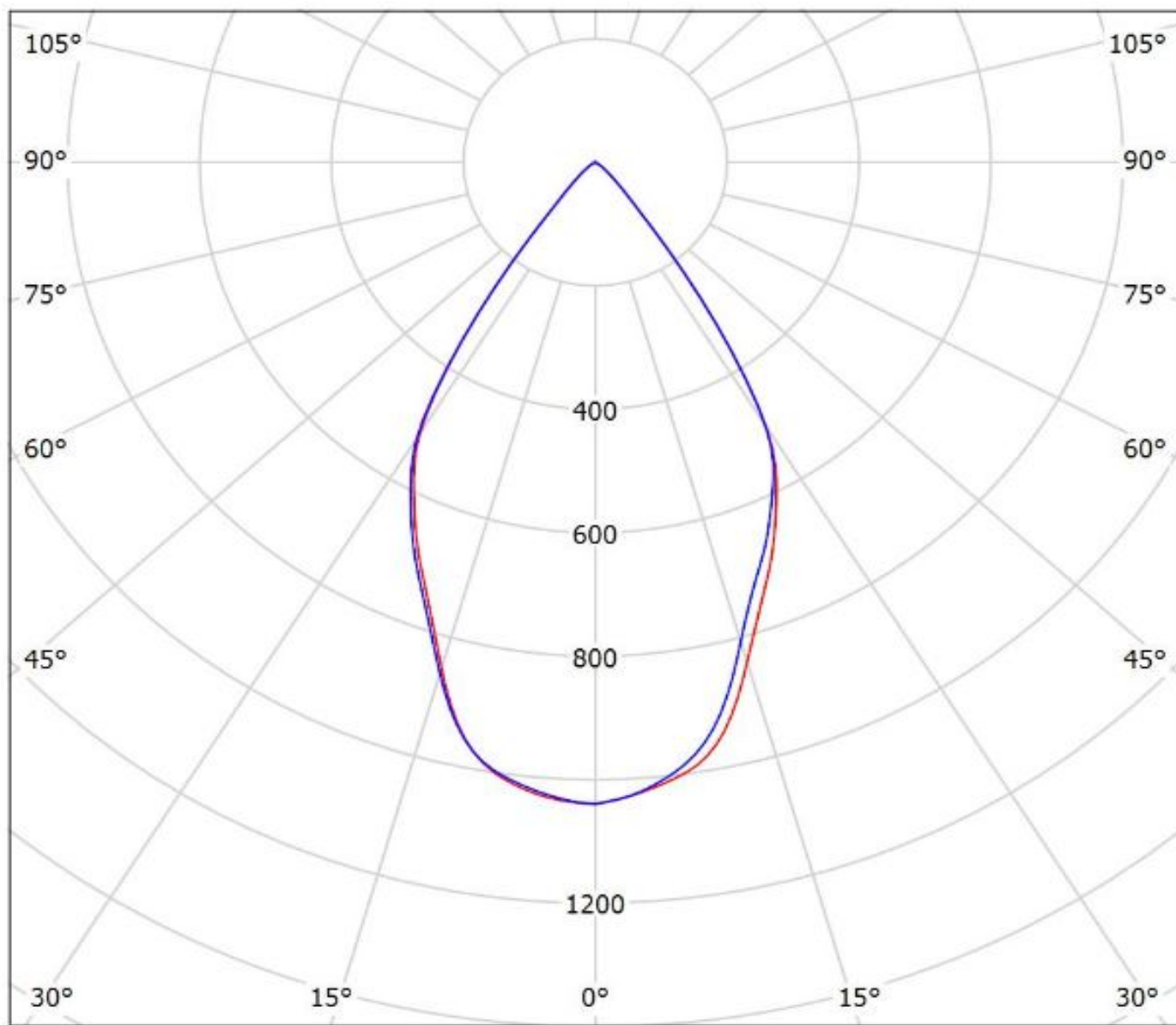

cd/klm

— C0 - C180 — C90 - C270

$\eta = 89\%$

Luminaire: Ledil F14534_ANGELETTE-WW_(S19+TE)

Lamps: 1 x Osram_Soleriq_S19_(GW_KAHJB1.EM)_+2213407-2+2213194-

1_1546.1lm@250mA_CCT=3000K_P=11.021W_I=0.25A

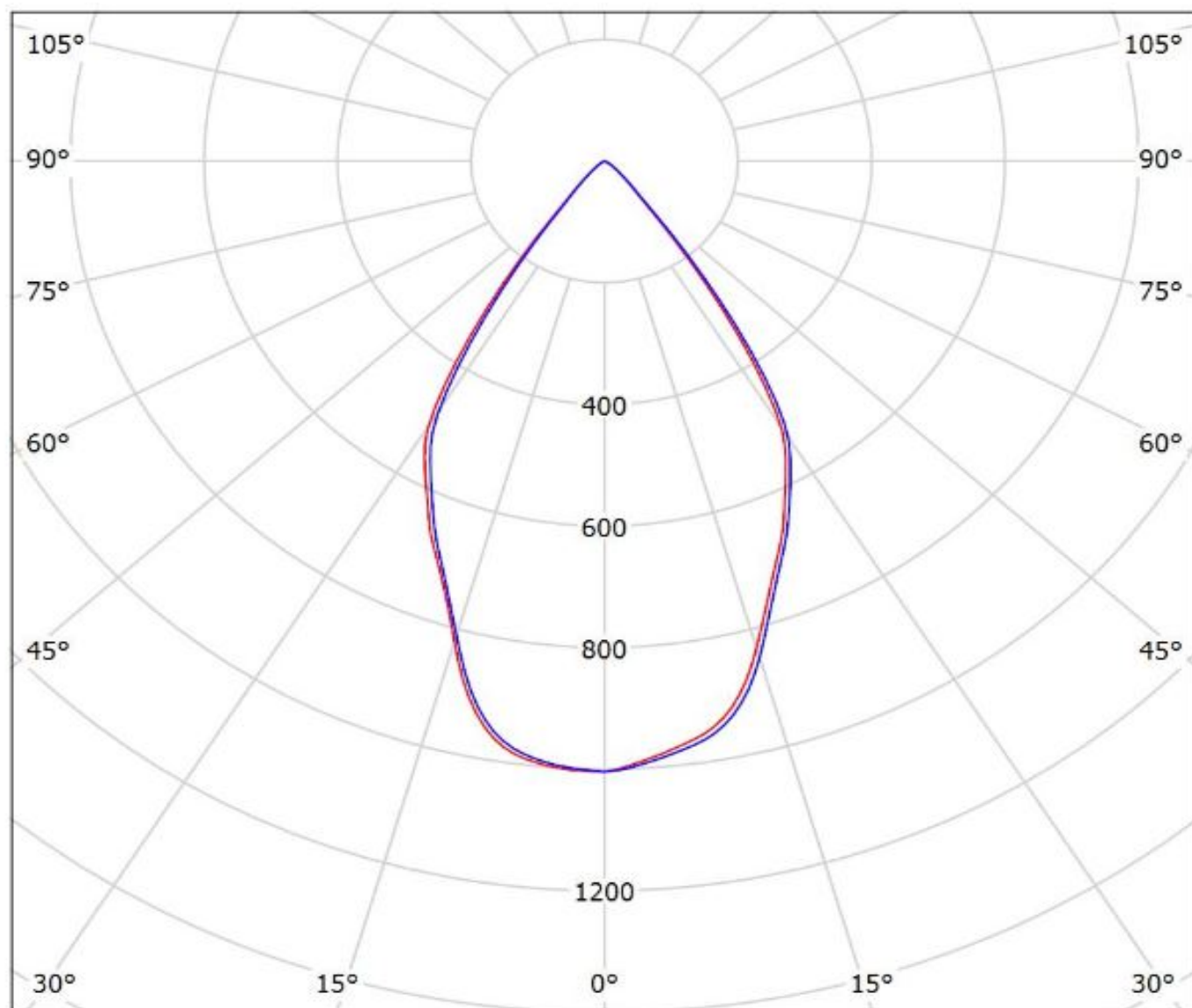

cd/klm

— C0 - C180 — C90 - C270

$\eta = 89\%$

Luminaire: Ledil F14534_ ANGELETTE-WWW_(S13_Gen2+TE)

Lamps: 1 x Soleriq_S13_Gen2+_2213254-2+_2213194-1_1309.23lm@250mA_P=8.7840W_I=0.250A

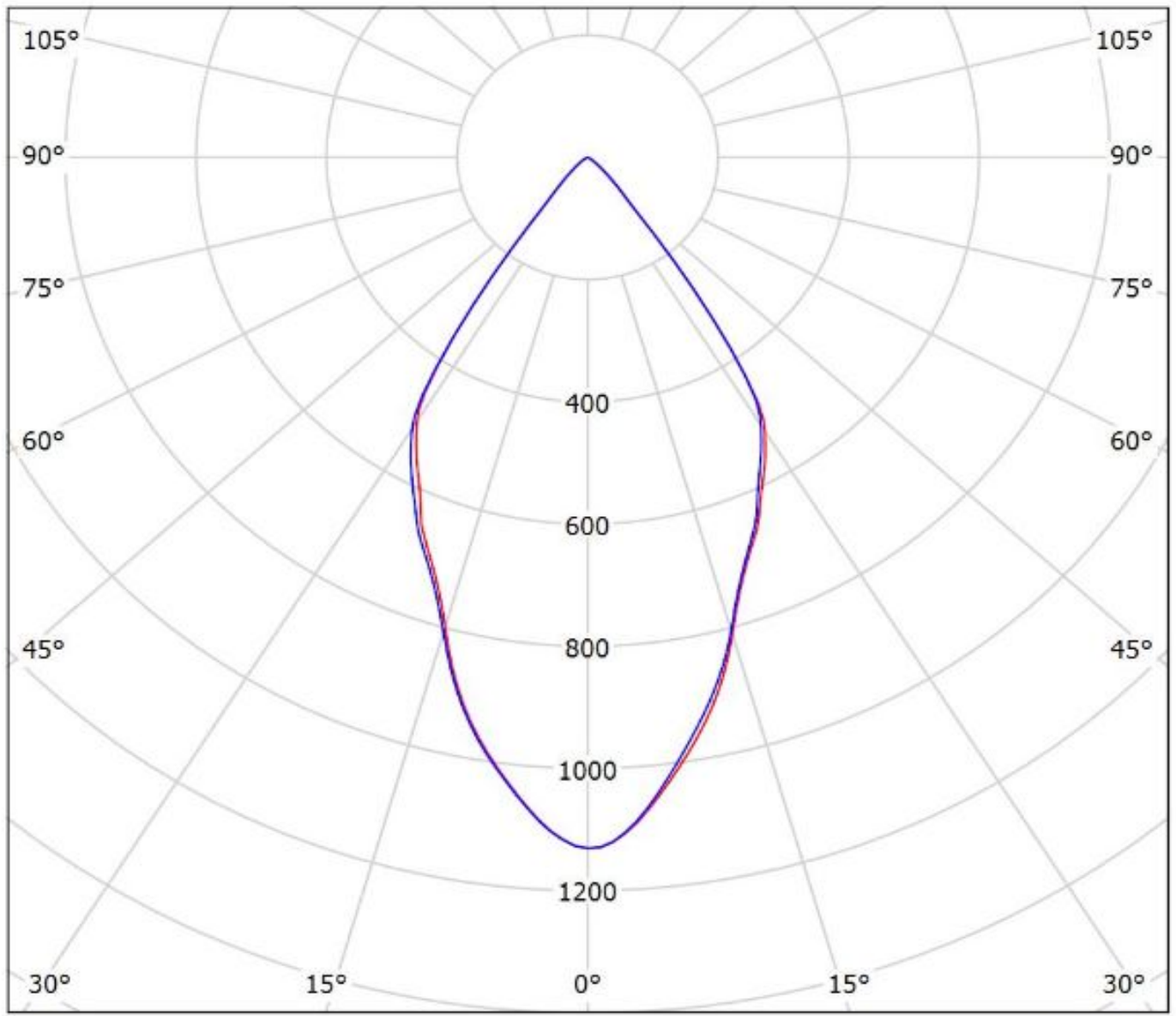

cd/klm

— C0 - C180 — C90 - C270

$\eta = 89\%$

Luminaire: Ledil F14534_ANGELETTE-WW_(S13_Gen2+IDEAL)

Lamps: 1 x Soleriq_S13_Gen2+_50-2103CT+_50-2100AN_1327.38lm@250mA_P=8.7850W_I=0.250A

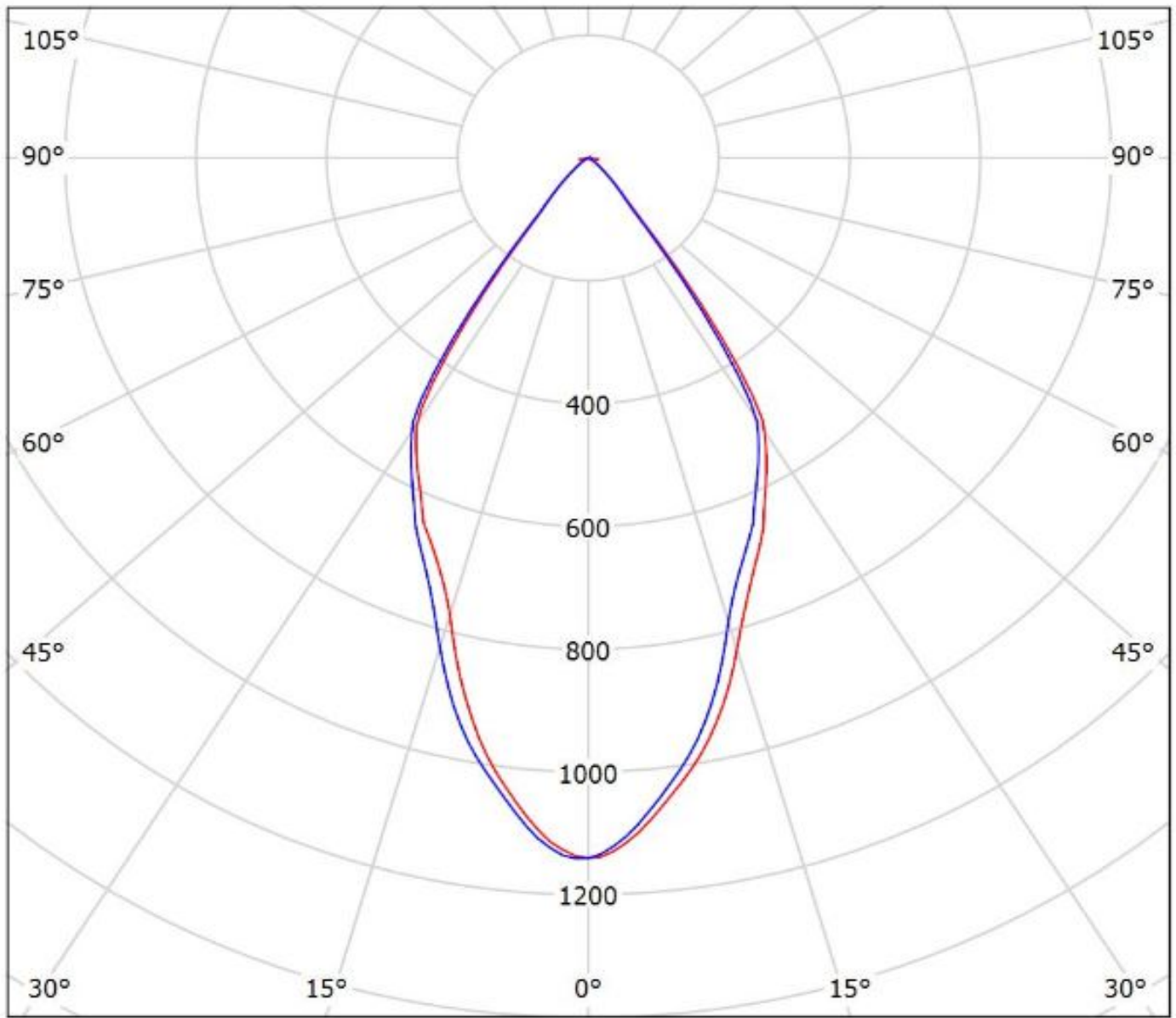

cd/klm

— C0 - C180 — C90 - C270

$\eta = 88\%$

Luminaire: Ledil F14534_ANGELETTE-WW_(SLM_G5_LES_15_+TE)

Lamps: 1 x Philips_SLM_G5_LES_15_+TE_2213194-1_1277.72lm@250mA_P=8.208W_I=0.25A

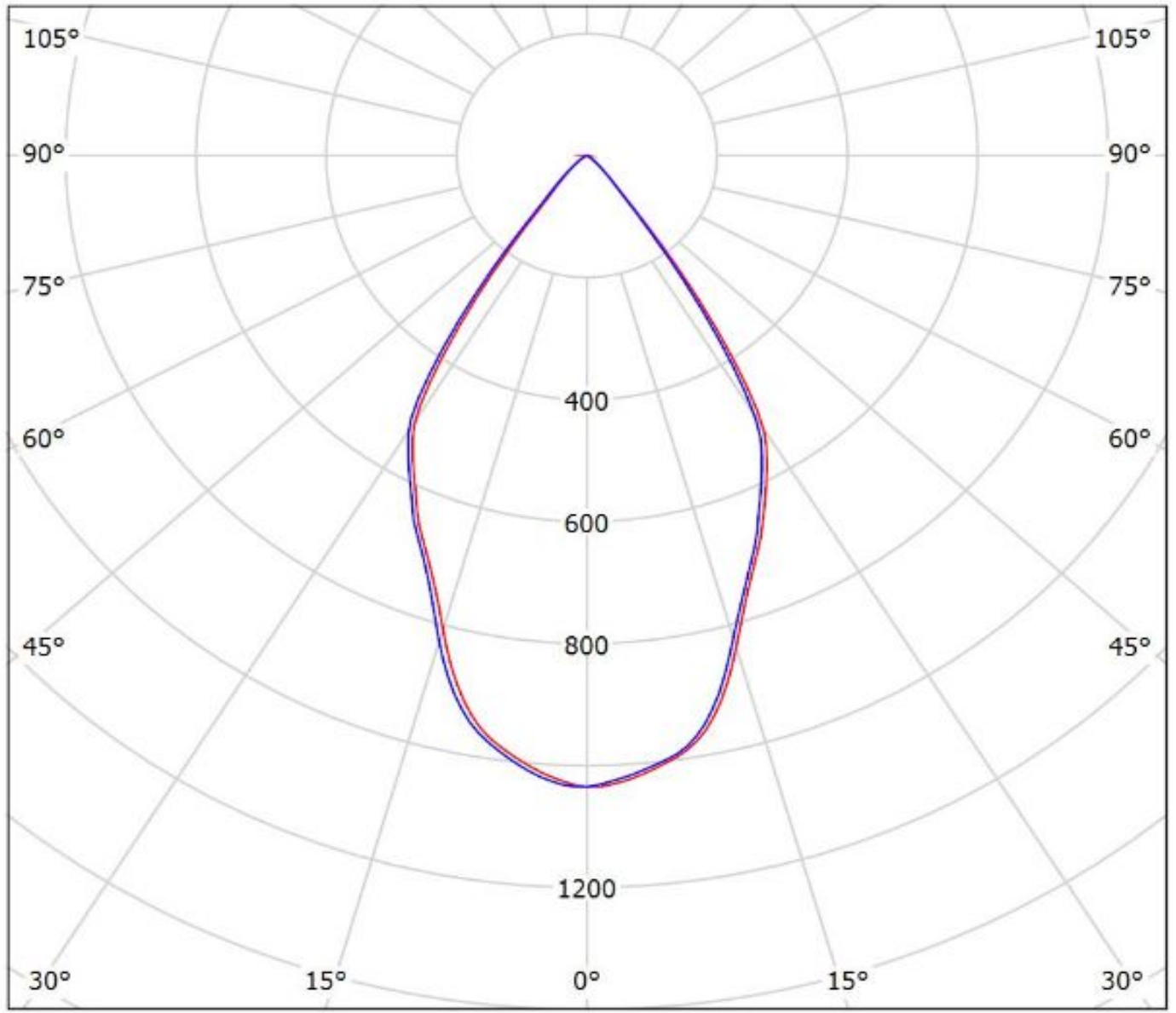

cd/klm

— C0 - C180 — C90 - C270

$\eta = 89\%$

Luminaire: Ledil F14534_ANGELETTE-WW_(LC040C+TE)

Lamps: 1 x Samsung_LC040C+_2213382-2+_2213194-1_1194.16lm@250mA_CCT=4000K_P=8.137W

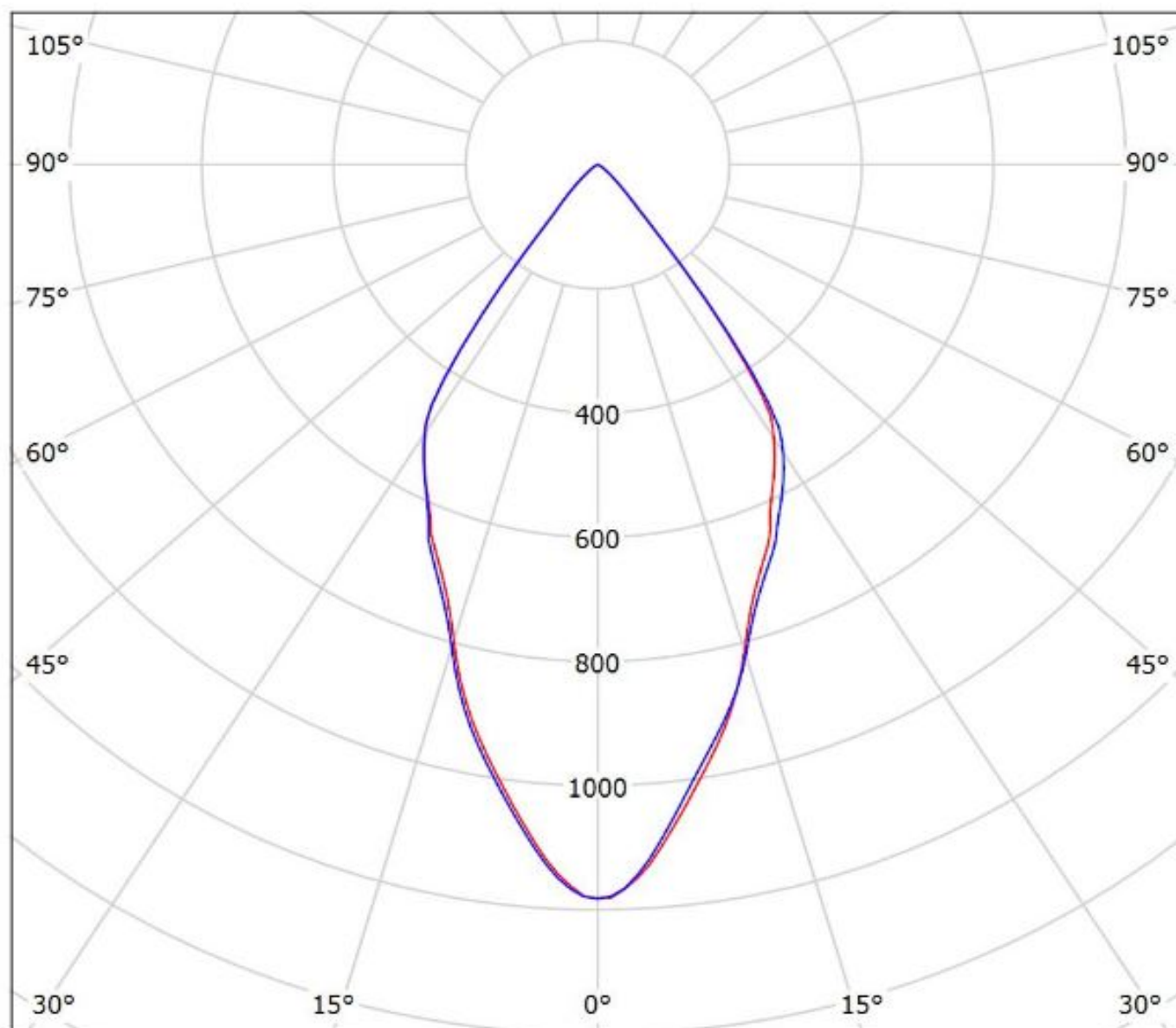

cd/klm

— C0 - C180 — C90 - C270

$\eta = 89\%$

Luminaire: Ledil F14534_ANGELETTE-WW_(SEOUL_AC_Zhaga_COB)
Lamps: 1 x SEOUL_AC_Zhaga_COB

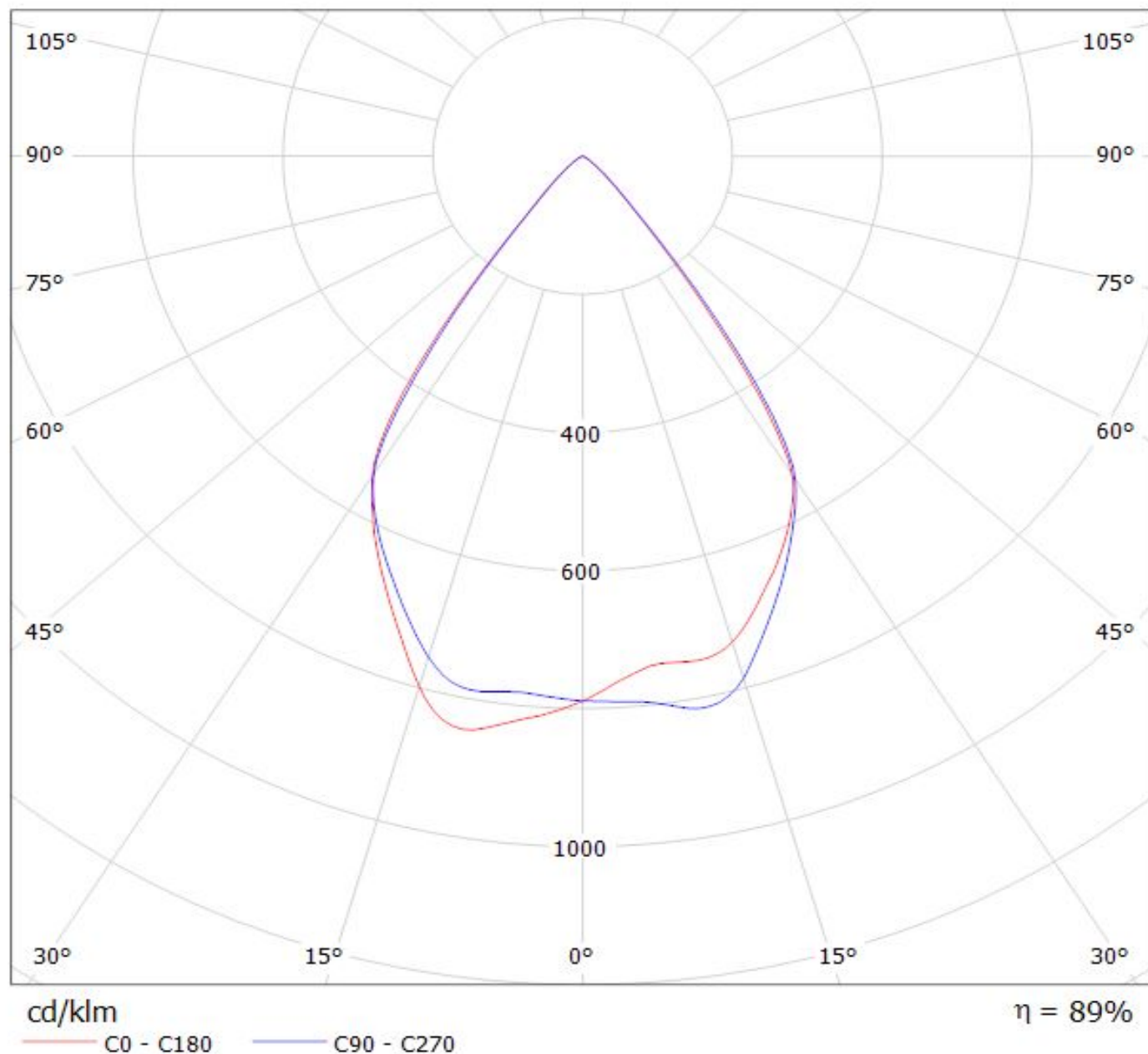

Luminaire: Ledil F14534_ANGELETTE-WW_(MJT_30W_Les14,5)_TE

Lamps: 1 x Seoul_MJT_30W_Les14,5mm_(SAWx1566A)_+TE_2213254-2_+_TE_2213194-1_1328.6lm@250mA_P=8.24025W_I=0.25A

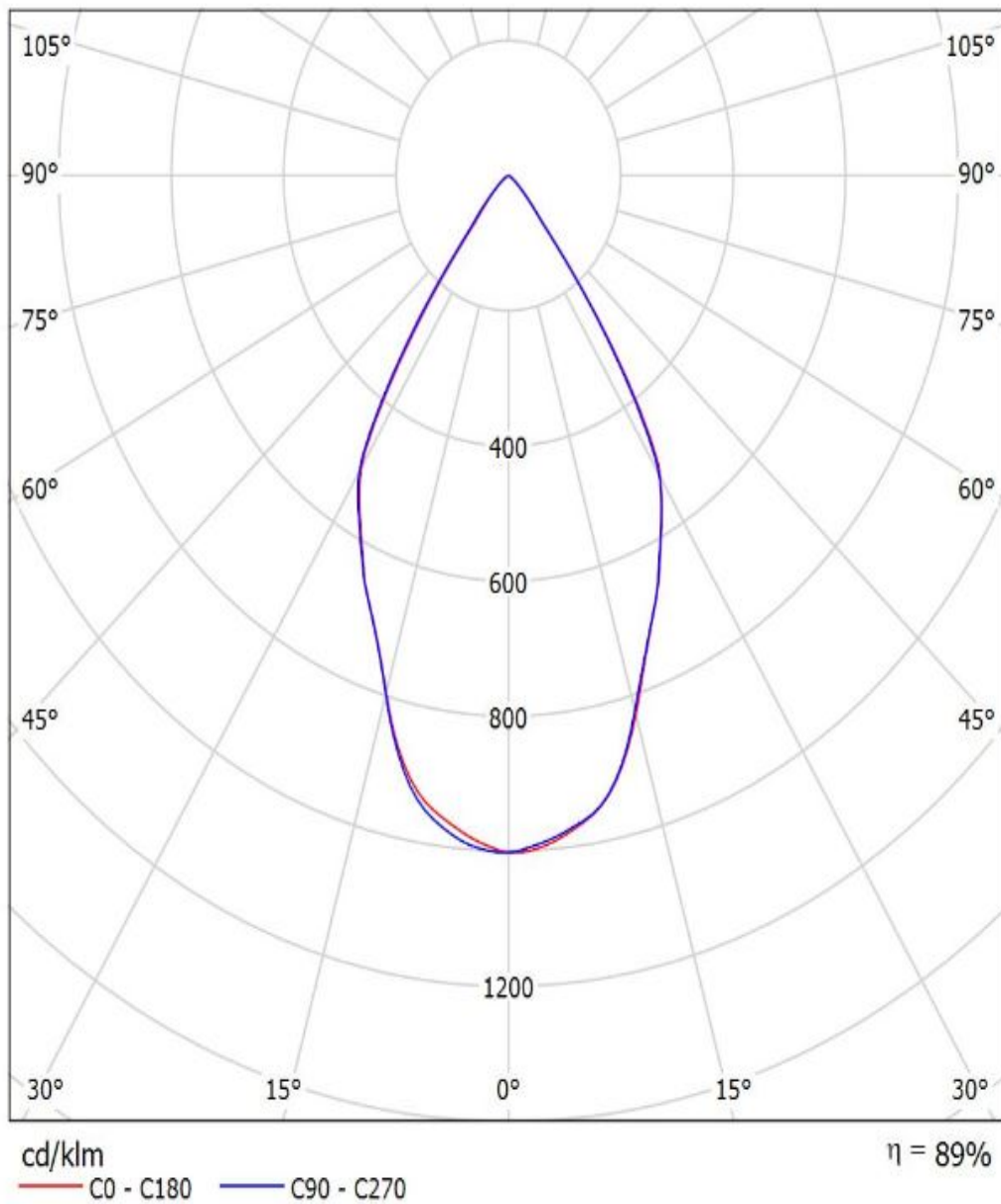

Luminaire: Ledil Oy F14534_ANGELETTE-WW_(SLE_G6_LES15)_(2213254-2+_2213194-1)
_SIMULATED

Lamps: 1 x Tridonic SLE G6 LES15 + Tyco Electronics 2213254-2 + TE 2213194-1 Optic clip

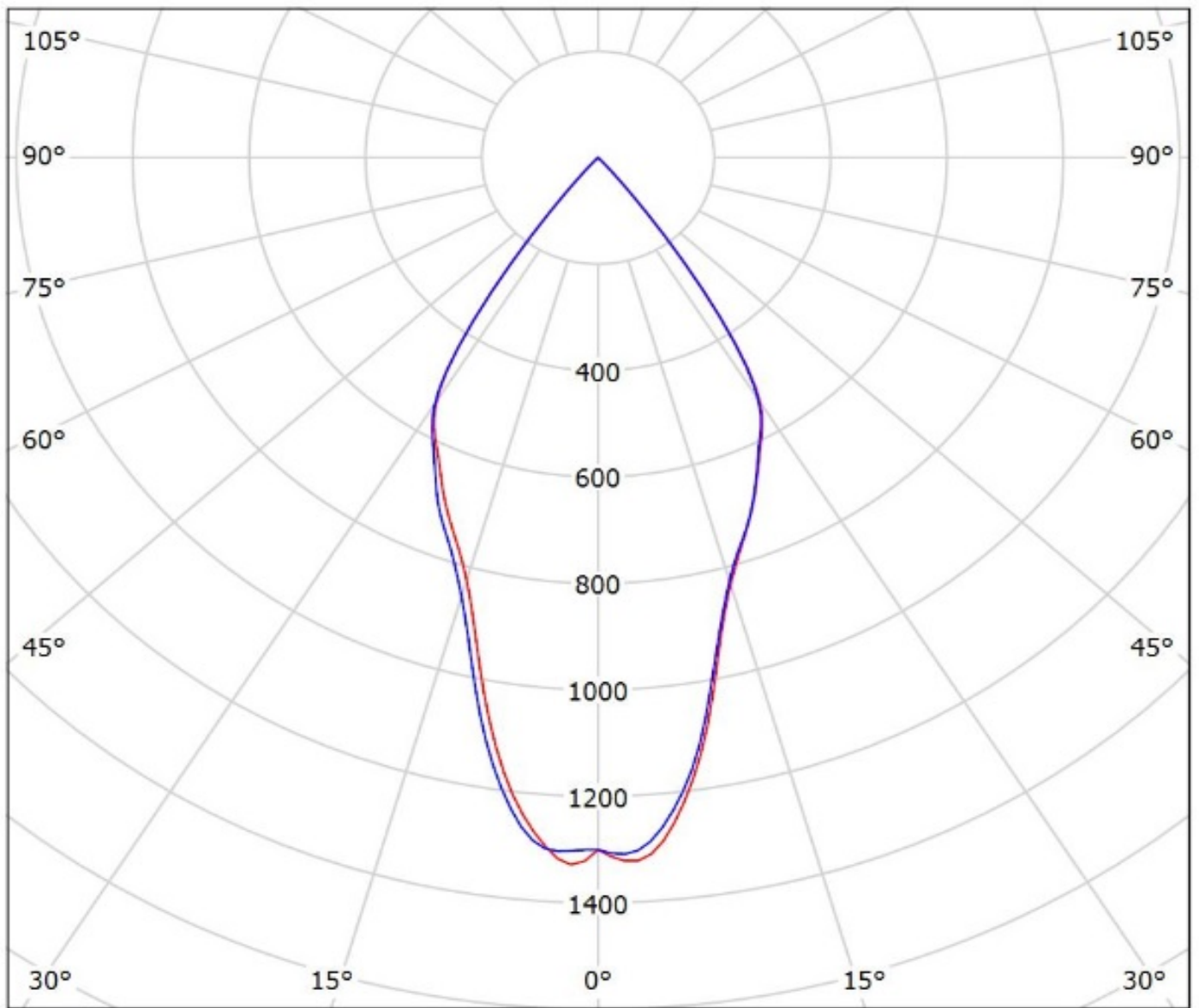

cd/klm

— C0 - C180 — C90 - C270

$\eta = 89\%$

Luminaire: Ledil Oy F14534_ANGELETTE-WW+_TE_2213254-2+_TE_Z50_Type1_TRIDONIC_SLE_G6_LES17_SIMULATED
Lamps: 1 x TRIDONIC SLE G6 LES17

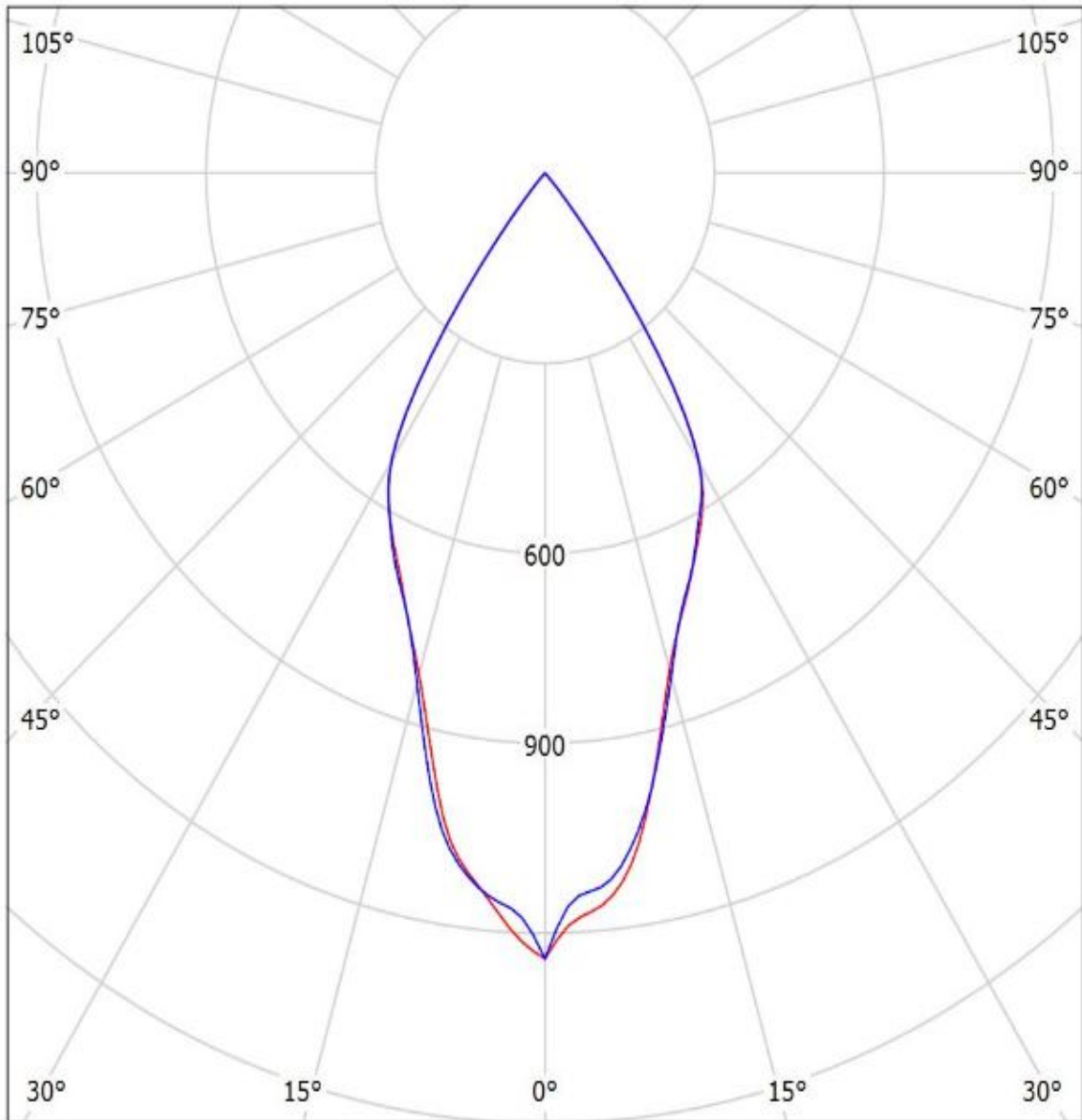

cd/klm

— C0 - C180 — C90 - C270

$\eta = 86\%$

Luminaire: Ledil F14534_ANGELETTE-WW_(WU-M-484+TE)

Lamps: 1 x Vossloh_Schwabe_WU-M-484-830_681.21lm@250mA_P=5.6195W_I=0.25A

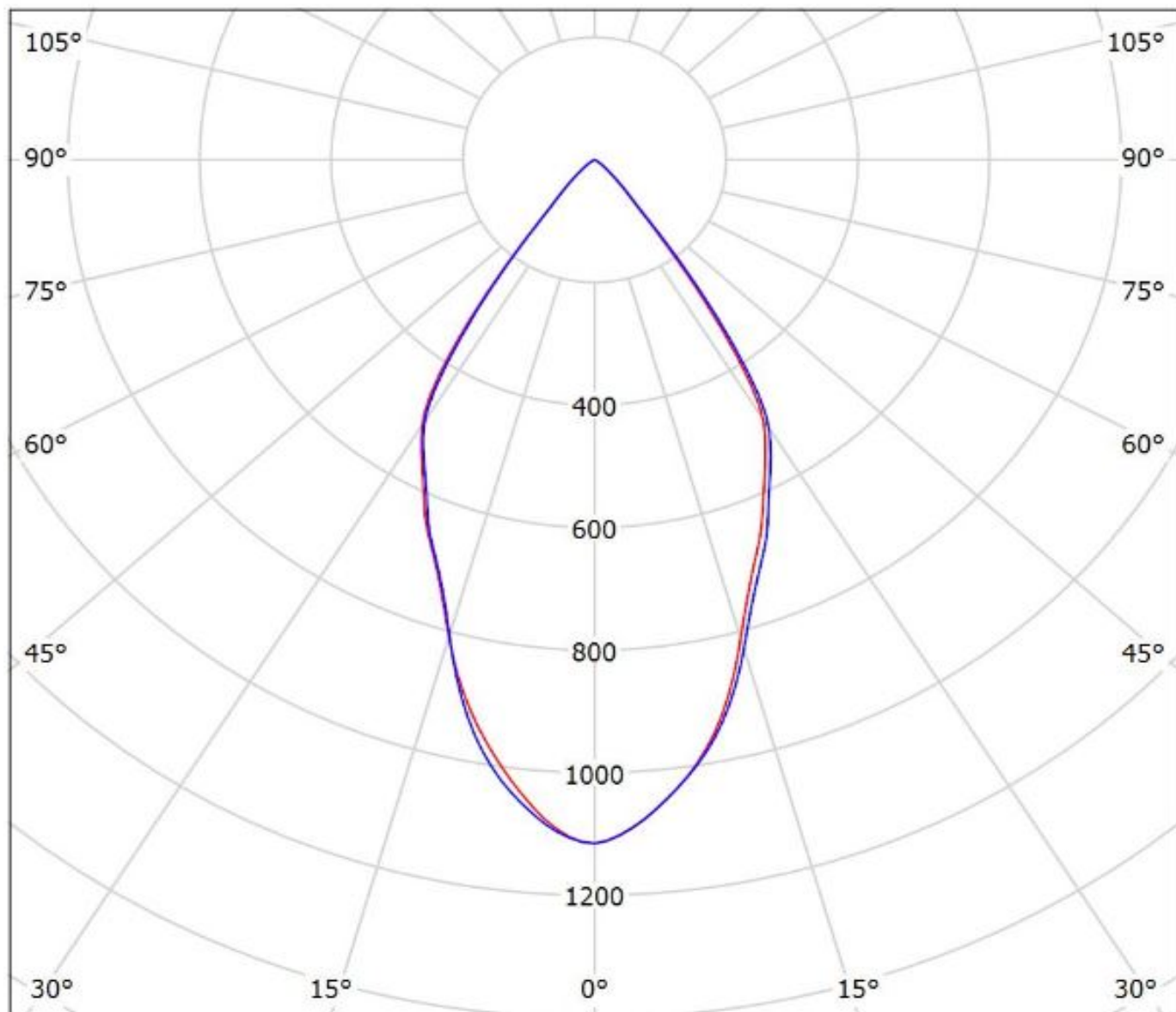

cd/klm

— C0 - C180 — C90 - C270

$\eta = 89\%$

NOTE: The typical divergence will be changed by different color, chip size and chip position tolerance. The typical total divergence is the full angle measured where the luminous intensity is half of the peak value.

GENERAL INFORMATION

- Product series especially designed & optimized for series of LEDs.
- Special care taken to make light distribution as uniform as possible.

Note! Due to use of high power COB's with this product, special attention to proper thermal design is highly recommended. LEDiL has no liability for direct, indirect or consecutive damages arising from the LEDiL products being used outside of the recommended temperature range.