

QT-Brightek Side View LED Series

0602 Side View LED

Part No.: QBLP617-S1

Product: QBL617-S1	Date: September 18, 2014	Page 1 of 9
	Version# 1.0	

Table of Contents:

Introduction	3
Electrical / Optical Characteristic (Ta=25 °C)	4
Absolute Maximum Rating	4
Characteristic Curves.....	5
Solder Profile & Footprint.....	6
Packing	7
Labeling	8
Ordering Information	8
Revision History	9
Disclaimer	9

Introduction

Feature:

- Water clear lens
- Package in tape and reel
- Side View Ultra bright 0602 LED package
- AlGaAs technology
- 140° Viewing Angle

Description:

These ultra bright side view 0602 LEDs have a height profile of 0.6mm. With higher packing density and smaller footprint, these LEDs are ideal for smaller equipment and miniature application.

Application:

- Status indication
- Back lighting application
- General Use

Certification & Compliance:

- TS16949
- ISO9001
- RoHS Compliant



Dimension:

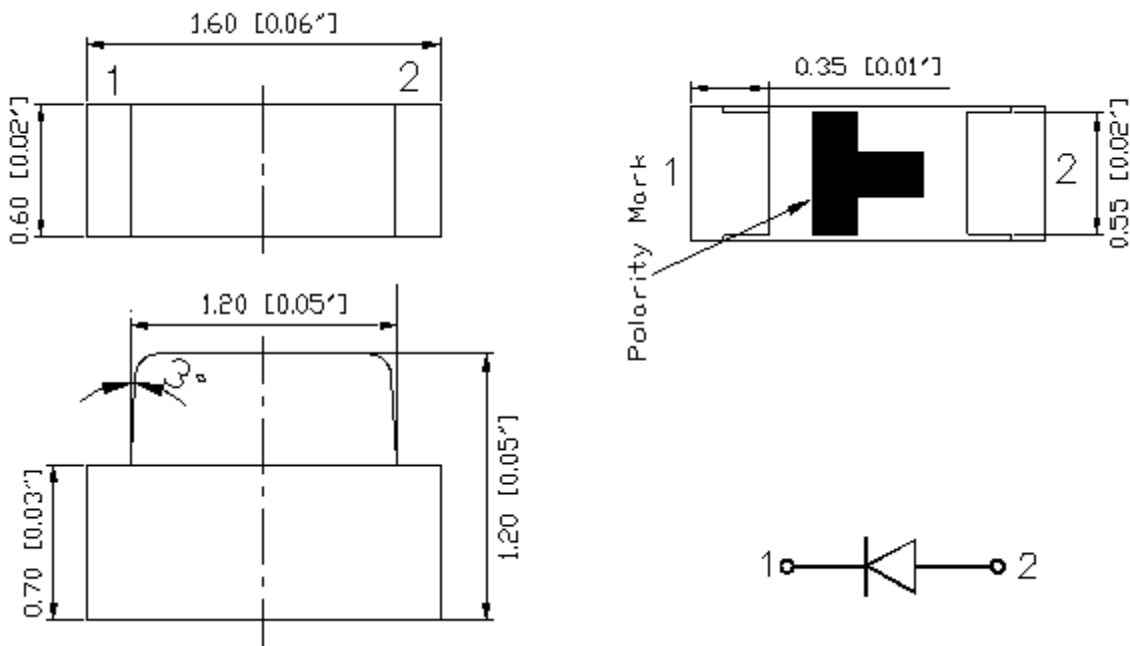

Units: mm / tolerance = +/-0.1mm

Electrical / Optical Characteristic (Ta=25 °C)

Product	Color	I _F (mA)	V _F (V)		λ _D (nm)			I _V (mcd)	
			Typ.	Max.	Min.	Typ.	Max.	Min.	Typ.
QBLP617-S1	Deep Red	20	2.0	2.5	635	640	650	3.2	12

Absolute Maximum Rating

Material	P _d (mW)	I _F (mA)	I _{FP} (mA)*	V _R (V)	T _{OP} (°C)	T _{ST} (°C)	T _{SO L} (°C)**
AlGaAs	75	30	125	5	-40 to +80	-40 to +85	260

*Duty 1/8 @ 1kHz

**IR Reflow for no more than 10 sec @ 260 °C

Forward Voltage V_F @ I_F=20mA

Bin	Min.	Max.	Unit
□	1.7	2.5	V

Luminous Intensity I_V @ I_F=20mA

Bin	Min.	Max.	Unit
7	3.2	5.0	mcd
8	5.0	8.0	
9	8.0	12.5	
A	12.5	16	
B	16	20	

Dominant Wavelength λ_D @ I_F=20mA

Bin	Min.	Max.	Unit
w	635	650	nm

Characteristic Curves

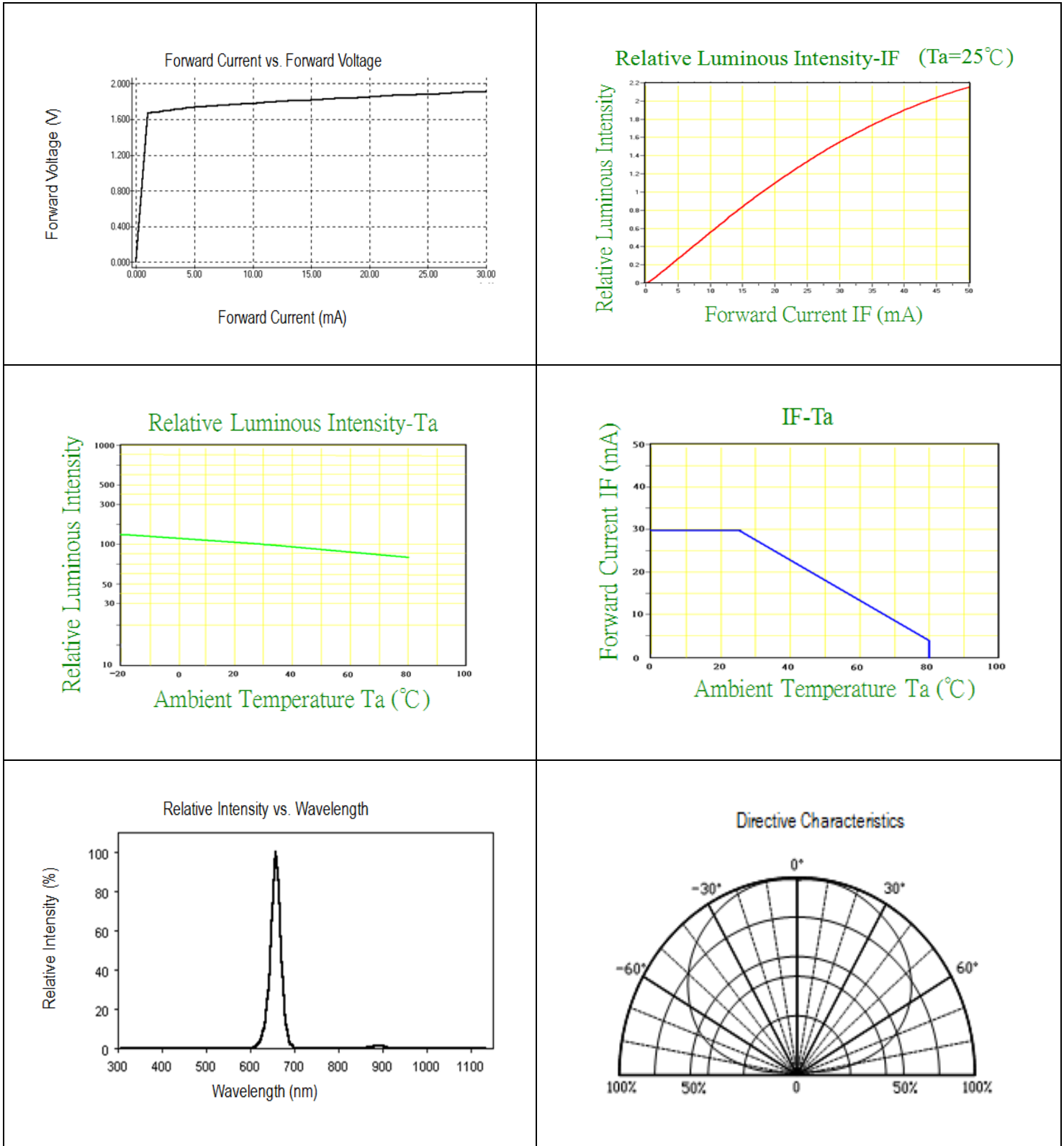

Solder Profile & Footprint

- Recommended tin solder specifications: melting temperature in the range of 178~192 °C
- The recommended reflow soldering profile is as follows (temperatures indicated are as measured on the surface of the LED resin):

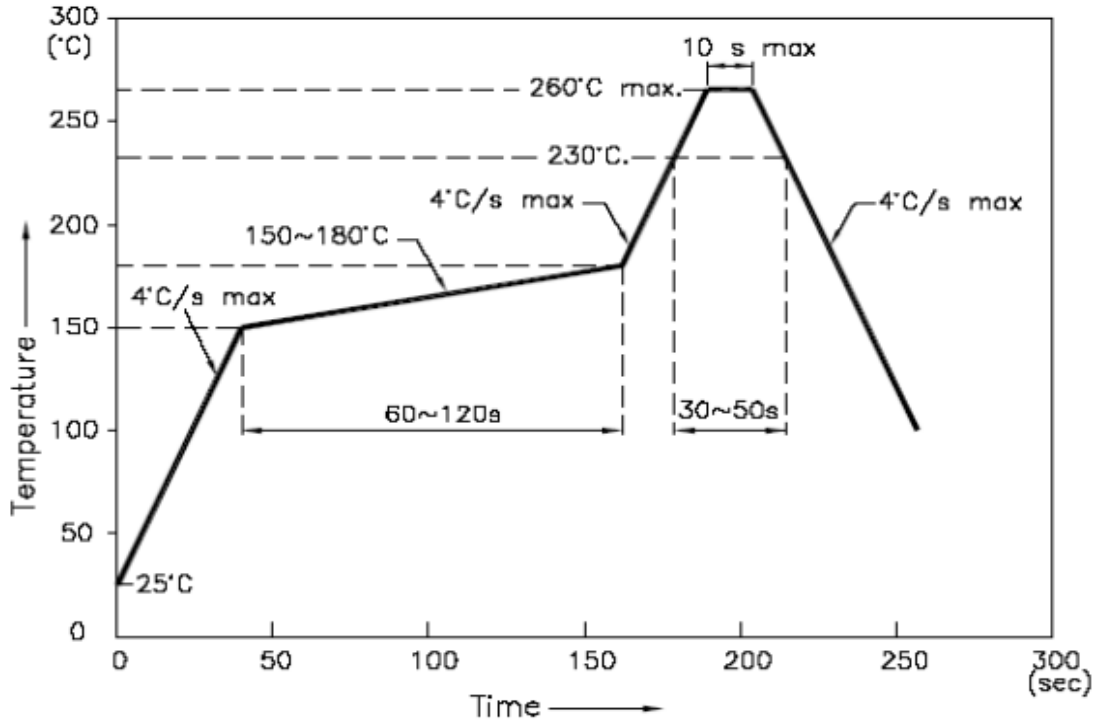

Recommended Pad Layout

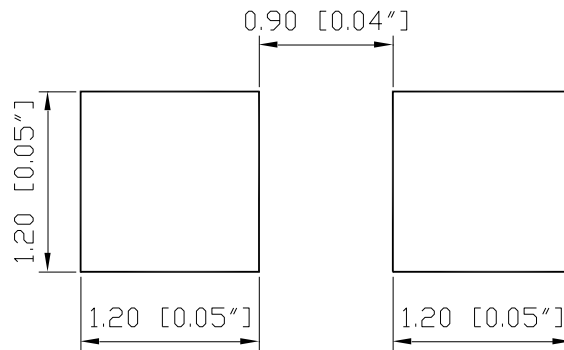

Units: mm

Tolerance: ± 0.1mm

Product: QBL617-S1	Date: September 18, 2014	Page 6 of 9
	Version# 1.0	

Packing

Reel Dimension:

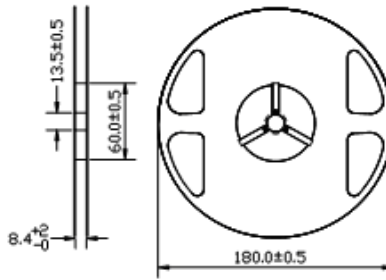

Unit: mm

Tape Dimension:

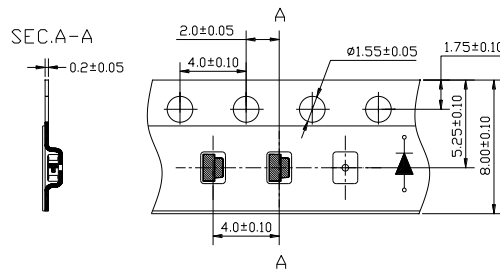

Unit: mm

Arrangement of Tape:

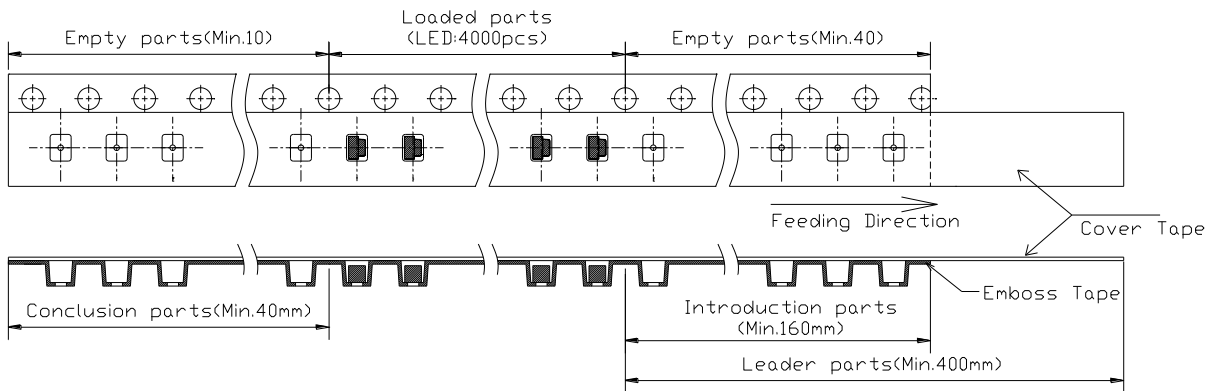

Packaging Specifications:

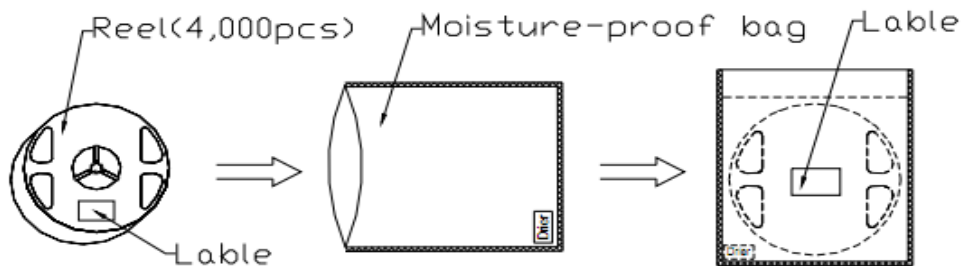

Labeling

Part No: _____
 Customer P/N: _____
 Item: _____
 Q'ty: _____
 Vf: _____
 Iv: _____
 WI: _____
 Date: _____

Made in China**Ordering Information**

Part #	Orderable Part #	Spec Range	Quantity per reel
QBLP617-S1	QBLP617-S1	Iv=12mcd typ. @ I _F =20mA, λ _D =635nm ~ 650nm	4,000 units

Product: QBL617-S1	Date: September 18, 2014	Page 8 of 9
	Version# 1.0	

Revision History

Description:	Revision #	Revision Date
New Release of QBLP617-S1	V1.0	09/18/2014

Disclaimer

QT-BRIGHTTEK reserves the right to make changes without further notice to any products herein to improve reliability, function or design. QT-BRIGHTTEK does not assume any liability arising out of the application or use of any product or circuit described herein; neither does it convey any license under its patent rights, nor the rights of others.

Life Support Policy

QT-BRIGHTTEK's products are not authorized for use as critical components in life support devices or systems without the express written approval of QT-BRIGHTTEK. As used herein:

1. Life support devices or systems are devices or systems which, (a) are intended for surgical implant into the body, or (b) support or sustain life, and (c) whose failure to perform when properly used in accordance with instructions for use provided in the labeling, can be reasonably expected to result in a significant injury of the user.
2. A critical component in any component of a life support device or system whose failure to perform can be reasonably expected to cause the failure of the life support device or system, or to affect its safety or effectiveness.