

NOTES: UNLESS OTHERWISE SPECIFIED

1.

NOTICE:	THIS IS A RoHS COMPLIANT COMPONENT/PRODUCT. ALL ENGINEERING CHANGES MUST HAVE PRIOR APPROVAL BY THE DESIGN CENTER.
RoHS 	
2. PLASTIC: THERMOSET PLASTIC MATERIAL WITH FLAMMABILITY RATING UL 94V-0 OR BETTER.
3. SOLDERABILITY: CONFORMS TO ANSI/J-STD-002, 245°C REFLOW PEAK TEMPERATURE PER IPC/EIA J-STD-003A
4. OPERATING TEMPERATURE: 0°C TO +70°C
5. STORAGE TEMPERATURE: -20°C TO +125°C
6. JEDEC MOISTURE: LEVEL 1.
7. DIMENSIONS ARE IN INCHES WITH THE FOLLOWING TOLERANCES:
.XX = ±.02
.XXX = ±.010
8. REVISION: MP1, MP2, ARE PRELIMINARY.

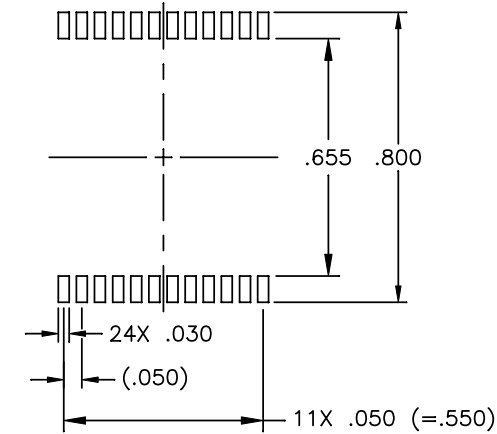
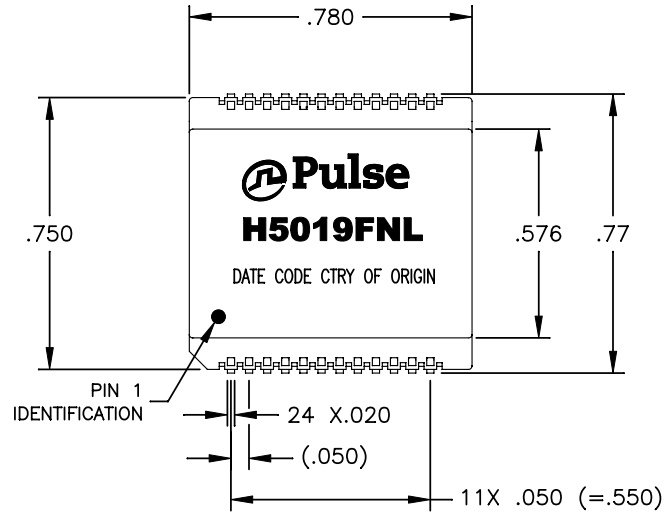

SUGGESTED LAND PATTERN

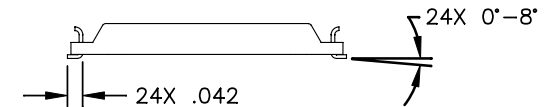
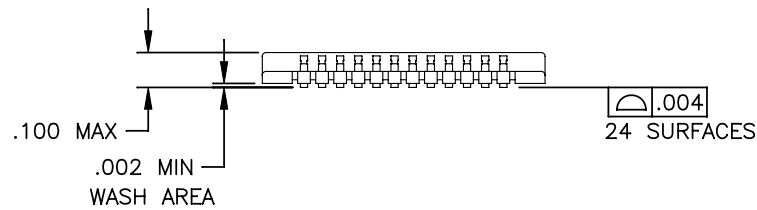

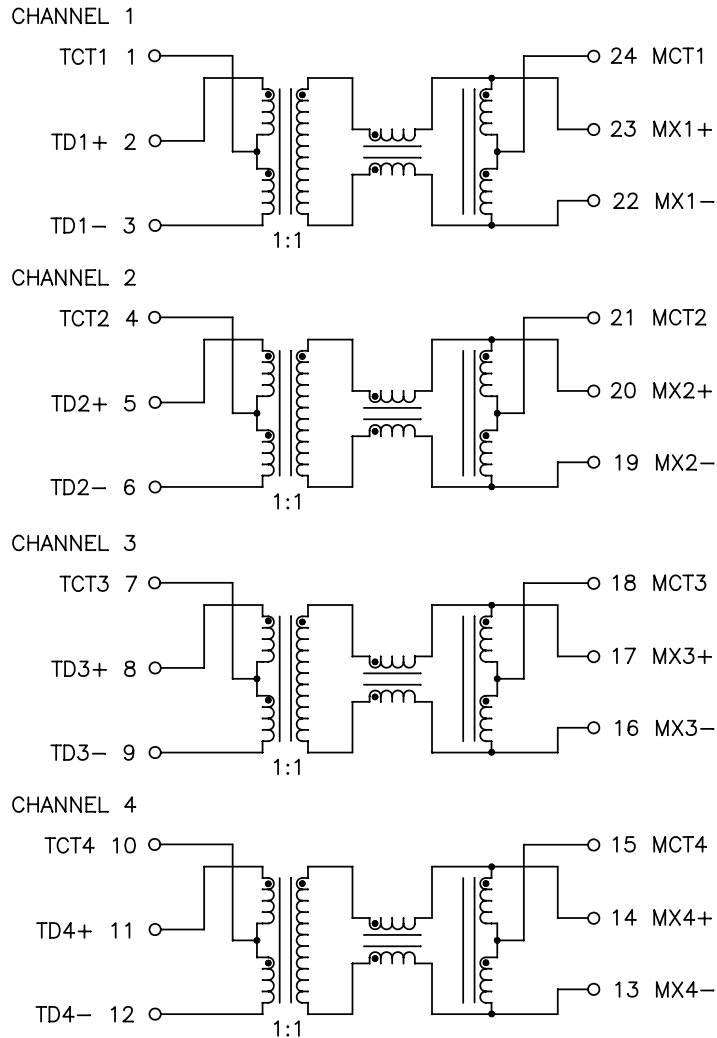

SCHEMATIC

ELECTRICAL CHARACTERISTICS AT +25°C

PARAMETER	SPECIFICATIONS		
OPERATING TEMP	0°C – 70 °C		
TURNS RATIO	1 : 1 ±2%		
POLARITY	PER SCHEMATIC		
OCL, TRANSMIT CHANNEL	350 uh MIN. WITH 8mA DC BIAS, -0 TO 70 °C		
INSERTION LOSS	100 KHz	1-100 MHz	125 MHz
	-1.2 dB MAX	-1.0 dB MAX	-3.0 dB MAX
RETURN LOSS (Z OUT = 100 OHM ±15%)	1-40 MHz		40-100 MHz
	-16 dB MIN	-18 dB MIN (ZOUT=100 OHMS)	-10+20*LOG ₁₀ (f/80) dB MIN
CROSSTALK (TX-RX)	1 MHz	30-100 MHz	
	-50 dB MIN	-55+24*LOG ₁₀ (f/10) dB MIN	
DIFFERENTIAL TO COMMON MODE REJECTION	2 MHz	30-100 MHz	
	-50 dB MIN	-43+22*LOG ₁₀ (f/30) dB MIN	
INPUT – OUTPUT ISOLATION	1500 VRMS @ 60 SECONDS		

NOTE: f IS FREQUENCY IN MHZ.

LEGEND

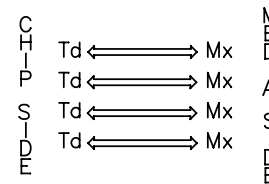

ALL CHANNELS ARE
IN PHASE BETWEEN
INPUT AND OUTPUT

PULSE CONFIDENTIAL & PROPRIETARY	PRODUCT DESCRIPTION	PS DRAWING	SHEET:	DWG. NO./ PART NO.	REV.
	MDL,SIN,1GD,1:1,SM,TU	PS-2761.001-A	2	H5019FNL	MP1