

BK PRECISION®

Model: 2190E

100 MHz Digital Storage Oscilloscope

USER MANUAL



Safety Summary

The following safety precautions apply to both operating and maintenance personnel and must be followed during all phases of operation, service, and repair of this instrument.



Before applying power to this instrument:

- Read and understand the safety and operational information in this manual.
- Apply all the listed safety precautions.
- Verify that the voltage selector at the line power cord input is set to the correct line voltage. Operating the instrument at an incorrect line voltage will void the warranty.
- Make all connections to the instrument before applying power.
- Do not operate the instrument in ways not specified by this manual or by B&K Precision.

Failure to comply with these precautions or with warnings elsewhere in this manual violates the safety standards of design, manufacture, and intended use of the instrument. B&K Precision assumes no liability for a customer's failure to comply with these requirements.

Category rating

The IEC 61010 standard defines safety category ratings that specify the amount of electrical energy available and the voltage impulses that may occur on electrical conductors associated with these category ratings. The category rating is a Roman numeral of I, II, III, or IV. This rating is also accompanied by a maximum voltage of the circuit to be tested, which defines the voltage impulses expected and required insulation clearances. These categories are:

Category I (CAT I): Measurement instruments whose measurement inputs are not intended to be connected to the mains supply. The voltages in the environment are typically derived from a limited-energy transformer or a

battery.

Category II (CAT II): Measurement instruments whose measurement inputs are meant to be connected to the mains supply at a standard wall outlet or similar sources. Example measurement environments are portable tools and household appliances.

Category III (CAT III): Measurement instruments whose measurement inputs are meant to be connected to the mains installation of a building. Examples are measurements inside a building's circuit breaker panel or the wiring of permanently-installed motors.

Category IV (CAT IV): Measurement instruments whose measurement inputs are meant to be connected to the primary power entering a building or other outdoor wiring.



Do not use this instrument in an electrical environment with a higher category rating than what is specified in this manual for this instrument.



You must ensure that each accessory you use with this instrument has a category rating equal to or higher than the instrument's category rating to maintain the instrument's category rating. Failure to do so will lower the category rating of the measuring system.

Electrical Power

This instrument is intended to be powered from a CATEGORY II mains power environment. The mains power should be 120 V RMS or 240 V RMS. Use only the power cord supplied with the instrument and ensure it is appropriate for your country of use.

Ground the Instrument

WARNING

To minimize shock hazard, the instrument chassis and cabinet must be connected to an electrical safety ground. This instrument is grounded through the ground conductor of the supplied, three-conductor AC line power cable. The power cable must be plugged into an approved three-conductor electrical outlet. The power jack and mating plug of the power cable meet IEC safety standards.

WARNING

Do not alter or defeat the ground connection. Without the safety ground connection, all accessible conductive parts (including control knobs) may provide an electric shock. Failure to use a properly-grounded approved outlet and the recommended three-conductor AC line power cable may result in injury or death.

WARNING

Unless otherwise stated, a ground connection on the instrument's front or rear panel is for a reference of potential only and is not to be used as a safety ground.

Do not operate in an explosive or flammable atmosphere

WARNING

Do not operate the instrument in the presence of flammable gases or vapors, fumes, or finely-divided particulates.

WARNING

The instrument is designed to be used in office-type indoor environments.

Do not operate the instrument

- In the presence of noxious, corrosive, or flammable fumes, gases, vapors, chemicals, or finely-divided particulates.
- In relative humidity conditions outside the instrument's specifications.
- In environments where there is a danger of any liquid being spilled on the instrument or where any liquid can condense on the instrument.
- In air temperatures exceeding the specified operating temperatures.
- In atmospheric pressures outside the specified altitude limits or where the surrounding gas is not air.
- In environments with restricted cooling air flow, even if the air temperatures are within specifications.
- In direct sunlight.

CAUTION

This instrument is intended to be used in an indoor pollution degree 2 environment. The operating temperature range is 0 °C to 40 °C and the operating humidity is ≤ 85 % relative humidity at 40 °C, with no condensation allowed. Measurements made by this instrument may be outside specifications if the instrument is used in non-office-type environments. Such environments may include rapid temperature or humidity changes, sunlight, vibration and/or mechanical shocks, acoustic noise, electrical noise, strong electric fields, or strong magnetic fields.

Do not operate instrument if damaged

WARNING

If the instrument is damaged, appears to be damaged, or if any liquid, chemical, or other material gets on or inside the instrument, remove the instrument's power cord, remove the instrument from service, label it as not to be operated, and return the instrument to B&K Precision for repair.

Notify B&K Precision of the nature of any contamination of the instrument.

Clean the instrument only as instructed



Do not clean the instrument, its switches, or its terminals with contact cleaners, abrasives, lubricants, solvents, acids/bases, or other such chemicals. Clean the instrument only with a clean dry lint-free cloth or as instructed in this manual.

Not for critical applications



This instrument is not authorized for use in contact with the human body or for use as a component in a life-support device or system.

Do not touch live circuits



Instrument covers must not be removed by operating personnel. Component replacement and internal adjustments must be made by qualified service-trained maintenance personnel who are aware of the hazards involved when the instrument's covers and shields are removed. Under certain conditions, even with the power cord removed, dangerous voltages may exist when the covers are removed. To avoid injuries, always disconnect the power cord from the instrument, disconnect all other connections (for example, test leads, computer interface cables, etc.), discharge all circuits, and verify there are no hazardous voltages present on any conductors by measurements with a properly-operating voltage-sensing device before touching any internal parts. Verify the voltage-sensing device is working properly before and after making the measurements by testing with known-operating voltage sources and test

for both DC and AC voltages. Do not attempt any service or adjustment unless another person capable of rendering first aid and resuscitation is present.

Do not insert any object into an instrument's ventilation openings or other openings.

WARNING

Hazardous voltages may be present in unexpected locations in circuitry being tested when a fault condition in the circuit exists.

Servicing

CAUTION

Do not substitute parts that are not approved by B&K Precision or modify this instrument. Return the instrument to B&K Precision for service and repair to ensure that safety and performance features are maintained.

Cooling fans

CAUTION

This instrument contains one or more cooling fans. For continued safe operation of the instrument, the air inlet and exhaust openings for these fans must not be blocked nor must accumulated dust or other debris be allowed to reduce air flow. Maintain at least 25 mm clearance around the sides of the instrument that contain air inlet and exhaust ports. If mounted in a rack, position power devices in the rack above the instrument to minimize instrument heating while rack mounted. Do not continue to operate the instrument if you cannot verify the fan is operating (note some fans may have intermittent duty cycles). Do not insert any object into the fan's inlet or outlet.

For continued safe use of the instrument

- Do not place heavy objects on the instrument.
- Do not obstruct cooling air flow to the instrument.
- Do not place a hot soldering iron on the instrument.
- Do not pull the instrument with the power cord, connected probe, or connected test lead.
- Do not move the instrument when a probe is connected to a circuit being tested.

Compliance Statements

Disposal of Old Electrical & Electronic Equipment (Applicable in the European Union and other European countries with separate collection systems)

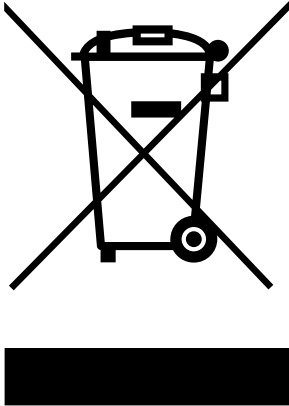

This product is subject to Directive 2002/96/EC of the European Parliament and the Council of the European Union on waste electrical and electronic equipment (WEEE), and in jurisdictions adopting that Directive, is marked as being put on the market after August 13, 2005, and should not be disposed of as unsorted municipal waste. Please utilize your local WEEE collection facilities in the disposition of this product and otherwise observe all applicable requirements.

CE Declaration of Conformity

This instrument meets the requirements of 2006/95/EC Low Voltage Directive and 2004/108/EC Electromagnetic Compatibility Directive with the following standards.

Low Voltage Directive

- EN61010-1: 2001
- EN61010-031: 2002+A1: 2008

EMC Directive

- EN 61326-1:2006
- EN 61000-3-2: 2006+A2: 2009
- EN 61000-3-3: 2008

Safety Symbols











	Refer to the user manual for warning information to avoid hazard or personal injury and prevent damage to instrument.
	Electric Shock hazard
	Alternating current (AC)
	Chassis (earth ground) symbol.
	Ground terminal
	On (Power). This is the In position of the power switch when instrument is ON.
	Off (Power). This is the Out position of the power switch when instrument is OFF.
	Off (Supply). This is the AC mains connect/disconnect switch on top of the instrument.
	CAUTION indicates a hazardous situation which, if not avoided, will result in minor or moderate injury
	WARNING indicates a hazardous situation which, if not avoided, could result in death or serious injury
	DANGER indicates a hazardous situation which, if not avoided, will result in death or serious injury.

Table of Contents

Safety Summary	i
Compliance Statements	viii
Safety Symbols	x
1 General Information	1
1.1 Product Overview	1
1.2 Package Contents	1
1.3 Front Panel	2
Front Panel Description	2
1.4 Back Panel	3
Back Panel Description	4
1.5 Display Information	4
User Interface Description	5
2 Getting Started	6
2.1 Input Power Requirements	6
Input Power	6
2.2 Preliminary Check	6
Verify AC Input Voltage	7
Connect Power	7
Self-Test	7
Self Cal	7
Check Model and Firmware Version	8
Function Check	8
Probe Safety	10
Probe Attenuation	11
Probe Compensation	11
3 Functions and Operating Descriptions	13
3.1 Menu and Control Button	14
3.2 Connectors	16
3.3 Auto Setup	17

3.4	Default Setup.....	19
3.5	Universal Knob.....	23
3.6	Vertical System.....	23
	Using Vertical Position Knob and Volts/div Knob.....	24
3.7	Channel Function Menu.....	25
	Setting up Channels.....	28
3.8	Math Functions.....	34
	FFT Spectrum Analyzer.....	36
3.9	Using REF.....	43
3.10	Horizontal System.....	45
	Horizontal Control Knob.....	45
	Window Zone.....	46
3.11	Trigger System.....	47
	Signal Source.....	48
	Trigger Type.....	49
	Coupling.....	67
	Position.....	67
	Slope and Level.....	68
	Trigger Holdoff.....	69
3.12	Signal Acquisition System.....	70
3.13	Display System.....	75
	X-Y Format.....	79
3.14	Measure System.....	80
	Scale Measurement.....	80
	Cursor Measurement.....	80
3.15	Storage System.....	94
	Recalling Files.....	96
	Creating Folders and Files.....	96
	Save/Recall Setup.....	97
	Save/Recall Waveform.....	102
3.16	Utility System.....	109
	System Status.....	113
	Language.....	114
	Self Calibration.....	115
	Self Test.....	116
	Update Firmware.....	119

Pass/Fail.....	120
Waveform Record	125
Recorder (Scan Mode Only)	129
Help Menu	134
Education Mode	134
4 Application Examples	135
4.1 Taking Simple Measurements	135
4.2 Taking Cursor Measurements.....	136
4.3 Capturing a Single-Shot Signal.....	138
4.4 Analyzing Signal Details	139
4.5 Triggering on a Video Signal	140
4.6 Application of X-Y Function	141
4.7 Analyzing a Differential Communication Signal.....	143
5 Remote Control	144
6 Message Prompts and Troubleshooting.....	146
6.1 Message Prompts	146
6.2 Troubleshooting	147
7 Specifications	149
8 Calibration.....	153
SERVICE INFORMATION	154
LIMITED ONE-YEAR WARRANTY	155

1 General Information

1.1 Product Overview

The B&K Precision 2190E digital storage oscilloscope (DSO) is a portable benchtop instrument used for making measurements of signals and waveforms. The oscilloscope's bandwidth is capable of capturing up to 100 MHz signals with a real time sampling rate of up to 1 GSa/s. With up to 40k points of deep memory, more details of a signal can be captured and displayed on a large color LCD display for analysis.

Features:

- 2 channels with bandwidth up to 100 MHz
- Single channel real-time sampling rate of up to 1 GSa/s
- Up to 40k points of memory depth
- 7" Color TFT LCD display
- Trigger types: Edge, Pulse, Video, Slope, and Alternative
- Digital filter and waveform recorder functions
- Automatic measurement of 32 parameters (Voltage and Time)
- Standard USB host, USBTMC device, and LAN ports

1.2 Package Contents

Please inspect the instrument mechanically and electrically upon receiving it. Unpack all items from the shipping carton, and check for any obvious signs of physical damage that may have occurred during transportation. Report any damage to the shipping agent immediately. Save the original packing carton for possible future reshipment. Every instrument is shipped with the following contents:

- **1 x Quick Start guide (printed)**
- **1 x AC power cord**
- **1 x USB type A to Type B cable**
- **2 x 1:1/10:1 Passive Oscilloscope Probes**

Verify that all items above are included in the shipping container. If anything is missing, please contact B&K Precision.

1.3 Front Panel

It is important for you to familiarize yourself with the DSO's front panel before operating the instrument. Below is a brief introduction of the front panel function operation.

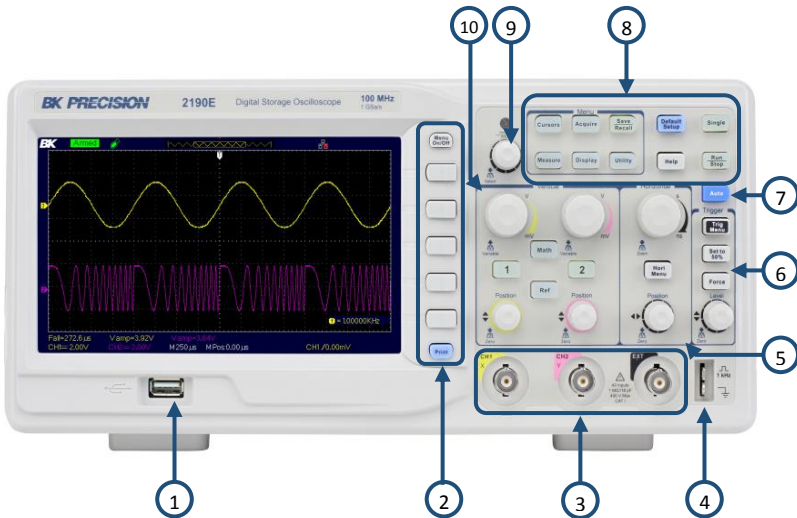

Figure 1.1 – Front Panel

Front Panel Description

-
- ① Front USB (Type A) Connector

 - ② Menu Function Keys, Menu On/Off, Print Key

 - ③ Input Channels (1 MΩ BNC)

 - ④ Probe Compensator (1 kHz and Ground)

⑤ **Horizontal Controls (Time Base)**

⑥ **Trigger Controls**

⑦ **Auto Setup Button**

⑧ **Menu and Measurement Buttons**

⑨ **Universal Knob**

⑩ **Vertical Controls**

1.4 Back Panel

The following images show back and side panel connection locations.

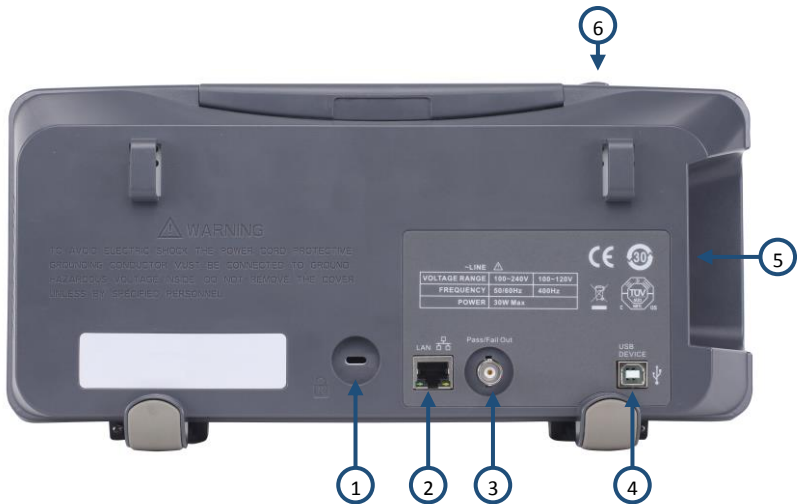

Figure 1.2 – Back Panel

Back Panel Description

- ① Security Lock Receptacle
- ② LAN Interface
- ③ Pass/Fail Output
- ④ Rear USB (Type B) Device Connector
- ⑤ Power Input Connector
- ⑥ AC Power Switch

1.5 Display Information

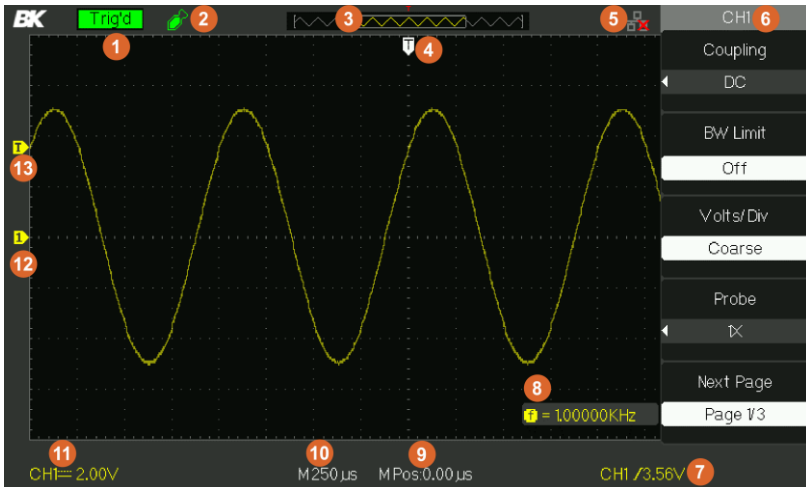

Figure 1.3 – Display Screen

User Interface Description

① **Trigger Status**

② **USB Host Port Connection Indicator**

③ **Waveform Display Preview**

④ **Horizontal Trigger Position Marker**

⑤ **LAN Port Connection Indicator**

⑥ **Menu**

⑦ **Trigger Source, Type, and Level Indicator**

⑧ **Frequency Counter**

⑨ **Horizontal Delay Position**

⑩ **Horizontal Time Base Setting**

⑪ **Channel Source, Coupling Type, Volts/Division, BW Limit Indicator**

⑫ **Vertical Display Markers (Ground Reference)**

⑬ **Trigger Level Display Marker**

2 Getting Started

Before connecting and powering up the instrument, please review and go through the instructions in this chapter.

2.1 Input Power Requirements

Input Power

The supply has a universal AC input that accepts line voltage and frequency input within:

100 – 240 V (+/- 10%), 50/60 Hz (+/- 5%)

100 – 127 V, 45 – 440 Hz

Before connecting to an AC outlet or external power source, be sure that the power switch is in the OFF position and verify that the AC power cord, including the extension line, is compatible with the rated voltage/current and that there is sufficient circuit capacity for the power supply. Once verified, connect the cable firmly.

WARNING

The included AC power cord is safety certified for this instrument operating in rated range. To change a cable or add an extension cable, be sure that it can meet the required power ratings for this instrument. Any misuse with wrong or unsafe cables will void the warranty.

2.2 Preliminary Check

Complete the following steps to verify that the oscilloscope is ready for use.

Verify AC Input Voltage

Verify and check to make sure proper AC voltages are available to power the instrument. The AC voltage range must meet the acceptable specification as explained in section 2.1.

Connect Power

Connect AC power cord to the AC receptacle in the rear panel and press the power switch to the ON position to turn ON the instrument. The instrument will have a boot screen while loading, after which the main screen will be displayed.

Self-Test

The instrument has 3 self-test options to test the screen, keys, and the LED back lights of the function, menu, and channel keys as shown below.

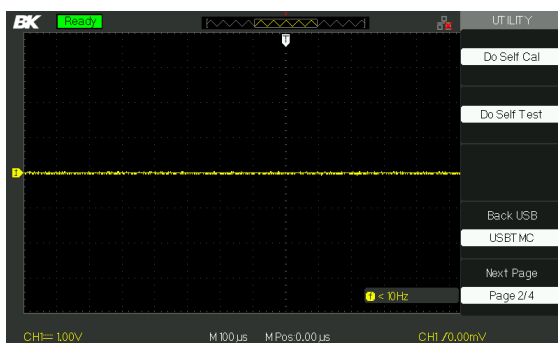

Figure 2.1 – Self Test Menu

To perform the self-test, please refer to the **Self Test** section for further instructions.

Self-Cal

This option runs an internal self-calibration procedure that will check and adjust the instrument. To perform the self-calibration, please refer to the **Self Calibration** section for further instructions.

Check Model and Firmware Version

The model and firmware version can be verified from within the menu system.

Press **Utility** and select **System Status** option. The software/firmware version, hardware version, model, and serial number will be displayed. Press the **Single** key to exit.

Function Check

Follow the steps below to do a quick check of the oscilloscope's functionality.

1. Power on the oscilloscope. Press "DEFAULT SETUP" to show the result of the self-check. The probe default attenuation is 1X.

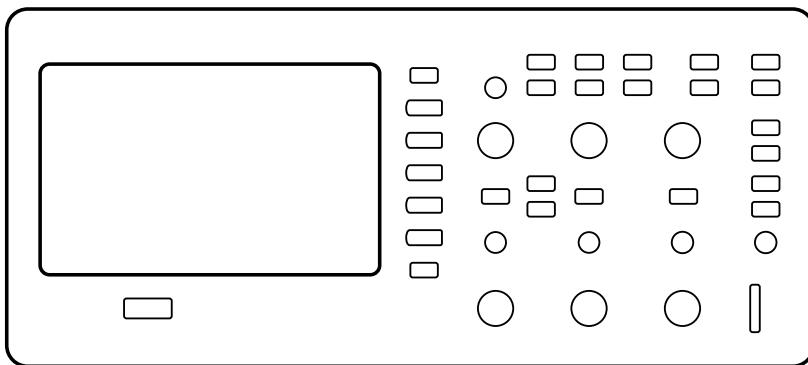

Figure 2.2 – Scope Layout

2. Set the switch to 1X on the probe and connect the probe to channel 1 on the oscilloscope. To do this, align the slot in the probe connector with the key on the CH 1 BNC, push to connect, and twist to the right to lock the probe in place. Connect the probe tip and reference lead to the PROBE COMP connectors.

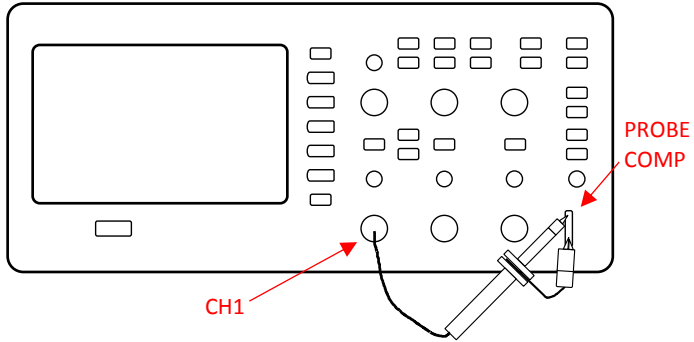

Figure 2.3 – Probe Compensation

3. Press "AUTO" to show the 1 kHz frequency and about 3V peak-peak square wave in couple seconds.

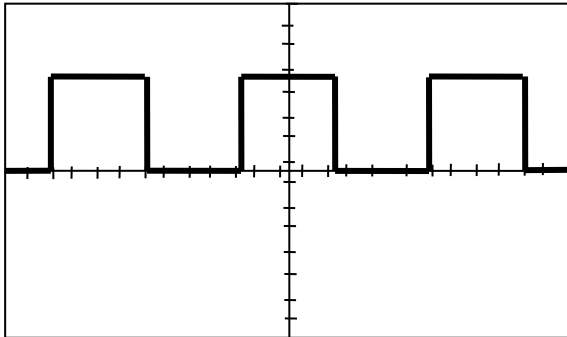

Figure 2.4 – 3 Vpp Square Wave

4. Press "CH1" two times to turn off channel 1, Press "CH2" to change screen into channel 2, reset the channel 2 as step 2 and step 3.

Probe Safety

A guard around the probe body provides a finger barrier for protection from electric shock.

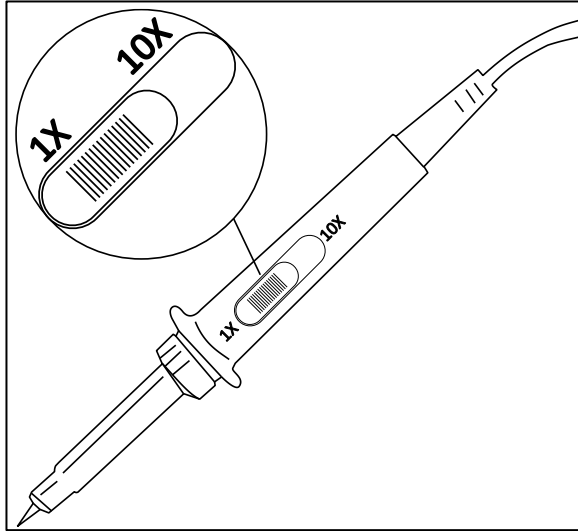

Figure 2.5 – Oscilloscope Probe

Connect the probe to the oscilloscope and connect the ground terminal to ground before you take any measurements.

SHOCK HAZARD

To avoid electric shock when using the probe, keep fingers behind the guard on the probe body.



To avoid electric shock while using the probe, do not touch metallic portions of the probe head while it is connected to a voltage source. Connect the probe to the oscilloscope and connect the ground terminal to ground before you take any measurements.

Probe Attenuation

Probes are available with various attenuation factors which affect the vertical scale of the signal. The Probe Check function verifies that the Probe attenuation option matches the attenuation of the probe.

You can push a vertical menu button (such as the CH 1 MENU button), and select the Probe option that matches the attenuation factor of your probe.

NOTE: The default setting for the Probe option is 1X.

Be sure that the attenuation switch on the probe matches the Probe option in the oscilloscope. Switch settings are 1X and 10X.

NOTE: When the attenuation switch is set to 1X, the probe limits the bandwidth of the oscilloscope to 6 MHz (according to Probe spec). To use the full bandwidth of the oscilloscope, be sure to set the switch to 10X

Probe Compensation

As an alternative method to Probe Check, you can manually perform this adjustment to match your probe to the input channel.

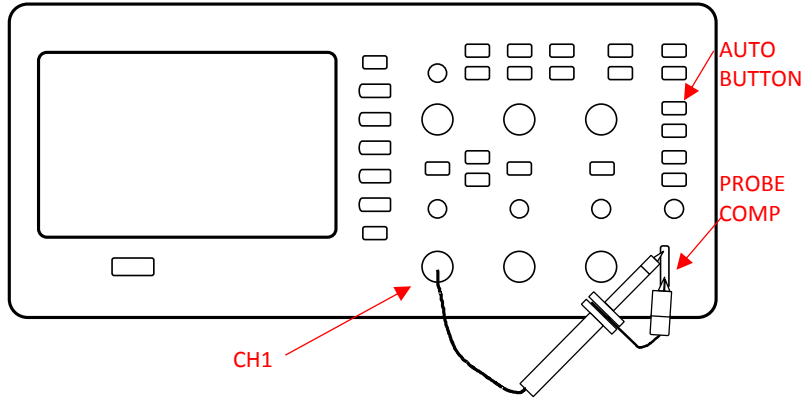

Figure 2.6 – Probe Compensation Setup

1. Set the Probe option attenuation in the channel menu to 10X. Do so by pressing CH1 button and selecting “Probe” from menu. Select 10X. Set the switch to 10X on the probe and connect the probe to channel 1 on the oscilloscope. If you use the probe hook-tip, ensure a proper connection by firmly inserting the tip onto the probe.
2. Attach the probe tip to the PROBE COMP 3V connector and the reference lead to the PROBE COMP Ground connector. Display the channel and then push the “AUTO” button.
3. Check the shape of the displayed waveform.

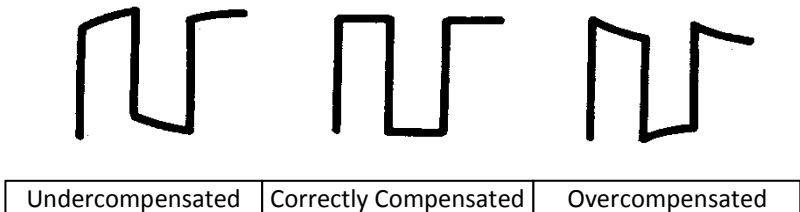

Figure 2.7 – Compensation Illustration

4. If necessary, adjust your probe’s compensation trimmer pot. Repeat as necessary.

3 Functions and Operating Descriptions

To use your oscilloscope effectively, you need to learn about the following oscilloscope functions:

- Menu and control button
- Connector
- Auto Setup
- Default Setup
- Universal knob
- Vertical System
- Channel Function Menu
- Math Functions
- Using REF
- Horizontal System
- Trigger System
- Acquiring signals System
- Display System
- Measuring waveforms System
- Utility System
- Storage System
- Online Help function

3.1 Menu and Control Button



Figure 3.1 – Control Buttons

- **Channel buttons (CH1, CH2):** Press a channel button to turn that channel ON or OFF and open the channel menu for that channel. You can use the channel menu to set up a channel. When the channel is on, the channel button is lit.
- **MATH:** Press to display the Math menu. You can use the MATH menu to use the oscilloscope's Math functions.
- **REF:** Press to display the Ref Wave menu. You can use this menu to save and recall four or two reference waveforms to and from internal memory.

- **HORI MENU:** Press to display the Horizontal menu. You can use the Horizontal menu to display the waveform and zoom in a segment of a waveform.
- **TRIG MENU:** Press to display the Trigger menu. You can use the Trigger menu to set the trigger type (Edge, Pulse, Video, Slope, Alternative) and trigger settings.
- **SET TO 50%:** Press to stabilize a waveform quickly. The oscilloscope can set the trigger level to be halfway between the minimum and maximum voltage level automatically. This is useful when you connect a signal to the EXT TRIG connector and set the trigger source to Ext or Ext/5.
- **FORCE:** Use the FORCE button to complete the current waveform acquisition whether the oscilloscope detects a trigger or not. This is useful for Single acquisitions and Normal trigger mode.
- **SAVE/RECALL:** Press to display the Save/Recall menu. You can use the Save/Recall menu to save and recall up to 20 oscilloscope setups and 10 waveforms to/from internal memory or a USB memory device (limited by memory capacity of the USB flash drive). You can also use it to recall the default factory settings, to save waveform data as a comma-delimited file (.CSV), and to save the displayed waveform image.
- **ACQUIRE:** Press to display Acquire menu. You can use the Acquire menu to set the acquisition Sampling Mode (Sampling, Peak Detect, and Average).
- **MEASURE:** Press to display a menu of measurement parameters.
- **CURSORS:** Display the Cursor Menu. Vertical Position controls adjust cursor position while displaying the Cursor Menu and the cursors are activated. Cursors remain displayed (unless the “Type” option is set to “Off”) after leaving the Cursor Menu but are not adjustable.
- **DISPLAY:** Press to open the Display menu. You can use the Display menu to set grid and waveform display styles, and persistence.
- **UTILITY:** Press to open the Utility menu. You can use the Utility menu to configure oscilloscope features, such as

sound, language, counter, etc. You can also view system status and update software.

- **DEFAULT SETUP:** Press to reset the oscilloscope's settings to the default factory configuration.
- **HELP:** Enter the online help system.
- **AUTO:** Automatically sets the oscilloscope controls to produce a usable display of the input signals.
- **RUN/STOP:** Continuously acquires waveforms or stops the acquisition.
Note: If waveform acquisition is stopped (using the RUN/STOP or SINGLE button), the TIME/DIV control expands or compresses the waveform.
- **SINGLE:** Acquire a single waveform and then stops waveform acquisition.

3.2 Connectors



Figure 3.2 – Connectors

- **Channel Connector (CH1, CH2):** Input connectors for waveform display.
- **EXT TRIG:** Input connector for an external trigger source. Use the Trigger Menu to select the “Ext” or “Ext/5” trigger source.
- **Probe Compensation:** 1 kHz voltage probe compensation output and ground. Use to electrically match the probe to the oscilloscope input circuit.

3.3 Auto Setup

The 2190E Digital Storage Oscilloscope has an Auto Setup function that identifies the waveform types and automatically adjusts controls to produce a usable display of the input signal.

Press the AUTO front panel button, and then press the menu option button adjacent to the desired waveform as follows:

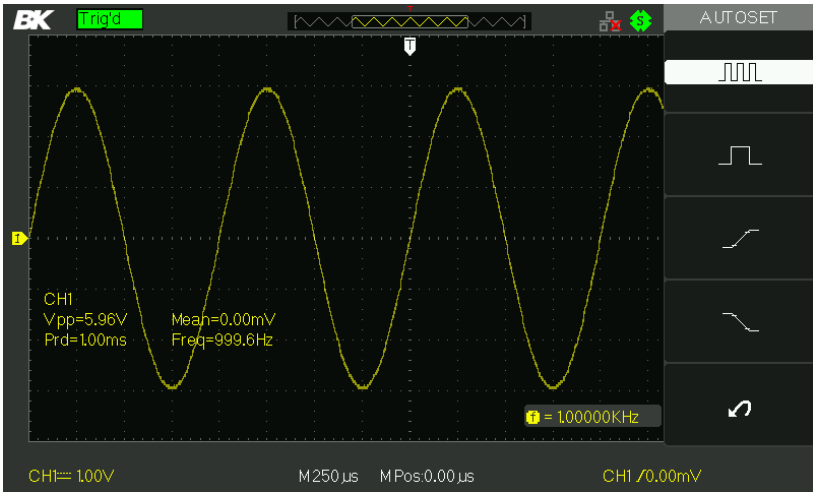







Figure 3.3 – Auto Setup

Table 3.1 – Autoset Menu

Option	Description
 (Multi-cycle sine)	Auto set the screen and display several cycles signal.
 (Single-cycle sine)	Set the screen and auto display single cycle signal.

 (Rising edge)	Auto set and show the rising time.
 (Falling edge)	Auto set and show the falling time.
 (Undo Setup)	Causes the oscilloscope to recall the previous setup.

Auto Set determines the trigger source based on the following conditions:

- If multiple channels have signals, channel with the lowest frequency signal.
- No signals found, the lowest-numbered channel displayed when Auto set was invoked.
- No signals found and no channels displayed, oscilloscope displays and uses channel 1.

Table 3.2 – Auto Set Function Menu Items

Function	Setting
Acquire Mode	Adjusted to Sampling
Display Format	Y-T
Display Type	Set to Dots for a video signal, set to Vectors for an FFT spectrum; otherwise, unchanged
Vertical Coupling	Adjusted to DC or AC according to the input signal
Bandwidth Limit	Off(full)

V/div	Adjusted
VOLTS/DIV adjustability	Coarse
Signal inverted	Off
Horizontal position	Center
Time/div	Adjusted
Trigger type	Edge
Trigger source	Auto detect the channel which has the input signal
Trigger slope	Rising
Trigger mode	Auto
Trigger coupling	DC
Trigger holdoff	Minimum
Trigger level	Set to 50%

NOTE: The AUTO button can be disabled. Please see “Education Mode” for details.

3.4 Default Setup

The oscilloscope is set up for normal operation when it is shipped from the factory. This is the default setup. To recall this setup, press the **DEFAULT SETUP** button. For the default options, buttons and controls when you press the **DEFAULT SETUP** button, refer to “Table 3.3 – Default Setup Table” below.

The **DEFAULT SETUP** button does not reset the following settings:

- Language option
- Saved reference waveform files
- Saved setup files
- Display contrast
- Calibration data

Table 3.3 – Default Setup Table

Menu or system	Options, knobs or buttons	Default setup
CH1,CH2	Coupling	DC
	BW limit	Off
	Volts/div	Coarse
	Probe	1X
	Invert	Off
	Filter	Off
	Volts/div	1.00V
MATH	Operation	CH1+CH2
	CH1 Invert	Off
	CH2 Invert	Off
	FFT operation:	
	Source	CH1
	Window	Hanning
	FFT Zoom	1X
	Scale	dBVrms
	Display	Split
HORIZONTAL	Window	Main
	Position	0.00 μ s
	Sec/div	500 μ s
	Window Zone	50.0 μ s
	Trigger knob	level
CURSOR	Type	Off

	Source	CH1
	Horizontal (voltage)	+/-3.2divs
	Vertical (time)	+/-5divs
ACQUIRE	three mode options	Sampling
	Averages	16
	Sampling mode	Real Time
DISPLAY	Type	Vectors
	Persist	off
	Gird	
	Intensity	60%
	Brightness	40%
	Format	YT
	Menu Display	infinite
SAVE/RECALL	Type	Setups
	Save To	Device
	Setup	No.1
REF	REFA/REFB	REFA
	Source	CH1
	REFA	off
	REFB	off
UTILITY	Sound	on
	Counter	On
	Back USB	USBTMC
	Pass/Fail	off
	Record	off
TRIGGER (edge)	Type	edge
	Source	CH1
	Slope	Rising
	Mode	Auto

	Coupling	DC
	LEVEL	0.00V
TRIGGER (pulse)	Type	pulse
	Source	CH1
	When	=
	Set Pulse Width	1.00ms
	Mode	Auto
	Coupling	DC
TRIGGER (Video)	Type	Video
	Source	CH1
	Polarity	Normal
	Sync	All Lines
	Standard	NTSC
	Mode	Auto
TRIGGER (Slope)	Type	Slope
	Source	CH1
	Time	1.00ms
	Mode	Auto
TRIGGER (Alternative)	Type	Alternative
	Source	CH1
	Mode	Edge
	Coupling	DC

3.5 Universal Knob



Figure 3.4 – Universal Knob

You can use the Universal knob with many functions, such as adjusting the hold off time, moving cursors, setting the pulse width, setting the video line, adjusting the upper and lower frequency limit, adjusting the X and Y masks when using the pass/fail function, etc. You can also turn the “Universal” knob to adjust the storage position of setups, waveforms, pictures when saving/recalling, and to select menu options. With some functions, the light indicator above the knob will turn on to indicate that the knob can be used to make changes or adjustments for that function. The knob can also be pushed to make a selection after changes/adjustments have been made.

3.6 Vertical System

The vertical control could be used for displaying waveform, rectify scale and position.



Figure 3.5 – Vertical System Controls

Using Vertical Position Knob and Volts/div Knob

- **Vertical “POSITION” Knob**
 1. Use the Vertical “POSITION” knobs to move the channel waveforms up or down on the screen. This button’s resolution varies as per the vertical scale.
 2. When you adjust the vertical position of channels waveforms, the vertical position information will display on the bottom left of the screen. For example “Volts Pos=24.6mV”.
 3. Press the vertical “POSITION” knob to set the vertical position to zero.
- **“Volts/div” Knob**
 1. Use the “Volts/div” knobs to control how the oscilloscope amplifies or attenuates the source signal of channel waveforms. When you turn the “volts/div” knob, the oscilloscope increases or decreases the vertical size of the waveform on the screen with respect to the ground level.
 2. When you press the “Volt/div” knob, you can switch “Volts/div” option between “Coarse” and “Fine”. The

vertical scale is set by a 1-2-5 step sequence in Coarse mode. Increase in the clockwise direction and decrease in the counterclockwise direction. In Fine mode, the knob changes the Volts/Div scale in small steps between the coarse settings. Again, increase in the clockwise direction and decrease in the counterclockwise direction.

3.7 Channel Function Menu

Table 3.4 – Channel Function Menu

Option	Setting	Introduction
Coupling	DC	DC passes both AC and DC components of the input signal.
	AC	AC blocks the DC component of the input signal and attenuates signals below 10 Hz.
	GND	GND disconnects the input signal.
BW limit	On	Limits the bandwidth to reduce display noise; filters the signal to reduce noise and other unwanted high frequency components.
	Off	
Volts/Div	Coarse	Selects the resolution of the Volts/Div knob
	Fine	Coarse defines a 1-2-5 sequence. Fine changes the resolution to small steps between the coarse settings.

Probe	1X, 5X 10X, 50X 100X, 500X, 1000X	Set to match the type of probe you are using to ensure correct vertical readouts.
Next Page	Page 1/3	Press this button to enter the second page menu





Table 3.5 – Channel Function Menu 2

Option	Setting	Instruction
Invert	on	Turn on invert function.
	off	Turn off invert function.
Filter		Press this button to enter the “Digital Filter menu”.
Next Page	Page 2/3	Press this button to enter the third page menu.

Table 3.6 – Channel Function Menu 3

Option	Setting	Introduction
Unit	V	Set the scale unit to voltage
	A	Set the scale unit to current.
Skew	-100 ns – 100ns	Set the skew time between two channels.
Next Page	Page 3/3	Press this button to return to the first page menu.

Table 3.7 – Digital Filter Menu

Option	Setting	Introduction
Digital Filter	On Off	Turn on the digital filter. Turn off the digital filter.
Type	   	Setup as LPF (Low Pass Filter). Setup as HPF (High Pass Filter). Setup as BPF (Band Pass Filter). Setup as BRF (Band Reject Filter).
Upper limit		Turn the “Universal” knob to set upper limit.
Lower limit		Turn the “Universal” knob to set lower limit.
Return		Return to the second page menu.

- **“GND” Coupling:** Use GND coupling to display a zero-volt waveform. Internally, the channel input is connected to a zero-volt reference level.
- **Fine Resolution:** The vertical scale readout displays the actual Volts/Div setting while in the fine resolution setting. Changing the setting to coarse does not change the vertical scale until the VOLTS/DIV control is adjusted.

NOTE:

The oscilloscope’s vertical response rolls off slowly above its specified bandwidth. Therefore, the FFT spectrum can show valid frequency information higher than the oscilloscope’s bandwidth. However, the magnitude information near or above the bandwidth will not be accurate.

If the channel is set to DC coupling, you can quickly measure the DC component of the signal by simply noting its distance from the ground symbol.

If the channel is set to AC coupling, the DC component of the signal is blocked allowing you to use greater sensitivity to display the AC component of the signal.

Setting up Channels

Each channel has its own separate Menu. The items are set up separately according to each channel.

1. Setup Channel Coupling

Take CH1 for example; the tested signal is a sine wave signal with DC deflection:

- Press “CH1” → “Coupling” → “AC”, Set to AC couple mode. This will block the DC component of the input signal.
- Press “CH1” → “Coupling” → “DC”, Set to DC couple mode. Both DC and AC components of the input signal will be captured.

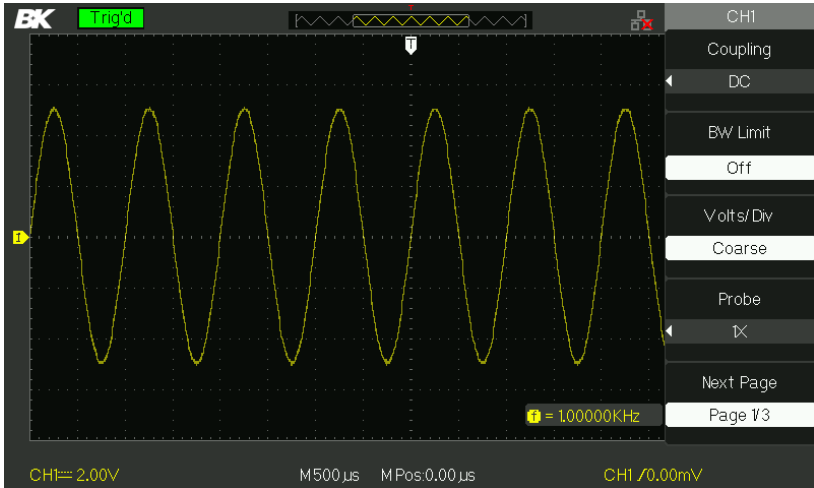

Figure 3.6 – DC Coupling

- Press “CH1”→“Coupling”→“GND”, Set to GROUND mode. This disconnects the input signal.

2. Bandwidth Limiting

Take CH1 for example:

- Press “CH1”→“BW Limit”→ “On”, and bandwidth will be limited to 20 MHz.
- Press “CH1”→“BW Limit”→ “Off”, and bandwidth limit will be disabled.

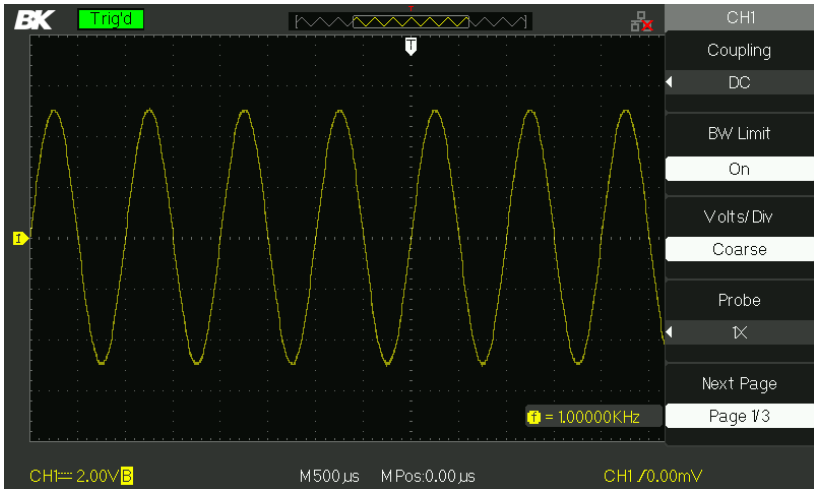

Figure 3.7 – Bandwidth Limit

3. Volts/Div Settings

Vertical scale adjust have Coarse and Fine modes, Vertical sensitivity range of 2 mV/div – 10 V/div.

Take CH1 for example:

- Press “CH1” → “Volts/Div” → “Coarse”. It is the default setting of Volts/Div, and makes the vertical scaling in a 1-2-5-step sequence from 2 mV/div, 5 mV/div, and 10 mV/div to 10 V/div.
- Press “CH1” → Volts/Div → Fine”. This setting changes the vertical control to small steps between the coarse settings. It will be helpful when you need to adjust the waveform vertical size in smaller steps.

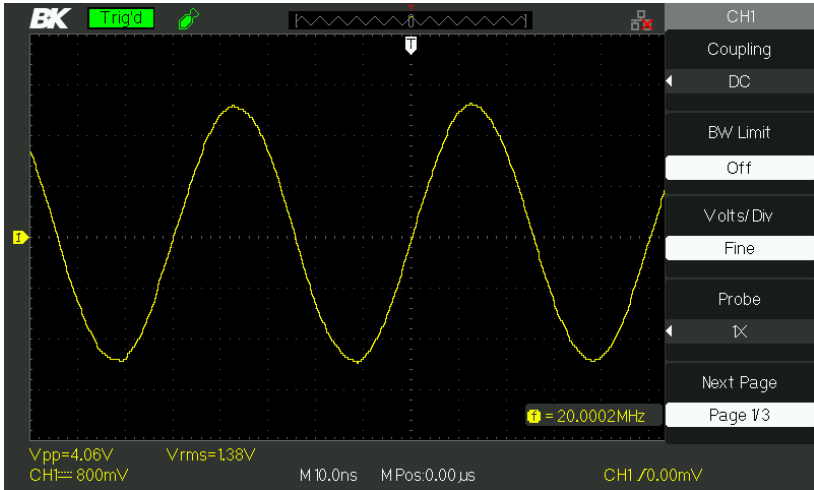

Figure 3.8 – Coarse/Fine Control

4. Setting Probe Attenuation

In order to set the attenuation coefficient, you need to specify it in the channel operation Menu. If the attenuation coefficient is 10:1, the input coefficient should be set to 10X, so that the Volts/div information and measurement testing is correct. Take CH1 for example, when you use the 100:1 probe:

- Press “CH1” → “Probe” → “100X”

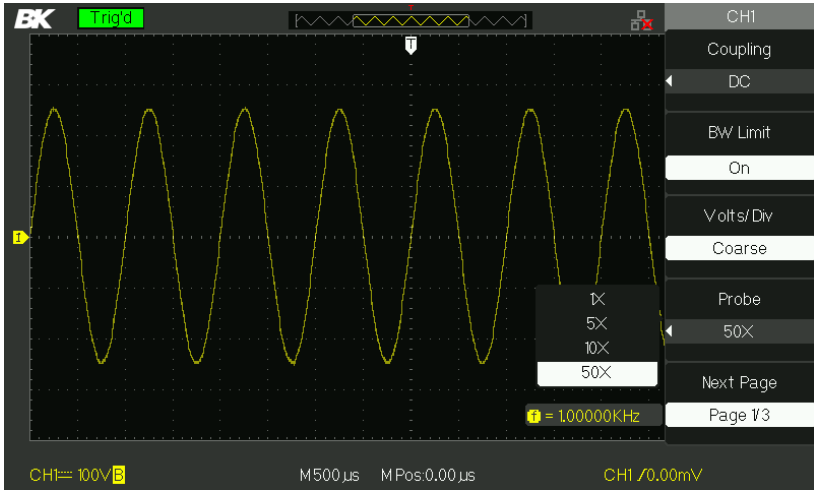

Figure 3.9 – Probe Attenuation Setting

5. Inverting Waveforms

Take CH1 for example:

- Press “CH1” → Next Page “Page 1/3” → “Invert” → “On”:

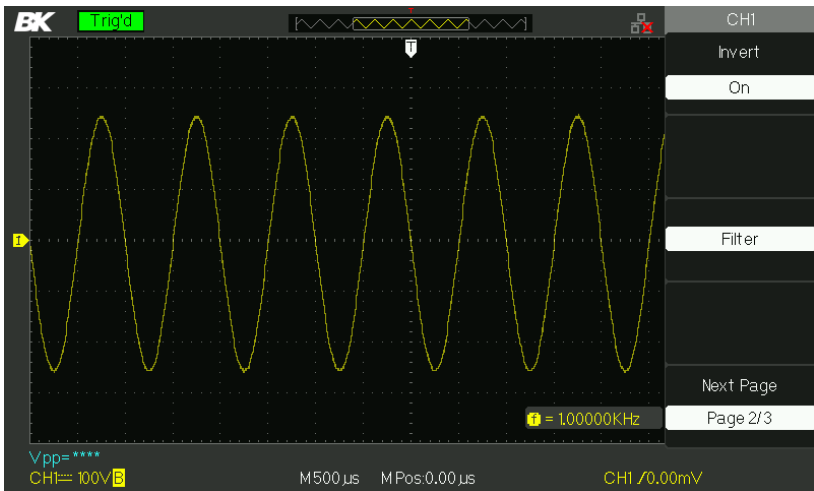

Figure 3.10 – Invert Waveform Screen

6. Using the Digital Filter

- Press “CH1” → Next Page “Page 1/3” → “Filter”, display the digital filter menu. Select “Filter Type”, then select “Upper Limit” or “Lower Limit” and turn the “Universal” knob to adjust them.
- Press “CH1” → Next Page “Page 1/3” → “Filter” → “Off”. Turn off the Digital Filter function.

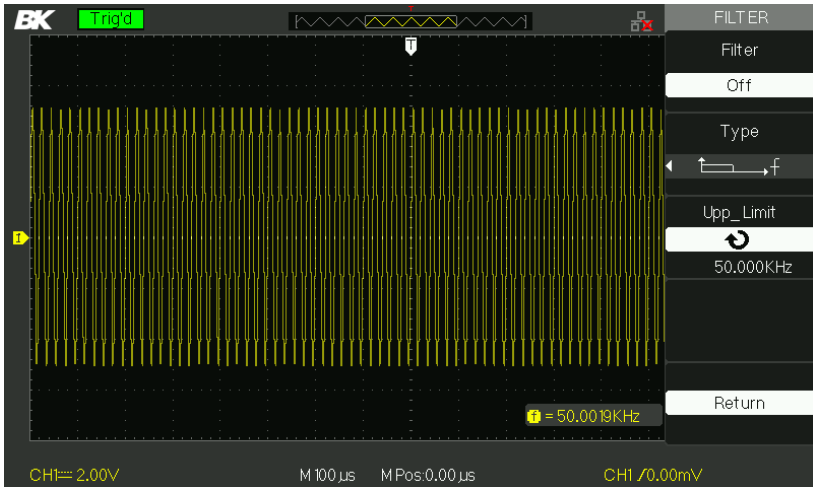

Figure 3.11 – Digital Filter Menu

- Press “CH1” → “Next Page “Page 1/3” → “Filter” → “On”. Turn on the Digital Filter function.

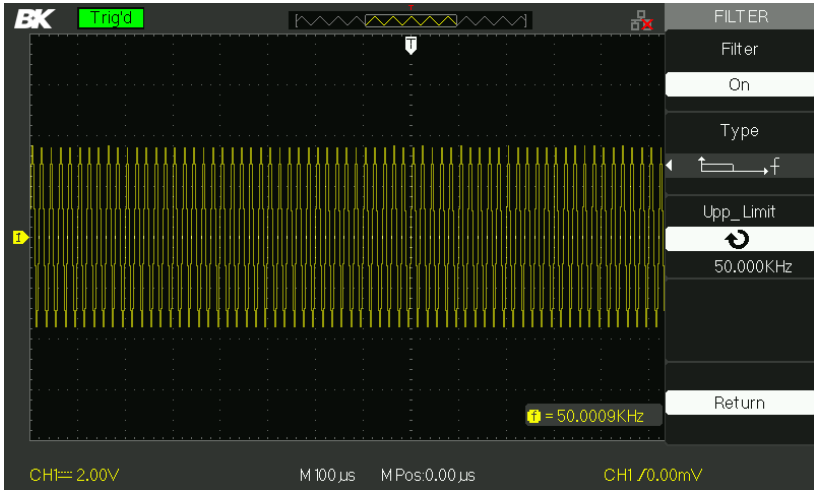

Figure 3.12 – Digital Filter Adjustment Screen

3.8 Math Functions

Math shows the results after $+$, $-$, $*$, $/$ and FFT operations of the CH1 and CH2. Press the MATH button to display the waveform math operations. Press the MATH button again to remove the math waveform display.

Table 3.8 – Math Function Menu

Function	Setting	Description
Operation	$+$, $-$, $*$, $/$, FFT	Math operates between signal source CH1 and CH2.
Source A	CH1 – CH2	Select CH1 or CH2 as Source A.
Source B	CH1 – CH2	Select CH1 or CH2 as Source B.
Invert	on	Invert the MATH waveform.

	off	Turn off MATH Invert function.
Next Page	Page 1/2	Enter the second page of MATH menu.

Table 3.9 – Math Function Menu 2



Function	Setting	Description
		Use universal knob to adjust the vertical position of the MATH waveform.
		Use universal knob to adjust the vertical scale of the MATH waveform.
Next Page	Page 2/2	Go back to first page of MATH menu.

Table 3.10 – Math Function Description

Operation	Setting	Description
+	A+B	Source A waveform adds Source B waveform.
-	A-B	Source B waveform is subtracted from Source A waveform.
*	A*B	Source A multiplied by Source B
/	A/B	Source A divided by Source B
FFT	Fast Fourier Transform.	

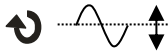
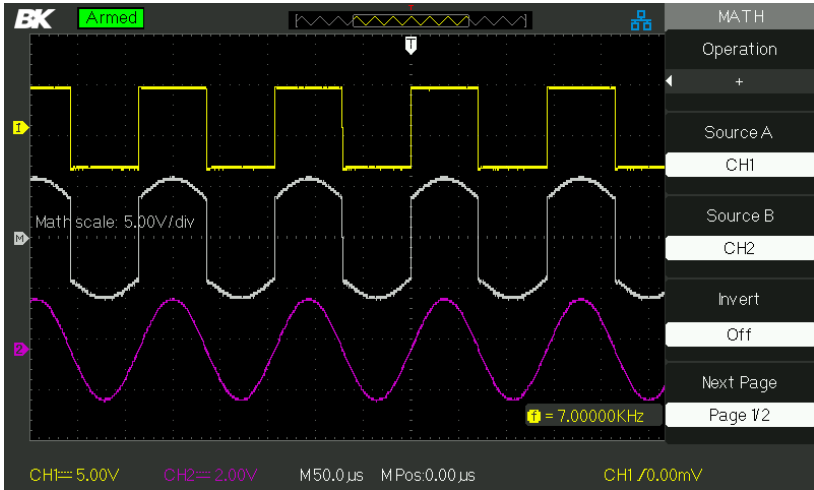

Figure 3.13 – Math Waveform

FFT Spectrum Analyzer

The FFT process mathematically converts a time-domain signal into its frequency components. You can use the Math FFT mode to view the following types of signals:

- Analyze the harmonic wave in the Power cable.
- Test the harmonic content and distortion in the system
- Show the Noise in the DC Power supply
- Test the filter and pulse response in the system
- Analyze vibration

Table 3.11 – FFT Function Menu 1

FFT Option	Setting	Description
Source	CH1, CH2	Select this channel as the FFT source.

Window	Hanning Hamming Rectangular Blackman	Select FFT window types.
FFT ZOOM	1X 2X 5X 10X	Changes the horizontal magnification of the FFT display.
Next Page	Page 1/2	Enter the second page of FFT menu.

Table 3.12 – FFT Function Menu 2

FFT Option	Setting	Description
Scale	Vrms	Set Vrms to be the Vertical Scale unit.
	dBVrms	Set dBVrms to be the vertical Scale unit.
Display	Split	Display FFT waveform on half screen.
	Full screen	Display FFT waveform on full screen.
Next Page	Page 2/2	Return to the first page of FFT menu.

To use the Math FFT mode, you need to perform the following steps:

1. Set up the source (time-domain) waveform.
2. Press the AUTO button to display an YT waveform.
3. Turn the vertical "POSITION" knob to move the YT waveform to the center vertically (zero divisions).
4. Turn the horizontal "POSITION" knob to position the part of the YT waveform that you want to analyze in the center eight divisions of the screen. The oscilloscope calculates the FFT spectrum using the center 1024 points of the time-domain waveform.
5. Turn the "Volts/div" knob to ensure that the entire waveform remains on the screen.
6. Turn the "S/div" knob to provide the resolution you want in the FFT spectrum.
7. If possible, set the oscilloscope to display many signal cycles.

To display FFT correctly, follow these steps:

1. Push the "MATH" button.
2. Set the "Operation" option to FFT.
3. Press the "Source" button to select "CH1" or "CH2" according to input signal channel.
4. Turn the "Time/div" knob to adjust the sampling rate (this parameter is displayed behind the time base parameter), making sure it is at least double the input signal frequency. (to avoid aliasing according to Nyquist's theorem)

Displaying the FFT Spectrum

Press the **MATH** button to display the Math Menu. Use the options to select the Source channel, Window algorithm, and FFT Zoom factor. You can display only one FFT spectrum at a time. You can select "Full screen" or "Split" in "Display" option to display FFT waveform on full screen or display channel waveform and its FFT waveform on half screen at a time.

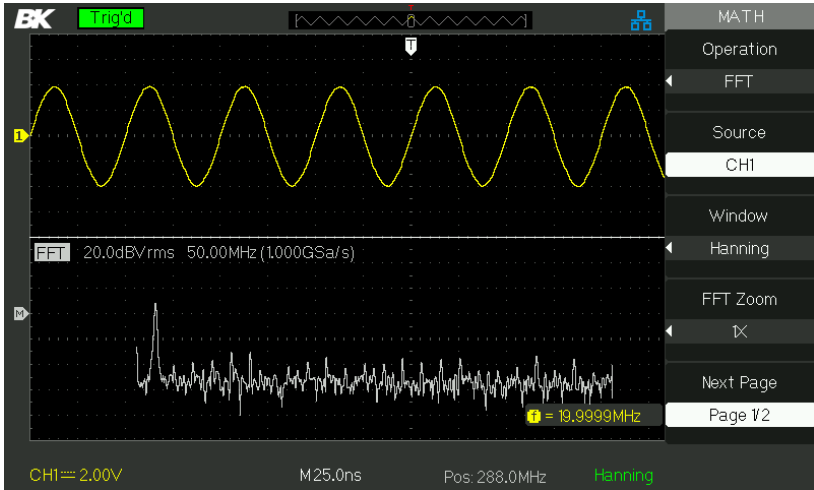

Figure 3.14 – FFT Function

Select FFT window

Windows reduce spectral leakage in the FFT spectrum. The FFT assumes that the YT waveform repeats forever. With an integral number of cycles, the YT waveform starts and ends at the same amplitude and there are no discontinuities in the signal shape. A non-integral number of cycles in the YT waveform causes the signal start and end points to be at different amplitudes. The transitions between the start and end points cause discontinuities in the signal that introduce high-frequency transients.

Table 3.13 – FFT Window Description

Window	Characteristics	Applications
Rectangular	Best frequency resolution, worst magnitude resolution. This is essentially the same as no window.	Symmetric transients or bursts. Equal-amplitude sine waves with fixed frequencies. Broadband random noise with a relatively slowly varying spectrum.

Hanning Hamming	Better frequency, poorer magnitude accuracy than Rectangular. Hamming has slightly better frequency resolution than Hanning.	Sine, periodic, and narrow-band random noise. Asymmetric transients or bursts.
Blackman	Best magnitude, worst frequency resolution.	Single frequency waveforms, to find higher order harmonics.

Magnifying the FFT Spectrum

You can magnify and use cursors to take measurements on the FFT spectrum. The oscilloscope includes an “FFT Zoom” option to magnify horizontally, press this option button to select “1X”, “2X”, “5X” or “10X”. Moreover, you also can turn the “Universal” knob to magnify FFT waveform horizontally in a 1-2-5 step. To magnify vertically, turn the “Volts/div” knob.

Measuring an FFT Spectrum Using Cursors

You can take two measurements on FFT spectrums: magnitude (in dB) and frequency (in Hz). Magnitude is referenced to 0 dB, where 0 dB equals 1 VRMS. You can use the cursors to take measurements at any zoom factor. Use horizontal cursors to measure amplitude and vertical cursors to measure frequency.

If you input a sine signal into channel 1, follow these steps:

- **Measure FFT Amplitude**
 1. Input a sine signal to channel 1, and press the “AUTO” button.
 2. Press the “MATH” button to enter the “MATH” menu.
 3. Press the “Operation” option button to select “FFT”.
 4. Press the “Source” option button to select “CH1”.
 5. Press CH1 button to display CH1 menu.

6. Turn the “Time/div” knob to adjust the sampling rate (at least double the frequency of input signal).
7. If FFT is displayed on full screen, press CH1 button again to remove channel waveform display.
8. Press the “CURSOR” button to enter “Cursor” menu.
9. Press the “Cursor Mode” button to select “Manual”.
10. Press the “Type” option button to select “Voltage”.
11. Press the “Source” option button to select “MATH”.
12. Press the “CurA” option button; turn the “Universal” knob to move Cursor A to the highest point of the FFT waveform.
13. Press the “CurB” option button, turn the “Universal” knob to move Cursor B to the lowest point of the FFT waveform.
14. The amplitude (ΔT) displays on the top of the left screen.

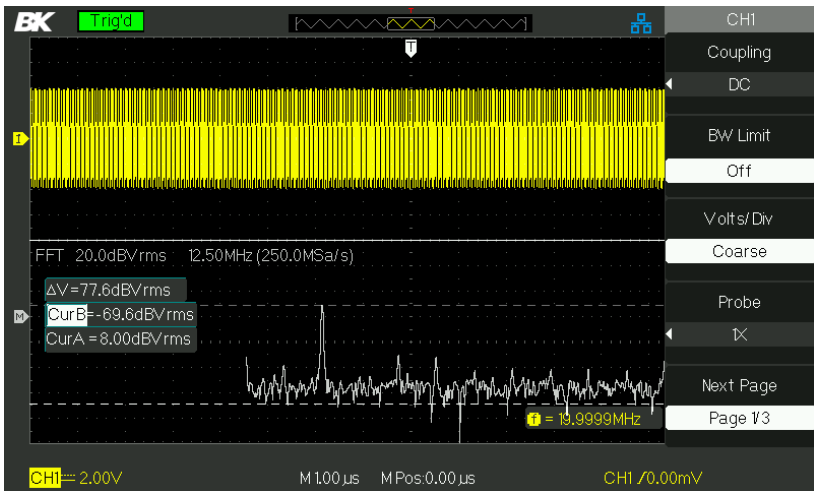

Figure 3.15 – Measuring FFT Amplitude

- **Measure FFT Frequency**
 1. Press the CURSOR button.
 2. Press the “Cursor Mode” button to select “Manual”.
 3. Press the “Type” option button to select “Time”.

4. Press the “Source” option button to select “MATH”.
5. Press the “CurA” option button, turn the “Universal” button to move Cursor A to the highest position of the FFT waveform.
6. The value of CurA displaying on the top of the left screen is FFT frequency. This frequency should be the same as input signal frequency.

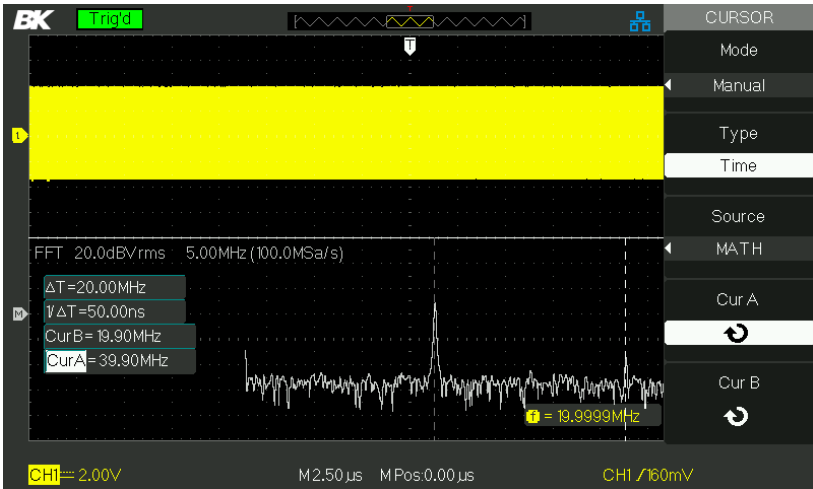

Figure 3.16 – Measuring FFT Frequency

NOTE:

The FFT of a waveform that has a DC component or offset can cause incorrect FFT waveform magnitude values. To minimize the DC component, choose AC Coupling on the source waveform.

To display FFT waveforms with a large dynamic range, use the dBVrms scale. The dBVrms scale displays component magnitudes using a log scale.

The Nyquist frequency is the highest frequency that any real-time digitizing oscilloscope can acquire without aliasing. This frequency is half that of the sample rate provided it is within the analog

bandwidth of the oscilloscope. Frequencies above the Nyquist frequency will be undersampled, which causes aliasing.

3.9 Using REF

The reference control saves waveforms to a nonvolatile waveform memory. The reference function becomes available after a waveform has been saved.

Table 3.14 – REF Function Menu

Option	Setting	Description
Source	CH1,CH2, CH1 off CH2 off	Choose the waveform display to store.
REFA REFB		Choose the reference location to store or recall a waveform.
Save		Stores source waveform to the chosen reference location.
REFA REFB	on off	Recall the reference waveform on the screen. Turn off the reference waveform.

Press the Ref button to display the “Reference waveform menu”.

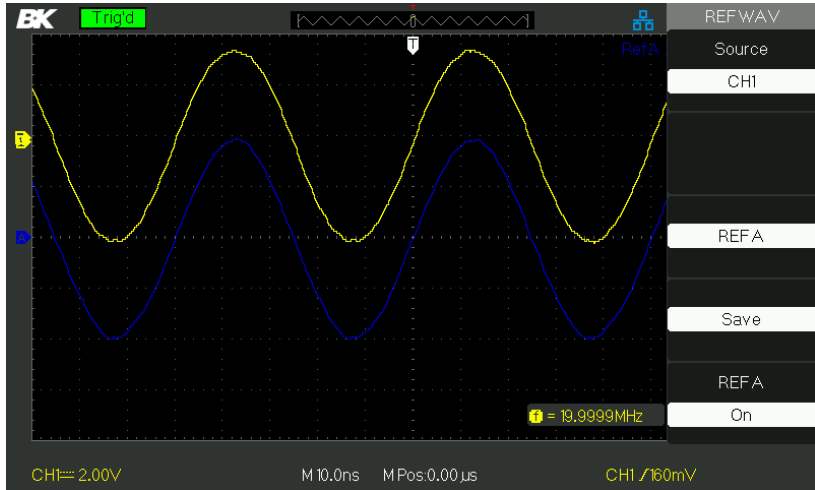

Figure 3.17 – Reference Waveform Menu

Operation step:

1. Press the “REF” menu button to display the “Reference waveform menu”.
2. Press the “Source” option button to select input signal channel.
3. Turn the vertical “POSITION” knob and “Volts/div” knob to adjust the vertical position and scale.
4. Press the third option button to select “REFA” or “REFB” as storage position.
5. Press the “Save” option button.
6. Press the bottom option button to select “REFA On” or “REFB On” to recall the reference waveform.

NOTE:

X-Y mode waveforms are not stored as reference waveforms.

You cannot adjust the horizontal position and scale of the reference waveform.

3.10 Horizontal System

Shown below are two knobs and one button in the HORIZONTAL area.



Figure 3.18 – Horizontal Controls

Table 3.15 – Horizontal System Function Menu

Option	Setting	Description
Delayed	On	Turn on this function for main time base waveform to display on the top half screen and window time base waveform to display on the below half screen at the same time.
	Off	Turn off this function to only display main time base waveform on the screen.

Horizontal Control Knob

You can use the horizontal controls to change the horizontal scale and position of waveforms. The horizontal position readout shows the time represented by the center of the screen, using the time of the trigger as

zero. Changing the horizontal scale causes the waveform to expand or contract around the screen center.

- **Horizontal “POSITION” knob**
 1. Adjust the horizontal position of all channels and math waveforms (the position of the trigger relative to the center of the screen). The resolution of this control varies with the time base setting.
 2. When you press the horizontal “POSITION” Knob, you can set the horizontal position to zero.
- **“Time/div” knob**
 1. Used to change the horizontal time scale to magnify or compress the waveform. If waveform acquisition is stopped (using the RUN/STOP or SINGLE button), turn the Time/div knob to expand or compress the waveform.
 2. Select the horizontal Time/div (scale factor) for the main or the window time base. When Window Zone is enabled, it changes the width of the window zone by changing the window time base.
- **Display scan mode**

When the Time/div control is set to 100 ms/div or slower and the trigger mode is set to Auto, the oscilloscope enters the scan acquisition mode. In this mode, the waveform display updates from left to right. There is no trigger or horizontal position control of waveforms during scan mode.

Window Zone

Use the Window Zone option to define a segment of a waveform to see more detail. This function behaves like zooming into a portion of the captured waveform. The window time base setting cannot be set slower than the Main time base setting.

You can turn the Horizontal Position and Time/div controls to enlarge or minimize waveforms in the Window Zone.

If you want to see a section of the waveform in details, follow these steps:

1. Press the “HORI MENU” button to enter the “Horizontal menu”.

2. Turn the “Time/div” knob to change the main time base scale.
3. Press the “Delayed” option button to select “On”.

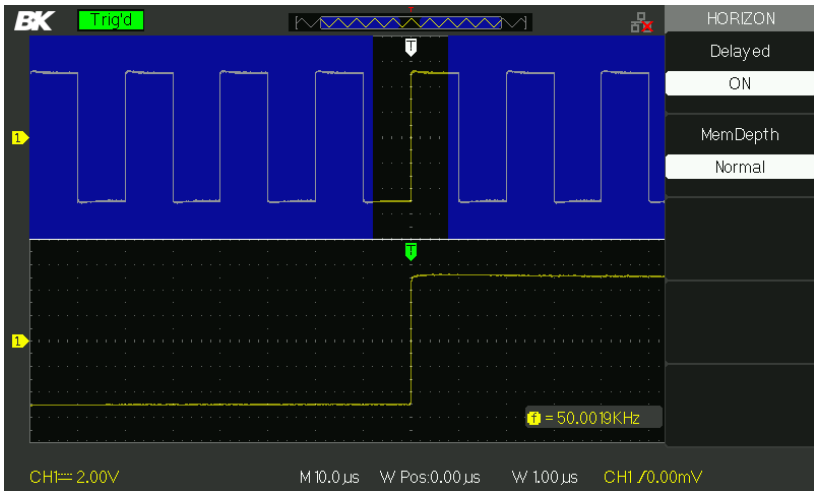

Figure 3.19 – Horizontal Delay Menu

4. Turn the “Horizontal Position” knob (adjust window’s position) to select the window that your need and expanded window waveform display on the below half screen at the same time.

3.11 Trigger System

The trigger determines when the oscilloscope starts to acquire data and display a waveform. When a trigger is set up properly, the oscilloscope converts unstable displays or blank screens into meaningful waveforms.

Here are three buttons and one knob in the trigger area. See below:



Figure 3.20 – Trigger Controls

- **“TRIG MENU” Button:** Press the “TRIG MENU” Button to display the “Trigger Menu”.
- **“LEVEL” Knob:** The LEVEL knob is to set the corresponding signal voltage of trigger point in order to sample. Press the “LEVEL” knob to set trigger level to zero.
- **“SET TO 50%” Button:** Use the “SET TO 50%” button to stabilize a waveform quickly. The oscilloscope can set the Trigger Level to be about halfway between the minimum and maximum voltage levels automatically. This is useful when you connect a signal to the EXT TRIG BNC and set the trigger source to Ext or Ext/5.
- **“FORCE Button:** Use the FORCE button to complete the current waveform acquisition whether the oscilloscope detects a trigger or not. This is useful for SINGLE acquisitions and Normal trigger mode.

Signal Source

You can use the Trigger Source options to select the signal that the oscilloscope uses as a trigger. The source can be any signal connected to a channel BNC, to the EXT TRIG BUS, or the AC power line (available only with Edge Trigger).



Trigger Type

The scopes have five trigger types: Edge, Video, Pulse, Slope, and Alternate.

Edge Trigger

Use Edge triggering to trigger on the edge of the oscilloscope input signal at the trigger threshold.

Table 3.16 – Edge Trigger Function Menu

Option	Setting	Description
Type	Edge	With Edge highlighted, the rising or falling edge of the input signal is used for the trigger.
Source	CH1 CH2	Triggers on a channel whether or not the waveform is displayed.
	EXT	Does not display the trigger signal; the Ext option uses the signal connected to the EXT TRIG front-panel BNC and allows a trigger level range of -1.2V to +1.2V.
	EXT/5	Same as Ext option, but attenuates the signal by a factor of five, and allows a trigger level range of +6V to -6V. This extends the trigger level range.
	AC Line	This selection uses a signal derived from the power line as the trigger source; trigger coupling is set to DC and the trigger level to 0 volts.
Slope		Trigger on Rising edge of the trigger signal.
		Trigger on Falling edge of the trigger signal.

	↑↓	Trigger on Rising edge and Falling edge of the trigger signal.
Mode	Auto	Use this mode to let the acquisition free-run in the absence of a valid trigger; This mode allows an untriggered, scanning waveform at 100 ms/div or slower time base settings.
	Normal	Use this mode when you want to see only valid triggered waveforms; when you use this mode, the oscilloscope does not display a waveform until after the first trigger.
	Single	When you want the oscilloscope to acquire a single waveform, press the “SINGLE” button.
Set up		Enter the “Trigger Setup Menu” (See Table 3.17).

Table 3.17 – Trigger Setup Function Menu

Option	Setting	Explain
Coupling	DC	Passes all components of the signal
	AC	Blocks DC components, attenuates signals below 50 Hz.
	HF Reject	Attenuates the high-frequency components above 150 kHz.
	LF Reject	Blocks the DC component, attenuates the low-frequency components below 7 kHz.
Holdoff 		Using the “universal” knob to adjust holdoff time (sec), the holdoff value is displayed.
Holdoff		Reset holdoff time to 100ns.

Reset		
Return		Return to the first page of “Trigger main menu”.

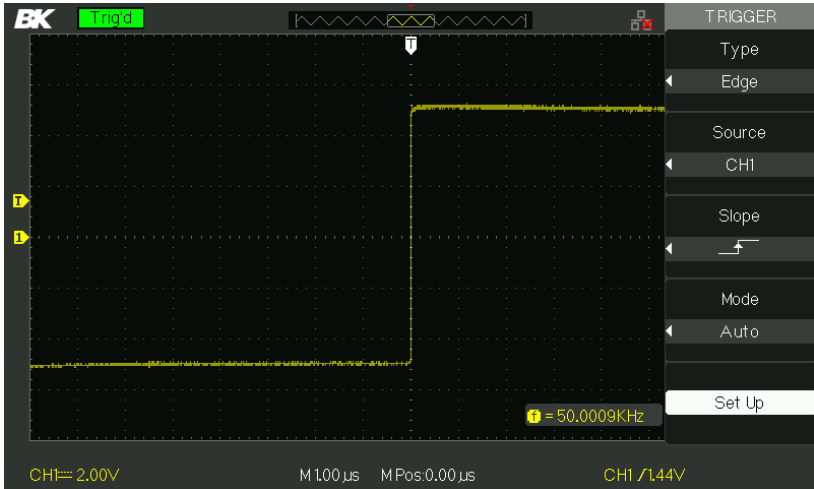

Figure 3.21 – Trigger Menu Screen

Operating Instructions:



1. Setup Type

- Press the “TRIG MENU” button to display “Trigger” menu.
- Press the “Type” option button to select “Edge”.

2. Set up Source

- According to the input signal, press the “Source” option button to select “CH1”, “CH2”, “EXT”, “EXT/5” or “AC Line”.

3. Set up Slope

- Press the “Slope” option button to select “”, “” or “”.

4. Set up Trigger mode

- Press the “Trigger mode” option button to select “Auto”, “Normal”, or “Single”.

Auto: The waveform refreshes at a high speed whether the trigger condition is satisfied or not.

Normal: The waveform refreshes when the trigger condition is satisfied and waits for next trigger event occurring when the trigger condition is not satisfied.

Single: The oscilloscope acquires a waveform when the trigger condition is satisfied and then stops

5. Set up Trigger coupling







- Press the “Set Up” button to enter the “Trigger Setup Menu”.
- Press the “Coupling” option button to select “DC”, “AC”, “HF Reject” or “LF Reject”.

Pulse Trigger

Use Pulse Width triggering to trigger on aberrant pulses.

Table 3.18 – Pulse Trigger Function Menu 1

Option	Setting	Description
Type	Pulse	Select the pulse to trigger the pulse match the trigger condition.
Source	CH1 CH2 EXT EXT/5 AC Line	Select input signal source.

When	 (Positive pulse width less than pulse width setting)  (Positive pulse width larger than pulse width setting)  (Positive pulse width equal to pulse width setting)  (Negative pulse width less than pulse width setting)  (Negative pulse width larger than pulse width setting)  (Negative pulse width equal to pulse width setting)	Select how to compare the trigger pulse relative to the value selected in the Set Pulse Width option.
Set Width	20.0ns~10.0s	Selecting this option can turn the universal to set up the pulse width.
Next Page	Page 1/2	Press this button to enter the second page.

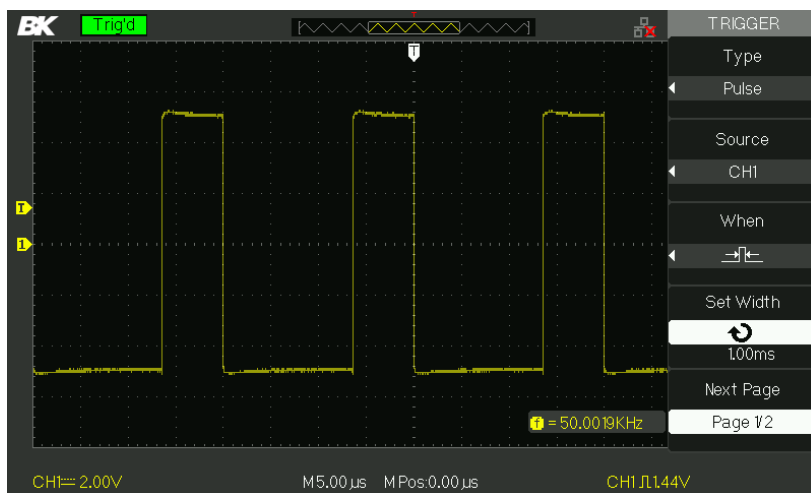

Figure 3.22 – Pulse Trigger Menu 1

Table 3.19 – Pulse Trigger Function Menu 2

Option	Setting	Description
Type	Pulse	Select the pulse to trigger the pulse match the trigger condition.
Mode	Auto Normal single	Select the type of triggering; Normal mode is best for most Pulse Width trigger applications.
Set up		Enter the “Trigger setup menu”.
Next Page	Page 2/2	Press this button to return to the first page.

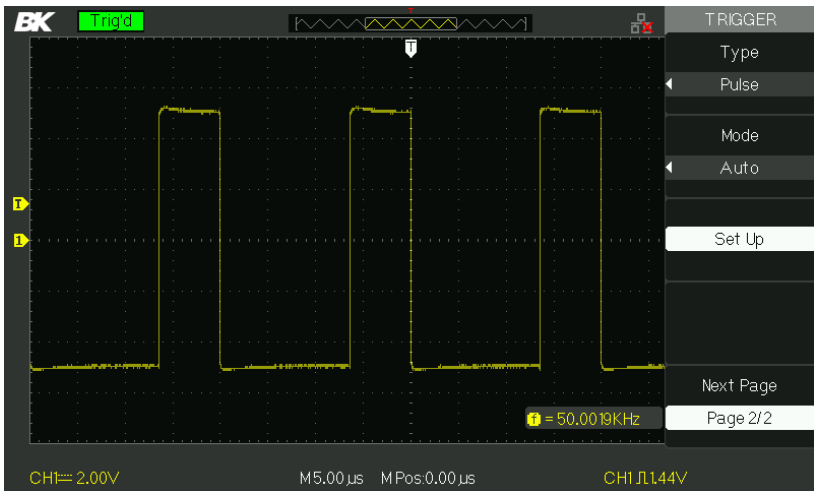







Figure 3.23 – Pulse Trigger Menu 2

Operating Instructions:

1. Setup Type

- Press the “TRIG MENU” button to display “Trigger” menu.

- Press the “Type” option button to select “Pulse”.
- 2. Set up condition**
- Press the “When” option button to select “”, “”, “”, “”, “” or “”.
- 3. Set up pulse width**
- Turn the “Universal” knob to set up width.

Video Trigger

Trigger on fields or lines of standard video signals.

Table 3.20 – Video Trigger Function Menu 1



Option	Setting	Description
Type	Video	When you select the video type, put the couple set to the AC, then you could trigger the NTSC, PAL and SECAM video signal.
Source	CH1 CH2	Select the input source to be the trigger signal.
	EXT EXT/5	Ext and Ext/5 use the signal applied to the EXT TRIG connector as the source.
Polarity	 (Normal)	Normal triggers on the negative edge of the sync pulse.
	 (Inverted)	Inverted triggers on the positive edge of the sync pulse.
Sync	Line Num All lines Odd field Even Field	Select appropriate video sync.
Next Page	Page 1/2	Enter the second page of “Video trigger menu”.

Table 3.21 - Video Trigger Function Menu 2

Option	Setting	Description
Type	Video	When you select the video type, put the couple set to the AC, then you could trigger the NTSC, PAL and SECAM video signal.
Standard	NTSC Pal/Secam	Select the video standard for sync and line number count.
Mode	Auto	Use this mode to let the acquisition free-run in the absence of a valid trigger; This mode allows an untriggered, scanning waveform at 100 ms/div or slower time base settings.
	Normal	Use this mode when you want to see only valid triggered waveforms; when you use this mode, the oscilloscope does not display a waveform until after the first trigger.
	Single	When you want the oscilloscope to acquire a single waveform, press the "SINGLE" button.
Set up		Enter the "Trigger setup menu".
Next Page	Page 2/2	Return to the first page of "Video Trigger menu".

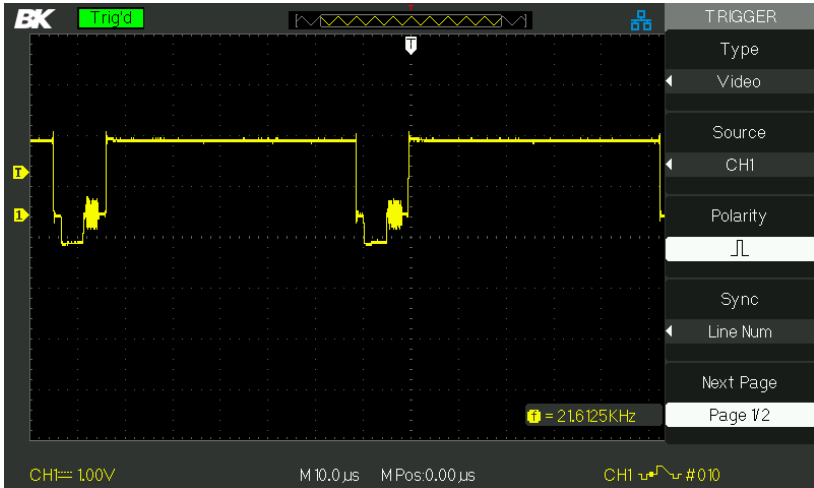



Figure 3.24 – Video Trigger Menu

Operating Instructions:

1. Set up Type

- Press the “TRIG MENU” button to display “Trigger” menu.
- Press the “Type” option button to select “Video”.

2. Set up Polarity

- Press the “Polarity” option button to select “” or “”.

3. Set up Synchronization

- Press the “Sync” option button to select “All Lines”, “Line Num”, “Odd Field”, and “Even Field”.
- If you select “Line Num”, you can turn the “Universal” knob to set the appointed line number.



4. Set up Standard

- Press the “Next Page - Page 2/2” option
- Press the “Standard” option button to select “PAL/SECAM” or “NTSC”.

Slope Trigger

Trigger on positive slope or negative slope of waveform, according to setup time of the oscilloscope.

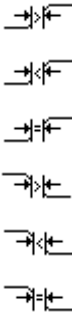
Table 3.22 – Slope Trigger Function Menu 1

Option	Setting	Instruction
Type	Slope	Trigger on positive slope of negative slope according to setup time of the oscilloscope.
Source	CH1 CH2 EXT EXT/5	Select trigger source.
When		Select trigger condition.
Time	 <Set time>	Turn the “Universal” knob to set slope time. Time setup range is 20ns-10s.
Next Page	Page 1/2	Enter the second page of slope trigger.

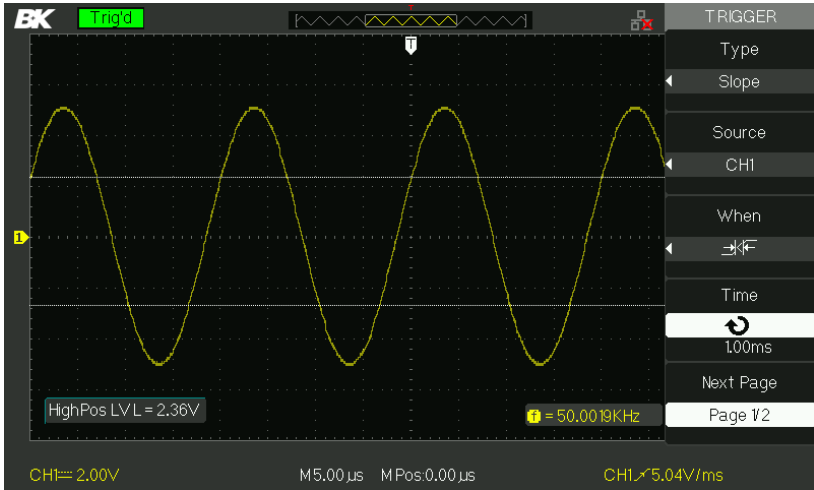
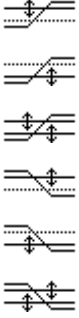

Figure 3.25 – Slope Trigger Menu 1

Option	Setting	Instruction
Type	Slope	Trigger on positive slope or negative slope according to setup time of the oscilloscope.
Vertical		Select the trigger level that can be adjusted by "LEVEL" knob. You can adjust "LEVEL A", "LEVEL B" or adjust them at the same time.
Mode	Auto	Use this mode to let the acquisition free-run in the absence of a valid trigger; This mode allows an untriggered, scanning waveform at 100 ms/div or slower time base settings.

	Normal	Use this mode when you want to see only valid triggered waveforms; when you use this mode, the oscilloscope does not display a waveform until after the first trigger.
	Single	When you want the oscilloscope to acquire a single waveform, press the “SINGLE” button.
Set up		Enter “Trigger setup menu” (See Table 3.17).
Next Page	Page 2/2	Return to the first page of slope trigger.

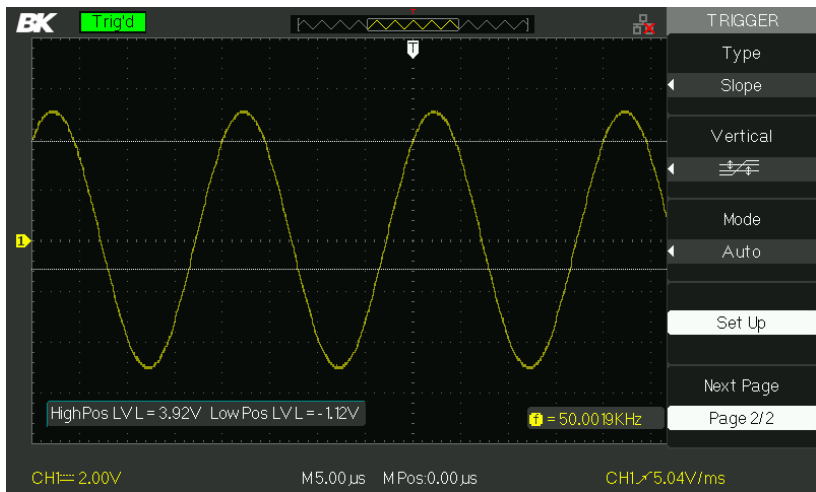









Figure 3.26 – Slope Trigger Menu 2

Operating Instructions:

Follow the next steps after “Slope Trigger” is selected:

1. Input a signal to CH1 or CH2.
2. Press the “AUTO” button.
3. Press the “TRIG MENU” button to enter “Trigger menu”.

4. Press the “Type” option button to select “Slope”.
5. Press the “Source” option button to select “CH1” or “CH2”.
6. Press the “When” option button to select “”, “”, “”, “”, “”, “” and “”.
7. Press the “Time” button, turn the “Universal” knob to adjust slope time.
8. Press the “Next Page - Page 1/2” option button to enter the second page of the “Slope trigger menu”.
9. Press the “Vertical” option button to select trigger level that can be adjusted.
10. Turn the “LEVEL” knob.

Alternate Trigger

The trigger signal comes from two vertical channels when you use alternate trigger. In this mode, you can observe two irrelative signals at the same time. You can select different trigger types for two vertical signals, and selected types cover edge, pulse, video and slope trigger. Trigger information of two channel signals display on the bottom right of the screen.

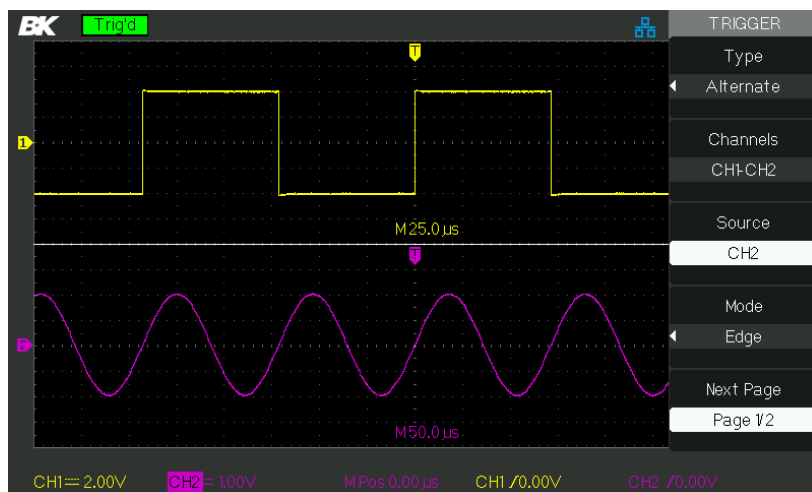

Figure 3.27 – Alternate Trigger Menu

Table 3.23 – Alternate Trigger Edge Mode Function Menu 1

Option	Setting	Description
Type	Alternate	When using alternate trigger, the triggered signal comes from two vertical channels. In this mode, you can observe two irrelative signals at a time.
Channels	CH1-CH2	Set the trigger channels
Source	CH1 CH2	Set trigger type information for CH1 signal Set trigger type information for CH2 signal
Mode	Edge	Set trigger type of vertical channel signal to edge
Next Page	Page 1/2	Go to the second page of the TRIGGER Menu.

Table 3.24 – Alternate Trigger Edge Mode Function Menu 2

Option	Setting	Description
Slope		Triggering on rising edge. Triggering on falling edge. Triggering on rising edge and falling edge.
Set up	/	Enter "Trigger setup menu" (See Table 3.17).
Next Page	Page 2/2	Go to the back to the first page of the TRIGGER Menu.

Table 3.25 – Alternate Trigger Pulse Mode Function Menu 1

Option	Setting	Description
Type	Alternate	The trigger signal comes from two vertical channels when you use alternative trigger. In this mode, you can observe two irrelative signals at the same time.
Channels	CH1-CH2	Set the trigger channels
Source	CH1 CH2	Set trigger type information for CH1 signal Set trigger type information for CH2 signal
Mode	Pulse	Set trigger type of the vertical channel signal to Pulse trigger.
Next Page	Page 1/2	Enter the second page of Alternative trigger menu.

Table 3.26 – Alternate Trigger Pulse Mode Function Menu 2

Option	Setting	Description
When		Select how to compare the trigger pulse relative to the value selected in the Set Pulse Width option.
Set Width	20.0ns-10.0s	Selecting this option can turn the universal to set up the pulse width.

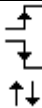
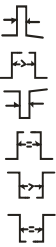

Set up		Enter the “Trigger Setup Menu” (See Table 3.17).
Next Page	Page 2/2	Press this button to return to the first page.

Table 3.27 – Alternate Trigger Video Mode Function Menu 1

Option	Setting	Description
Type	Alternative	The trigger signal comes from two vertical channels when you use alternative trigger. In this mode, you can observe two irrelative signals at the same time.
Channels	CH1-CH2	Set the trigger channels
Source	CH1 CH2	Set trigger type information for CH1 signal Set trigger type information for CH2 signal
Mode	Video	Set trigger type of the vertical channel signal to Video trigger.
Next Page	Page 1/2	Enter the second page of Alternative trigger menu.

Table 3.28 – Alternate Trigger Video Mode Function Menu 2

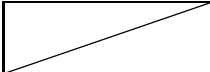

Option	Setting	Description
Polarity	 (Normal)  (Inverted)	Normal triggers on the negative edge of the sync pulse. Inverted triggers on the positive edge of the sync pulse.

Sync	Line Num All lines Odd field Even Field	Select appropriate video sync.
Standard	NTSC Pal/Secam	Select the video standard for sync and line number count.
Set up		Enter the "Trigger Setup Menu" (See Table 3.17).
Next Page	Page 2/2	Press this button to return to the first page.

Table 3.29 – Alternate Trigger Slope Mode Function Menu 1

Option	Setting	Description
Type	Alternative	The trigger signal comes from two vertical channels when you use alternative trigger. In this mode, you can observe two irrelative signals at the same time.
Channels	CH1-CH2	Set the trigger channels
Source	CH1 CH2	Set trigger type information for CH1 signal Set trigger type information for CH2 signal
Mode	Slope	Set trigger type of the vertical channel signal to slope trigger.
Next Page	Page 1/2	Enter the second page of the alternative trigger.

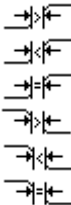
Table 3.30 – Alternate Trigger Slope Mode Function Menu 2

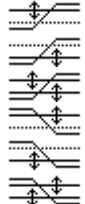
Option	Setting	Description
When		Select slope trigger condition.
Time	 <Set time>	Turn the “Universal” knob to set the slope time. Time setup range is 20ns-10s.
Vertical		Select the trigger level that can be adjusted by “LEVEL” knob. You can adjust “LEVEL A”, “LEVEL B” or adjust them at the same time.
Set up	/	Enter “Trigger setup menu” (See Table 3.17).
Next Page	Page 2/2	Return to the first page of “Alternative trigger menu”.

Operating Instructions:

To use alternate triggering, follow these steps:

1. Input two irrelative signals to channel 1 and channel 2.
2. Press the AUTO button.
3. Press the TRIG MENU button to enter “trigger menu”.
4. Press the “Type” option button to select “Alternative”.
5. Press the “Channels” option button to select “CH1-CH2”

6. Press the “Source” option button to select “CH1”.
7. Press the CH1 button and turn the “Time/div” knob to optimize waveform display.
8. Press “Mode” option button to select “Edge”, “Pulse”, “Slope” or “Video”.
9. Set the trigger according to trigger edge.
10. Press the “Source” option button to select “CH2”.
11. Press the CH2 button and turn the “Time/div” knob to optimize waveform display.
12. Repeat steps 8 and 9.

Coupling

Use “Coupling” to make sure the signal passes through the trigger circuit. It is useful for obtaining a steady waveform.

If you use trigger coupling, you should press the “TRIG MENU” button and then select “Edge”, “Pulse”, “Video”, or “Slope” trigger. Then select the “Coupling” option in the “Set Up menu”.

Position

The horizontal position control establishes the time between the trigger position and the screen center. You can adjust the horizontal “POSITION” knob control to view waveform data before the trigger, after the trigger, or some of each. When you change the horizontal position of a waveform, you are changing the time between the trigger and the center of the display actually. (This appears to move the waveform to the right or left on the display.)

Slope and Level

The Slope and Level controls help to define the trigger. The Slope option (Edge trigger type only) determines whether the oscilloscope finds the trigger point on the rising and/or the falling edge of a signal.

The TRIGGER LEVEL knob controls at what point on the edge the trigger occurs.

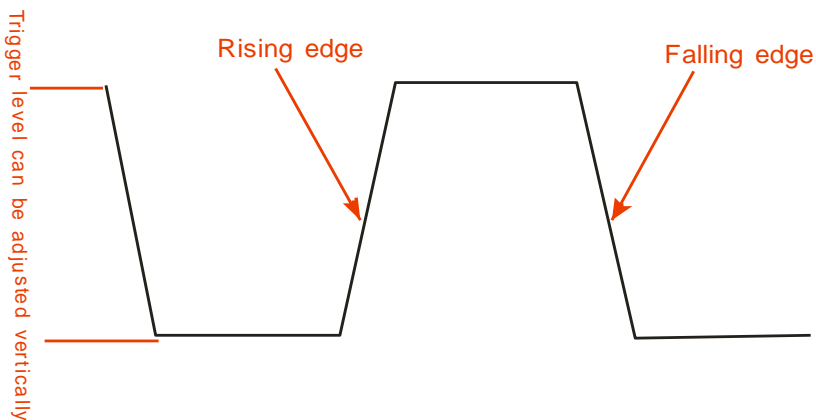

Figure 3.28 – Rising and Falling Edge Illustration

NOTE: Press the SINGLE button when you want the oscilloscope to acquire a single waveform.

Trigger coupling affects only the signal passed to the trigger system. It does not affect the bandwidth or coupling of the signal displayed on the screen.

Normal Polarity Sync triggers always occur on negative-going horizontal sync pulses. If the video waveform has positive-going horizontal sync pulses, use the Inverted Polarity selection.

Trigger Holdoff

You can use the Trigger Holdoff function to produce a stable display of complex waveforms. Holdoff is time between when the oscilloscope detects one trigger and when it is ready to detect another. The oscilloscope will not trigger during the holdoff time. For a pulse train, you can adjust the holdoff time so the oscilloscope triggers only on the first pulse in the train.

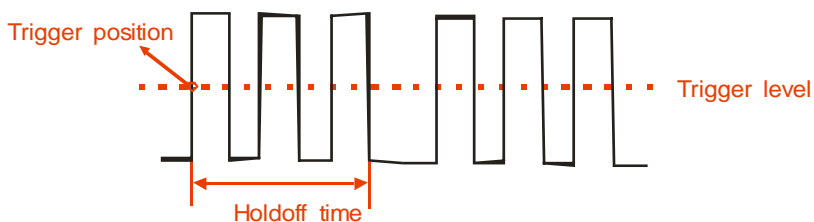

Figure 3.29 – Trigger Holdoff Illustration

If you want to change holdoff time, please follow the steps below:

1. Press the “TRIG MENU” button to show the “TRIG Menu”.
2. Press the “Type” option button to select trigger type.
3. Press the “Set Up” option button to enter the “Trigger setup menu”.
4. Press the “Holdoff” option button and turn the “Universal” knob to change the holdoff time until the waveform triggers steadily.

NOTE: Use trigger holdoff to help stabilize the display of aperiodic waveforms.

3.12 Signal Acquisition System

Shown below is the “ACQUIRE” button for entering the menu for “Acquiring Signals”.

Table 3.31 – Acquire Function Menu

Option	Setting	Description
Acquisition	Sampling	Use for sampling and accurately display most of the waveform.
	Peak Detect	Detect the noise and decrease the possibility of aliasing.
	Average	Use to reduce random or uncorrelated noise in the signal display.
	Averages (4, 16, 32, 64, 128, 256)	Select number of averages.
Sinx/x	Sinx x	Use sin interpolation Use linear interpolation
Mode	Equ time	Set the Sampling mode to Equivalent time.
	Real time	Set the Sampling mode to Real time.
Sa Rate		Displays system sampling rate.

When you acquire a signal, the oscilloscope converts it into digital form and displays a waveform. The acquisition mode defines how the signal is digitized and the time base setting affects the time span and level of detail in the acquisition.

- **Sampling:** In this acquisition mode, the oscilloscope samples the signal in evenly spaced intervals to construct the waveform. This mode accurately represents signals most of the time.
Advantage: You can use this mode to reduce random noise.

Disadvantage: This mode does not acquire rapid variations in the signal that may occur between samples. This can result in aliasing may cause narrow pulses to be missed. In these cases, you should use the Peak Detect mode to acquire data.

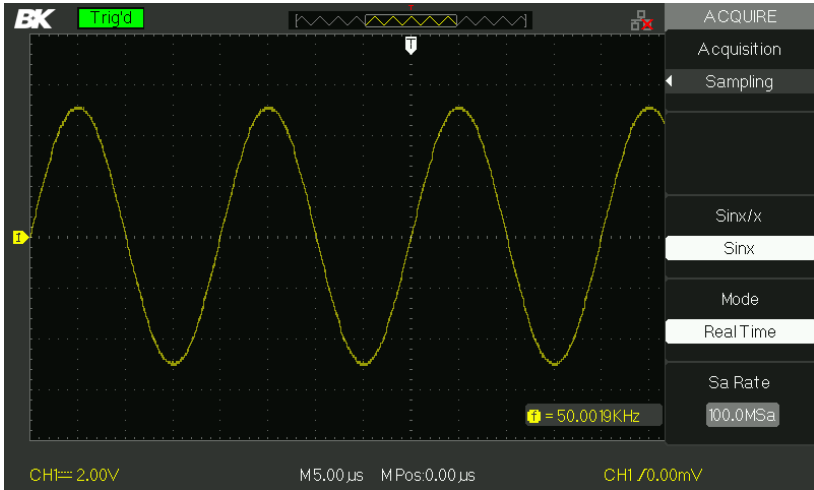

Figure 3.30 – Acquire Menu

- **Peak Detect:** Peak Detect mode capture the maximum and minimum values of a signal Finds highest and lowest record points over many acquisitions.
Advantage: In this way, the oscilloscope can acquire and display narrow pulses, which may have otherwise been missed in Sample mode.
Disadvantage: Noise will appear to be higher in this mode.

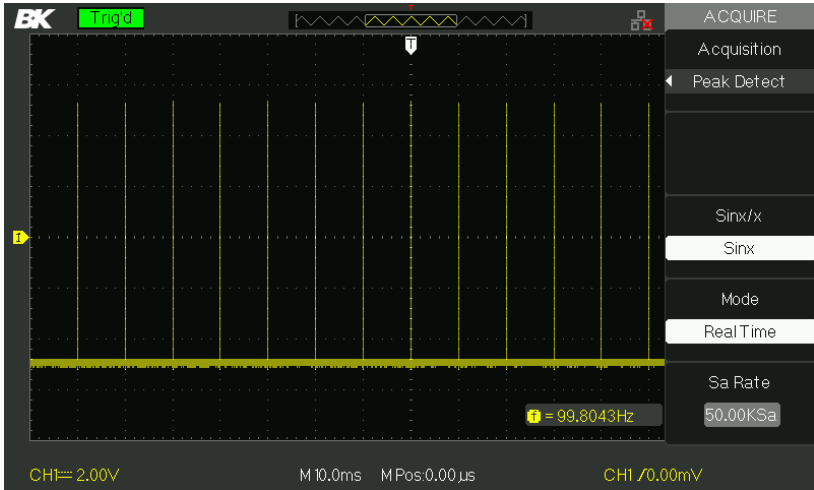

Figure 3.31 – Peak Detect

- **Average:** The oscilloscope acquires several waveforms, averages them, and displays the resulting waveform.
Advantage: You can use this mode to reduce random noise.

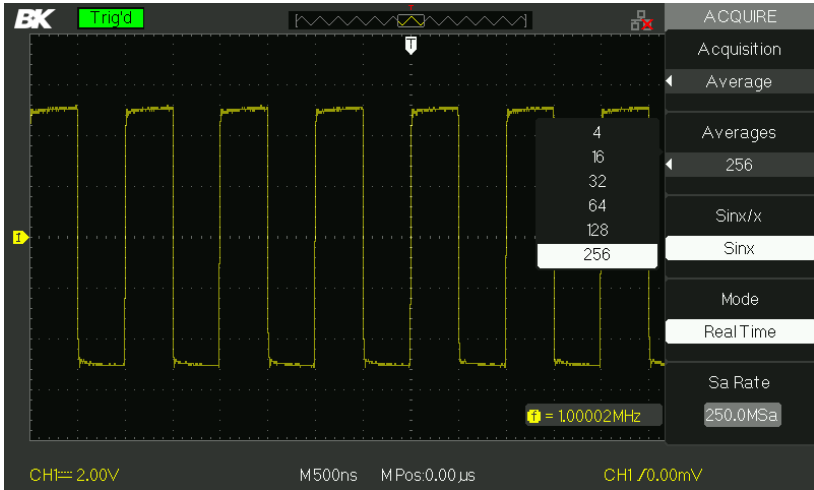

Figure 3.32 – Average Acquisition

- **Equivalent Time Sampling:** The equivalent time sampling mode can achieve up to 20 ps of horizontal resolution (equivalent to 50GSa/s). This mode is good for observing repetitive waveforms.
- **Real Time Sampling:** The scope has a maximum Real-time sampling rate of 1GSa/s.
- **“RUN/STOP” Button:** Press the RUN/STOP button when you want the oscilloscope to acquire waveforms continuously. Press the button again to stop the acquisition.
- **“SINGLE” Button:** Press the SINGLE button to acquire a single waveform. Each time you push the SINGLE button, the oscilloscope begins to acquire another waveform. After the oscilloscope detects a trigger it completes the acquisition and stops.

When you push the RUN/STOP or SINGLE buttons to start an acquisition, the oscilloscope goes through the following steps:

1. Acquire enough data to fill the portion of the waveform record to the left of the trigger point. This is also called the pre-trigger.

2. Continue to acquire data while waiting for the trigger condition to occur.
 3. Detect the trigger condition.
 4. Continue to acquire data until the waveform record is full.
 5. Display the newly-acquired waveform.
- **Time Base:** The oscilloscope digitizes waveforms by acquiring the value of an input signal at discrete points. The time base allows you to control how often the values are digitized. To adjust the time base to a horizontal scale that suits your purpose, use the Time/div knob.
 - **Time Domain Aliasing:** Aliasing occurs when the oscilloscope does not sample the signal fast enough to construct an accurate waveform record. When this happens, the oscilloscope displays a waveform with a frequency lower than the actual input waveform, or triggers and displays an unstable waveform.

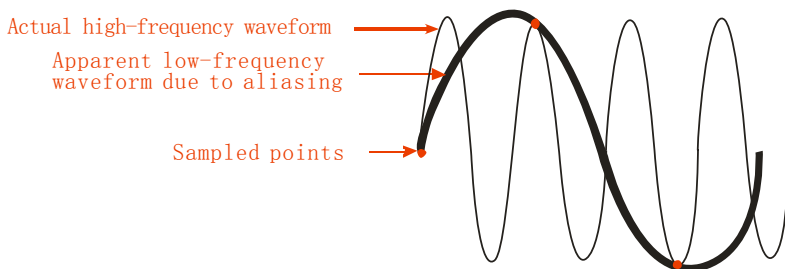

Figure 3.33 – Time Domain Aliasing Illustration

Operating Instructions:

Set up Sampling Format

You can press the “Acquisition” option button or turn the “Universal” knob to select “Sampling” mode, “Peak Detect” mode or “Average” mode.

Set up Averages

When you select “Average” format, you can press the “Averages” option button to select “4”, “16”, “32”, “64”, “128” or “256”.

Set up function interpolation

You can select Sinx interpolation or linear interpolation.

Set up Sampling Mode

Press the “Mode” option button to select “Real Time” or “Equ Time”.



Set up Sampling Rate

The sampling rate is based on the time division scaling on the screen. Adjust the sampling rate by turning the Time/div front panel knob. The sampling rate is shown under the “Sa Rate” display.

3.13 Display System

The display function can be setup by pressing the “DISPLAY” button.

Table 3.32 – Display System Menu 1

Option	Setting	Description
Type	Vectors Dots	Vectors fill the space between adjacent sample points in the display. There is no link between adjacent sample points.
Persist	Off 1 sec 2 sec 5 sec Infinite	Sets the length of time each displayed sample point remains displayed.
Intensity	 <Intensity>	Set waveforms' intensity.
Brightness	 <Brightness>	Set grid brightness.
Next Page	Page 1/3	Press this button to enter second page.

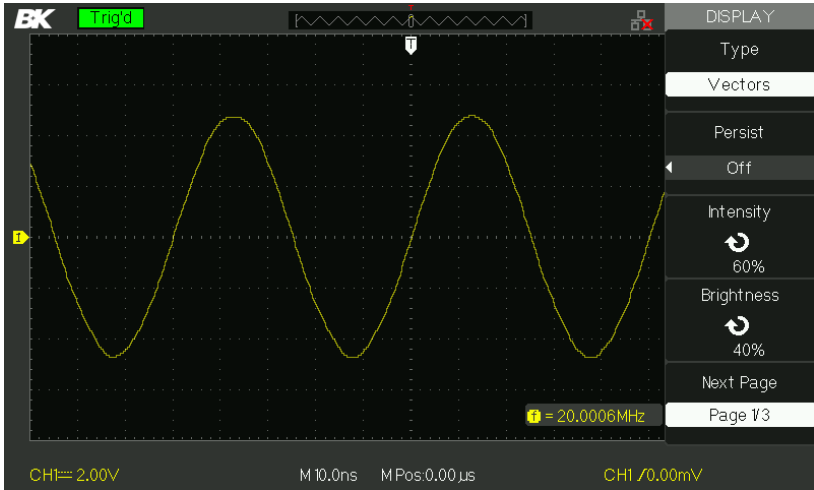





Figure 3.34 – Display Menu 1

Table 3.33 – Display System Menu 2

Option	Setting	Description
Format	YT XY	YT format displays the vertical voltage in relation to time (horizontal scale). XY format displays a dot each time a sample is acquired on channel 1 and channel 2
Screen	Normal Inverted	Set to normal mode. Set to invert color display mode.
Grid	  	Display grids and axes on the screen. Turn off the grids. Turn off the grids and axes.
Menu Display	2sec 5sec 10sec	Set menu display time on screen.

	20sec Infinite	
Next Page	Page 2/3	Press this button to enter the second page of "Display menu".

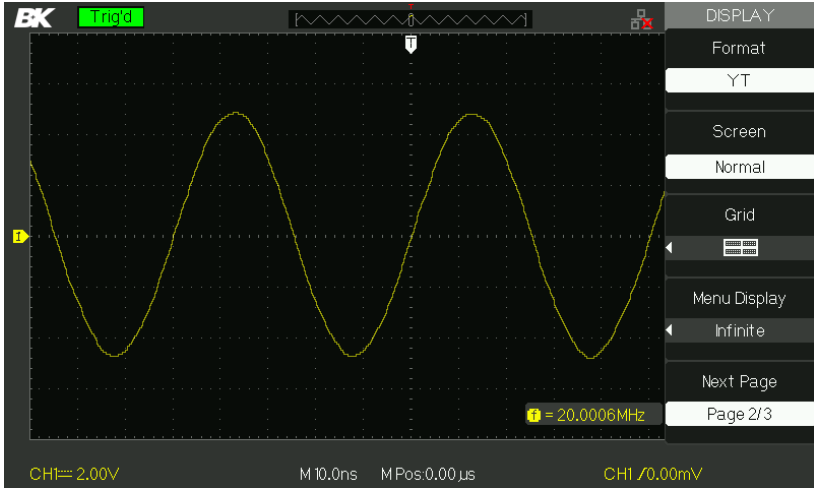

Figure 3.35 – Display Menu 2

Table 3.34 – Display System Menu 3

Option	Setting	Description
Skin	Classical Modern Tradition Succinct	Set up screen style.
Next Page	Page 3/3	Press this button to return to the first page.

Operating Instructions:

Set up waveform display type

1. Press the “DISPLAY” button to enter the “Display” menu.
2. Press the “Type” option button to select “Vectors” or “Dots”.

Set up Persist

Press “Persist” option button to select “Off”, “1 Sec”, “2 Sec”, “5 Sec” or “Infinite”. You can use this option to observe some special waveforms.

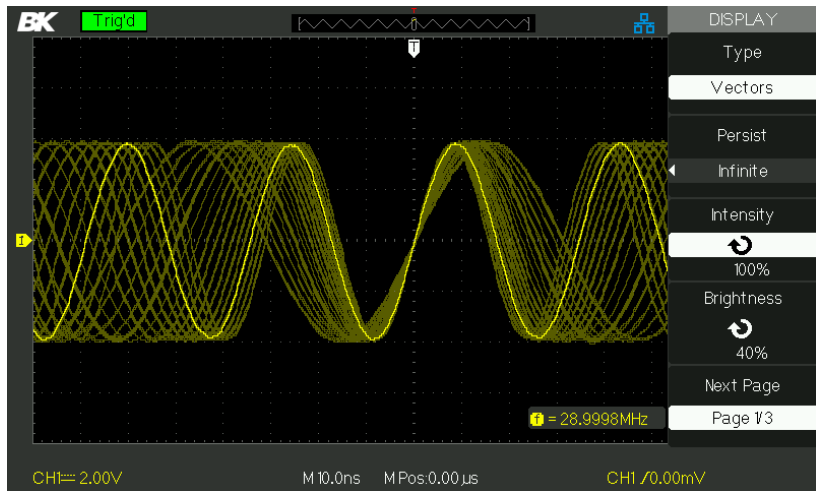

Figure 3.36 – Persist Screen

Set up Intensity

Press the “Intensity” option button and turn the “Universal” knob to adjust waveforms’ intensity.

Set up Brightness

Press the “Brightness” option button and turn the “Universal” knob to adjust grid brightness.



Set up display format

1. Press the “Next Page” option button to enter second display menu.
2. Press the “Format” option button to select “YT” or “XY”.

Set up Screen

Press the “Screen” option button to select “Normal” or “Inverted” to set the screen display color.

Set up Grid

Press the “Grid” option button to select “”, “” or “” to set the screen whether display grid or not.

Set up Menu Display

Press the “Menu Display” option button to select “2 sec”, “5sec”, “10sec”, “20sec” or “Infinite” to set menu display time on screen.

Set Skin

Press the “skin” option button or turn the “Universal” knob to select “Classical”, “Modern”, “Traditional” or “Succinct”.

X-Y Format

Use the XY format to analyze phase differences, such as those represented by Lissajous patterns. The format plots the voltage on channel 1 against the voltage on channel 2, where channel 1 is the horizontal axis and channel 2 is the vertical axis. The oscilloscope uses the untriggered Sample acquisition mode and displays data as dots.

NOTE: The oscilloscope can capture a waveform in normal YT mode at any sampling rate. You can view the same waveform in XY mode.

To do so, stop the acquisition and change the display format to XY.

Operation steps:

- Channel 1 “Volt/div” and vertical “POSITION” set up the horizontal scale and position.
- Channel 2 “Volt/div” and vertical “POSITION” set up the horizontal scale and position.
- Turn the “Time/div” knob to adjust the sampling rate
- The following functions are forbidden in XY display form:
 - Benchmark wave form and wave mathematic
 - Cursor
 - Auto (resets display format to YT)
 - Trigger Control

- Horizontal Position Knob
- Vector Display Type
- Scan Display

3.14 Measure System

The oscilloscope displays the voltage in relation to time and tests the waveform displayed. Different measurement techniques such as scale, Cursor and auto measure modes are used.

NOTE: The CURSORS and MEASURE buttons can be disabled. Please see “Education Mode” for details.

Scale Measurement

This method allows you to make a quick, visual estimate. For example, you might look at waveform amplitude and determine that it is a little more than 100 mV. You can take simple measurements by counting the major and minor graticule divisions involved and multiplying by the scale factor. For example, if you counted five major vertical graticule divisions between the minimum and maximum values of a waveform and knew you had a scale factor of 100 mV/div, then you could easily calculate your peak-to-peak voltage as follows:

$$5 \text{ divisions} \times \frac{100 \text{ mV}}{\text{division}} = 500 \text{ mV}$$



Cursor Measurement

Press the “CURSORS” button to display the “Cursor” menu.

The cursor measurement has three modes: Manual, Track, and Auto Measure.

Manual Mode

Table 3.35 – Manual Cursor Menu

Option	Setting	Description
Cursor Mode	Manual	In this menu, set the manual cursor measure.
Type	Voltage Time	Use cursor to measure voltage parameters. Use cursor to measure time parameters.
Source	CH1 CH2 MATH REFA REFB	Select input signal channel.
Cur A 		Select this option, use “Universal” knob to adjust cursor A.
Cur B 		Select this option, use “Universal” knob to adjust cursor B.

In this mode, the screen displays two horizontal parallel cursors or vertical parallel cursors to measure voltage or time. You can move the cursor by turning the “Universal” knob. Before using cursors, you should make sure that you have set the signal source as the channel for measuring.

- **Voltage Cursor:** Voltage cursors appear as horizontal lines on the display and measure the vertical parameters.
- **Time Cursor:** Time cursors appear as vertical lines on the display and measure the horizontal parameters.
- **Cursor Moving:** Use the “universal” knob to move cursor 1 and cursor 2. They could be moved when the corresponding cursor option are selected, and cursor value will display on the bottom left and top left of the screen when you move the cursor.

To do manual cursor measurements, follow these steps:

1. Press CURSOR button to enter the cursor function menu.
2. Press the "Cursor Mode" option button to select "Manual".
3. Press the "Type" option button to select "Voltage" or "Time".
4. Press the "Source" option button to select "CH1", "CH2", "MATH", "REFA", or "REFB" according to input signal channel.
5. Select "Cur A", turn the "Universal" knob to adjust Cursor A.
6. Select "Cur B", turn the "Universal" knob to adjust Cursor B.
7. The measurement values are displayed on the top of the left corner.

If the measurement type is set to "Voltage", the values are as followed:

- The voltage increment between Cursor A and Cursor B: ΔV
- The value of Cur A: CurA
- The value of Cur B: Cur B

If the measurement type is set to "Time", the values are as followed:

- The time increment between Cursor A and Cursor B: ΔT
- The reciprocal of time increment between Cursor A and Cursor B: $1/\Delta T$
- The value of Cur A: CurA
- The value of Cur B: Cur B

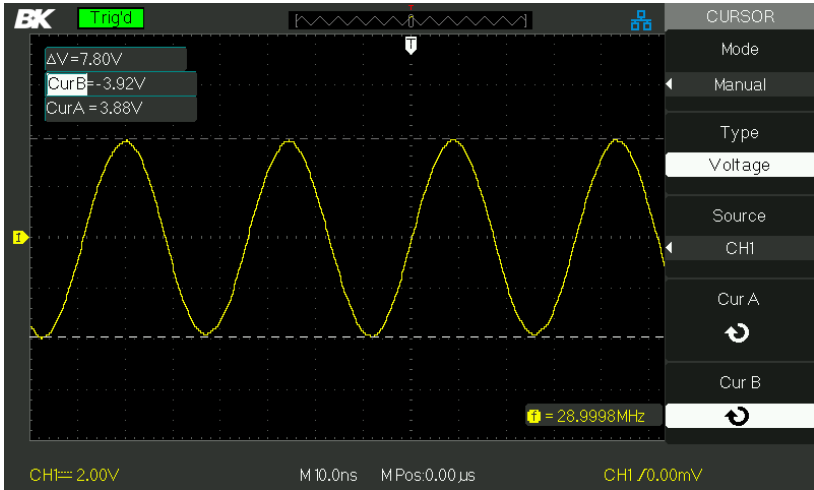

Figure 3.37 – Cursor Menu (Manual)

Track Mode

Table 3.36 – Track Mode Menu

Option	Setting	Description
Cursor Mode	Track	In this mode, set track cursor measure.
Cursor A	CH1 CH2 NONE	Set the input signal channel that the Cursor A will measure.
Cursor B	CH1 CH2 NONE	Set the input signal channel that the Cursor B will measure.
Cur A ↻		Select this option, turn the “Universal” knob to adjust horizontal coordinate of Cursor A.
Cur B ↻		Select this option, turn the “Universal” knob to adjust horizontal coordinate of Cursor B.

In this mode, the screen displays two cross cursors. The cross cursor sets the position on the waveform automatically. You could adjust cursor's horizontal position on the waveform by turning the "Universal" knob. The oscilloscope displays the values on the top left of the screen.

To do track cursor measurement, follow these steps:

1. Press CURSOR button to enter the cursor measure function menu.
2. Press the "Cursor Mode" option button to select "Track".
3. Press the "Cursor A" option button to select the input signal channel.
4. Press the "Cursor B" option button to select the input signal channel.
5. Select "Cur A", turn the "Universal" knob to move Cursor A horizontally.
6. Select "Cur B", turn the "Universal" knob to move Cursor B horizontally.
7. The measurement values are displayed on the top left of the screen:

A→T: The horizontal position of Cursor A (Time cursor centered around the midpoint of screen).

A→V: The Vertical position of Cursor A (Voltage cursor centered around channel ground level).

B→T: The horizontal position of Cursor B (Time cursor centered around the midpoint of screen).

B→V: The Vertical position of Cursor B (Voltage cursor centered around channel ground level).

ΔT : Horizontal space between Cursor A and Cursor B (Time value between two cursors).

$1/\Delta T$: The reciprocal of horizontal space between cursor A and cursor B.

ΔV : Vertical space between Cursor A and Cursor B (Voltage value between two cursors).

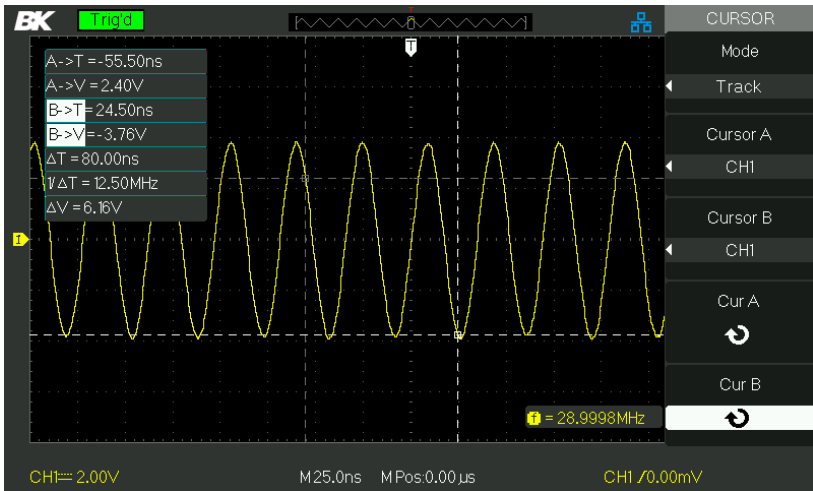

Figure 3.38 – Cursor Menu (Track)

Auto Mode

This mode will take effect with automatic measurements. The instruments will display cursors while measuring parameters automatically. These cursors demonstrate the physical meanings of these measurements.

To do auto cursor measurements, follow these steps:

1. Press the CURSOR button to enter “Cursor measure menu”.
2. Press the “Cursor Mode” option button to select “Auto”.
3. Press the “MEASURE” button to enter “Auto cursor measure mode menu” to select the parameter that you want to measure.

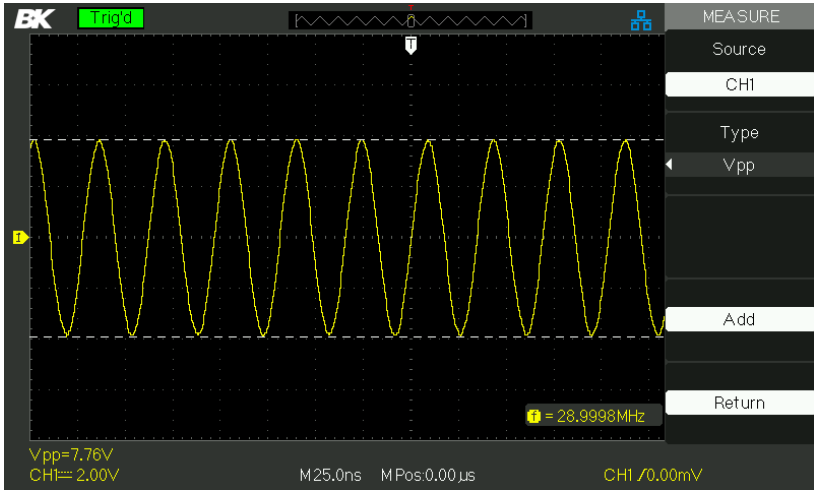

Figure 3.39 – Auto Mode

Auto Measurement

When you take automatic measurements, the oscilloscope does all the calculation for you. The measurements use all the recorded points in the memory, which are more accurate than measurements made using the graticule lines or cursor measurements because these measurements are confined to be made by only using points on the display and not all the data points recorded by the oscilloscope.

Press the 'MEASURE' button for Automatic Test.

There are three auto measurement types: Voltage Measure, Time Measure, and Delay Measure. There are a total of 32 measurement parameters.

Table 3.37 – Auto Measurement Menu

Option	Description
Voltage	Press this button to enter the Voltage measure menu.

Time	Press this button to enter the Time measure menu.
Delay	Press this button to enter the Delay measure menu.
All Mea	Press this button to enter the All Measurement menu.
Return	Press this option button to return to the home page of the auto measure menu.

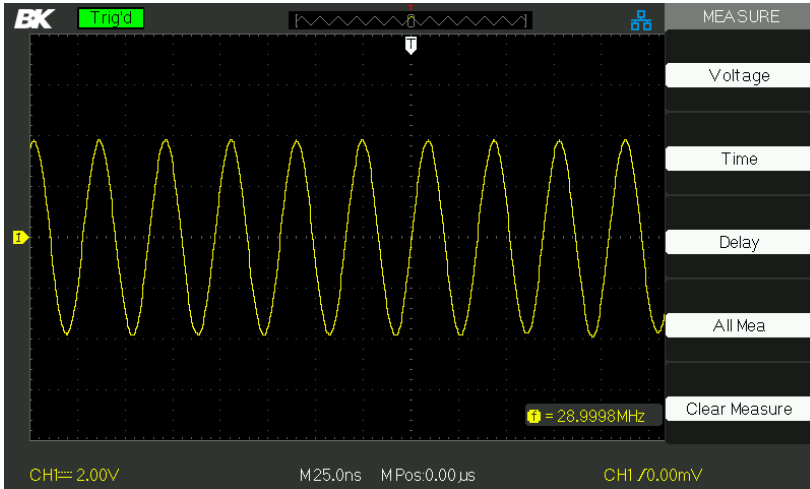

Figure 3.40 – Auto Measure Menu

Table 3.38 – Auto Voltage Measurement Menu

Option	Setting	Description
Source	CH1, CH2	Select input signal source for Voltage measure.
Type	Vpp, Vmax, Vmin, Vpp, Vamp, Vtop, Vbase, Vavg, Mean, Vrms, Cycle Vrms, FOVShoot, FPRESshoot, ROVShoot, RPRESshoot	Press the “Type” button or turn the “Universal” knob to select Voltage measure parameter.

		<p>Display the corresponding icon and measure value of your selected Voltage measure parameter.</p>
Return		<p>Return to the first page of auto measurement menu.</p>

Table 3.39 – Auto Time Measurement Menu

Option	Setting	Description
Source	CH1, CH2	<p>Select input signal source for Time measure.</p>
Type	Period, Freq, +Width, -Width, Rise Time, Fall Time, BWidth, +Duty, -Duty	<p>Press the “Type” button or turn the “Universal” knob to select Time measure parameter.</p>
		<p>Display the corresponding icon and measure value of your selected time measure parameter.</p>
Return		<p>Return to the first page of auto measurement menu.</p>

Table 3.40 – Auto Delay Measurement Menu

Option	Setting	Description
Source	CH1, CH2	Select any two input signal source for Delay measure.
Type	Phase, FRR, FRF, FFR, FFF, LRR, LRF, LFR, LFF	Press the “Type” button or turn the “Universal” knob to select Delay measure parameter.
		Display the corresponding icon and measure value of your selected Delay measure parameter.
Return		Return to the first page of auto measurement menu.

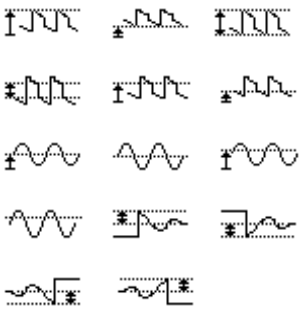
Table 3.41 – All Measurement Menu

Option	Setting	Description
Source	CH1 CH2	Select input signal channel.
Voltage	On Off	Turn on the all measurement function to measure voltage parameters. Turn of the all measurement function to measure voltage parameters.
Time	On Off	Turn on the all measurement function to measure Time parameters. Turn of the all measurement function to measure Time parameters.
Delay	On Off	Turn on the all measurement function to measure Delay parameters. Turn of the all measurement function to measure Delay parameters.

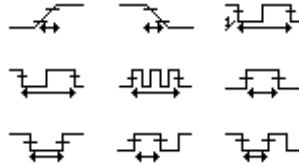









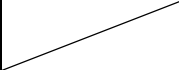



















Return		Return to the "All Measure main menu".
--------	---	--

Table 3.42 – Types of Measurements

Measure Type	Description
 Vmax	The most positive peak voltage measured over the entire waveform.
 Vmin	The most negative peak voltage measured over the entire waveform.
 Vpp	Measures the absolute difference between the maximum and minimum peaks of the entire waveform.
 Vtop	Measures the highest voltage over the entire waveform.
 Vbase	Measures the lowest voltage over the entire waveform.
 Vamp	Voltage between Vhig and Vlow of a waveform.
 Vavg	The arithmetic mean over the first cycle in the waveform.
 Mean	The arithmetic mean over the entire waveform.
 Crms	The true Root Mean Square voltage over the first cycle in the waveform.
 Vrms	The true Root Mean Square voltage over the entire waveform.
 ROVShoot	Defined as $(V_{max}-V_{hig})/V_{amp}$ after the waveform rising.
 FOVShoot	Defined as $(V_{min}-V_{low})/V_{amp}$ after the waveform falling.
 Vshoot	Defined as $(V_{min}-V_{low})/V_{amp}$ before the waveform rising.

RPREshoot	
 FPREshoot	Defined as $(V_{max}-V_{hig})/V_{amp}$ before the waveform falling.
 Rise Time	Measures the time between 10% and 90% of the first rising edge of the waveform.
 Fall Time	Measures the time between 90% and 10% of the first falling edge of the waveform.
 BWid	The duration of a burst. Measured over the entire waveform.
 + Wid	+ Width Measures the time between the first rising edge and the next falling edge at the waveform 50% level.
 - Wid	-Width Measures the time between the first falling edge and the next rising edge at the waveform 50% level.
 + Duty	Measures the first cycle waveform. Positive Duty Cycle is the ratio between positive pulse width and period.
 - Duty	Measures the first cycle waveform. Negative Duty Cycle is the ratio between negative pulse width and period.
 Phase	The amount one waveform leads or lags another in time. Expressed in degrees, where 360 degrees comprise one waveform cycle.
 FRR	The time between the first rising edge of source X and the first rising edge of source Y.
 FRF	The time between the first rising edge of source X and the first falling edge of source Y.
 FFR	The time between the first falling edge of source X and the first rising edge of source Y.

 FFF	The time between the first falling edge of source X and the first falling edge of source Y.
 LRR	The time between the first rising edge of source 1 and the last rising edge of source 2.
 LRF	The time between the first rising edge of source X and the last falling edge of source Y.
 LFR	The time between the first falling edge of source X and the last rising edge of source Y.
 LFF	The time between the first falling edge of source X and the last falling edge of source Y.

If you want to measure voltage parameters, please follow the steps below:

1. Press the “MEASURE” button to enter the “Auto measurement” menu.
2. Press the first option button to enter the “second measurement menu”.
3. Select measure type. If you press the “Voltage” option button, “Voltage measurement” menu will display on the screen.
4. Press the “Source” option button to select “CH1”, “CH2” according to input signal channel.
5. Press the “Type” option button to select the parameter type that you want to measure. The corresponding icon and value will display below the measure parameter.

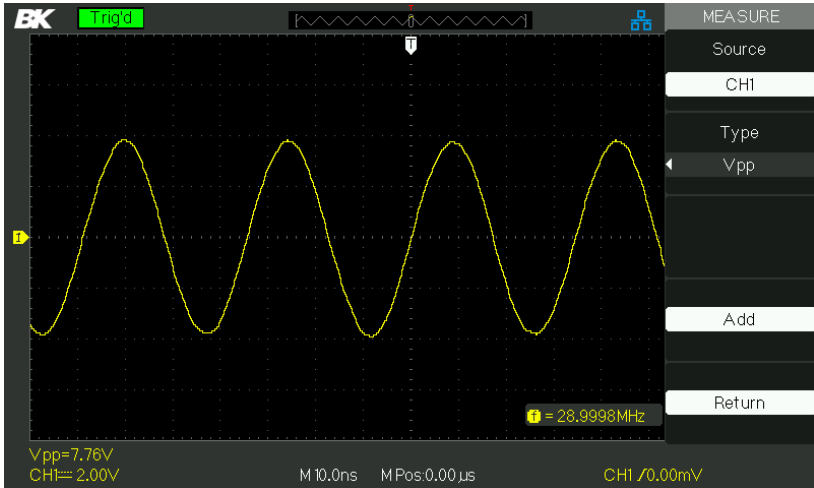

Figure 3.41 – Measuring Vpp Parameters

6. Press the “Return” option button to return to the home page of “Auto Measurement” menu. The selected parameter and the corresponding value will display on the top position of the home page.
You can display the other parameters and their value on the corresponding position in the same way. The screen can display five parameters at one time.

If you want to measure time parameters using all measure function, please follow these steps:

1. Press the “MEASURE” button to enter the “Auto Measure menu”.
2. Press the top option button to enter the second page of “Auto Measure menu”.
3. Press “All Mea” option button to enter the “All Measure menu”.
4. Press “Source” option button to select input signal channel.
5. Press the “Time” option button to select “On”. Now all of the time parameters value will display on the screen at the same time, as shown below.

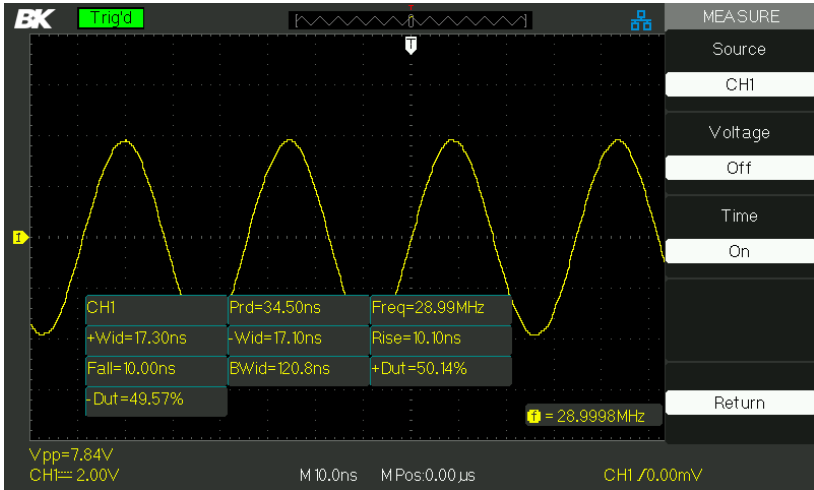

Figure 3.42 – Measuring All Time Parameters

3.15 Storage System

As shown below, the “SAVE/RECALL” button enters the “Storage System Function Menu”.

The oscilloscope can save and recall up to 20 instrument settings and 10 waveforms in internal memory. There is a USB Host interface on the front panel of the oscilloscope where you can save setup data, waveform data, waveform display image, and CSV file to a USB flash drive. Setup data and waveform data that are saved to a USB flash drive can be recalled on the oscilloscope. For picture data and CSV file, a computer must be used to view them.

- Using SAVE/RECALL Screen**
 The SAVE ALL screen is divided into functions based on Directory or Files.
 Directory shows option buttons for **New Directory**, **Delete Folder**, and **Load**.

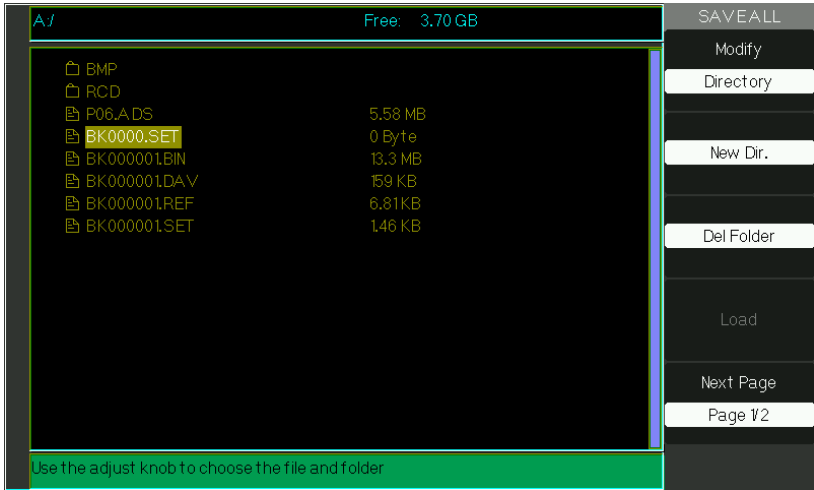

Figure 3.43 – Save All Menu (Directory)

While file shows option buttons for **New File**, **Delete File**, and **Load**.

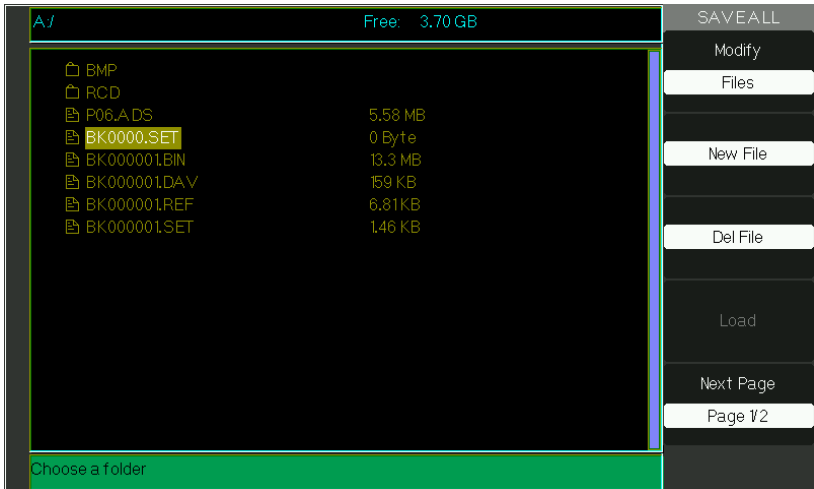

Figure 3.44 – Save All Menu (Files)

Recalling Files

The Load button is used to recall your setup files. Once you've navigated to the desired file and it's highlighted in the main screen area, press the Load option button and the setup is recalled from the USB flash drive.

NOTE: The Load button option is disabled (grayed-out) when .BMP or .CSV file types are selected.

Both Directory and Files have Rename and Return option buttons on Page 2/2. Use these buttons to give an existing folder or file a new name or to exit the SAVE ALL screen, respectively.

Creating Folders and Files

Create new folders and files by pressing the New Dir or New File option button. The following screen is shown:

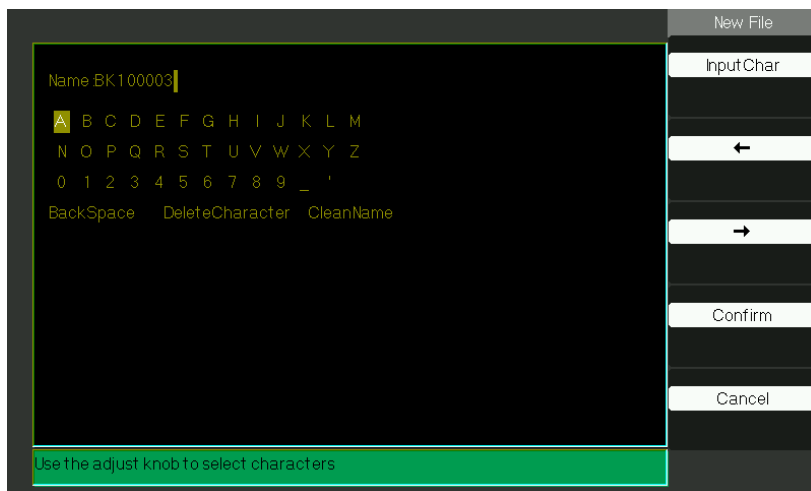

Figure 3.45 – Rename Menu

- The New File menu options are the same as the New Folder menu. The InputChar option button adds the selected character to the cursor position in Name field.
- Move the cursor position in the name field using the “→” and “←” option buttons.
- Turn the Universal knob to move through character selections. When the desired character is highlighted, press the Universal knob or press the “InputChar” option button to add it to the specific position in the Name field.
- Additional selections for BackSpace, DeleteCharacter, and CleanName are available for convenience and are also accessed using the “Universal” knob in the same manner.
- Press the “Confirm” option button (when you have the Name field completed as desired) to save the file onto the memory device. After the “Confirm” option button is pressed, a “Data Store Success!” messages briefly shown and the new folder or file is shown on your USB flash drive.

Save/Recall Setup

Save Setups to Device:

The complete setup is stored in nonvolatile memory. When you recall the setup, the oscilloscope will be in the mode from which the setup was saved. The oscilloscope saves the current setup if you wait three seconds after the last change before you power off the oscilloscope. The oscilloscope recalls this setup the next time you apply power.

Table 3.43 – Save Setup to Device Menu

Option	Setting	Description
Type	Setups	Menu for the Storage/Recall setting in the oscilloscope
Save to	Device	Save setup to the oscilloscope’s internal memory.

Setup	No.1 to No.20	Press the “Setup” option button or turn the “universal” knob to select storage position.
Save		Save to the selected storage location.
Recall		Recall from the storage location indicated by “Setup”.

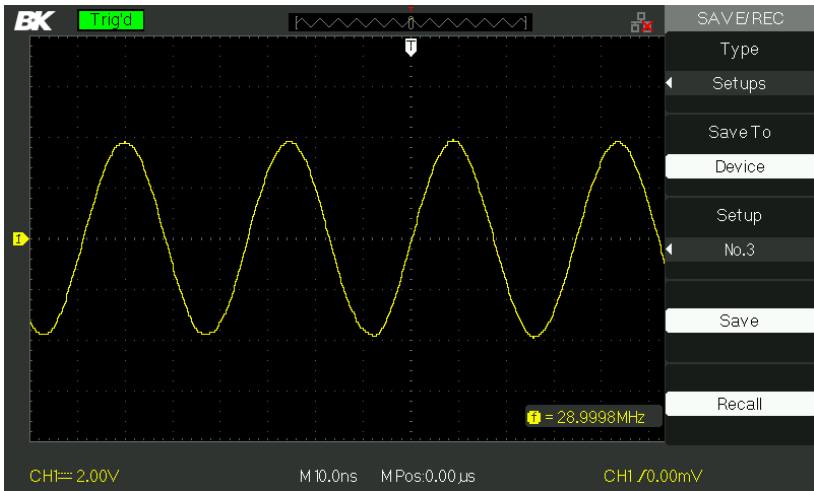

Figure 3.46 – Save/Rec Menu

To save setups to the oscilloscope’s internal memory, follow the steps below:

For example: Save setup that set waveform display type to “Dots” to internal memory.

1. Press the “SAVE/RECALL” button to enter the “SAVE/RECALL” menu.
2. Press the “Type” option button to select “setups”.
3. Press the “Save to” option button to select “Device”.
4. Press the “Setup” option button to select “No.1”.
5. Press the “DISPLAY” button to enter the “Display” menu.

6. Press the “Type” option button to select “Dots”.
7. Press the “SAVE/RECALL” button to enter the “SAVE/RECALL” menu.
8. Press the “Save” option button.

To recall setup, follow steps below:

1. Press the “SAVE/RECALL” button to enter the “SAVE/RECALL” display menu.
2. Press the “Type” option button to select “Setups”.
3. Press the “Save to” option button to select “Device”.
4. Press the “Setup” option button or turn the “Universal” knob to select “No.1”.
5. Press the “Recall” option button.

Save Setup to USB flash drive:

Table 3.44 – Save Setup to USB Flash Menu

Option	Setting	Description
Type	Setups	Menu for the Storage/Recall settings.
Save to	File	Save setup data to USB flash drive.
Save		Go to the Save/Recall interface

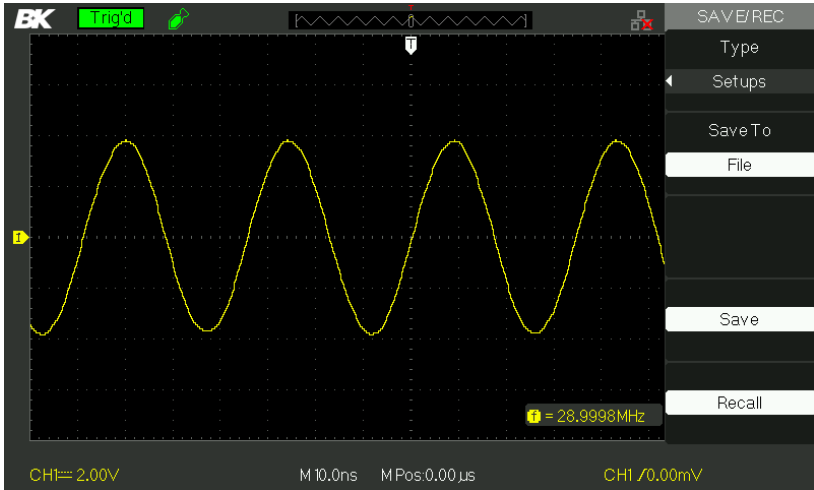

Figure 3.47 – Save Setup Menu

Save Setup to USB Flash drive:

For example: Save setup that set waveform display type to “Dots” to USB flash drive.

1. Press the “SAVE/RECALL” button to select “Setups”.
2. Insert USB flash drive to USB host port of the oscilloscope and wait that the oscilloscope has initialized USB flash drive (about five seconds).
3. Press the “Save to” option button to select “file”.
4. Press the “Save” option button then you’ll go into the Save/Recall interface.
5. Press the “New Dir.” button to create a new folder
6. Press the “Del folder” option button to delete a folder
7. Press the “New file” option button to create a new file
8. Press the “Del file” option button to delete a file
9. Press “the next page” option button and press the “Rename” option button to modify the name of the file or the folder.
10. Turn the “Universal” knob to select the folder and press the “Confirm” option button and you save the set to the USB drive.

To recall setup data from USB flash drive, follow the steps below:

1. Press the “SAVE/RECALL” button.
2. Press the “Type” button to select “Setups”.
3. Insert USB flash drive to USB host port of the oscilloscope and wait that the oscilloscope has initialized USB flash drive (about five seconds).
4. Press the “Save to” option button to select “File”.
5. Press the “Save” option button then you’ll go into the Save/Recall interface.
6. Choose the file you want then press the “Load” option button (within 5 seconds there will be a message “Read data success”). Now the setup data have been recalled from the USB flash drive.

Recall Factory

You can use this option to recall the factory settings

Table 3.45 – Factory Function Menu

Option	Setting	Description
Type	Factory	To view the Factory setup.
	Depth Recover	Clears all memory, including setups, waveforms and masks.
	Load	Recall the Factory setup.

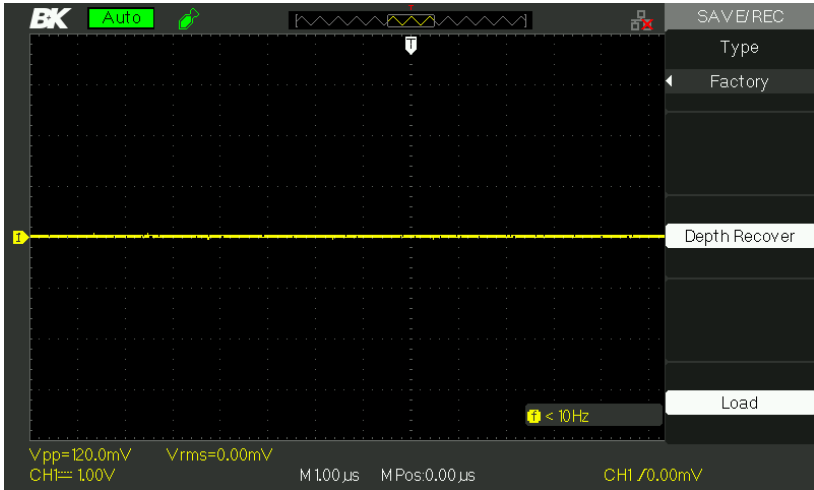

Figure 3.48 – Set Factory Default Settings

Save/Recall Waveform

Save Waveforms to Device

Table 3.46 – Save Waveform to Device Menu

Option	Setup	Description
Type	Waveforms	Selects Waveform for saving/recalling.
Save to	Device	Save waveforms to the oscilloscope’s internal memory.
Waveform	No.1 to No.10	Press the “waveform” option button or turn the “Universal” knob to select storage location.
Save		Save waveform to the selected storage location.
Recall		Recall the “Waveform” from the selected storage location in “Waveform” option.

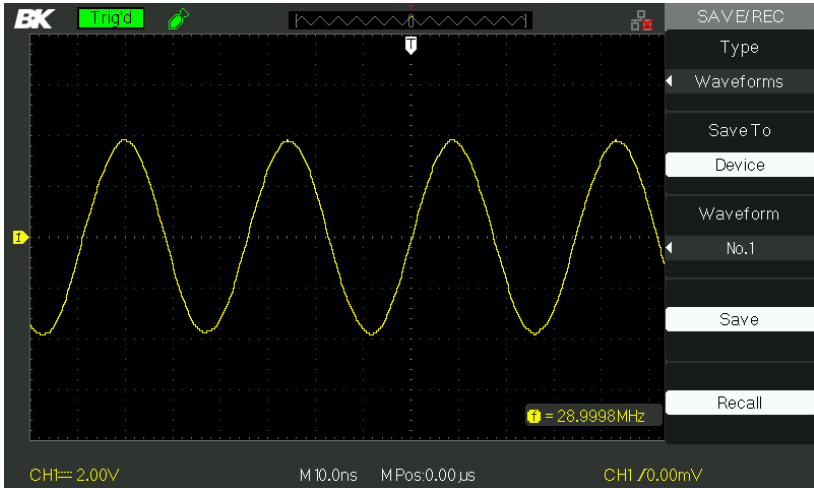

Figure 3.49 – Save Waveform Screen (To Internal Storage)

To save waveforms in internal memory, follow the steps below:

1. Input a sine signal to channel 1 and press the “Auto” button.
2. Press the “SAVE/RECALL” button to enter “SAVE/RECALL” display menu.
3. Press the “Type” option button to select “Waveforms”.
4. Press the “Save to” option button to select “Device”.
5. Press the “Waveform” option button or turn the “Universal” knob to select “No.1”.
6. Turn the “Volts/div” knob or “Time/div” knob to adjust the waveform that you want.
7. Press the “Save” option button.

To recall waveforms, follow the steps below:

1. Press the “SAVE/RECALL” button to enter “SAVE/RECALL” display menu.
2. Press the “Type” option button to select “Waveforms”.
3. Press the “Save to” option button to select “Device”.
4. Press the “Waveform” option button or turn the “Universal” knob to select “No.1”.
5. Press the “Recall” option button.

Save Waveforms to USB Flash Drive

Table 3.47 – Save Waveform to USB Flash Menu

Option	Setup	Description
Type	Waveforms	Menu for the Storage/Recall waveforms.
Save to	File	Select save location to USB flash drive.
Save		Select to save to USB.

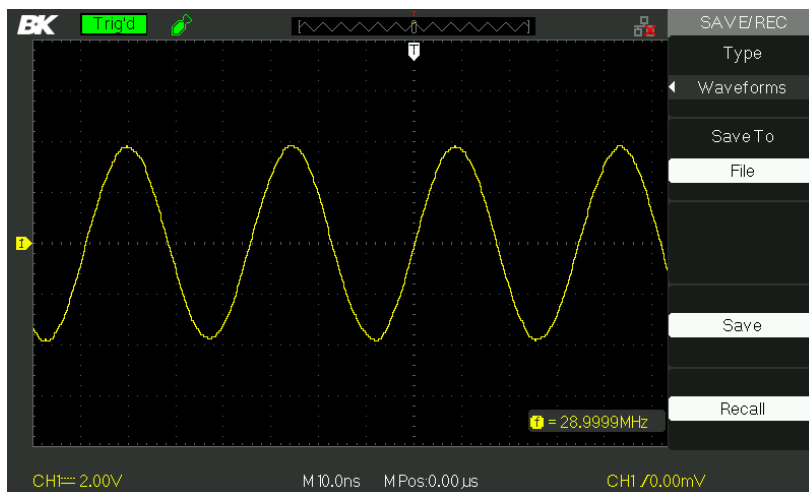

Figure 3.50– Save Waveform Screen (To Flash Drive)

To save waveforms to a USB flash drive, follow the steps below:

1. Input a sine signal to channel 1, press the “AUTO” button.
2. Press the “SAVE/RECALL” button to enter the “SAVE/RECALL” display menu.
3. Press the “Type” option button to select “Waveforms”.

4. Insert a USB flash drive to the front or rear USB host port of the oscilloscope and wait until the oscilloscope has initialized USB flash drive (about five seconds).
5. Press the “Save to” option button to select “File”.
6. Press the “Save” option button then you’ll go into the Save/Recall interface.
7. Create a file then press the “Confirm” button (about five seconds, there will be a message “Save data success” displayed on the screen). Now the waveform data have been saved to the USB flash drive.

Recall waveforms from USB flash drive, follow next steps:

1. Press the “SAVE/RECALL” button.
2. Press the “Type” button to select “Waveforms”.
3. Insert a USB flash drive to the front or rear USB host port of the oscilloscope and wait until the oscilloscope has initialized USB flash drive (within ten seconds).
4. Press the “Save to” option button to select “File”.
5. Press the “Save” option button then go into the Save/Recall interface.
6. Choose the file you want then press the “Load” option button (about five seconds, there be a message “Recall data success” displayed on the screen). Now the waveform data have been recalled from the USB flash drive.

Save Picture/Screenshot

The display screenshot can be saved to a USB flash drive, but they cannot be recalled. Images can be opened on a computer.

Table 3.48 – Picture Storage Menu

Option	Setting	Description
Type	Pictures	Select save screenshot.
Save		Saves screenshot to USB flash drive.

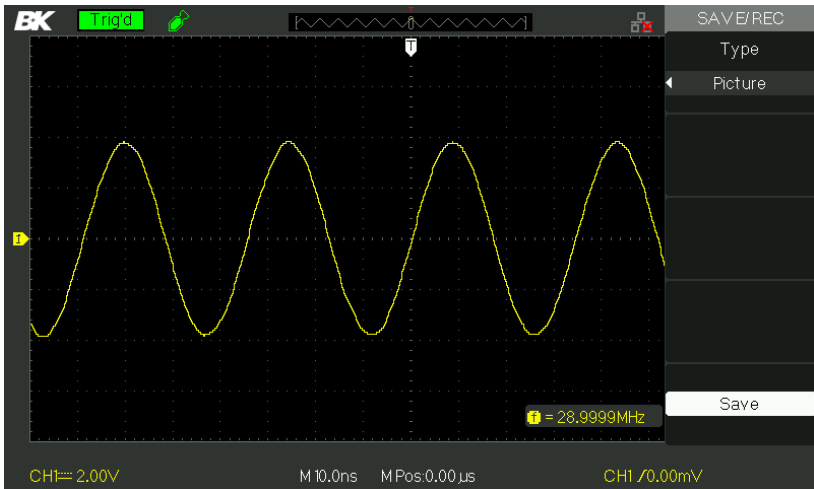

Figure 3.51 – Save Picture Screen

To save waveform images to USB flash drive, follow the steps below:

1. Select the screen image that you want.
2. Press the “SAVE/RECALL” button to enter “SAVE/RECALL” menu.
3. Press the “Type” option button to select “Picture”.
4. Insert a USB flash drive to the USB host port of the oscilloscope and wait until the oscilloscope has initialized the USB flash drive (about five seconds).
5. Press the “Print Key” option button to save the screenshot image to the USB flash drive.
6. Alternatively, you can customize the file name to save into by pressing the “Save” option.
7. The “SAVE ALL” menu will display. Select “New File” and enter the filename.
8. Press the “Confirm” button (within five seconds, there will be a message “Save data success” displayed on the

screen). Now the screenshot image has been saved to the USB flash drive.

Save/Recall CSV

Table 3.49 – CSV Storage Menu

Option	Setting	Description
Type	CSV	Menu for the Storage .CSV file to USB flash drive.
Data Depth	Displayed Maximum	Set to store displayed waveform data to .CSV file. Set to store maximum waveform data to .CSV file.
Para Save	On Off	Set whether to include waveform parameters in the .CSV file or not.
Save		Go to the SAVE ALL interface.

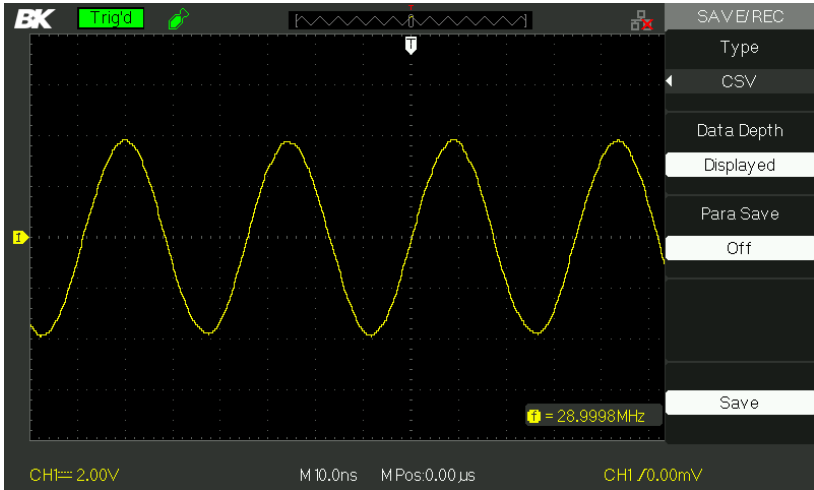

Figure 3.52 – Save to CSV Screen

To save CSV files to USB flash drive, follow the steps below:

1. Press the “SAVE/RECALL” button to enter “SAVE/RECALL” menu.
2. Press the “Type” option button to select “CSV”.
3. Insert USB flash drive to USB host port of the oscilloscope and wait that the oscilloscope has initialized USB flash drive (about five seconds).
4. Press the “Data Depth” option button to select “Displayed” or “Maximum”.
5. Press the “Para Save” option button to select “On” or “Off”.
6. Press the “Save” option button then you’ll go into the Save/Recall interface
7. Create a file name then press the “Confirm” button (within 5 seconds, there will be a message “Save data success” displayed on the screen). Now the CSV file has been saved to the USB flash drive.



NOTE: The maximum number of data points of a waveform that can be saved as a .CSV file into USB drive is ~40000 pts (depending on the time base setting) when data depth is set to maximum. The actual number depends on the time base setting, the channels that are active, and whether data depth is set to “display” or “maximum”. See below table for maximum data points available in each time base when data depth is set to maximum.

	Number of points saved to CSV file (data depth set to maximum)	
Time Base	Single Channel	Dual Channel
2.5 ns – 50 ns	40 k	20 k
100 ns – 50 ms	20 k	20 k

3.16 Utility System

Press the UTILITY button from the front panel to access utility options.

Table 3.50 – Utility System Menu 1

Option	Setting	Description
System Status		Displays summaries of the oscilloscope settings.
Sound	 	Turn on sound Turn off sound.
Counter	On Off	Turn on Frequency Counter Turn off Frequency Counter.
Language	简体中文 繁體中文 English العربية Français Deutsch Русский Español Português	Simplified Chinese Traditional Chinese English Arabic French German Russian Spanish Portuguese

	日本語 한국어 Italiana	Japanese Korean Italian
Next Page	Page 1/4	Press this button to enter second page.

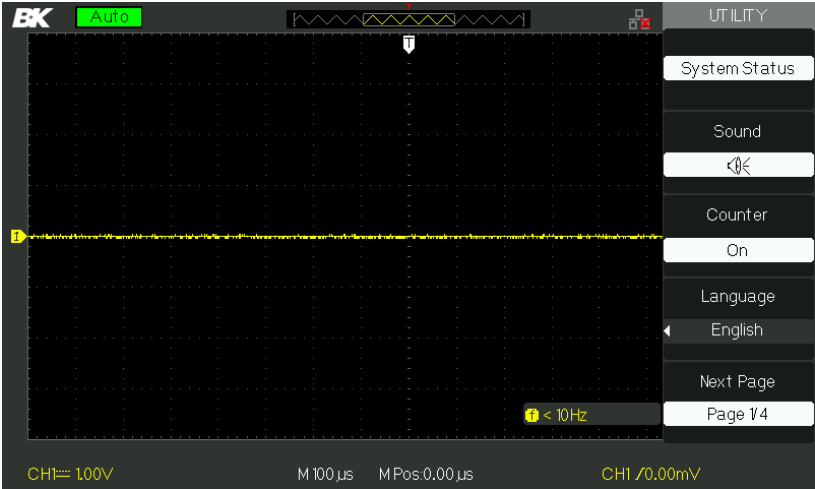

Figure 3.53 – Utility Menu Screen 1

Table 3.51 – Utility System Menu 2

Option	Setting	Description
Do Self Cal		Auto self emendation.
Do Self Test	Screen Test Keyboard Test LED Test	Run the screen test program Run the keyboard test program Run the LED test program.
Back USB	USBTMC	Configures the USB port to USBTMC interface. Use this

		for remote communication via SCPI.
Next Page	Page 2/4	Press this button to enter third page.

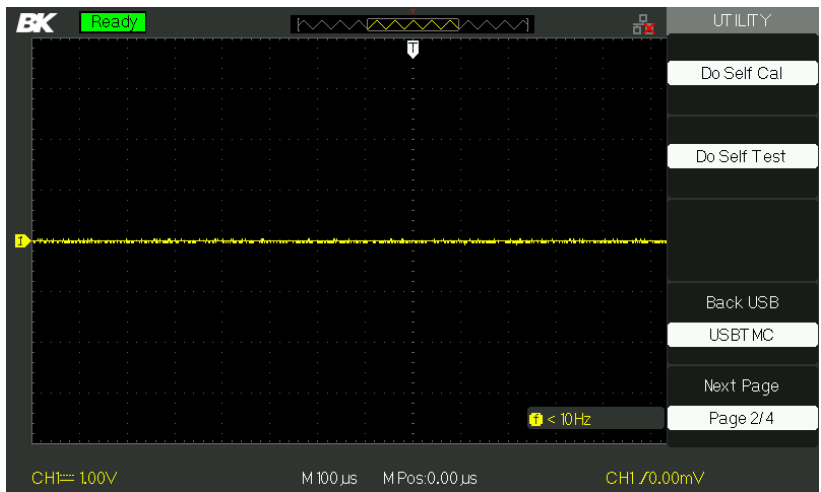

Figure 3.54 – Utility Menu Screen 2

Table 3.52 – Utility System Menu 3

Option	Setting	Description
Update firmware		Update the firmware of the oscilloscope using a USB flash Drive.
Pass/Fail		Press this button to enter the “Pass/Fail menu”.
Record		Press this button to enter the waveform record menu.
IO Setting		Press this button to set the LAN IP and GPIB settings. Use this for remote communication via SCPI.
Next Page	Page 3/4	Press this button to enter fourth page.

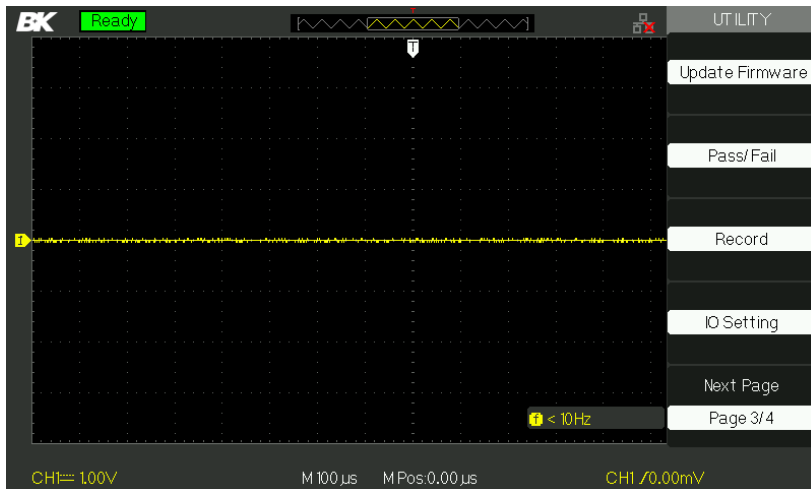

Figure 3.55 – Utility Menu Screen 3

Table 3.53 – Utility System Menu 4

Option	Setting	Description
Screen-saver	1min, 2min, 5min, 10min 15min, 30min, 1hour, 2hour, 5hour ,Off	Set the time of Screen-saver
Recorder		Enter recorder function (scan mode only)
Next Page		Press this button to enter first page.

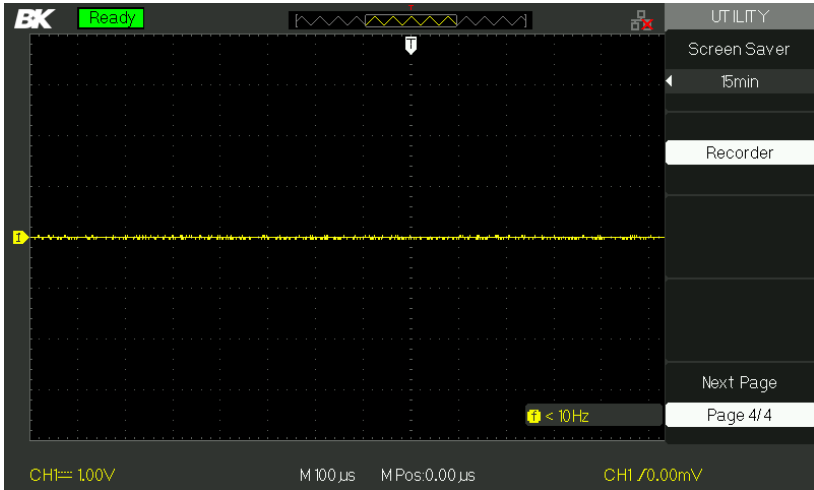

Figure 3.56 – Utility Menu Screen 4

System Status

Press the “System Status” option button of the Utility Menu to view the oscilloscope’s hardware and software configuration.



Figure 3.57 – System Status Screen

Table 3.54 – System Status Information

Option	Description
Startup Times	List the number of startup times.
Software version	List the software version.
Hardware Version	List the hardware version.
Product type	List the product model.
Serial No.	List the product serial number.

Language

Menu items can be displayed in 12 different languages, selectable by the user.

Press the “UTILITY” button and then select “Language”.

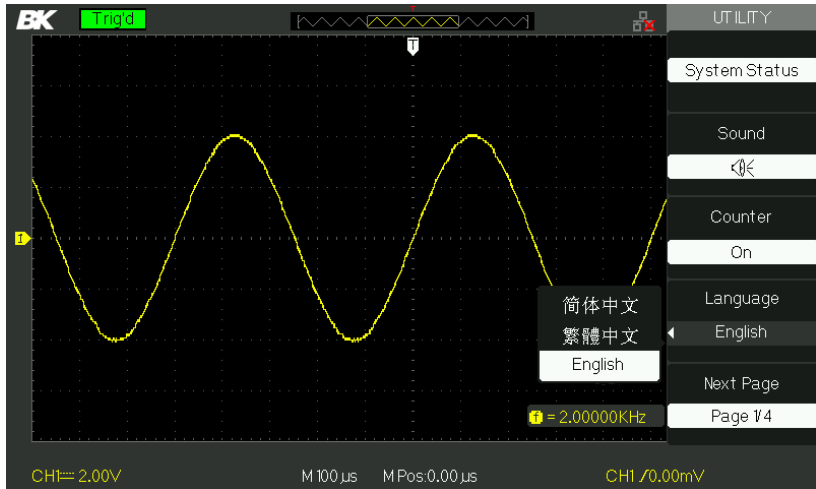

Figure 3.58 – Language Selection Screen

Self Calibration

Self Calibration procedure can optimize the signal path for optimal measurement results. You can run this procedure at any time. If the operating temperature changes by more than 5° C or the instrument runs more than thirty minutes, running self calibration is recommended.

When you run the self Calibration, you must disconnect all the probes and leads, and make sure the scope is not in Single-Shot mode. Then press the “Utility” button to choose the “Do self cal” to show the self Calibration Menu, and execute self calibration program according to the prompt on the screen.

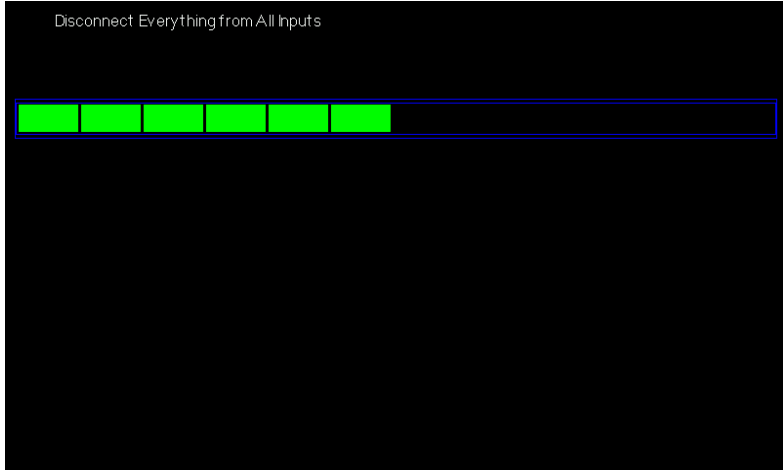

Figure 3.59 – Self Calibration Screen

Self Test

Press “UTILITY” and select “Do Self Test”

Table 3.55 – Self Test Menu 1

Option	Description
Screen Test	Run Screen Test Program.
Keyboard Test	Run Keyboard Test Program.
LED Test	Run LED Test Program.

Screen Test

Select “Screen Test” to enter the screen test interface. The message “Press ‘SINGLE’ Key to continue, Press ‘RUN/STOP’ Key to exit” is displayed. Press “Single” button to run through the screen color test, or press “Run/Stop” to exit.

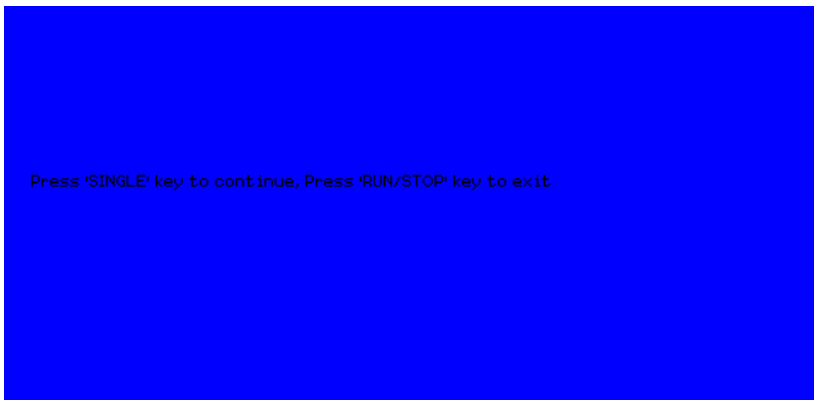

Figure 3.60 – Screen Test Start Screen

Keyboard Test

Select “Keyboard Test” to enter the key test interface. The on-screen shapes represent the front panel keys. The shapes with two arrows beside them represent the front panel knobs. The squares represent the knob presses for scale knobs. Test all keys and knobs to verify that all the backlit buttons illuminate correctly.

NOTE: When you first enter the test, the screen will display all on-screen shapes in white color.

Pressing any buttons on the front panel will cause its corresponding shape on the display to turn green if it is functioning normally.

To exit the test at any time, Press ‘ RUN/STOP’ key three times to exit as indicated at the bottom of the screen.

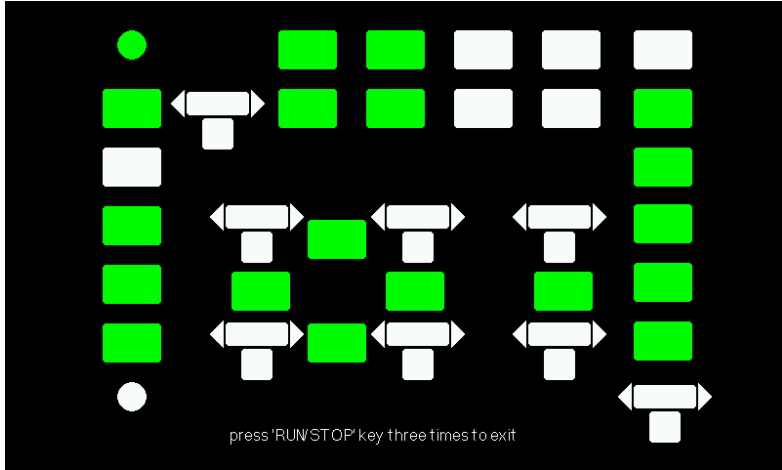

Figure 3.61 – Key Test Screen

LED Test

Select “LED Test” to test the LED backlights on some of the front panel buttons. The screen will display key shapes that represent all the buttons of the front panel. Follow the instruction prompt below and “Press ‘SINGLE’ Key to continue. Press ‘RUN/STOP’ Key to exit”. Each time “SINGLE” key is pressed, a key shape on the screen will turn green, indicating that the corresponding key or indicator should be lit up. Press “SINGLE” again to test another key backlight. Once all the individual backlit keys are tested, all of them will turn on simultaneously. Pressing “SINGLE” key again will restart all over. To Exit the test, press “RUN/STOP” key.

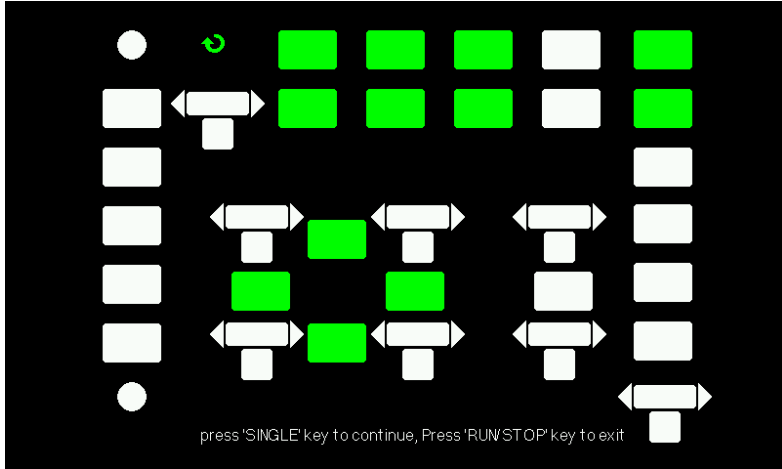

Figure 3.62 – LED Test Screen

Update Firmware

The firmware of the oscilloscope can be updated directly via a USB Flash drive. This process takes about two minutes. To update, follow the steps below:

1. Download and save the firmware file onto a USB flash drive.
2. Insert the USB Flash Drive to the USB Host interface on the front panel of the oscilloscope.
3. Press the “UTILITY” button to enter the “Utility menu”.
4. Press the “Next Page” option button to enter the third page of the “Utility menu”.
5. Press the “Update Firmware” option button. Read the on-screen notes carefully before proceeding.
6. Press the “SINGLE” button to enter into the directory menu of the USB flash drive.
7. Use the universal knob to select the firmware file on the USB flash drive, and select “Confirm” to start the update.

8. When completed, turn off the oscilloscope and turn on again. The software will then be updated. The oscilloscope will require self calibration after the update. Go into the utility menu's second page and select "Do Self Cal" to run self calibration.

WARNING: Do NOT turn off the power while the oscilloscope is updating. Otherwise, the firmware will be corrupted, and the instrument may not be able to reboot again.

Pass/Fail

The Pass/Fail function can monitor changes of signals and output pass or fail signals by monitoring the input signal and checking if it is within the predefined mask or not.

Table 3.56 – Pass/Fail Menu 1

Option	Setting	Description
Enable	On Off	Turn on Pass/Fail function. Turn off Pass/Fail function.
Source	CH1 CH2	Select signal input channel.
Operate	▶ ■	Press to run the Pass/Fail test. Press to stop the Pass/Fail test.
Msg Display	On Off	Turn on times display information of the waveform pass/fail. Turn off times display information of the waveform pass/fail.
Next Page	Page 1/2	Press this button to enter second page of Pass/Fail menu.

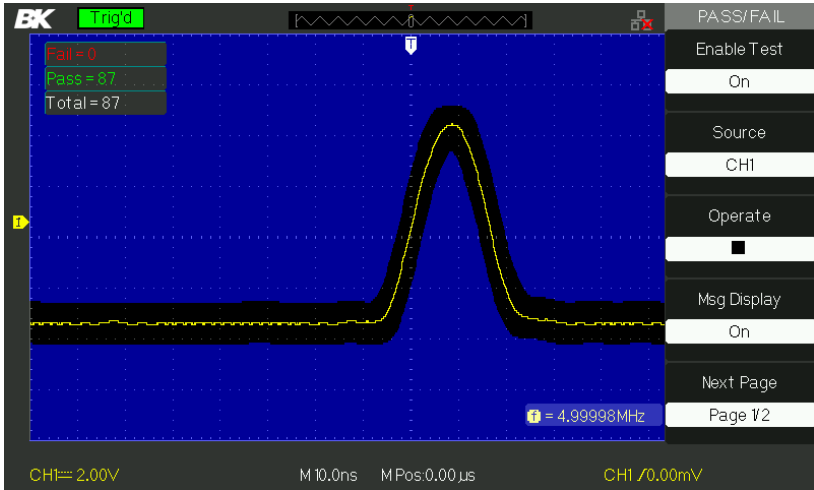

Figure 3.63 – Pass/Fail Screen 1

Table 3.57 – Pass/Fail Menu 2

Option	Setting	Description
Output	Pass Fail	Output signal when pass condition is detected. Output signal when fail condition is detected.
Stop On Output	On Off	When On, stops test when output occurs. When Off, continues test when output occurs.
Mask Setting		Enter the "Mask Setting menu".
Return		Return to the Pass/Fail main menu.
Next Page	Page 2/2	Return to the first page of Pass/Fail menu.

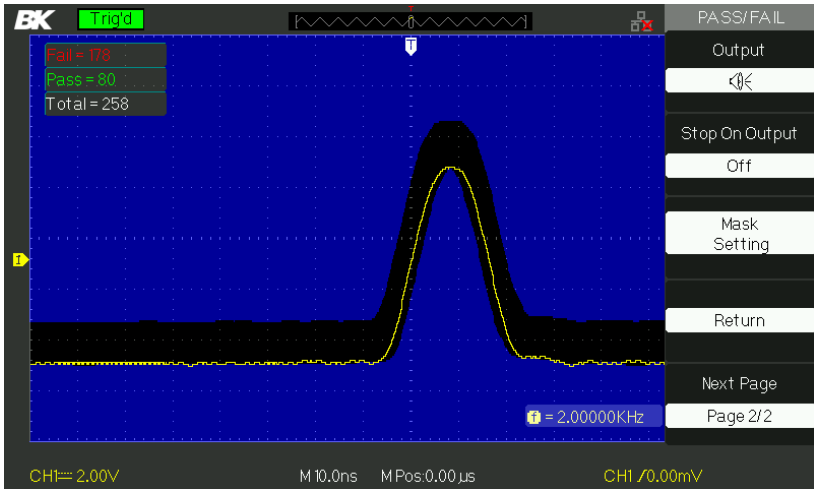

Figure 3.64 – Pass/Fail Screen 2

Table 3.58 – Mask Settings Menu 1

Option	Setting	Description
X Mask ↻ xdiv		Turn the “Universal” knob to set the range of horizontal clearance to the waveform. <0.04div-4.00div>
Y Mask ↻ ydiv		Turn the “Universal” knob to set the range of vertical clearance to the waveform. <0.04div-4.00div>
Create Mask		Create a test mask according to the above clearance.
Location	Internal External	Select position to store created mask.
Next Page	Page 1/2	Enter the second page of “Mask Setting menu”.

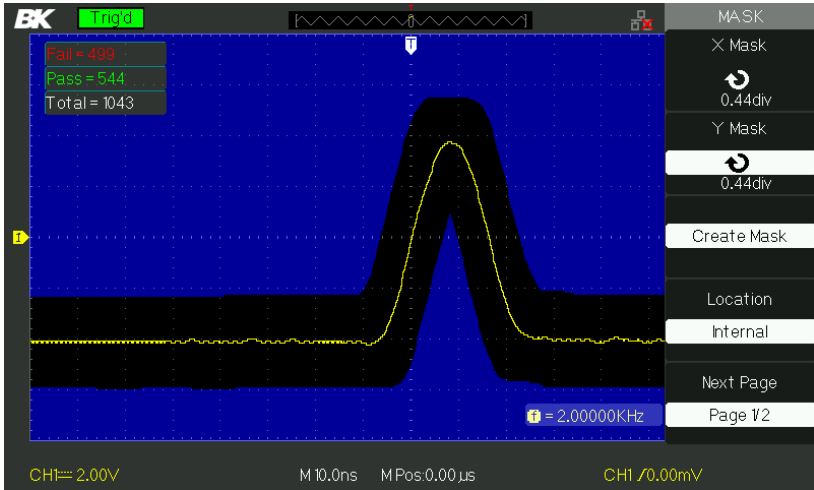

Figure 3.65 – Mask Menu Screen 1

Table 3.59 – Mask Settings Menu 2

Option	Setting	Description
Save		Store created mask setting.
Load		Recall stored mask setting.
Return		Return to the main menu of mask setting.
Last Page	Page 2/2	Return to the first page of “Mask Setting menu”.

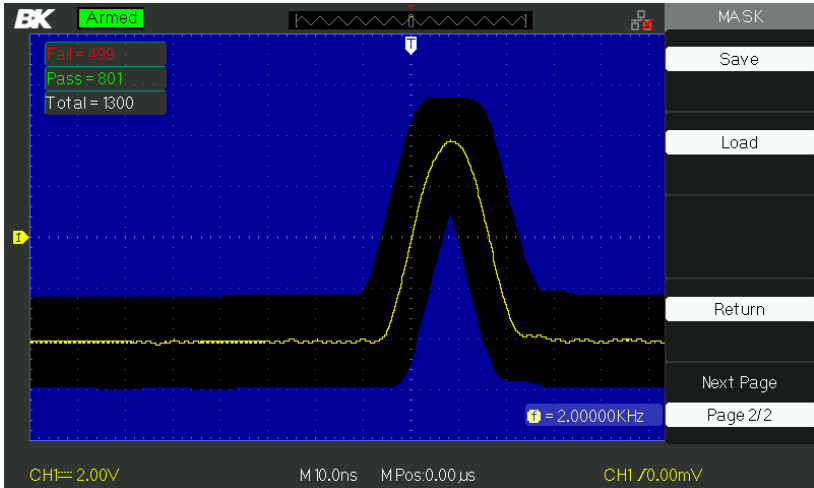

Figure 3.66 – Mask Menu Screen 2

RUN Pass/Fail test, please follow next page:

1. Press UTILITY button to enter the “Utility menu”.
2. Press the “Next Page – Page 1/4” option button.
3. Press the “Next Page – Page 2/4” option button to enter the third page of “Utility menu”
4. Press the “Pass/Fail” option button to enter the “Pass/Fail” function menu.
5. Press the “Enable Test” option button to select “On”.
6. Press the “Source” option button to select input signal channel.
7. Press the “Next Page – Page 1/2” option button to enter the second page of the “Pass/Fail menu”.
8. Press the “Mask Setting” option button to enter the first page of “Mask menu”.
9. Press the “X Mask” button; turn the “Universal” knob to adjust the horizontal clearance.
10. Press the “Y Mask” button; turn the “Universal” knob to adjust the vertical clearance.
11. Press the “Create Mask” button to create mask and you also can enter the next page of “Mask menu” to recall the stored mask.





12. Enter the second page of “Pass/Fail function menu”, press the “Output” option button to set the output option.
13. Enter the first page of “Pass/Fail function menu”, press the “Operate” option button to select “▶” to run the pass/fail test.

Waveform Record

Record

Press the Record option to record the input waveform from CH1 or CH2 with a maximum record length of 2500 frames. The time between frames is adjustable. You can record Pass/Fail test output (especially useful when capturing abnormal signals over a long period of time) without having to watch the signal.

Table 3.60 – Waveform Record Function Menu

Option	Setting	Description
Mode	Record	Set Record function menu.
	Play Back	Set Play Back function menu.
	Storage	Set Storage function menu.
	Off	Turn off waveform recorder menu.
Source	CH1 CH2 P/F-OUT	Select record source channel.
Interval		Set time interval between record frames.
End Frame		Set max number of record frames.
Operate	 (Record)	Press to start recording.
	 (Stop)	Press to stop recording.

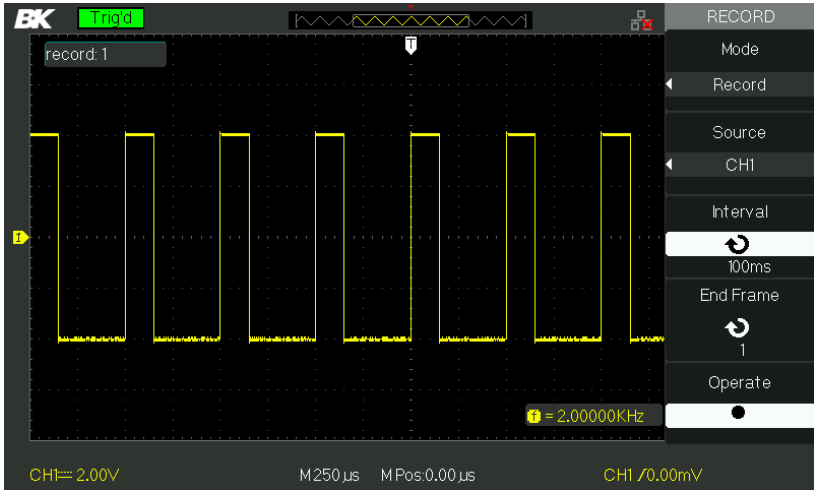

Figure 3.67 – Record Menu Screen (Record Mode)

To record waveforms, follow these steps:

1. Press the UTILITY button to enter “Utility menu”.
2. Press the “Next Page” option button to enter the third page of “Utility menu”.
3. Press the “Record” button to enter “Waveform Record Menu”.
4. Press the “Mode” option button to select “Record”.
5. Press the “Source” option button to select the input signal channel.
6. Select “Interval” option and turn the “Universal” knob to adjust time interval between record frames.
7. Select “End Frame” and turn the “Universal” knob to adjust the max record frame.
8. Press “●” in “Operate” option to record waveform.

Play Back

Play back current recorded waveforms or recorded waveforms that have been saved.

Table 3.61 – Waveform Playback Function Menu 1

Option	Setting	Description
Mode	Play Back	Set the Play Back function menu.
Operate	▶ (Run) ■ (Stop)	Press to start playback playing. Press to stop playing.
Play Mode	↻ ▶→■	Set circular play mode. Set single time play mode.
Interval	↻	Set time interval between frames.
Next Page	Page 1/2	Enter the second page of Play Back menu.

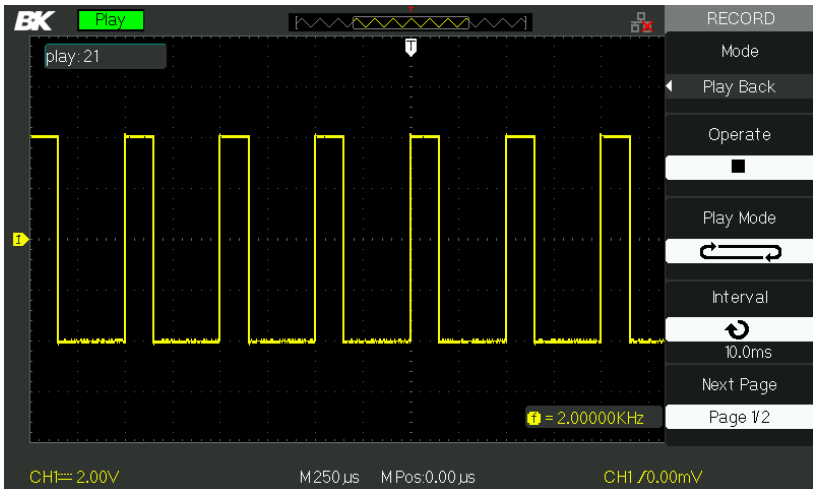



Figure 3.68 – Playback Menu Screen 1 (Recode Mode)

Table 3.62 – Waveform Playback Function Menu 2

Option	Setting	Description
Start Frame	↻	Set start frame.
Curr_Frame	↻	Select current frame to be played.

End Frame		Set End frame.
Return		Press to return to the waveform recorder main menu.
Next Page	Page 2/2	Return to the first page of Play Back function menu.

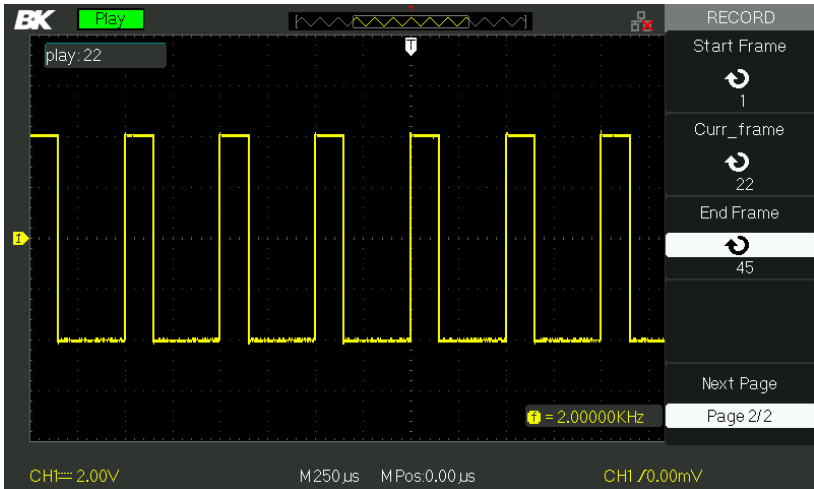



Figure 3.69 – Playback Menu Screen 2 (Recode Mode)

To play back current record waveforms, follow these steps:

1. Press UTILITY button to enter “Utility menu”.
2. Press the “Mode” option button to select “Play Back”.
3. Press the “Play Mode” option button to select “ ” or “ ”.
4. Press the “Interval” option button to select time interval between play back frames.
5. Press the “Next Page - Page 1/2” to enter the second page of “Play Back function menu”.
6. Select the “Start Frame” option, turn the “Universal” knob to adjust the start frame of play back waveform.

7. Select the “End Frame” option, turn the “Universal” knob to adjust the end frame of play back waveform.
8. Press the “Next Page - Page 2/2” option button to return to the first page of “Play Back menu”.
9. Press the “▶” option button in “Operate” option to play back waveforms.

Recorder (Scan Mode Only)

This mode allows for gap-free recording of waveform data and can be enabled in SCAN MODE only (refer to “Horizontal Control Knob section”). It is similar to the above described waveform recorder mode, however the recorded data can be played back on-screen and be retrieved from storage memory. Maximum recordable data depends on the time base in scan mode. Recorded data can also be stored into external USB flash drive.

Table 3.63 – Waveform Recorder Function Menu

Option	Description
Record	Record the waveform persistently
Replay	Replay recorded waveform
Option	Set the recorder properly
Return	Quit the recording function

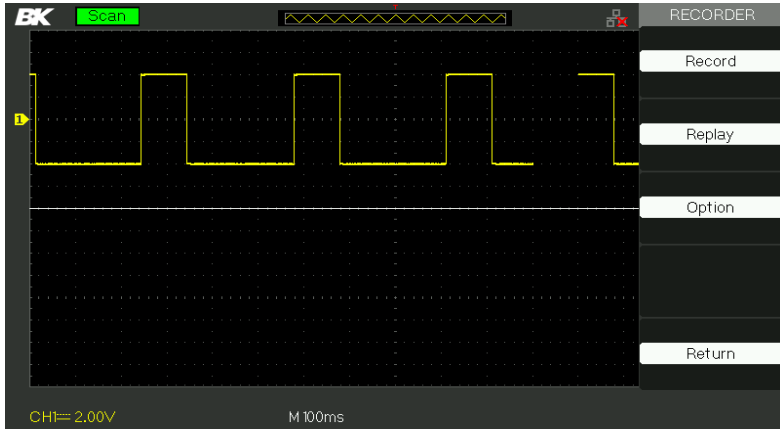

Figure 3.70 – Recorder Screen

Table 3.64 – Waveform Recorder (Record Mode) Menu

Option	Setting	Description
Start		Start the recording
Replay		Replay the recorded waveform.
Copy		When Store Mode is set to USB key, this will show the filename
Store Mode	Memory USB key	Stores recording to internal memory. Stores recording to external USB flash drive.
Return		Return to the Recorder Menu.

Table 3.65 – Waveform Recorder (Replay Mode) Menu

Option	Description
Continue/Pause	Continue/Pause when playing back a waveform recording.
Restart	Restart the playback of the recorded waveform
Previous	Recall the waveform recording.

Next	Fast forward play the recalled waveform recording.
Return	Return to the Recorder Menu

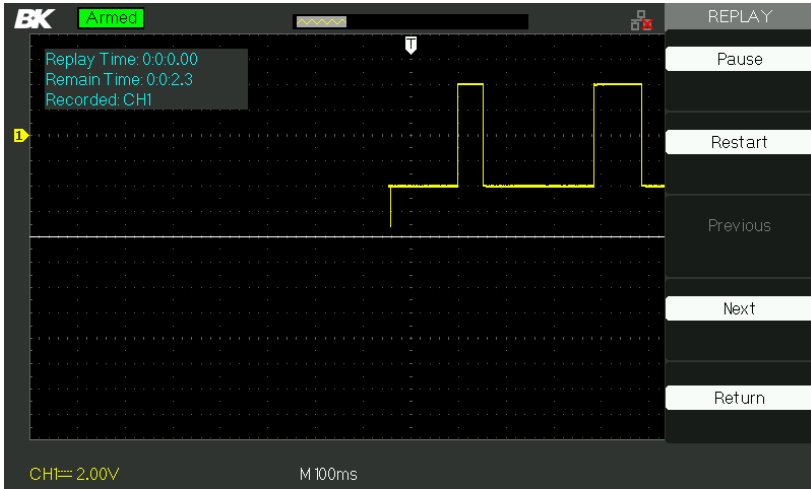

Figure 3.71 – Replay Screen

Table 3.66 – Waveform Recorder Option Menu

Option	Setting	Description
Viewer	Full Screen	Waveform of Full screen recording and channel recalling
	Split	Waveform of recording on split screen and channel recalling, CH1 is displayed in upper half-screen, and CH2 is displayed in lower half-screen.
Record Mode	Roll	Recorder saves the channel waveform persistently; the latter waveform will cover the former.
	Single	Recorder will stop waveform saving when its memory is full.

Replay Mode	By point	When recalling, the screen waveform refresh from left to right
	By frame	When recalling, screen waveform will refresh completely according to the capturing time of each frame
Return		Exit the Recorder Setting Menu.

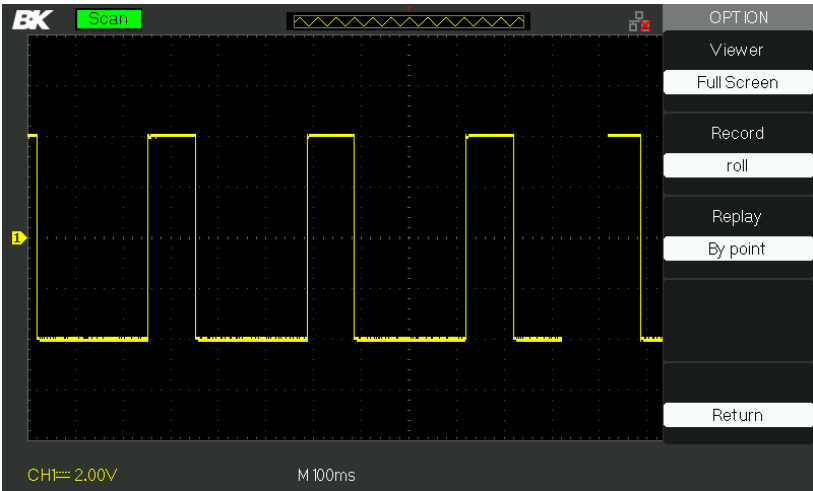

Figure 3.72 - Recorder Option Screen

Recorder Operation step:

1. Press the UTILITY button to enter “Utility” menu.
2. Press the “Next Page” option button to enter the fourth page of “Utility” menu.
3. Press the “Recorder” button to enter the Recorder menu.
4. Press the “Option” button to set Recorder options.
5. Press the “Record” button to enter the Record menu and then press “Start” button to start recording waveform
6. After completely recording waveform, press the “Replay” button to view the recorded waveform.

LAN Configuration

Do the following steps to set the oscilloscope to communicate with PC via LAN:

1. Connect the oscilloscope to your local area network using the network cable.
2. Press the **Utility** button on the front panel to enter the UTILITY function menu.
3. Press the **I/O Set** softkey to enter the I/O SET function menu.
4. Press the **LAN** softkey to enter the LAN setting interface, see the picture below:



Figure 3.73 – LAN Configuration

Note: To move to the right, press **the Universal Button**. To change the values of the menus rotate the **Universal Button** and finally to jump to the next line press the button below the Menu On/Off button (top right corner of the screen).

5. Press the button below the Menu On/Off button (top right corner of the screen) continually to go to the DHCP line; then turn the **Universal Knob** to select Enable or Disable (it also works to change the numbers on the rest of options)

- **Enable:** the DHCP server in the current network will assign the network parameters (such as the IP address) for the oscilloscope.
 - **Disable:** you can set the IP address, subnet mask, gate way manually.
 - Turn the **Universal Knob** to select the desired value.
 - Push the **Universal Knob** to change item horizontally.
 - Press the button below the Menu On/Off button (top right corner of the screen) to go to the next line.
 - Press the **Save/Recall** softkey to save the current setting.
 - Press the **Single** button to exit the setting interface.
6. Use EasyScopeX or NI Visa to communicate with the oscilloscope.

Help Menu

The oscilloscope has a help menu to assist users with operating the oscilloscope. Press the “HELP” button to enter the help status and then press any button to recall the corresponding help information. All submenus of every main menu have their help information.

NOTE: If you want to see help information of the next page submenus, first press the “HELP” button to exit the help status. Then switch to the next page menu and press the “HELP” button again to enter the help function.

Education Mode

The 2190E provides an EDU Mode that will allow users to disable the Auto, Measure, and Cursors buttons. These buttons automatically set up the scope to display a signal and calculate measurements, circumventing the need to know how to set up scope parameters. Disabling these features can be used by educators for teaching waveform measurement fundamentals as if it was an analog oscilloscope.

To receive information on how to access EDU Mode, please contact B&K Precision at <http://www.bkprecision.com/contact-us.html>.

4 Application Examples

This section presents a series of application examples. These simple examples highlight the features of the oscilloscope and give ideas for using it to solve your own test problems.

- Taking simple measurements
- Taking cursor measurements
- Capturing a single-shot signal
- Analyzing signal detail
- Triggering on a video signal
- Application of X-Y function
- Analyzing a differential communication signal using math functions

4.1 Taking Simple Measurements

Observe an unknown signal in a circuit, display the signal quickly and measure the frequency and peak-to-peak amplitude.

- **Using Auto set**

To quickly display a signal, follow these steps:

1. Press the CH1 button, set the Probe option attenuation to 10X and set the switch to 10X on the probe.
2. Connect the channel 1 probe to the signal.
3. Press the AUTO button.
4. The oscilloscope sets vertical, horizontal, and trigger controls automatically. If you want to optimize the display of the waveform, you can adjust these controls manually.

NOTE: The oscilloscope displays relevant automatic measurements in the waveform area of the screen based on the signal type detected.

- **Taking Automatic Measurements**

The oscilloscope can take automatic measurements of most displayed signals. To measure signal frequency and peak-to-peak amplitude, follow these steps:

Measure signal frequency

1. Input the signal to channel 1.
2. Press the "AUTO" button.
3. Press the "MEASURE" button to see "Auto Measure Menu".
4. Press the top option button.
5. Press the "Time" option button to enter the "Time Measure menu".
6. Press the "Source" option button to select input signal channel.
7. Press the "Type" option button to select "Freq".

The corresponding icon and measure value will display on the third option area.

Measure signal frequency

1. Press the "MEASURE" button to display "Auto Measure Menu".
2. Press the top second option button.
3. Press the "Voltage" option button to enter the "Voltage measure menu".
4. Press the "Source" option button to select input signal channel.
5. Press the "Type" option button to select "Vpp".

The corresponding icon and measure value will display on the third option area.

4.2 Taking Cursor Measurements

- **Measuring Ring Frequency**

To measure the ring frequency at the rising edge of a signal, follow these steps:

1. Press the "CURSORS" button to see the "Cursor Menu".
2. Press the "Mode" button to select "Manual".

3. Press the “Type” option button and select “Time”.
 4. Press the “Source” option button and select “CH1”.
 5. Press the “CurA” button and turn the universal knob to place the cursor A on one peak of the ring.
 6. Press the “Cur B” button and turn the universal knob to place the cursor B on the nearest peak of the ring.
- You can see the delta time and frequency (the measured ring frequency) on the top left of the screen.

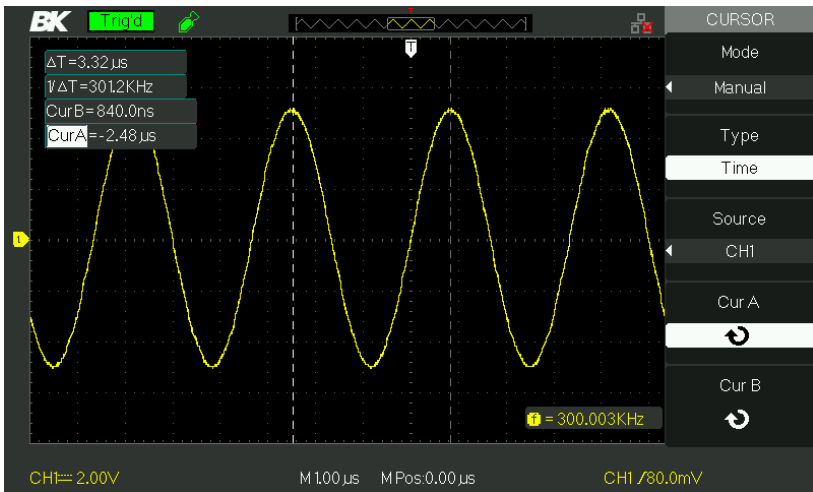

Figure 4.1 – Taking Cursor Measurements (Time)

- **Measuring Ring Amplitude**

To measure the amplitude, follow these steps:

1. Press the “CURSORS” button to see the Cursor Menu.
2. Press the “Mode” button to select “Manual”.
3. Press the “Type” option button and select “Voltage”.
4. Press the “Source” option button and select “CH1”.
5. Press the “CurA” option button and turn the universal knob to place the cursor A on the highest peak of the ring.

6. Press the “CurB” option button and turn the universal knob to place the cursor B on the lowest peak of the ring.

You can see the following measurements on the top of the left screen:

- The delta voltage (peak-to-peak voltage of the ringing)
- The voltage at Cursor A.
- The voltage at Cursor B.

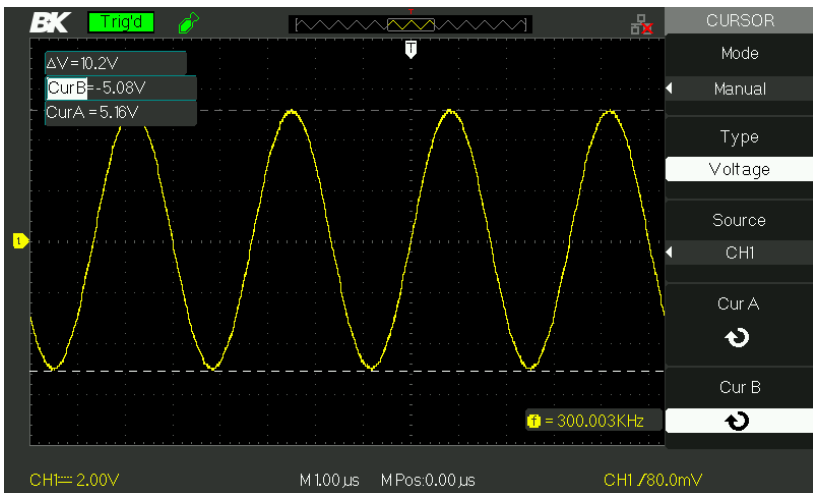

Figure 4.2 – Taking Cursor Measurements (Voltage)

4.3 Capturing a Single-Shot Signal

To capture a single event, you need to gather some knowledge of the signal in order to correctly set up the trigger level and slope. If you are not sure about the instance of the signal, you can observe it through auto or normal trigger mode to ensure the trigger level and slope will capture the signal.

The following steps show you how to use the oscilloscope to capture a single event.

1. Set the Probe option attenuation to 10X and set the switch to 10X on the probe.
2. Trigger set up:
 - a. Press “TRIG MENU” button to show the “Trigger Menu”
 - b. Under this menu, set the trigger type to “edge”, Edge type is “Rising”, source is “CH1”, trigger mode is “Single”, coupling is “DC”
 - c. Adjust the horizontal time base and vertical scale to the satisfied range
 - d. Turn the “LEVEL” knob to adjust the trigger level
3. Press the “RUN/STOP” button to start capturing

When the trigger conditions are satisfied, data appears on the display representing the data points that the oscilloscope obtained with one acquisition. Pressing the RUN/STOP button again rearms the trigger circuit and erases the display.

4.4 Analyzing Signal Details

You have a noisy signal displayed on the oscilloscope and need to know more about it. You suspect that the signal contains much more detail than you can now see in the display.

- **Looking at a Noisy Signal**

The signal appears noisy and you suspect that noise is causing problems in your circuit. To analyze the noise better, follow these steps:

1. Press the “ACQUIRE” button to see the acquire menu.
2. Press the “Acquisition” option button or turn the “Universal” knob to select “Peak Detect”.
3. If necessary, press the “DISPLAY” button to see “Display menu”. Turn the “Universal” knob to adjust waveform intensity and grid brightness to see the noise more clearly.

Peak detect emphasizes noise spikes and glitches in your signal, especially when the time base is set to a slow setting.

- **Separating the Signal from Noise**

To reduce random noise in the oscilloscope display, follow these steps:

1. Press the “ACQUIRE” button to display the acquire menu.
2. Press the “Acquisition” option button or turn the “Universal” knob to select “Average”.
3. Press the “Averages” option button to see the effects of varying the number of running averages on the waveform display.

Averaging reduces random noise and makes it easier to see the details of a signal.

4.5 Triggering on a Video Signal

Observe the video circuit in a piece of medical equipment and use the video trigger to obtain a stable display.

- **Triggering on Video Field**

To trigger on the video fields, follow these steps:

1. Press the “TRIGGER MENU” button to see “trigger menu”
2. Press the top option button and select “Video”.
3. Press the “source” option button and select “CH1”.
4. Press the “Sync” option button and select “Odd Field” or “Even Field”.
5. Press the “Standard” option button and select “NTSC”.
6. Turn the horizontal “Time/Div” knob to see a complete field across the screen.
7. Turn the vertical “Volts/Div” knob to ensure that the entire video signal is visible on the screen.

- **Triggering on Video Lines**

To trigger on the video lines, follow these steps:

1. Press the "TRIGGER MENU" button to see the trigger menu.
2. Press the top "option" button and select "Video"
3. Press the "Sync" option button and select "Line Num" and turn the universal knob to set a specific line number.
4. Press the "Standard" option button and select "NTSC".
5. Turn the "Time/Div" knob to see a complete video line across the screen.
6. Turn the "Volts/Div" knob to ensure that the entire video signal is visible on the screen.

4.6 Application of X-Y Function

- **Viewing Impedance Changes in a Network**

Connect the oscilloscope to monitor the input and output of the circuit. To view the input and output of the circuit in an XY display, follow these steps:

1. Press the "CH 1" MENU button and set the Probe option attenuation to 10X.
2. Press the "CH 2" MENU button and set the Probe option attenuation to 10X.
3. Set the switch of the probe to 10X.
4. Connect the channel 1 probe to the input of the network, and connect the channel 2 probe to the output.
5. Press the "AUTO" button.
6. Turn the "Volts/div" knobs to display approximately the same amplitude signals on each channel.
7. Press the "DISPLAY" button.
8. Press the Format option button and select "XY".
9. The oscilloscope displays a Lissajous pattern representing the input and output characteristics of the circuit.
10. Turn the Volts/div and VERTICAL POSITION knobs to optimize the display.

11. Press the "Persist" option button and select "Infinite".
12. Press the "Intensity" or "Brightness" option buttons and turn the "Universal" knob to adjust the contrast of the screen.

Apply the Ellipse method to observe the phase difference between the two channels

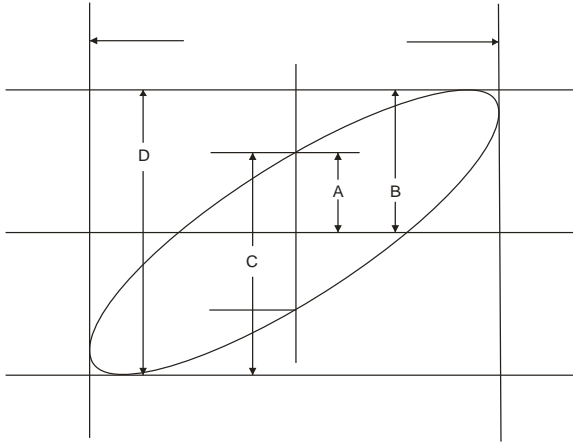

Figure 4.3 - Out of Phase Signals (45 degrees)

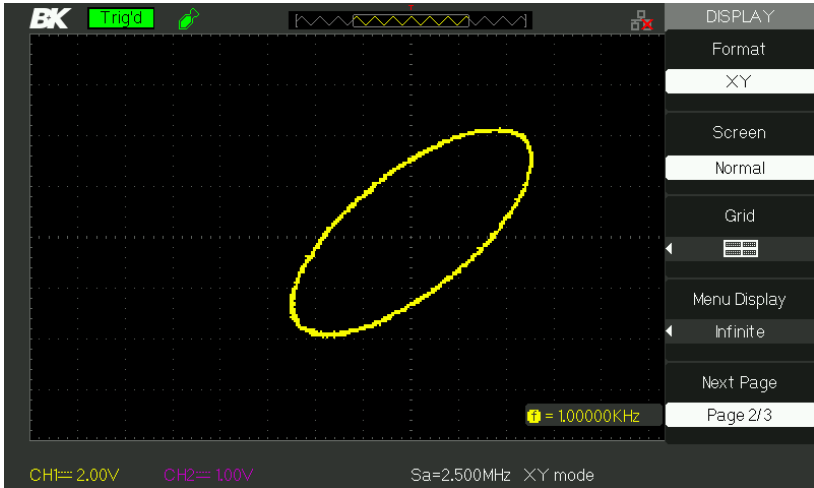

Figure 4.4 – Out of Phase Signals in XY Mode (45 degrees)

$\sin \theta = A/B$ or C/D where θ = phase shift (in degrees) between the two signals from the formula above, you could get:

$$\theta = \pm \arcsine (A/B) \text{ or } \pm \arcsine (C/D)$$

If the main axis of the ellipse is at quadrant II and IV, θ must be in the range of $(0-\pi/2)$ or $(3\pi/2-2\pi)$. If the main axis is at quadrant I and III, θ must be in the range of $(\pi/2-\pi)$ or $(\pi-3\pi/2)$.

4.7 Analyzing a Differential Communication Signal

You are having intermittent problems with a serial data communication link and suspect poor signal quality. Set up the oscilloscope to show a snapshot of the serial data stream so you can verify the signal levels and transition times.

Because this is a differential signal, you can use the math function of the oscilloscope to view a better representation of the waveform.

To activate the differential signals connected to channel 1 and channel 2, follow these steps:

1. Press the CH 1 button and set the Probe option attenuation to 10X.
2. Press the CH 2 button and set the Probe option attenuation to 10X.
3. Set the switches to 10X on the probes.
4. Press the AUTO button.
2. Press the "MATH" button to see the Math Menu.
3. Press the "Operation" option button and select " - ".
4. Press the "CH1- CH2" option button to display a new waveform that is the difference between the displayed waveforms.
5. You can adjust the vertical scale and position of the Math waveform. To do so, follow these steps:
 - i. Remove the channel 1 and channel 2 waveforms from the display.
 - ii. Turn the CH 1 and CH 2 VOLTS/DIV and VERTICAL POSITION knobs to adjust the vertical scale and position.

NOTE: First be sure to compensate both probes. Differences in probe compensation appear as errors in the differential signal.

5 Remote Control

The 2190E series digital storage oscilloscope can be remotely controlled by PC software application or user command programming.

The PC software provides most of the controls that emulate the front panel of the instrument. The rear panel USB device port is used to connect to a computer to allow for remote communication with the software. The software is free and can be downloaded at www.bkprecision.com.

Users can also control the oscilloscope by programming through standard SCPI (Standard Commands for Programmable Instruments) commands.

Remote communication commands are supported via the USB and LAN interface. Refer to the programming manual, available for download at www.bkprecision.com.

6 Message Prompts and Troubleshooting

6.1 Message Prompts

- **Trig level at limit!** : Prompts you that the trigger Level is at a limit when you turn the Trig level knob.
- **Horizon position at limit!** : Prompts you that the horizontal position is at a limit when you turn the horizontal position knob.
- **Volts/Div at limit!** : Prompts you that the vertical voltage has already reached the Min 2mV/div or the Max 5V/div.
- **Volts position at limit!** : The system would display this information when the vertical position is at a limit.
- **Sec/Div at limit!** : Prompts that the Time/Div is at full range while turning the horizontal scale knob.
- **Holdoff time at limit!** : Prompts you that the holdoff time setting has reached max or min value.
- **Function isn't useable!** : Under several special modes, some functions could not be running.
- **No signal!** : The system would display this information when the signal could not match the auto set condition while using the auto set function.
- **Adjust at limit!** : Prompts that the pulse width setting has reached min 20.0 ns or max 10.0 s.
- **Location Empty!** : If you have no stored waveforms or setups at specified location, the screen will display this information when you press the "Recall" button on this location.
- **USB Flash Drive Plug In!** : This information will appear when you insert the USB Flash Drive to the USB Host port.
- **USB Flash Drive Pull Out!** : This information will appear when you pull out the USB Flash Drive from the USB Host port.
- **Store Data Success!** : Saving setup data, waveform data or picture data to the internal memory of the oscilloscope or USB flash was successful.
- **Read Data Success!** : Read setup data or waveform data from the internal memory of the oscilloscope or USB flash was successful.

- **USB Flash Drive isn't connected!** : When the "Save To" option is set to "File" or the "Print Key" option is set to "Save Picture" in "Save/Recall" menu , press the "Save" option button or the "Time/div" knob before inserting the USB Flash Drive to the USB Host port or this will appear on the screen.
- **Record Wave Success!** : This message will appear when you finish recording waveforms.

6.2 Troubleshooting

1. **After the oscilloscope is powered on, the screen remains dark. Please do the following:**
 1. Check the power cable's connection.
 2. Check the rear AC main input switch located above the AC input receptacle. Make sure it is in the ON (|) position.
 3. After the inspecting above, restart the oscilloscope.
2. **If there is no signal wave in the screen after probing DUT for a signal, please do as follows:**
 1. Check whether the probe is connecting with the signal cable or not.
 2. Check whether the signal cable is connected with the BNC connector or not.
 3. Check the probe whether it's connected with the device under test (DUT) or not.
 4. Check the tested DUT to see if it produces the signal or not.
 5. Try to probe the DUT for signal again.
3. **If the value of the tested voltage is 10 times higher or lower than actual, please do the following:**

Check the attenuation quotient whether it matches the probe attenuation proportion or not.
4. **If waveform display is not stable, please do the following:**
 1. Check the signal source on the trigger interface whether or not it matches the signal channel.
 2. Check the trigger mode: normal signal should use the

- “edge” trigger mode. The video signal should use the “Video” Trigger mode. The signal would display steadily only when using matching trigger mode.
3. Attempt to change the “coupling” into “HF Reject” or “LF Reject” display, so that the High/low frequency noise will be filtered.
- 5. When pressing “RUN/STOP” button, nothing displays.**
Check whether or not the trigger mode on the trigger interface is in “normal” or “single”, and then check the trigger level to see if it is over the waveform range. If yes, please move the trigger level to the middle position or set the trigger mode to the “Auto” position. You can also press the “Auto” button to set it up automatically.
- 6. After the Acquisition is set to Averages or Display Persistence time is set too long, the waveform refreshes slowly.**
This is a normal condition for these settings.
- 7. The signal is displayed as a ladder-like waveform.**
1. This phenomenon is normal. The time base may be too slow. Turn the horizontal SCALE knob to increase horizontal resolution to improve the display.
 2. Maybe the display Type is set to “Vectors”. You could set it to Dots mode to improve the display.

7 Specifications

All specifications apply to measurements with a 10X probe. To verify that the oscilloscope meets specifications, the oscilloscope must first meet the following conditions:

- The oscilloscope must have been operating continuously for 30 minutes within the specified operating temperature.
- You must perform the Do Self Cal operation, accessible through the Utility menu, if the operating temperature changes by more than 5° C.
- The oscilloscope must be within the factory calibration interval.

All specifications are guaranteed unless noted “typical.”

	2190E
Inputs	
Input Coupling	AC, DC, GND
Input Impedance	1 MΩ ± 2% 16 pF ± 3 pF,
Maximum Input voltage	400 V (DC+AC PK-PK, 1 MΩ input impedance, X10), CAT I
Ch to Ch Isolation (Both channels in same V/div setting)	>100:1 at 100 MHz
Probe Attenuator	1X, 10X
Probe Attenuator Factors Set	1X, 5X, 10X, 50X, 100X, 500X, 1000X
Vertical System	
Vertical Sensitivity	2 mV/div -10 V/div (1-2-5 order)
Channel Voltage Offset Range	2mV –200mV: ±1.6V 206mV - 10V: ±40V
Vertical Resolution	8 bit
Channels	2
Analog Bandwidth (-3 dB)	100 MHz

Lower frequency limit (AC -3 dB)	≤10 Hz (at input BNC)
DC Gain Accuracy	5 mV/div to 10 V/div in Fixed Gain Ranges: <±3.0% 2 mV/div Variable Gain Ranges: <±4.0%
DC Measurement Accuracy: All Gain settings ≤ 100 mV/div	$\pm [3\% \times (\text{reading} + \text{offset}) + 1\% \times \text{offset} + 0.2 \text{ div} + 2 \text{ mV}]$
DC Measurement Accuracy: All Gain settings > 100 mV/div	$\pm [3\% \times (\text{reading} + \text{offset}) + 1\% \times \text{offset} + 0.2 \text{ div} + 100 \text{ mV}]$
Rise time	<3.5 ns
Overshoot, Typical (using 500 ps pulse)	<10% with probe or BNC input w/ 50 Ω feed thru
Math operation	+, -, ×, /, FFT
FFT	Window mode: Hanning, Hamming, Blackman, Rectangular
	Sampling points: 1024
Bandwidth limited	20 MHz ± 40% (Note: Bandwidth limited below 20 MHz when using probe in x1)
Horizontal System	
Real Time Sampling Rate	1 GSa/s (half-channel interleaved) 500 MSa/s (per channel)
Max. Equivalent Sampling Rate	50 GSa/s
Measure Display Modes	MAIN, WINDOW, WINDOW ZOOM, ROLL, X-Y
Time base Accuracy	±50 ppm measured over 1 ms interval
Horizontal Scan Range	2.5 ns/div – 50 s/div
	Scan Mode: 100 ms/div – 50 s/div (1-2.5-5 sequence)

Maximum Memory Length (interleaved)	40,000 points when time base is 2.5 ns to 50 ns, 20,000 points for 100 ns to 50 ms time base and dual channel operation More details can be found in the Save/Recall CSV section.
Trigger System	
Trigger Types	Edge, Pulse Width, Video, Slope, Alternative
Trigger Source	CH1, CH2, EXT, EXT/5, AC Line
Trigger Modes	Auto, Normal, Single
Trigger Coupling	AC, DC, LF reject, HF reject
Trigger Level Range	CH1,CH2: ± 6 divisions from center of screen
	EXT: ± 1.2 V
	EXT/5: ± 6 V
Trigger Displacement	Pre-trigger: Memory depth/(2*sampling), Delay Trigger: 271.04 div
Trigger Level Accuracy (typical) applicable for the signal of rising and falling time ≥ 20 ns	Internal: $\pm (0.2 \text{ div} \times \text{V/div})$ (within ± 4 divisions from center of screen) EXT: $\pm (6\% \text{ of setting} + 40 \text{ mV})$ EXT/5: $\pm (6\% \text{ of setting} + 200 \text{ mV})$
Trigger Sensitivity	For fixed gain ranges 1 Divisions: DC–10 MHz 1.5 Divisions: 10 MHz – max. bandwidth
	EXT: 200 mVpp DC–10 MHz, 300 mVpp 10 MHz – max. bandwidth
	EXT/5: 1 Vpp DC–10 MHz, 1.5 Vpp 10 MHz – max. bandwidth
Pulse Width Trigger	Trigger Modes: (>,<, =) + Pulse Width, (>, <, =) –Pulse Width
	Pulse Width Range: 20 ns – 10 s
Video Trigger	Support signal formats: PAL/SECAM, NTSC
Slope Trigger	(>,<, =) Positive slope, (>,<, =) Negative slope

	Time: 20 ns – 10 s
Alternative Trigger	CH1 trigger type: Edge, Pulse, Video, Slope
	CH2 trigger type: Edge, Pulse, Video, Slope
X-Y Mode	
X-Pole Input / Y-Pole Input	Channel 1 (CH1) / Channel 2 (CH2)
Phase Error	± 3 degrees
Hardware Frequency Counter	
Reading resolution	1 Hz
Range	DC Couple, 10 Hz to MAX Bandwidth
Signal Types	All trigger signals (except pulse width trigger and video trigger)
Control Panel Function	
Auto Set	Auto adjusting the Vertical, Horizontal system and Trigger Position
Save/Recall	20 setups and 10 captured waveforms to/from internal memory or to external USB flash drive.
Measurement System	
Measure (32 Types)	Vpp, Vmax, Vmin, Vamp, Vtop, Vbase, Vavg, Mean, Crms, Vrms, ROVShoot, FOVShoot, RPREShoot, FPREShoot, Rise time, Fall time, Freq, Period, +Wid, –Wid, +Dut, –Dut, BWid, Phase, FRR, FRF, FFR, FFF, LRR, LRF, LFR, LFF
Cursor Measure	Manual mode, Track mode and Auto mode
General	
Display	7.0" Color TFT LCD Display
Resolution	800 x 480 pixels
Display Color	24 bit
Display Contrast (Typical)	150:1
Backlight Intensity (Typical)	300 nit
Wave Display Range	8 x 18 div

Wave Display Mode	Dots, Vector	
Waveform Interpolation	Sin(x)/x, Linear	
Language	Simplified Chinese, Traditional Chinese, English, Arabic, French, German, Russian, Portuguese Spanish, Japanese, Korean, Italian	
Temperature	Operating: 10 °C to + 40 °C Not operating: -20 °C to + 60 °C	
Cooling	Cooling Fan	
Humidity	Operating: 85% RH, 40 °C, 24 hours Not operating: 85% RH, 65 °C, 24 hours	
Altitude	Operating: 3000m Not operating: 15,266m	
AC Input	100-240 VAC, CAT II, Auto selection	
Frequency	45 Hz to 440 Hz	
Power	50 VA Max	
Dimension	Length	323.1 mm
	Width	135.6 mm
	Height	157 mm
Weight	2.5 kg	

8 Calibration

We recommend a calibration interval of once per year.

SERVICE INFORMATION

Warranty Service: Please go to the support and service section on our website at www.bkprecision.com to obtain a RMA #. Return the product in the original packaging with proof of purchase to the address below. Clearly state on the RMA the performance problem and return any leads, probes, connectors and accessories that you are using with the device.

Non-Warranty Service: Please go to the support and service section on our website at www.bkprecision.com to obtain a RMA #. Return the product in the original packaging to the address below. Clearly state on the RMA the performance problem and return any leads, probes, connectors and accessories that you are using with the device. Customers not on an open account must include payment in the form of a money order or credit card. For the most current repair charges please refer to the service and support section on our website.

Return all merchandise to B&K Precision Corp. with prepaid shipping. The flat-rate repair charge for Non-Warranty Service does not include return shipping. Return shipping to locations in North America is included for Warranty Service. For overnight shipments and non-North American shipping fees please contact B&K Precision Corp.

B&K Precision Corp.
22820 Savi Ranch Parkway
Yorba Linda, CA 92887
www.bkprecision.com
714-921-9095

Include with the returned instrument your complete return shipping address, contact name, phone number and description of problem.

LIMITED ONE-YEAR WARRANTY

B&K Precision Corp. warrants to the original purchaser that its products and the component parts thereof, will be free from defects in workmanship and materials for a period of **one year** from date of purchase.

B&K Precision Corp. will, without charge, repair or replace, at its option, defective product or component parts. Returned product must be accompanied by proof of the purchase date in the form of a sales receipt.

To help us better serve you, please complete the warranty registration for your new instrument via our website www.bkprecision.com

Exclusions: This warranty does not apply in the event of misuse or abuse of the product or as a result of unauthorized alterations or repairs. The warranty is void if the serial number is altered, defaced or removed.

B&K Precision Corp. shall not be liable for any consequential damages, including without limitation damages resulting from loss of use. Some states do not allow limitations of incidental or consequential damages. So the above limitation or exclusion may not apply to you.

This warranty gives you specific rights and you may have other rights, which vary from state-to-state.

B&K Precision Corp.
22820 Savi Ranch Parkway
Yorba Linda, CA 92887
www.bkprecision.com
714-921-9095

BK PRECISION[®]

22820 Savi Ranch Parkway
Yorba Linda, CA 92887
www.bkprecision.com

© 2017 B&K Precision Corp.

V010917