

# SRPE-50E1A0

## Non-Isolated DC-DC Converter

The Bel SRPE-50E1A0 is part of the non-isolated dc to dc converter Power Module series. The modules use a Vertical SMT package. These converters are available in a range of output voltages from 0.6 Vdc to 2.0 Vdc over a wide range of input voltage ( $V_{in} = 7.5 - 13.2$  Vdc).

### Key Features & Benefits

- 7.5-13.2 VDC Input / 0.6-2.0 VDC @ 50 A Output
- Non-isolated
- Fixed frequency
- High efficiency
- High Power Density
- Overtemperature Shutdown
- Wide Input Voltage Range
- Low Cost
- Wide Output Trim Range
- Output Over-Voltage Shutdown
- OCP/SCP
- Power Good Signal
- Remote Sense
- Remote On/Off
- Undervoltage lockout
- Wide Operating Temperature Range (0 °C - 50 °C)
- Class 2, Category 2, Isolated DC/DC Converter (refer to IPC-9592B)



### Applications

- Networking
- Computers and peripherals
- Telecommunications

## 1. MODEL SELECTION

MODEL NUMBER	OUTPUT VOLTAGE	INPUT VOLTAGE	MAX. OUTPUT CURRENT	MAX. OUTPUT POWER	TYPICAL EFFICIENCY
SRPE-50E1A0	0.6-2.0 VDC	7.5-13.2 VDC	50A	100 W	91%

**NOTE:** Add "G" or "R" suffix at the end of the model number to indicate packaging.

### PART NUMBER EXPLANATION

S	R	PE	-	50	E	1A	0	x
Mounting Type	RoHS Status	Series Name		Output Power	Input Range	Output Voltage	Active Logic	Package Type
Surface mount	RoHS	SMD		100 W	7.5-13.2 V	0.6-2.0 V	0-Active High	G – Tray package R – Tape and Reel packaging

## 2. ABSOLUTE MAXIMUM RATINGS

PARAMETER	DESCRIPTION	MIN	TYP	MAX	UNITS
Continuous non-operating Input Voltage		-0.3	-	15	V
Remote On/Off		-0.3	-	15	V
Ambient temperature		0	-	50	°C
Storage Temperature		-40	-	125	°C
Altitude		-	-	2000	m

**NOTE:** Ratings used beyond the maximum ratings may cause a reliability degradation of the converter or may permanently damage the device.

## 3. INPUT SPECIFICATIONS

All specifications are typical at 25°C unless otherwise stated.

PARAMETER	DESCRIPTION	MIN	TYP	MAX	UNIT
Operating Input Voltage		7.5	12	13.2	V
Input Current (full load)	V <sub>in</sub> =12V, V <sub>o</sub> =2V, I <sub>o</sub> =50A	8.8	9.3	10.3	A
	V <sub>in</sub> =12V, V <sub>o</sub> =0.9V, I <sub>o</sub> =50A	4.1	4.6	5.6	A
	V <sub>in</sub> =12V, V <sub>o</sub> =0.6V, I <sub>o</sub> =50A	2.8	3.3	4.3	A
Input Current (no load)	V <sub>in</sub> =12V, V <sub>o</sub> =0.9V	110	135	160	mA
	V <sub>in</sub> =12V, V <sub>o</sub> =0.6V	101	126	150	mA
	V <sub>in</sub> =12V, V <sub>o</sub> =2V	165	190	215	mA
Remote Off Input Current	V <sub>in</sub> =12V	15	20	25	mA
Input Reflected Ripple Current (pk-pk)	V <sub>in</sub> =12V, V <sub>o</sub> =0.9V 1uH inductor×1, 100uf/100V×1 @25°C.	-	45	60	mA
Input Reflected Ripple Current (rms)		-	11	20	mA
Turn-on Voltage Threshold		7	7.2	7.5	V
Turn-off Voltage Threshold		6.2	6.4	7	V

**CAUTION:** All specifications are typical at 25 °C unless otherwise stated.

#### 4. OUTPUT SPECIFICATIONS

All specifications are typical at nominal input, full load at 25°C unless otherwise stated.

PARAMETER	DESCRIPTION	MIN	TYP	MAX	UNIT
Output Voltage Set Point	Vin=12V, Iout=full load, Ta=25°C.	-3	-	3	% Vo, set
Load Regulation	Vin=12V, Io=0-20A, Ta=25°C	-2	-	2	% Vo, set
Line Regulation	Vin=8-14V, Io=10A, Ta=25°C	-2	-	2	% Vo, set
Regulation Over Temperature		-2	-	2	% Vo, set
Output Ripple and Noise(PK-Pk)	Vin=12V, Iout=full load, Ta=25°C.	-	15	30	mV
Output Ripple and Noise(RMS)		-	5	10	mV
Output Current Range		0	-	50	A
Output DC Current Limit		60	-	120	A
Turn on Time		-	3.5	5	ms
Output Capacitance	Recommendation: 6*22uF 0805, 6.3V ceramic caps 3*470uF 7mohm Polymer Caps	1300	1542	1800	uF
<b>Transient Response</b>					
ΔV 50%~75% of Max Load	di/dt=1A/us, Vin=12Vdc, Vo=0.9Vdc, Ta=25°C, with 1*0.1uF+1*1uF+ 6*22uF ceramic capacitor and 3*470uF polymer cap at output.	-	40	70	mV
Settling Time		-	50	80	us
ΔV 75%~50% of Max Load		-	40	70	mV
Settling Time		-	50	80	us

#### 5. GENERAL SPECIFICATIONS

PARAMETER	DESCRIPTION	MIN	TYP	MAX	UNIT
Efficiency	The efficiency is measured at Vin=12V, Vout=2V, Iout=50A and Ta=25°C.	89.5	90.5	-	%
Switching Frequency	For per phase	300	350	400	kHz
Over Temperature Protection		-	-	-	°C
Output Voltage Trim Range (Wide Trim)		0.6	-	2	V
Weight		-	19	-	g
MTBF	Calculated Per Telcordia SR-332, Issue 3(Vin=12V,Vo=0.9V,Io=50A,Ta=40C, with 300 LFM, FIT=10%/MTBF)	-	31.7	-	M hrs
FIT		-	31.5	-	-
Dimensions			1.45 x 0.95 x 0.62		Inches
Inches (L x W x H)			36.83 x 24.13 x 15.75		Millimeters
Millimeters (L x W x H)					

#### 6. CONTROL SPECIFICATIONS

PARAMETER	DESCRIPTION	MIN	TYP	MAX	UNIT
<b>Remote On/Off</b>					
Signal Low (Unit Off)	Remote On/Off pin open, unit off.	0	-	0.5	V
Signal High (Unit On)		1.8	-	15	V



Asia-Pacific  
+86 755 298 85888

Europe, Middle East  
+353 61 225 977

North America  
+1 408 785 5200

7. EFFICIENCY DATA

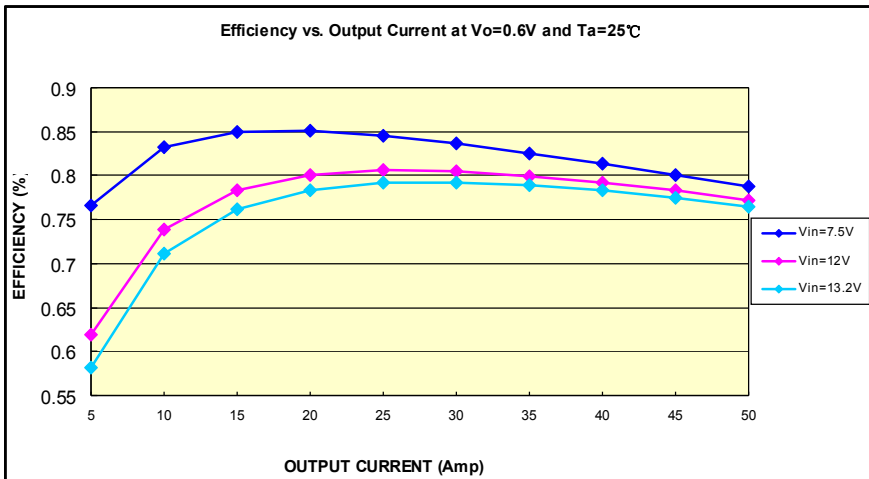
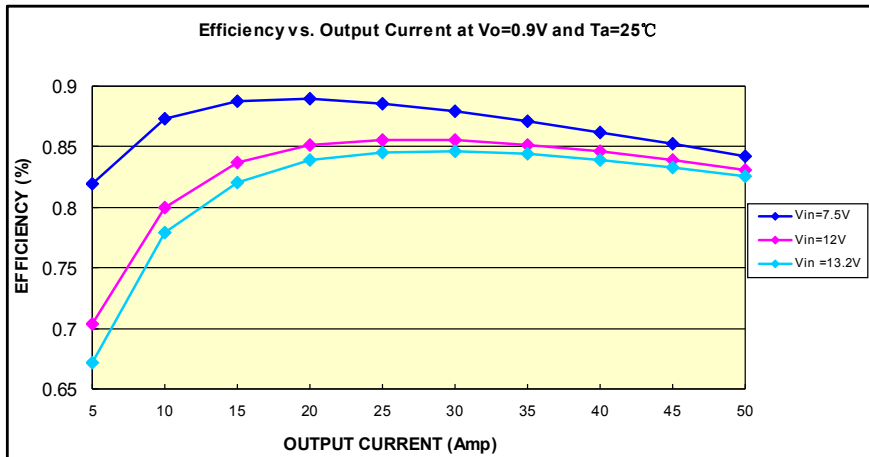
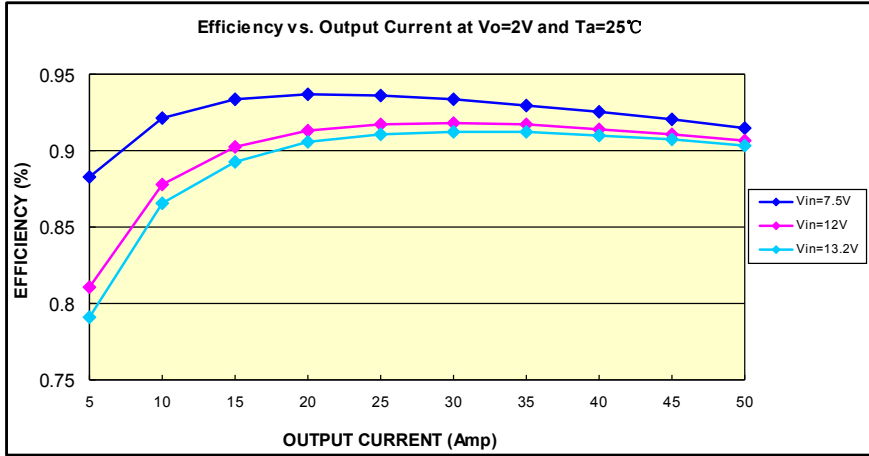

**8. INPUT NOISE**

Input reflected ripple current  
Testing setup

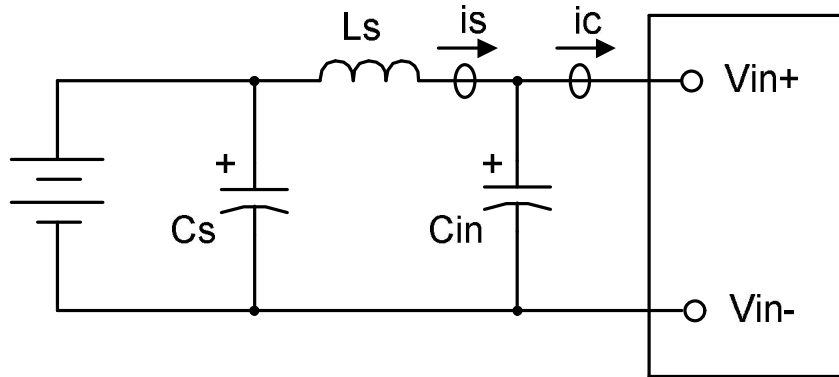

Notes and values in testing.

- is*: Input Reflected Ripple Current
- ic*: Input Terminal Ripple Current
- Ls*: Simulated Source Impedence (1μH)
- Cs*: Offset possilbe source Impedence (100μF, ESR<0.2Ω @ 100kHz, 20C )
- Cin*: Electrolytic capacitor, should be as closed as possible to the power module to swallow *ic* ripple current and help with stability. Recommendation: 100μF, ESR<0.2Ω @ 100kHz, 20C.

Below measured waveforms are based on above simulated and recommended inductance and capacitance.

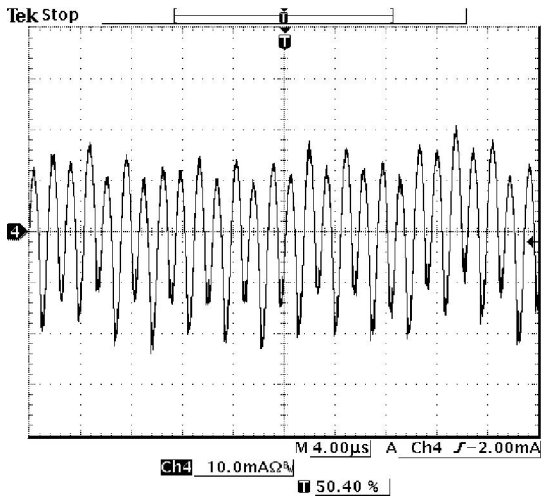

*is* (input reflected ripple current), AC component

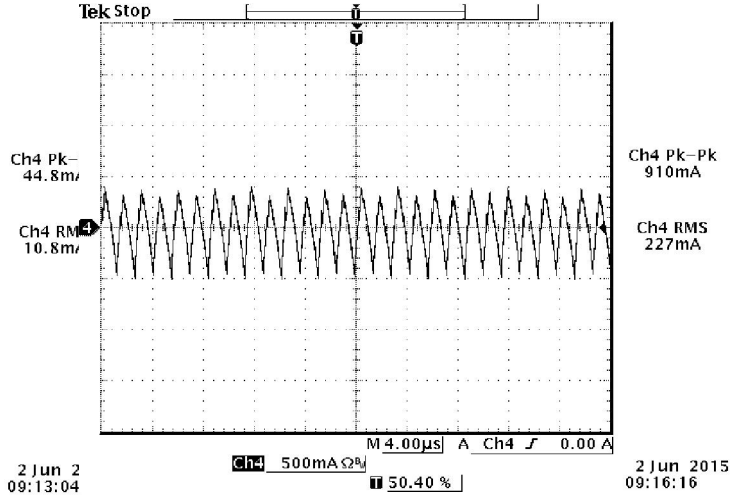

*ic* (input terminal ripple current), AC component

**Note:**  $V_{in}=12V$ ,  $V_o=0.9V$ ,  $I_o=50A$ , with  $1*0.1\mu f+1*1\mu f+6*22\mu f$  ceramic and  $3*470\ \mu F$  polymer capacitor at the output,  $T_a=25\ deg\ C$ .

**9. THERMAL DERATING CURVE**

Hot spot location and allowed maximum temperature

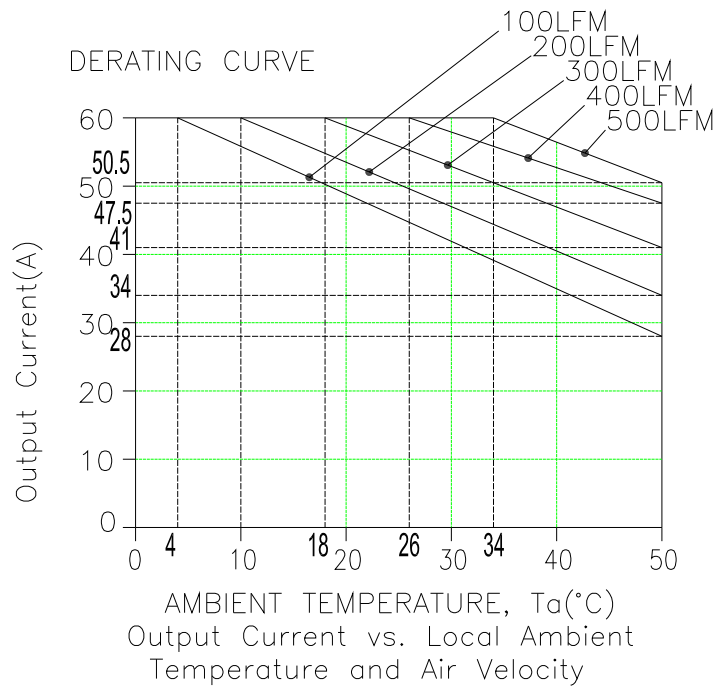
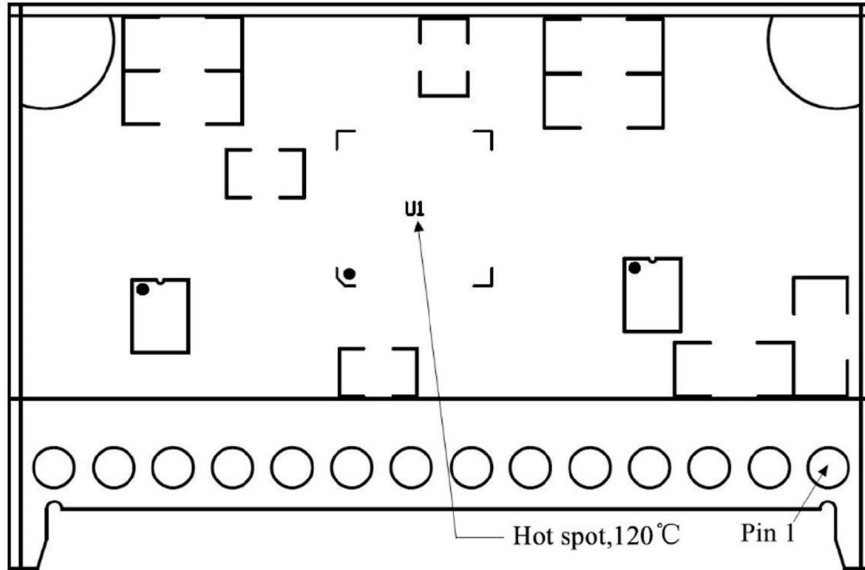

$V_{in}=12V, V_o=0.9V$

10. RIPPLE AND NOISE WAVEFORM

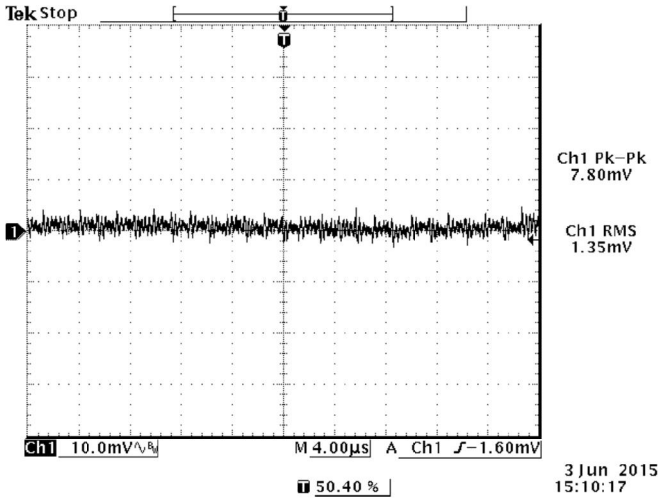

$V_{in}=12V, V_o=0.6V, I_o=50A$

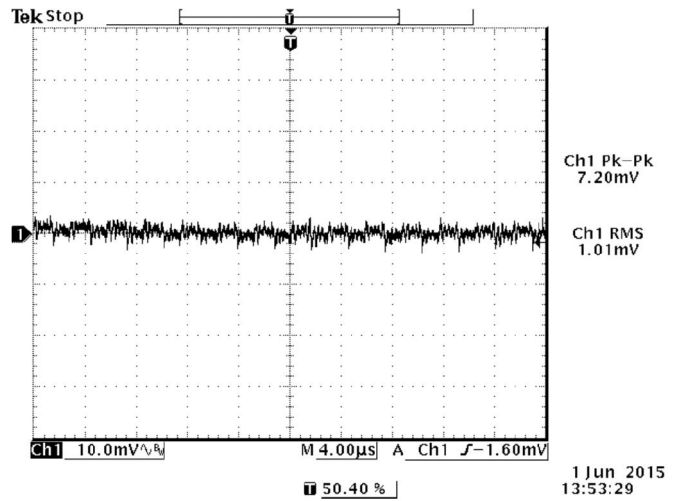

$V_{in}=12V, V_o=0.9V, I_o=50A$

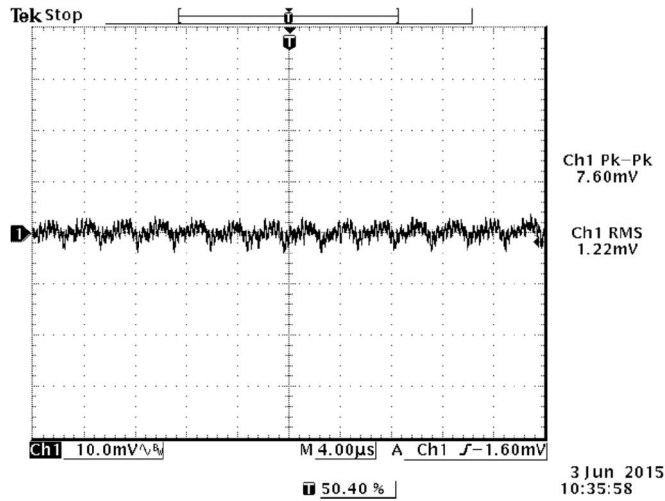

$V_{in}=12V, V_o=2V, I_o=50A$

**Note:** Ripple and noise at full load, 0-20MHz BW, with 1\*0.1µf+1\*1µf+6\*22µf ceramic and 3\*470 µF polymer capacitor at the output,  $T_a=25$  deg C.



**11. TRANSIENT RESPONSE WAVEFORMS**

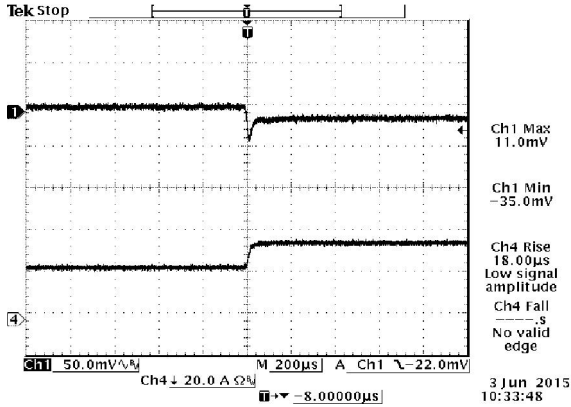

50%-75% Load Transients at  $V_{in}=12V$ ,  $V_{out}=2V$

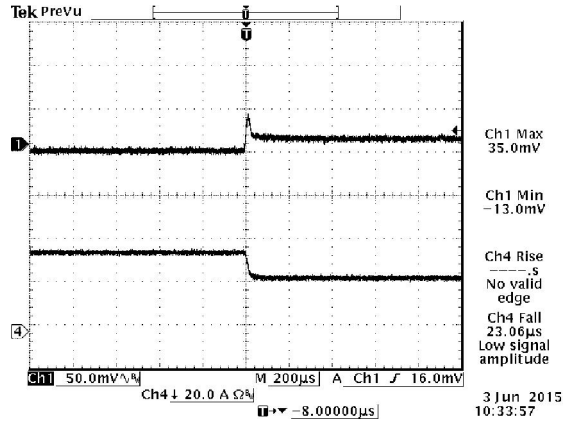

75%-50% Load Transients at  $V_{in}=12V$ ,  $V_{out}=2V$

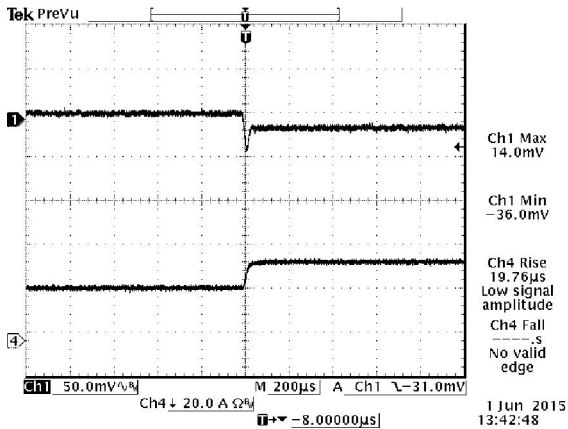

50%-75% Load Transients at  $V_{in}=12V$ ,  $V_{out}=0.9V$

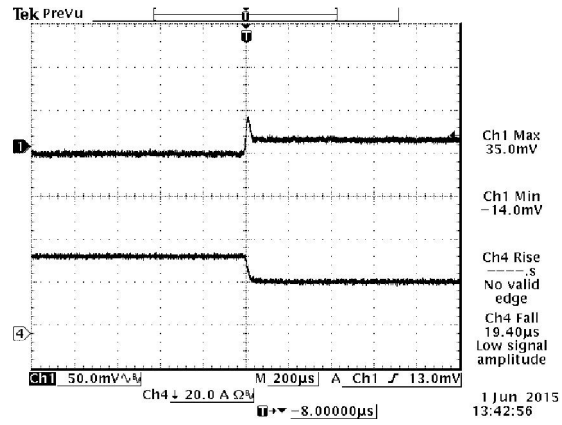

75%-50% Load Transients at  $V_{in}=12V$ ,  $V_{out}=0.9V$

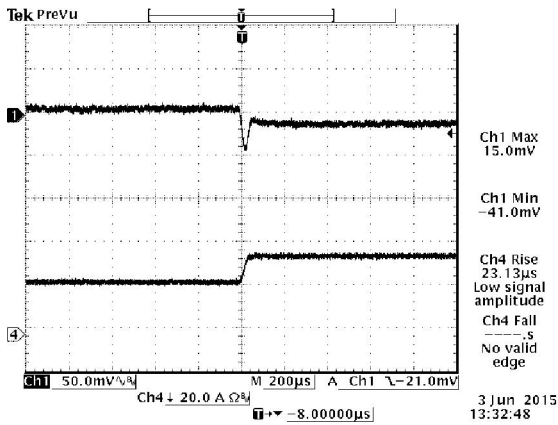

50%-75% Load Transients at  $V_{in}=12V$ ,  $V_{out}=0.6V$

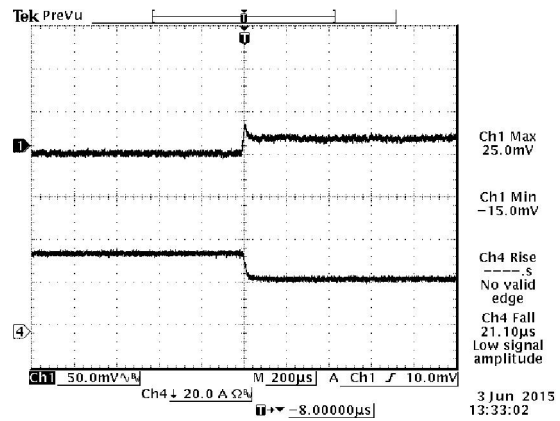

75%-50% Load Transients at  $V_{in}=12V$ ,  $V_{out}=0.6V$

**Note:** Transient response at  $di/dt=1A/\mu s$ , with  $1*0.1\mu f+1*1\mu f+6*22\mu f$  ceramic and  $3*470\mu F$  polymer capacitor at the output,  $T_a=25\text{ deg C}$ .



12. STARTUP&SHUTDOWN

Rise time

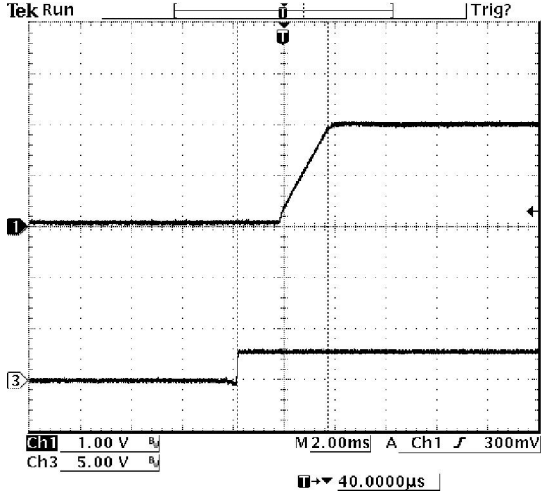

Vin=12V, Vo=2V, Io=50A

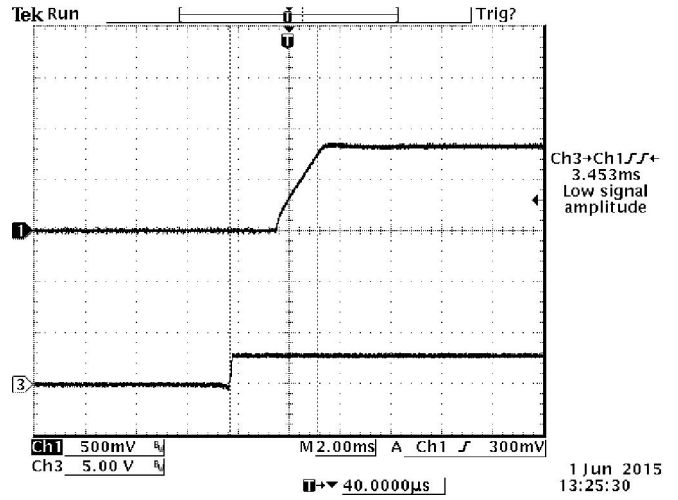

Vin=12V, Vo=0.9V, Io=50A

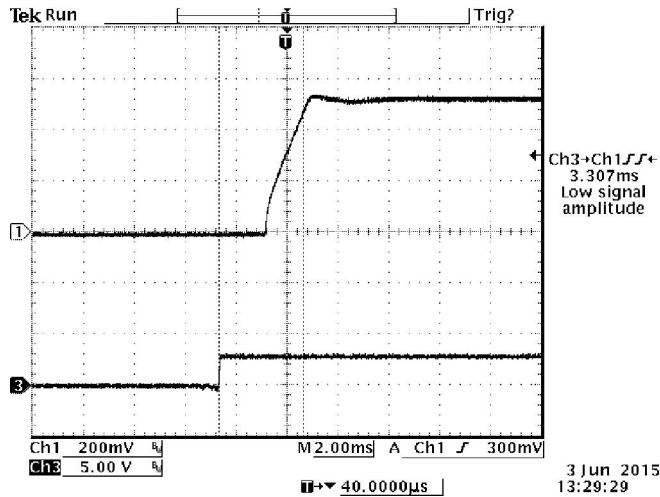

Vin=12V, Vo=0.6V, Io=50A

Note: With 1\*0.1µf+1\*1µf+6\*22µf ceramic and 3\*470 µF polymer capacitor at the output, Ta=25 deg C.



Asia-Pacific  
+86 755 298 85888

Europe, Middle East  
+353 61 225 977

North America  
+1 408 785 5200

**13. TRIM**

*Output Voltage Set-Point Adjustment*

*Maximum trim up voltage is 2V.*

*Minimum trim up voltage is 0.6V.*

*1. Trim up circuit (using an external resistor)*

*Equations for calculating the trim resistor are shown below.*

*The Trim Up resistor should be connected between the Trim pin and GND pin.*

$$R_{trim} = \frac{1.2}{V_o - 0.6} (K\Omega)$$

SRPE-50E1A0 Trim up Resistor Calculate Unit: KΩ

*V<sub>o</sub> is the desired output voltage*

*R<sub>trim</sub> is the required resistance between TRIM and GND*

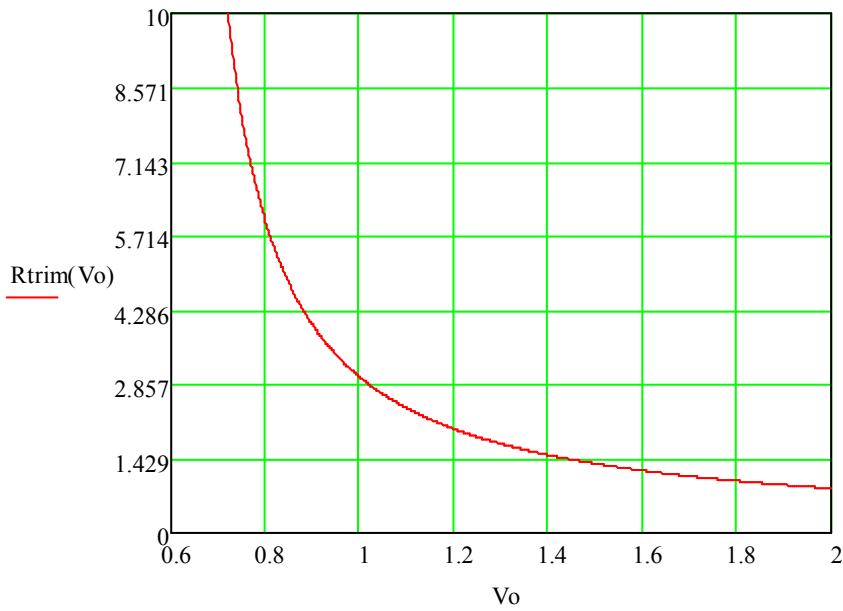
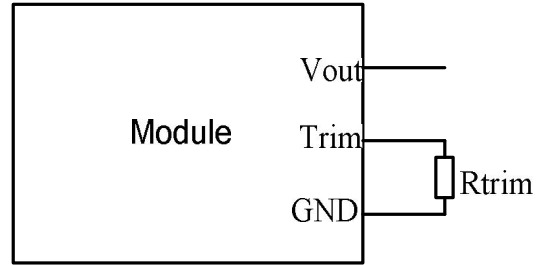

## TRIM(CONTINUED)

2. Trim up circuit (using external PWM signal)  
Equations for calculating the duty cycle are shown below.

$$V_o(D) = 2.265 - 9.13D$$

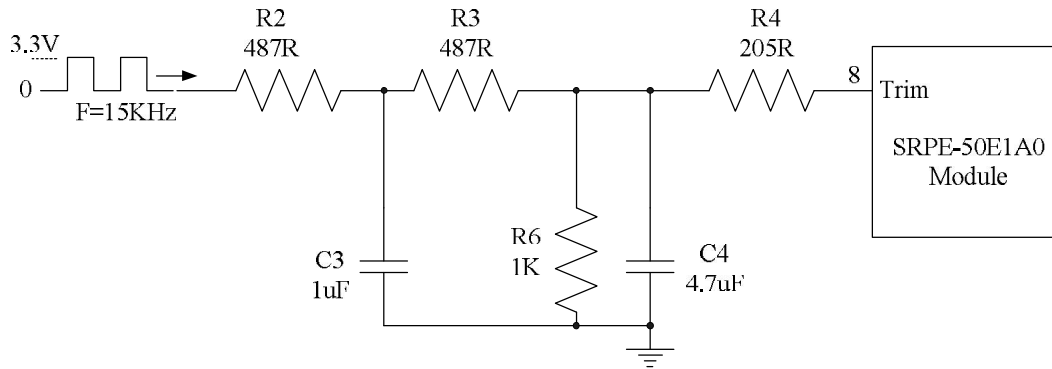

SRPE-50E1A0 Trim up duty cycle Calculate  
 $V_o$  is the desired output voltage  
 $D$  is the external PWM signal duty cycle.

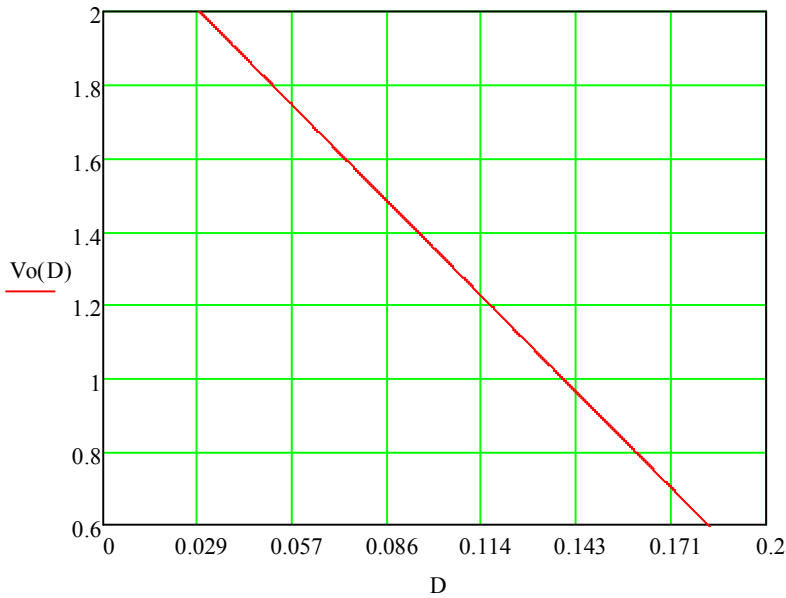

**14. OCP**

To provide protection in a fault output overload condition, the module is equipped with internal current-limiting circuitry and can endure current limiting for a few milli-seconds. If the overcurrent condition persists beyond a few milliseconds, the module will shut down into hiccup mode and restart once every 14mS. The module operates normally when the output current goes into specified range. The typical average output current is 3A during hiccup.

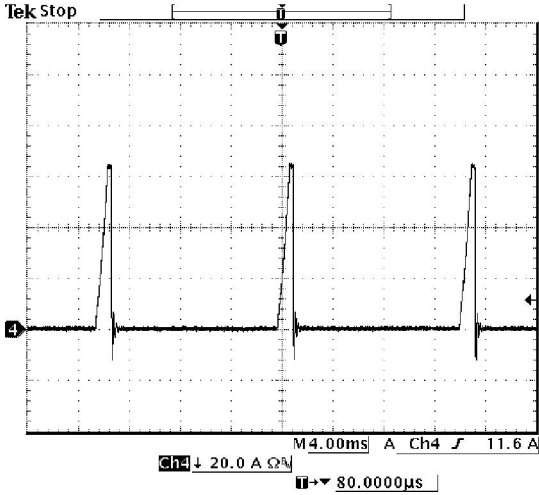

Vin=12V, Vo=2V

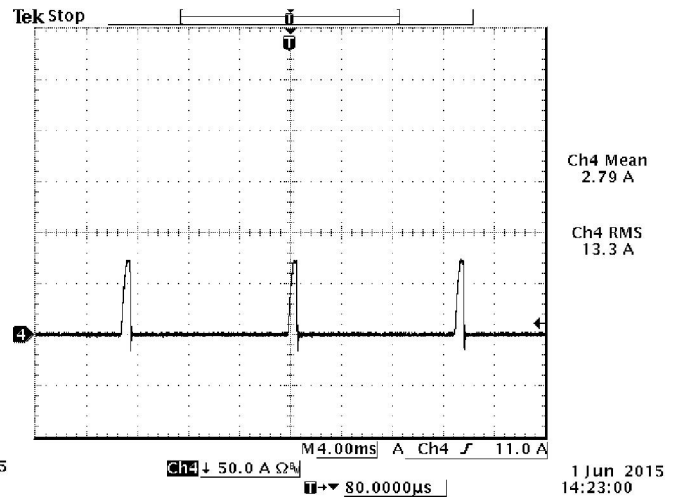

Vin=12V, Vo=0.9V

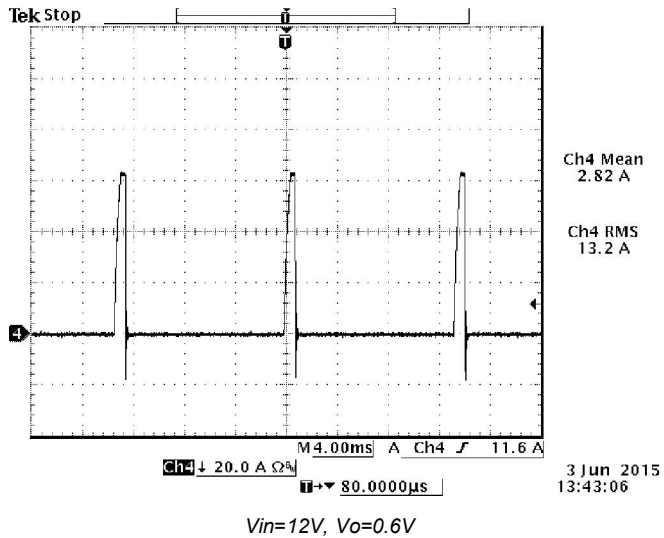

**15. INPUT UNDER-VOLTAGE LOCKOUT**

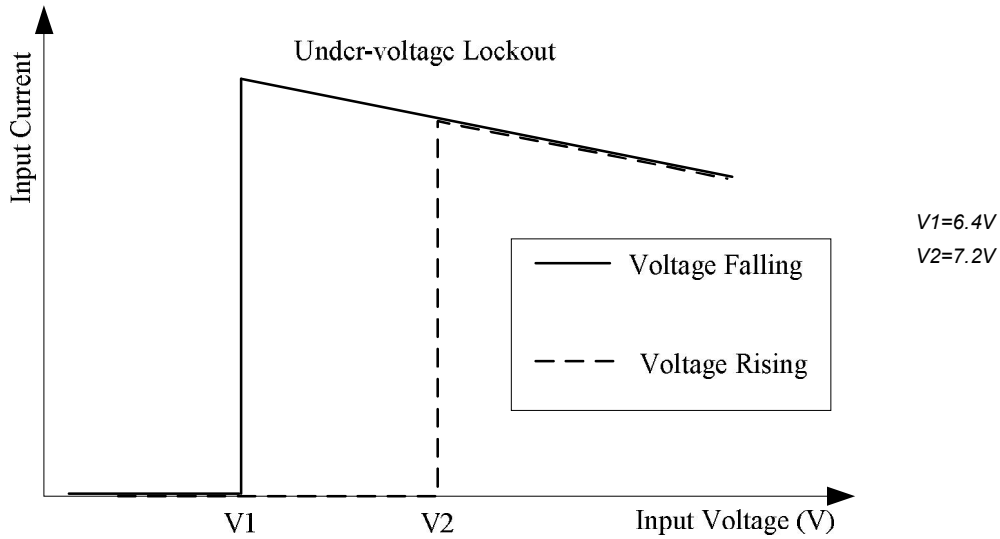

**16. POWER GOOD**

1. This module has a power good indicator output. Power good pin used positive logic and is open collector.
2. Maximum power good pin sinking current is 10mA.
3. The maximum voltage pulled up externally on Power Good pin should not exceed 5V.
4. When the output reaches 90% of the nominal set-point, the power good pin will be pulled high.

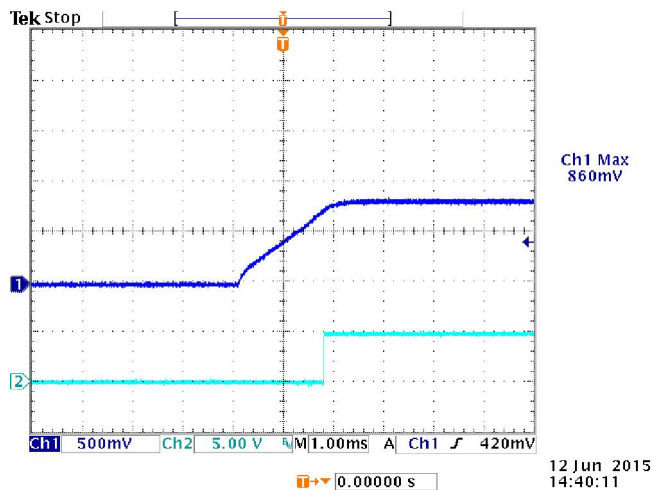

Typical Start-up Using Remote ON/OFF ( $V_{in}=12.0V$ ,  $V_o=0.9V$ ,  $I_o=50A$ )  
 CH1=Vout CH2: PG



Asia-Pacific  
 +86 755 298 85888

Europe, Middle East  
 +353 61 225 977

North America  
 +1 408 785 5200

## 17. SOLDERING INFORMATION

The SRPE-50E1A0G modules are designed to be compatible with a Paste-In-Hole assembly process. The suggested Pb-free solder paste is Sn/Ag/Cu(SAC). The recommended reflow profile using Sn/Ag/Cu solder is shown in the following. Recommended reflow peak temperature is 245 °C while the part can withstand peak temperature of 260 °C maximum for 10seconds. This profile should be used only as a guideline. Many other factors influence the success of SMT reflow soldering. Since your production environment may differ, please thoroughly review these guidelines with your process engineers.

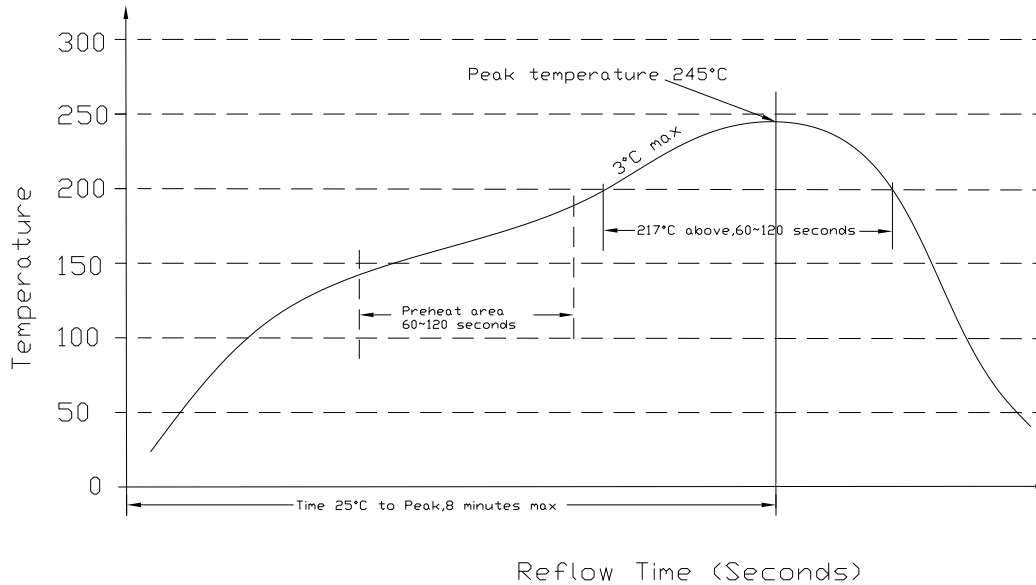

## 18. MSL RATING

The SRPE-50E1A0G modules have a MSL rating of 3.

## 19. STORAGE AND HANDLING

The SRPE-50E1A0G modules are designed to be compatible with J-STD-033 Rev:A (Handling, Packing, Shipping and Use of Moisture /Reflow Sensitive surface Mount devices). Moisture barrier bags (MBB) with desiccant are applied. The recommended storage environment and handling procedure is detailed in J-STD-033.

## 20. PRE-BAKING

This component has been designed, handled, and packaged ready for pb-free reflow soldering. If the assembly shop follows J-STD-033 guidelines, no pre-bake of this component is required before being reflowed to a PCB. However, if the J-STD-033 guidelines are not followed by the assembler, Bel recommends that the modules should be pre-baked @ 120~125 °C for a minimum of 4 hours (preferably 24 hours) before reflow soldering.

## 21. MECHANICAL DIMENSIONS

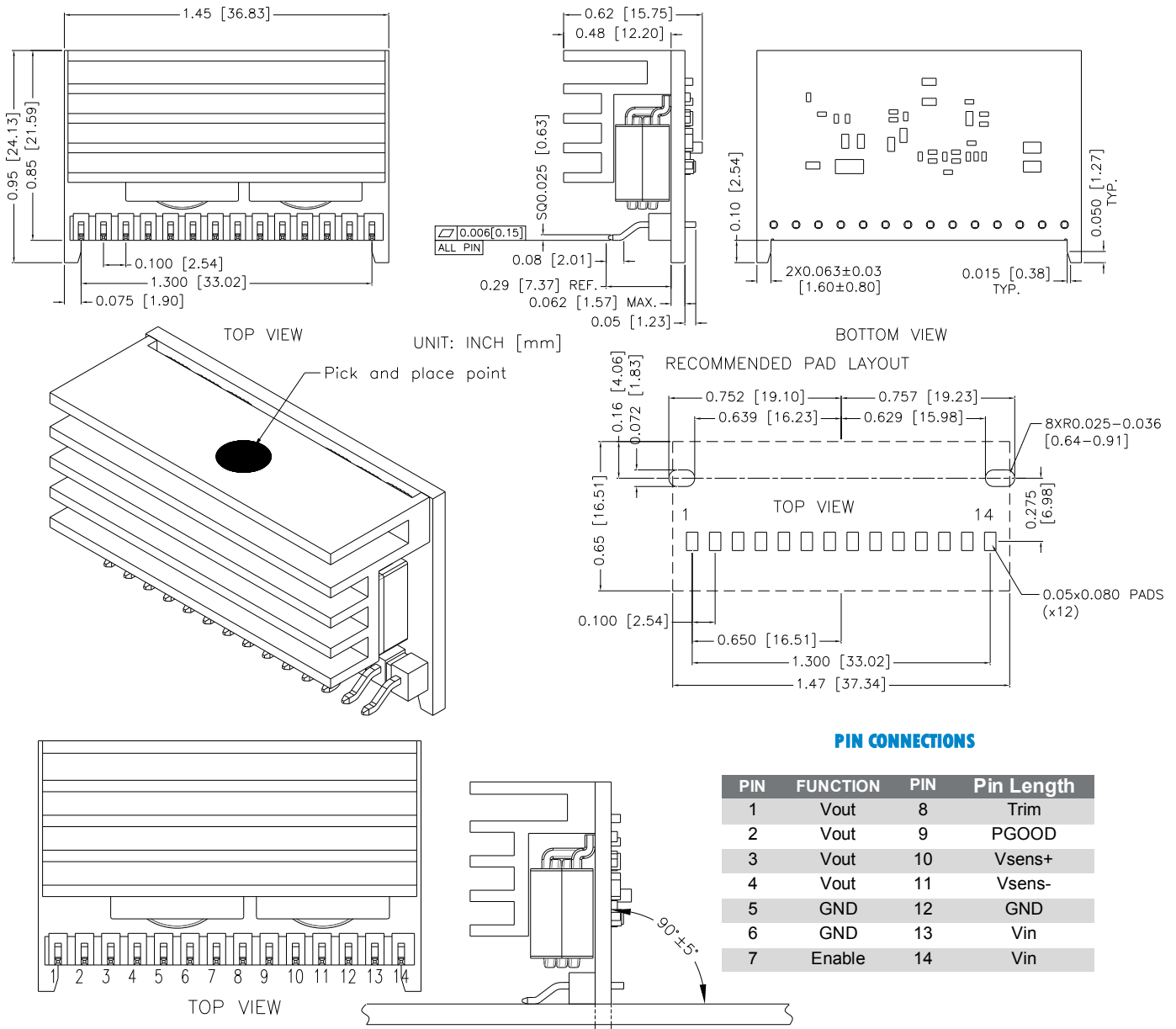

**NOTES:**

All Pins: Material - Copper Alloy;  
 Finish – 3 micro inches minimum Gold over 50 micro inches minimum Nickel plate.

- 1) Undimensioned components are shown for visual reference only.
- 2) All dimensions in inches; Tolerances: x.xx +/-0.02 in [0.51 mm]. x.xxx +/-0.010 in [0.25 mm].



Asia-Pacific  
 +86 755 298 85888

Europe, Middle East  
 +353 61 225 977

North America  
 +1 408 785 5200



**For more information on these products consult: [tech.support@psbel.com](mailto:tech.support@psbel.com)**

**NUCLEAR AND MEDICAL APPLICATIONS** - Products are not designed or intended for use as critical components in life support systems, equipment used in hazardous environments, or nuclear control systems.

**TECHNICAL REVISIONS** - The appearance of products, including safety agency certifications pictured on labels, may change depending on the date manufactured. Specifications are subject to change without notice.