



PART No. 1418N4SSS12

for more information visit
www.hammfg.com

Data subject to change without notice

Isometric drawing Not to Scale

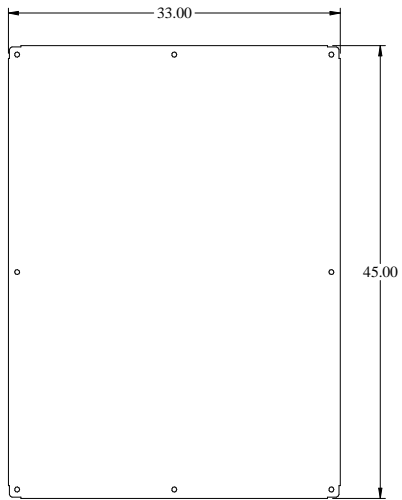

INNER PANEL

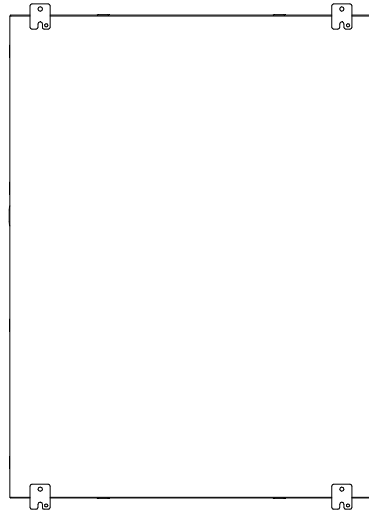

BACK VIEW

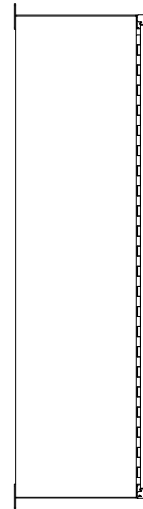

SIDE VIEW

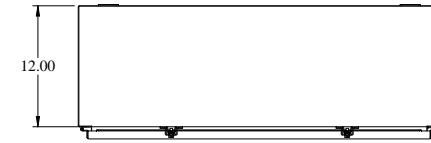

TOP VIEW

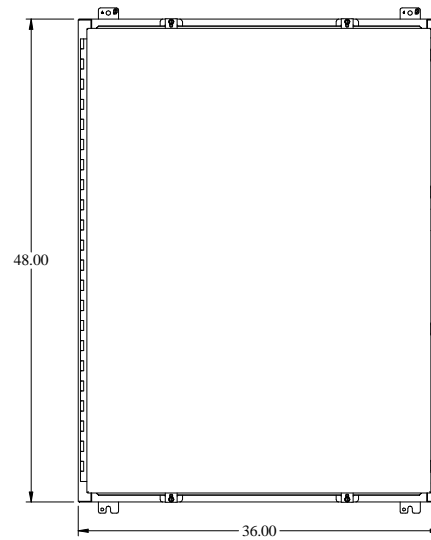

FRONT VIEW

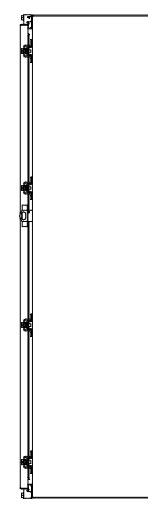

SIDE VIEW

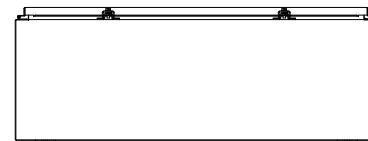

BOTTOM VIEW

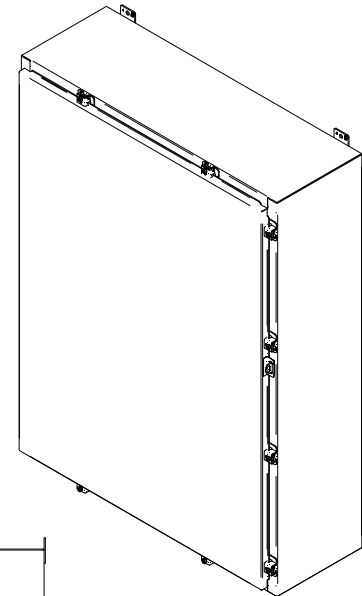

ISOMETRIC VIEW