

DETAILS

Product Number	CS14144_STRADA-IP-2X6-ME
Family	Strada
Type	Assembly
Color	white
Diameter	71,4x173 mm
Height	8,42 mm
Style	rectang
Optic Material	
Holder Material	
Fastening	
Status	production ready
ROHS Compliant	Yes
Date Updated	8/09/2016



OPTICAL PROPERTIES

LED	Viewing	Light	Efficiency	cd/lm	Connector
	Angle	Beam			
XT-E	asymmetric deg	Asymmetric	93 %	0.823	-
XP-L	asymmetric deg	Asymmetric	94 %	0.620	-
XHP35 HD	sim: Asymmetric	Asymmetric	sim: 88 %	sim: 0.530	-
XHP35 HI	sim: Asymmetric	Asymmetric	sim: 90 %	sim: 0.540	-
XP-G2	asymmetric deg	Asymmetric	94 %	0.820	-
XP-G3	sim: Asymmetric	Asymmetric	sim: 88 %	sim: 0.550	-
XP-L2	Asymmetric deg	Asymmetric	94 %	0.580	-
H35C1 (LEMWA33)	Asymmetric deg	Asymmetric	94 %	0.670	-
LUXEON T	Asymmetric deg	Asymmetric	96 %	-	-
LUXEON XR-TX (L2T0-xyy012M)	Asymmetric deg	Asymmetric	94 %	0.850	-
NVSxx19B/NVSxx19C	Asymmetric deg	Asymmetric	96 %	0.800	-
Duris S8	sim: Asymmetric	Asymmetric	sim: 90 %	sim: 0.580	-
Duris P8	sim: Asymmetric	Asymmetric	sim: 90 %	sim: 0.640	-
Acrich MJT 4040	sim: Asymmetric	Asymmetric	-	-	-
Z5M1/Z5M2	sim: Asymmetric	Asymmetric	sim: 90 %	sim: 0.840	-
Z8Y22P	Asymmetric deg	Asymmetric	94 %	0.730	-
TL1L3	sim: Asymmetric	Asymmetric	sim: 95 %	-	-
TL1L2	sim: Asymmetric	Asymmetric	sim: 88 %	-	-
TL1L4	Asymmetric deg	Asymmetric	92 %	0.750	-

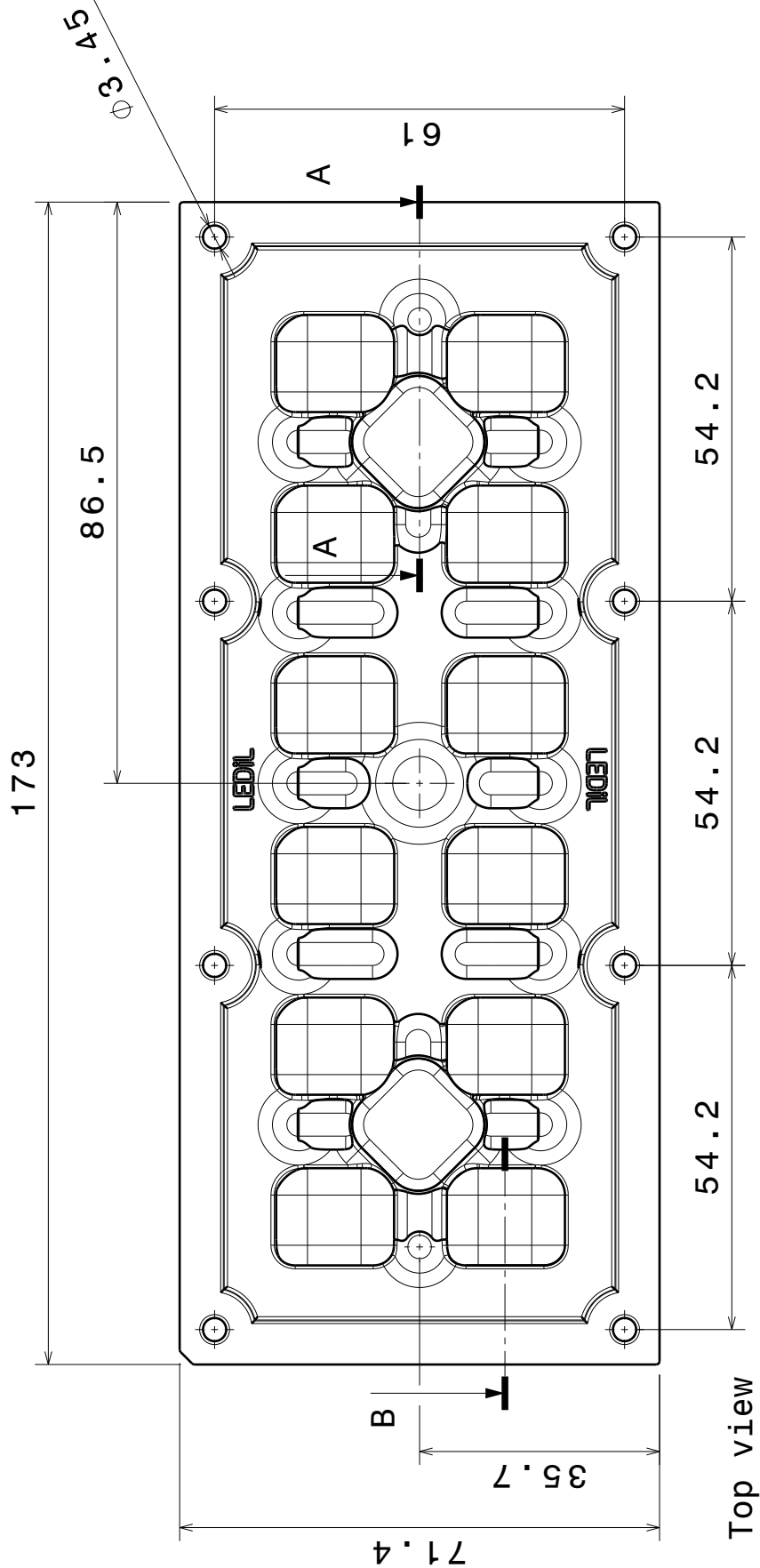

Top view

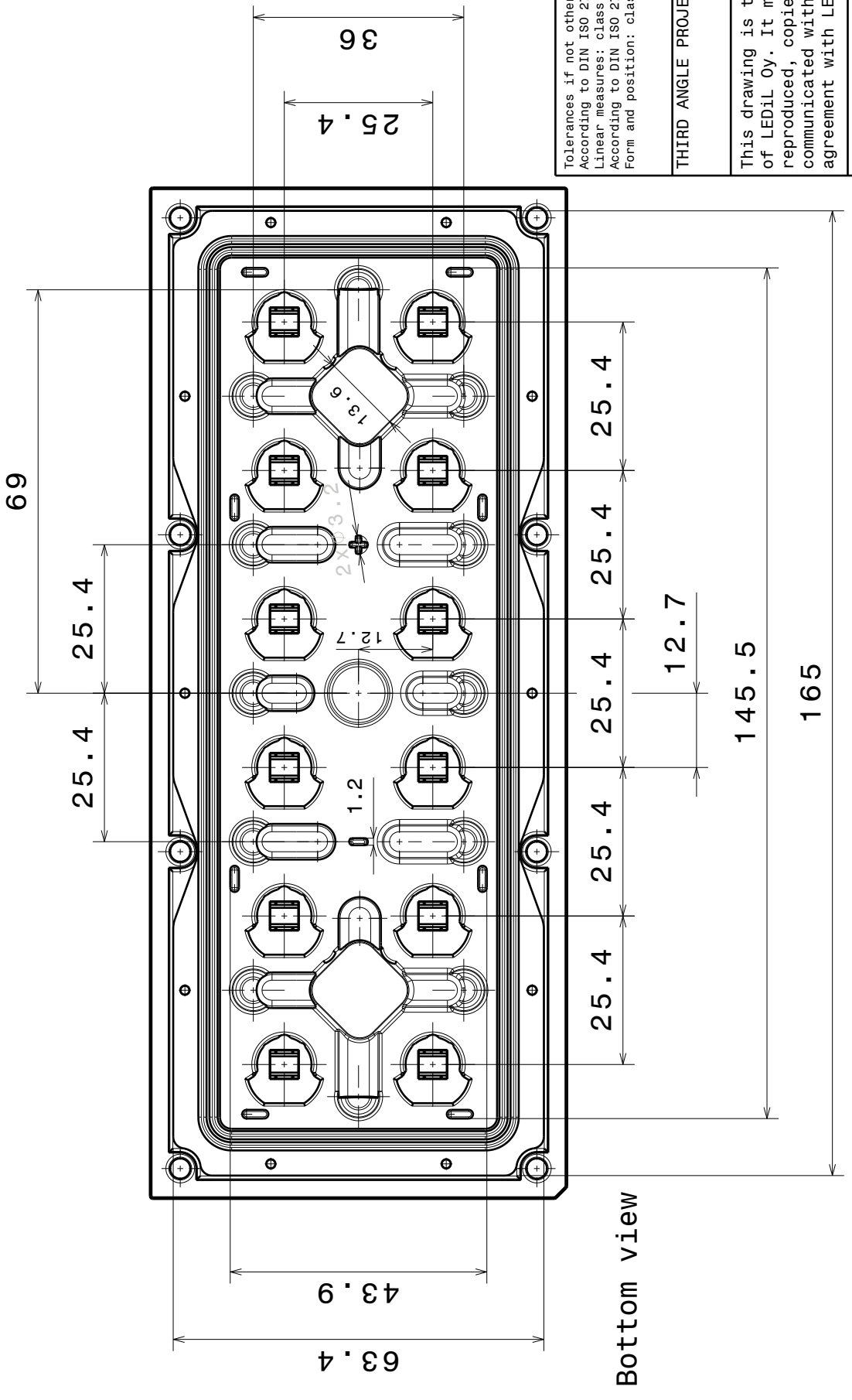

Bottom view

Section view B-B
Scale: 2:1

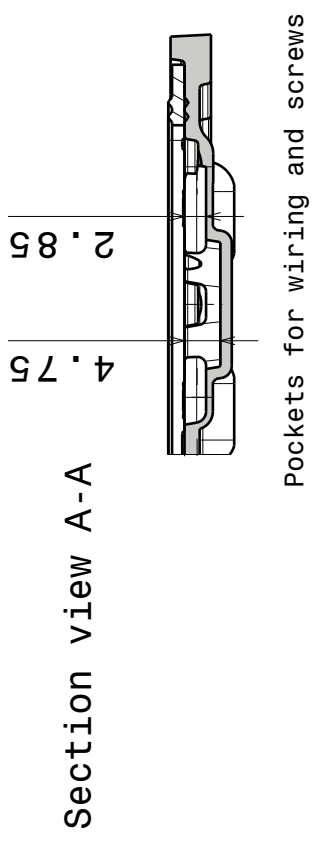
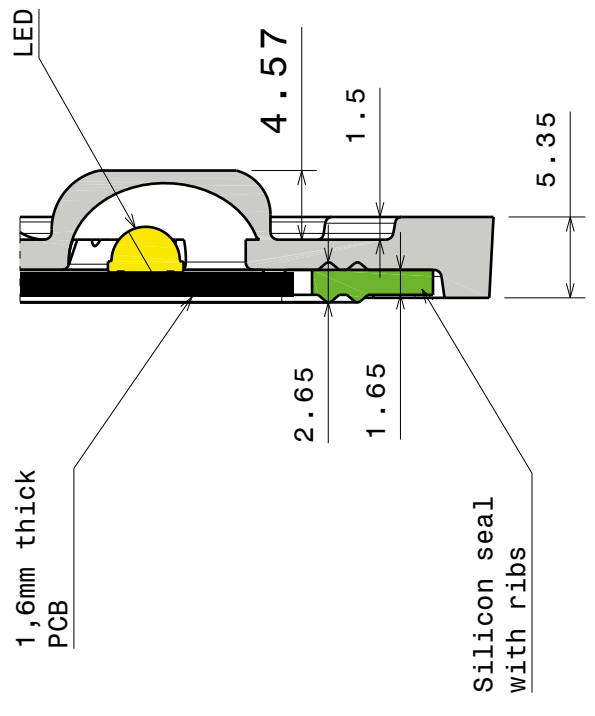

Section view A-A

INDEX	PART NO	DESCRIPTION	MATERIAL	COLOUR
1	C14018	2X6-SEAL25	Silicone	white
2	C13355	STRADA-IP-2X6-ME	PMMA	clear

Tolerances if not otherwise shown
According to DIN ISO 2768-1
Linear measures: class C
According to DIN ISO 2768-2
Form and position: class L

LEDIL
Ledil Oy
Salorankatu 10
FIN 24240 SALO
Finland

THIRD ANGLE PROJECTION:

DRAWING TITLE
CS14144_STRADA-IP-2X6-ME

SIZE PART NUMBER
A3 CS14144

SCALE 1:1 WEIGHT 53,58 g SHEET 1/2

Luminaire: LEDiL Oy CS14144_STRADA-IP-2X6-ME_(XT-E)_02 Eff.92.8%
Lamps: 1 x CREE_XT-E_6x2_(XTEAWT-00-0000-000000HE4)_1253.02lm@250mA_P=8.85391W_I=249.8mA

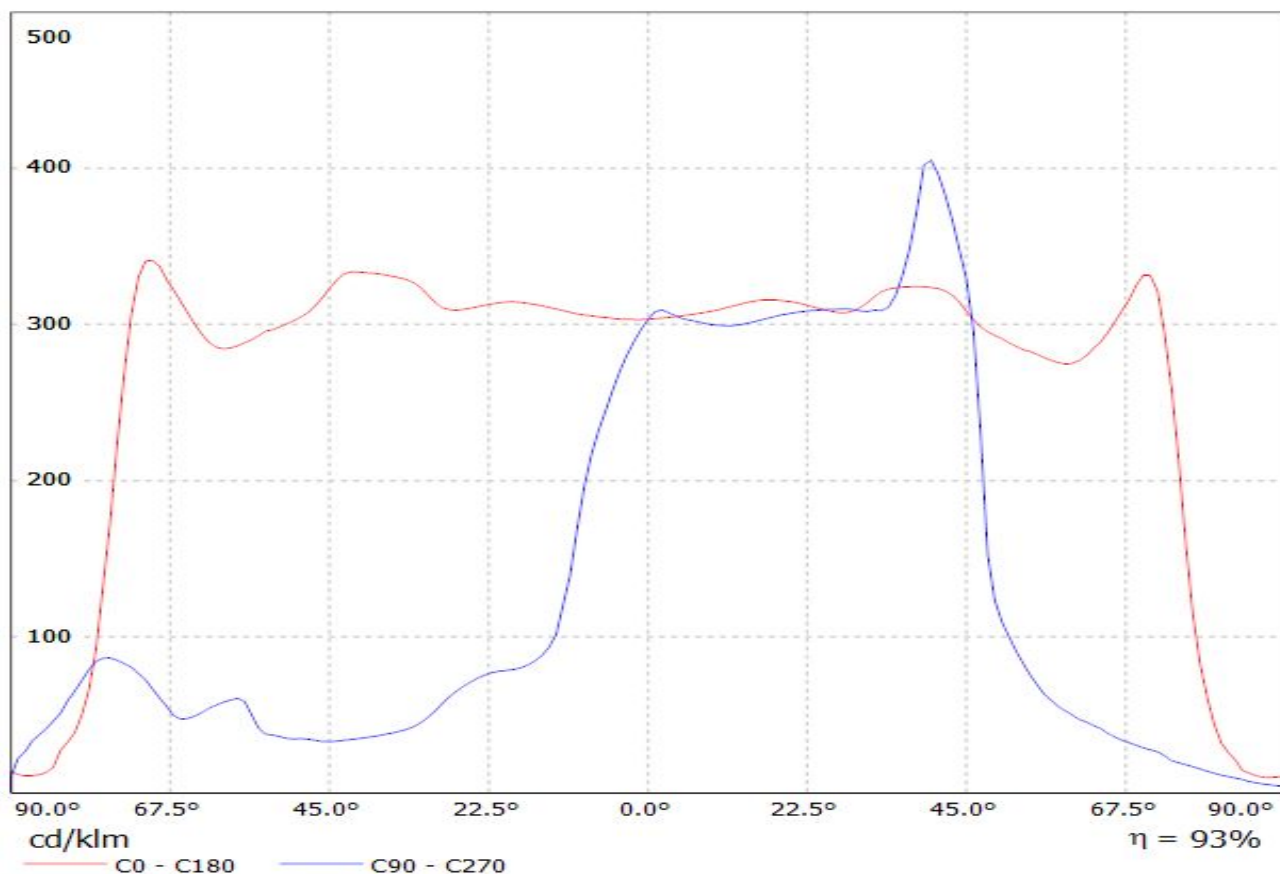

Luminaire: LEDiL Oy CS14144_STRADA-IP-2X6-ME_(XP-L)
Lamps: 1 x CREE_XP-L_2x6_(XPLAWT-0-7A3-U50-0H-0001)_1253.88lm@250mA_P=8.22317W_I=249.8mA

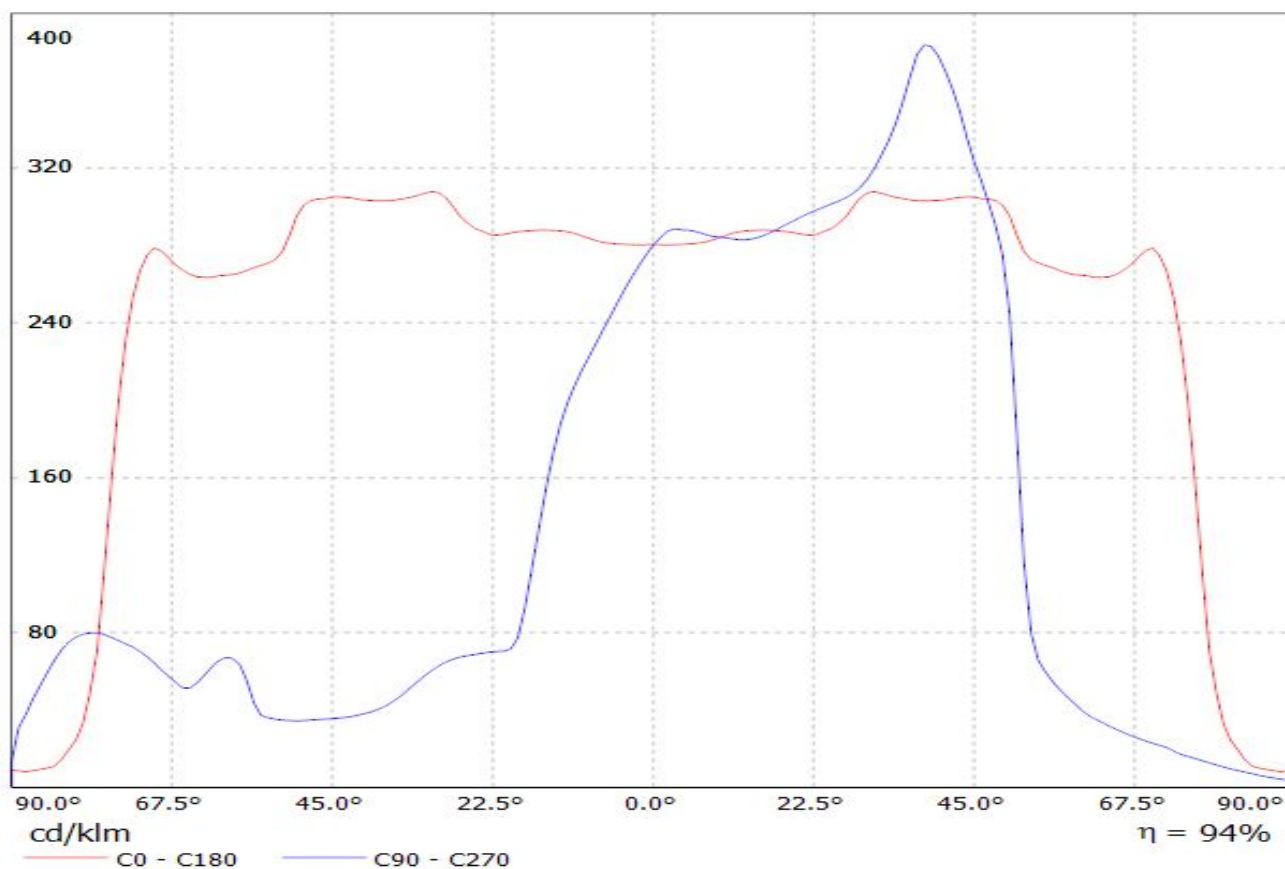

Luminaire: LEDiL Oy CS14144_STRADA-IP-2X6-ME_(XP-G2)
Lamps: 1 x XP-G2_2x6_1246.35lm@250mA_U=8.54391W_I=249.8mA

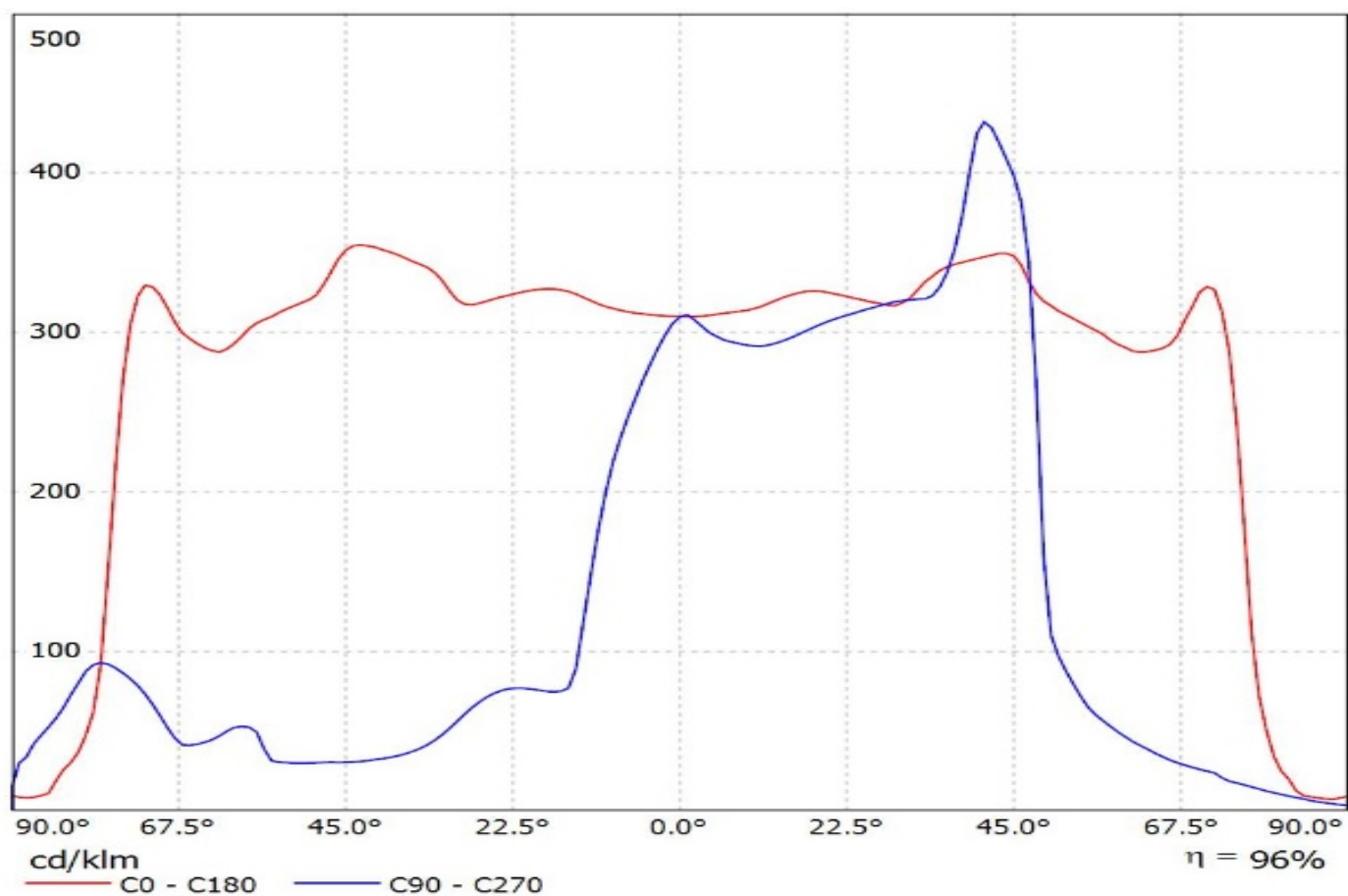

Luminaire: Ledil Oy CS14144_STRADA-IP-2X6-ME_(XP-G3)_SIMULATED
Lamps: 1 x Cree XP-G3

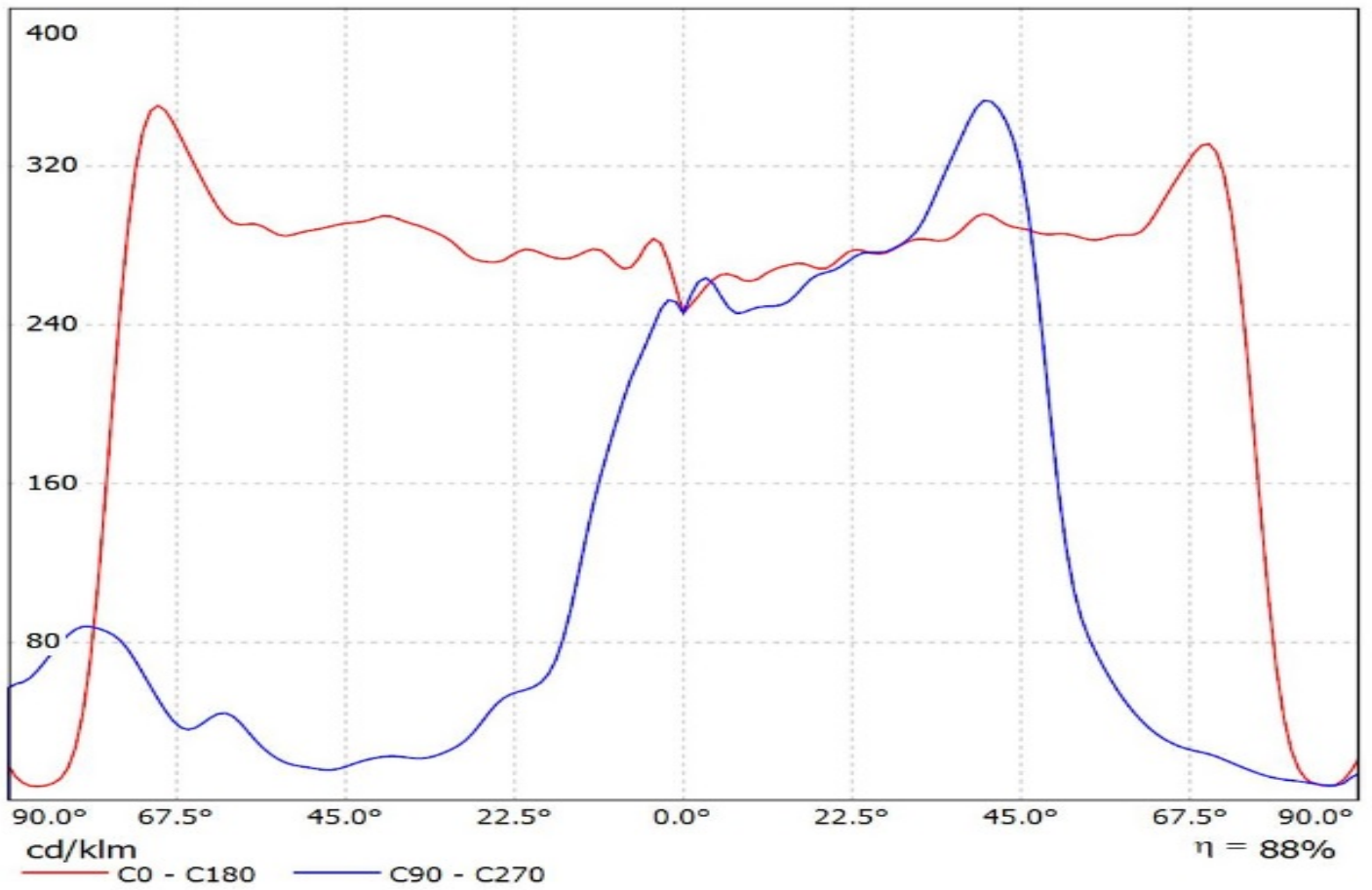

Luminaire: Ledil CS14144_STRADA-IP-2X6-ME_(XP-L2)
Lamps: 1 x Cree_XP-L2x12_(XPGBWT-H1-3B0-R5-0-01)
1666.32lm@250mA_CCT=5000_P=8.239W_I=0.25A

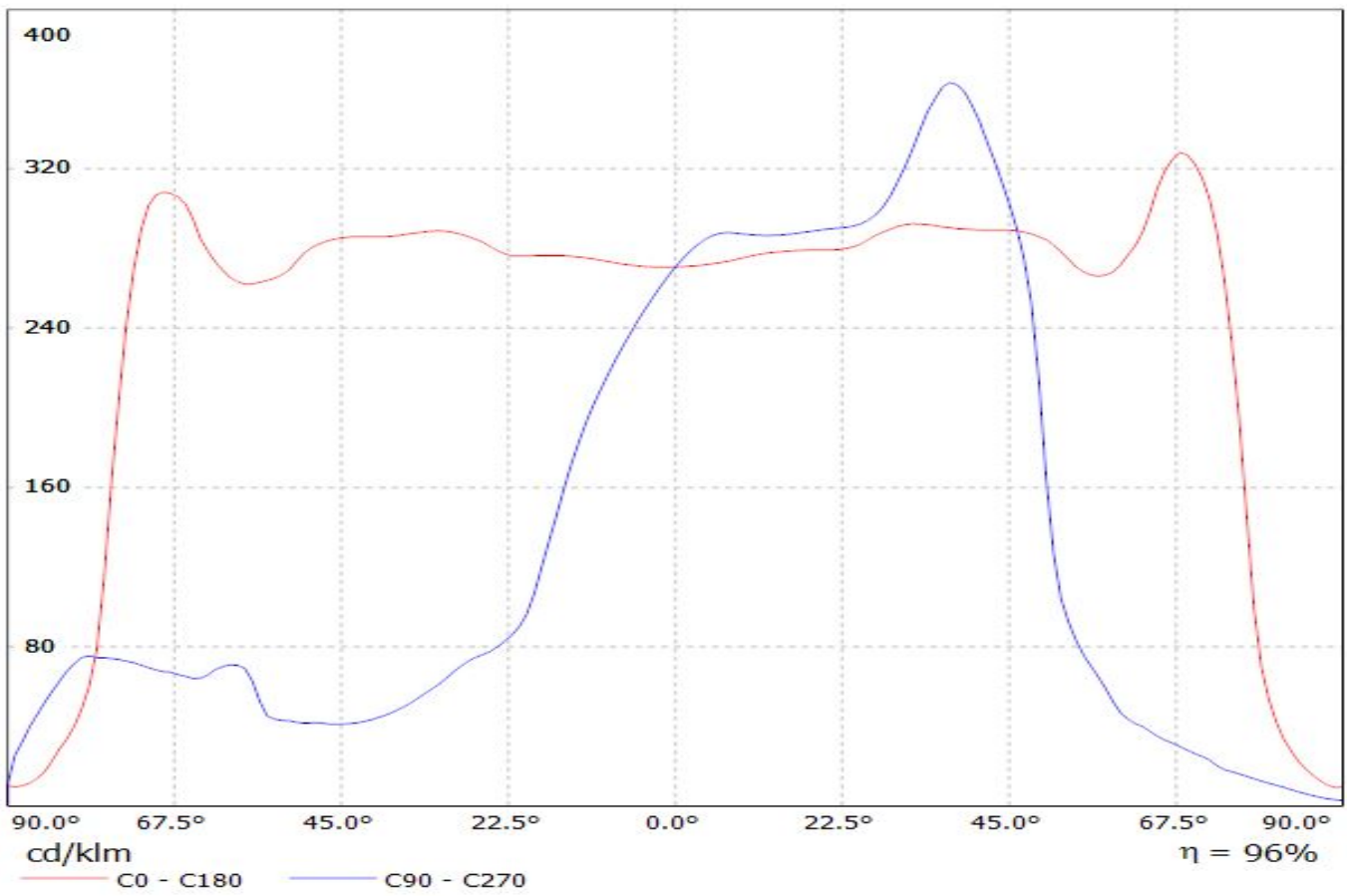

Luminaire: Ledil CS14144_STRADA-IP-2X6-ME_(H35C1)

Lamps: 1 x LG_H35C1_2x6_1389.53lm@250mA_CCT=5700_P=8.59425W_I=0.250A

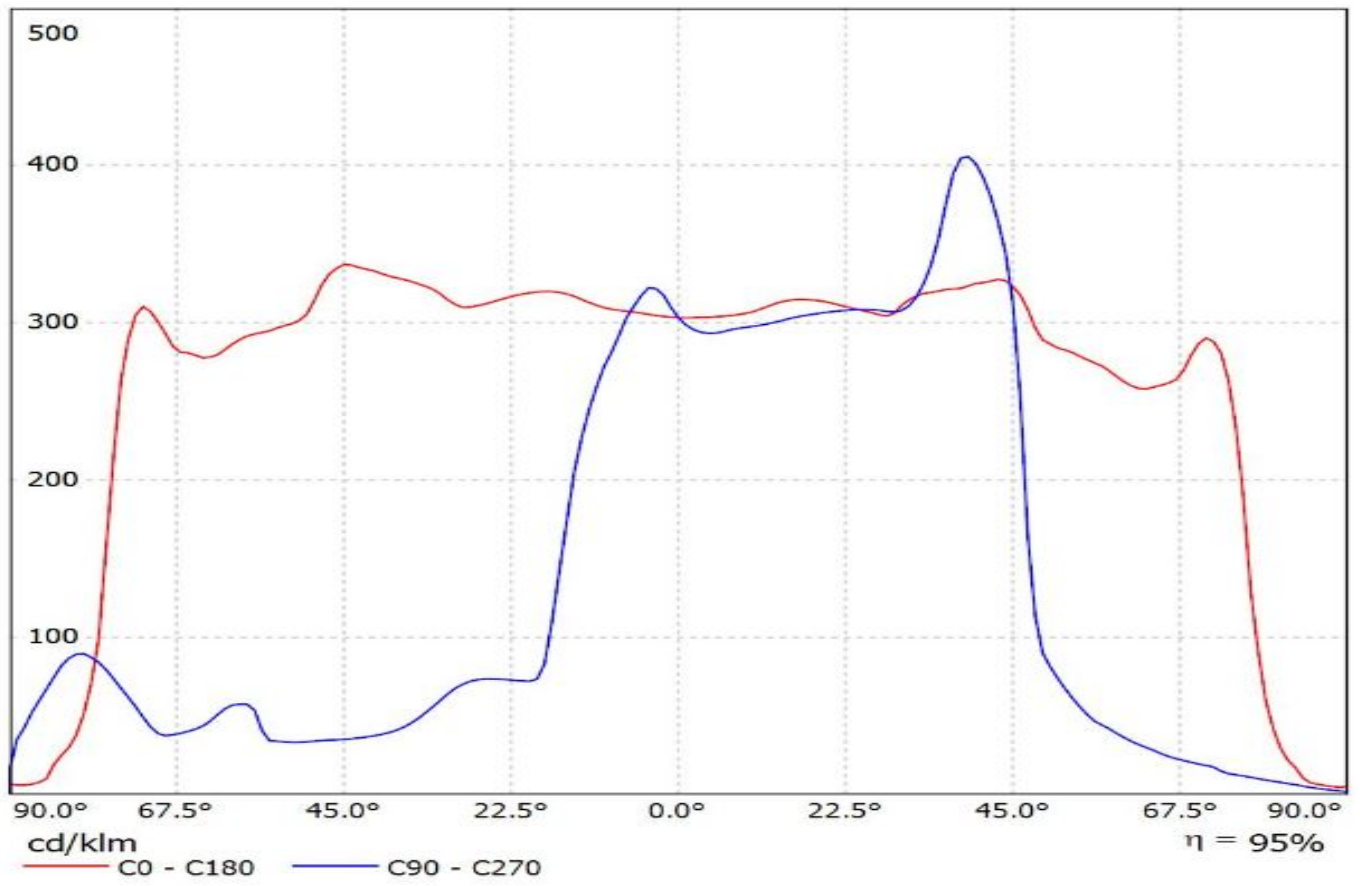

Luminaire: Ledil CS14144_STRADA-IP-2X6-ME_(XR-TX)
Lamps: 1 x Luxeon_XR-TX_1377.67lm@250mA_P=8.3973W_I=0.250A

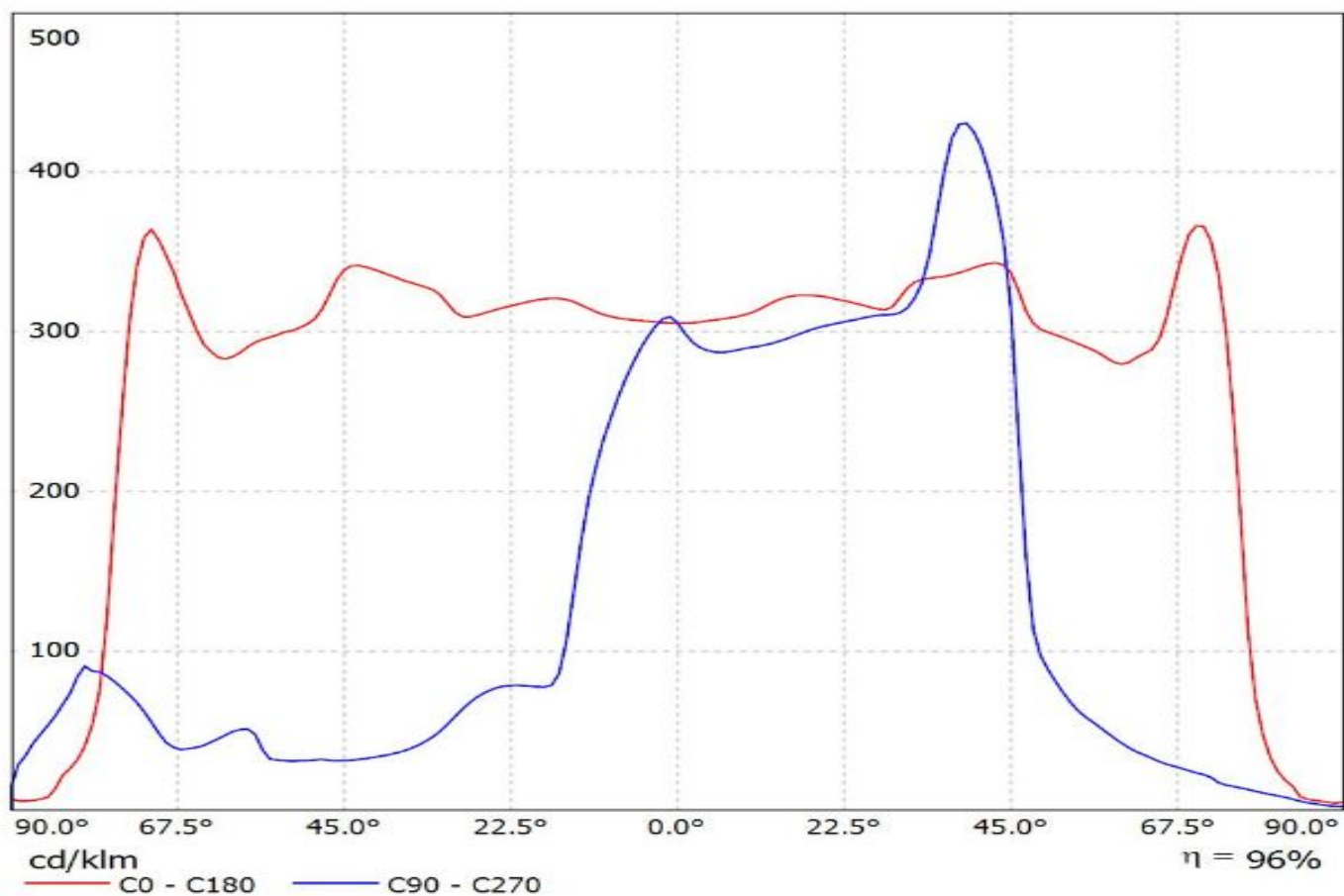

Luminaire: Ledil CS14144_STRADA-IP-2X6-ME_(NVSL219CT)
Lamps: 1 x Nichia_NVSL219CT_2x6_1262.53lm@250mA_P=8.35825W_I=0.25A

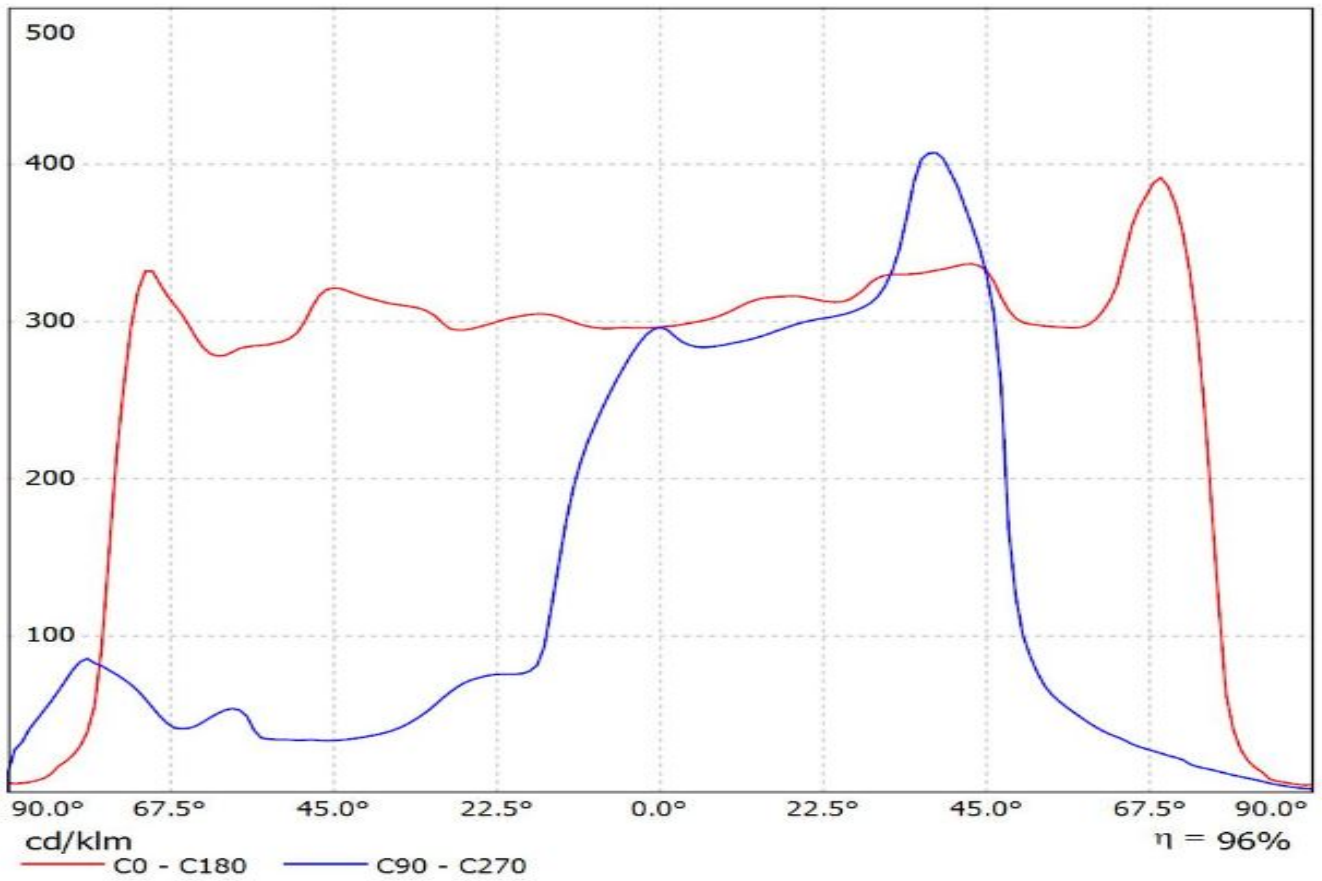

Luminaire: Ledil Oy CS14144_STRADA-IP-2X6-ME_(Duris_P8)_SIMULATED
Lamps: 1 x Osram Duris P8

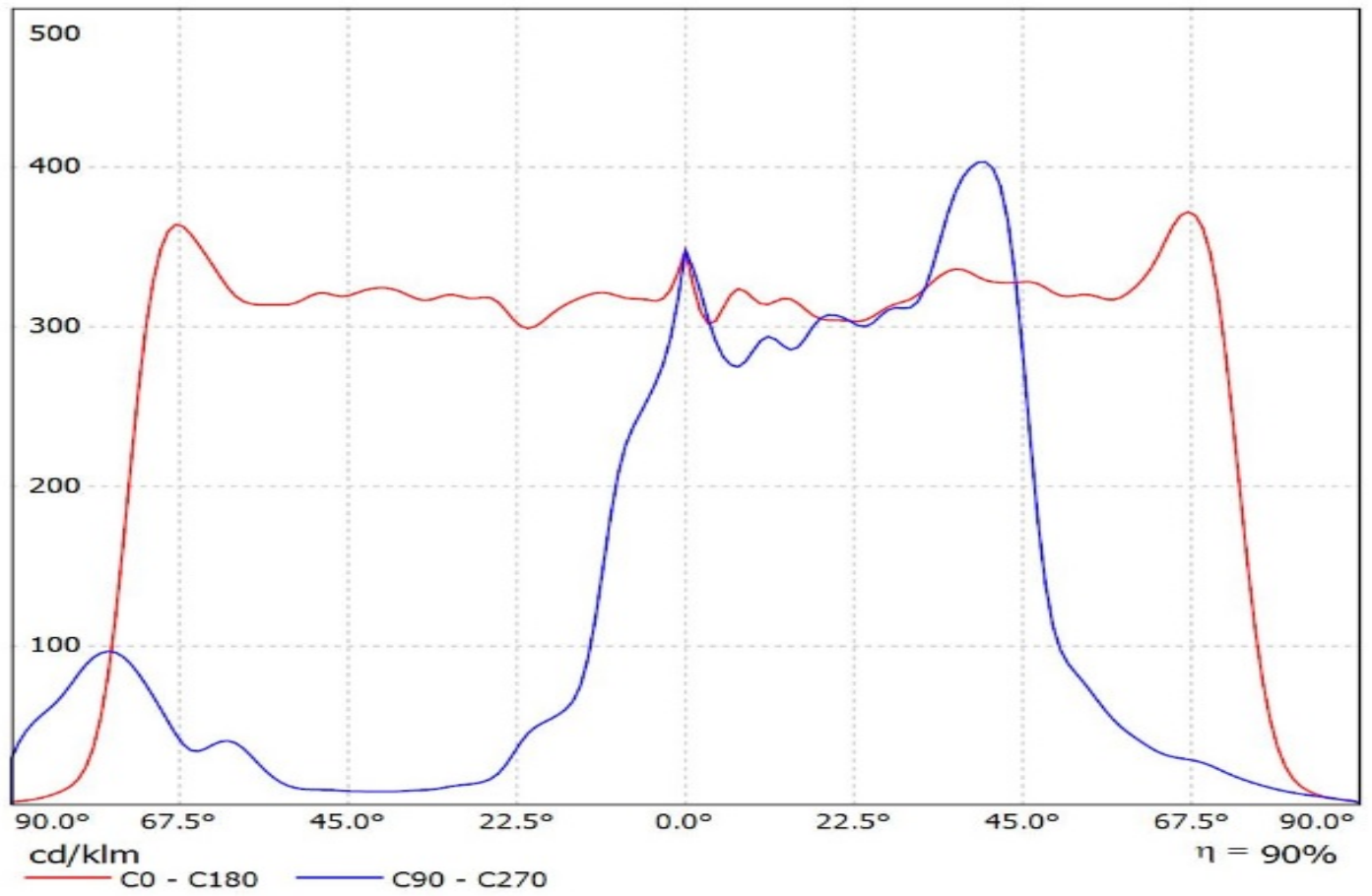

Luminaire: Ledil Oy CS14144_STRADA-IP-2X6-ME_(Z5M1)_SIMULATED
Lamps: 1 x Seoul Z5M1

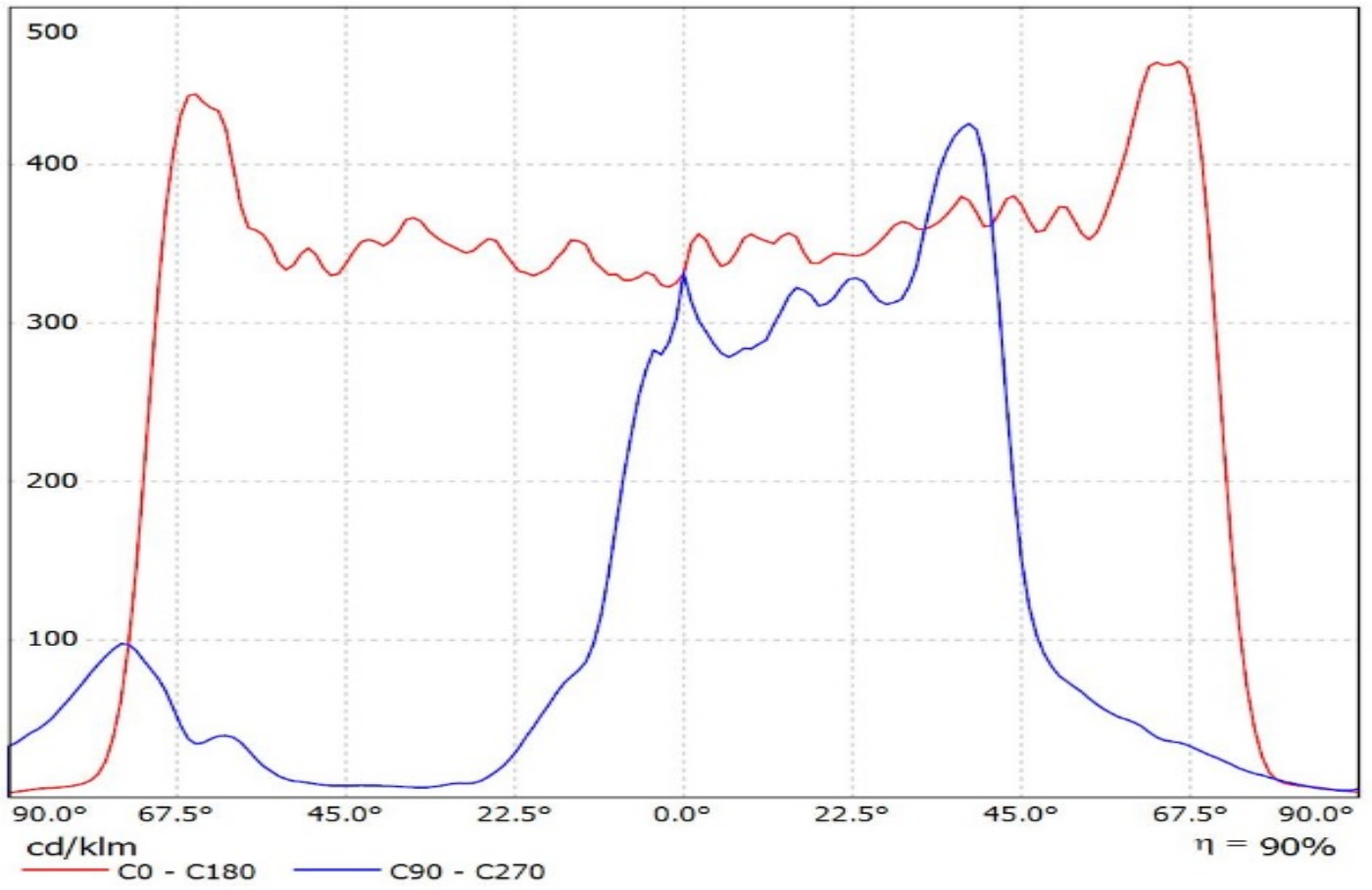

Luminaire: Ledil CS14144_STRADA-IP-2X6-ME_(Z8Y22_PLUS)

Lamps: 1 x Seoul_Z8Y22_PLUS_2X6_(SZ8-Y22-W0-C7P)1489.65lm@250mA_P=8.30675W_I=0.250A

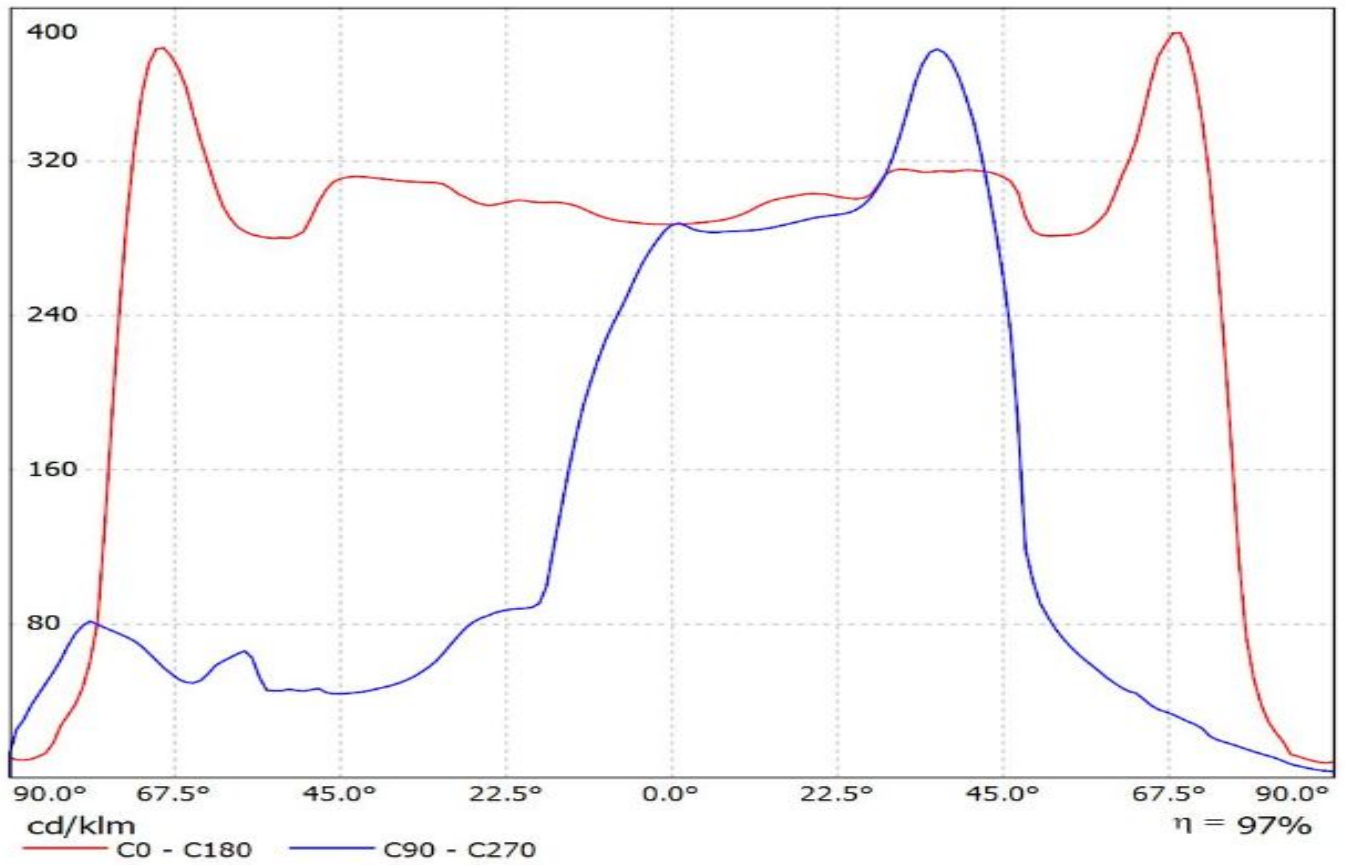

Ledil CS14144_STRADA-IP-2X6-ME_(TL1L4) / LDC (Linear)

Luminaire: Ledil CS14144_STRADA-IP-2X6-ME_(TL1L4)

Lamps: 1 x Toshiba_TL1L4_2x6_(TL1L4-DW0)_1346.96lm@250mA_CCT=6500K_P=8.5W_I=0.25A

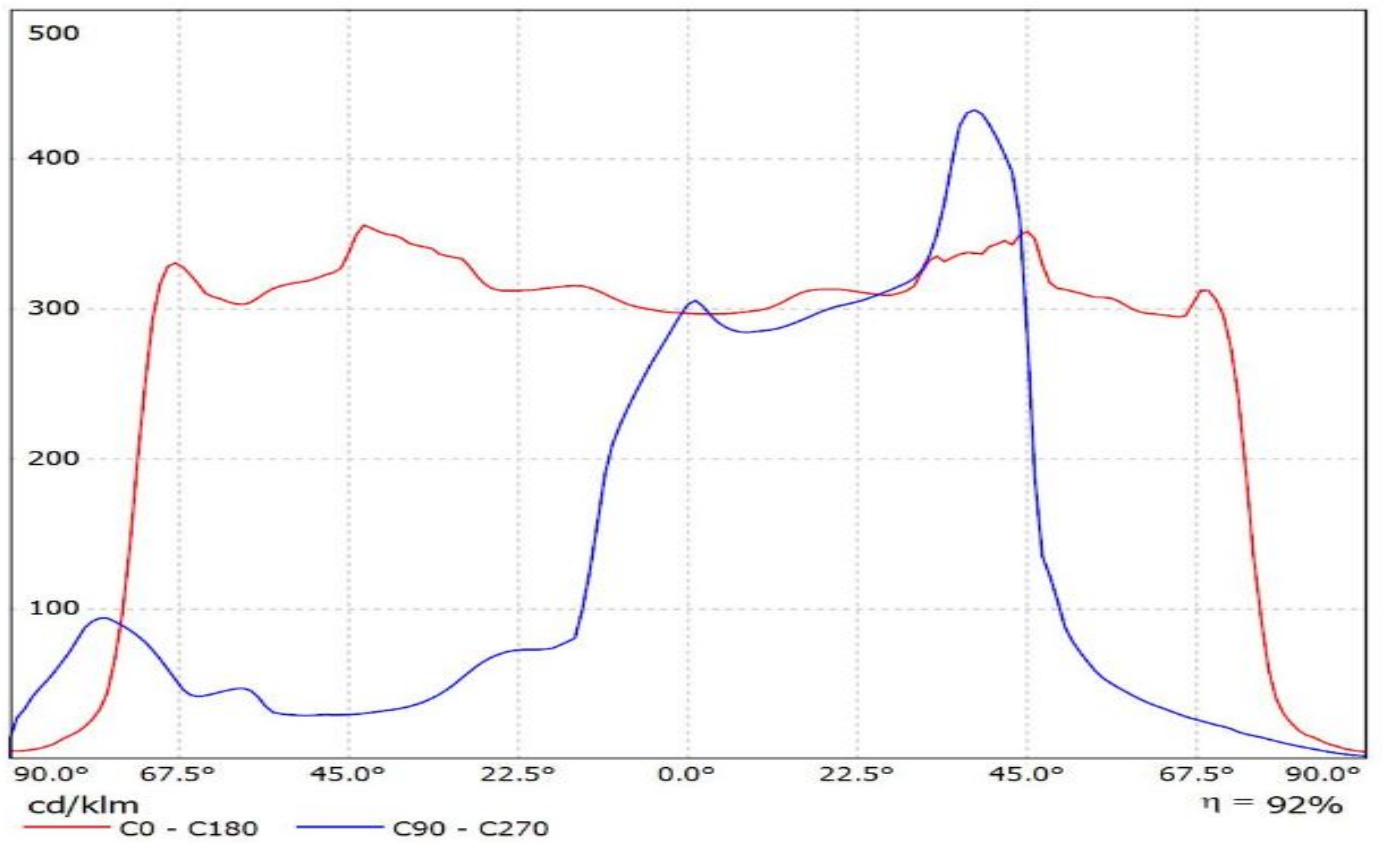

Luminaire: LEDiL Oy CS14144_STRADA-IP-2X6-ME_(XT-E)_02 Eff.92.8%

Lamps: 1 x CREE_XT-E_6x2_(XTEAWT-00-0000-000000HE4)_1253.02lm@250mA_P=8.85391W_I=249.8mA

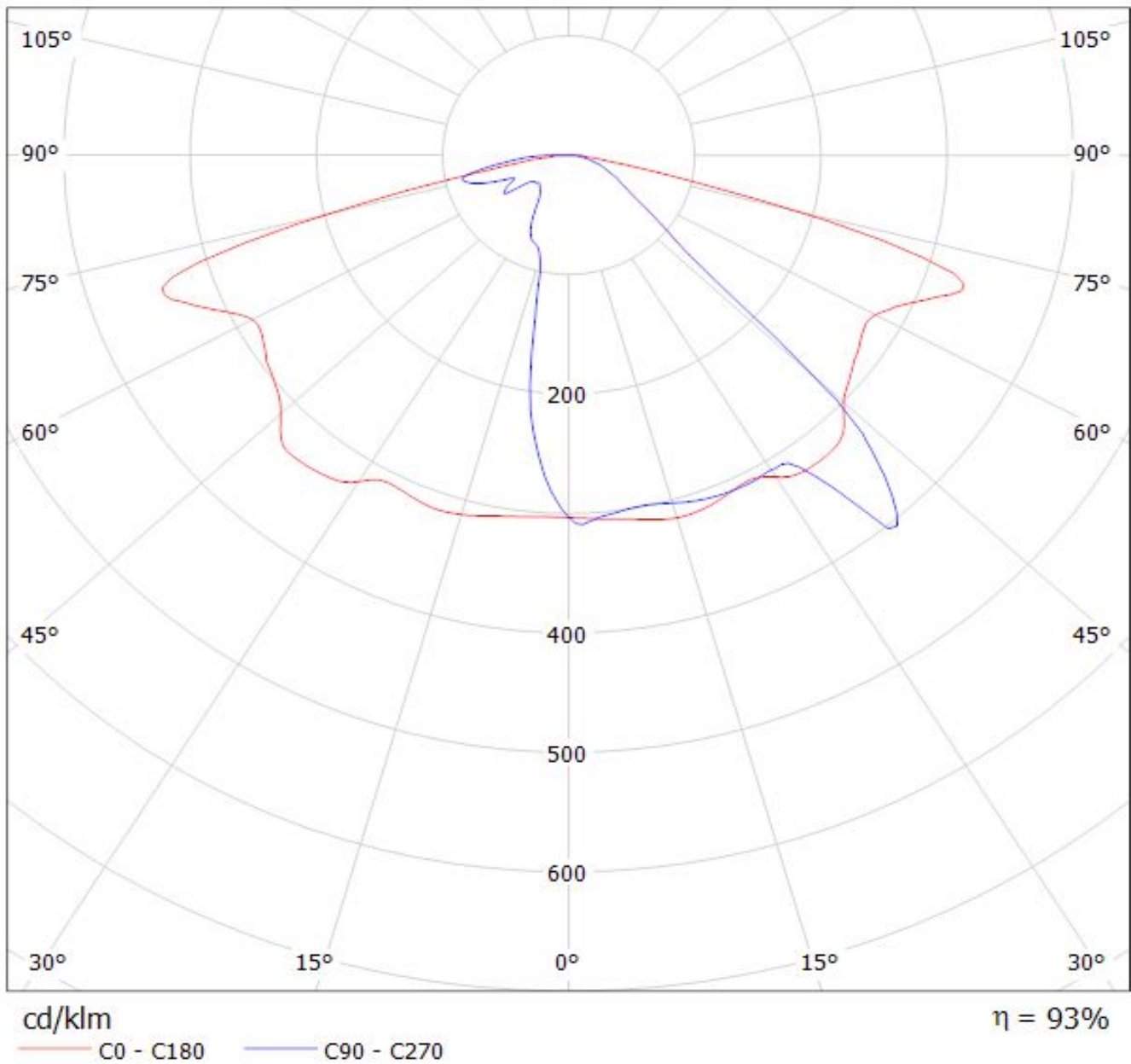

Luminaire: LEDiL Oy CS14144_STRADA-IP-2X6-ME_(XP-L)

Lamps: 1 x CREE_XP-L_2x6_(XPLAWT-0-7A3-U50-0H-0001)_1253.88lm@250mA_P=8.22317W_I=249.8mA

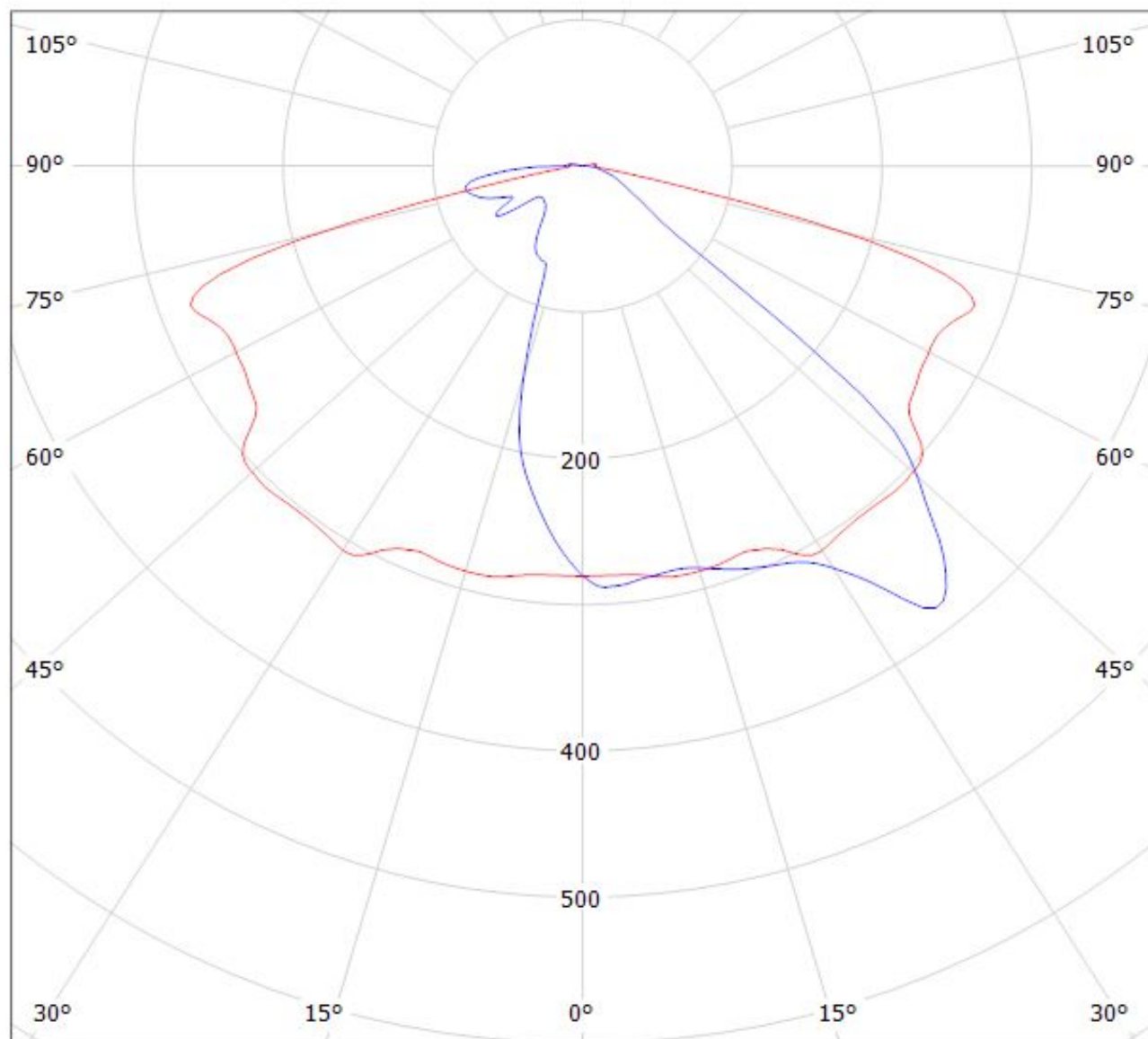

cd/klm

— C0 - C180

— C90 - C270

$\eta = 94\%$

Luminaire: LEDiL Oy CS14144_STRADA-IP-2X6-ME_(XP-G2)
Lamps: 1 x XP-G2_2x6_1246.35lm@250mA_U=8.54391W_I=249.8mA

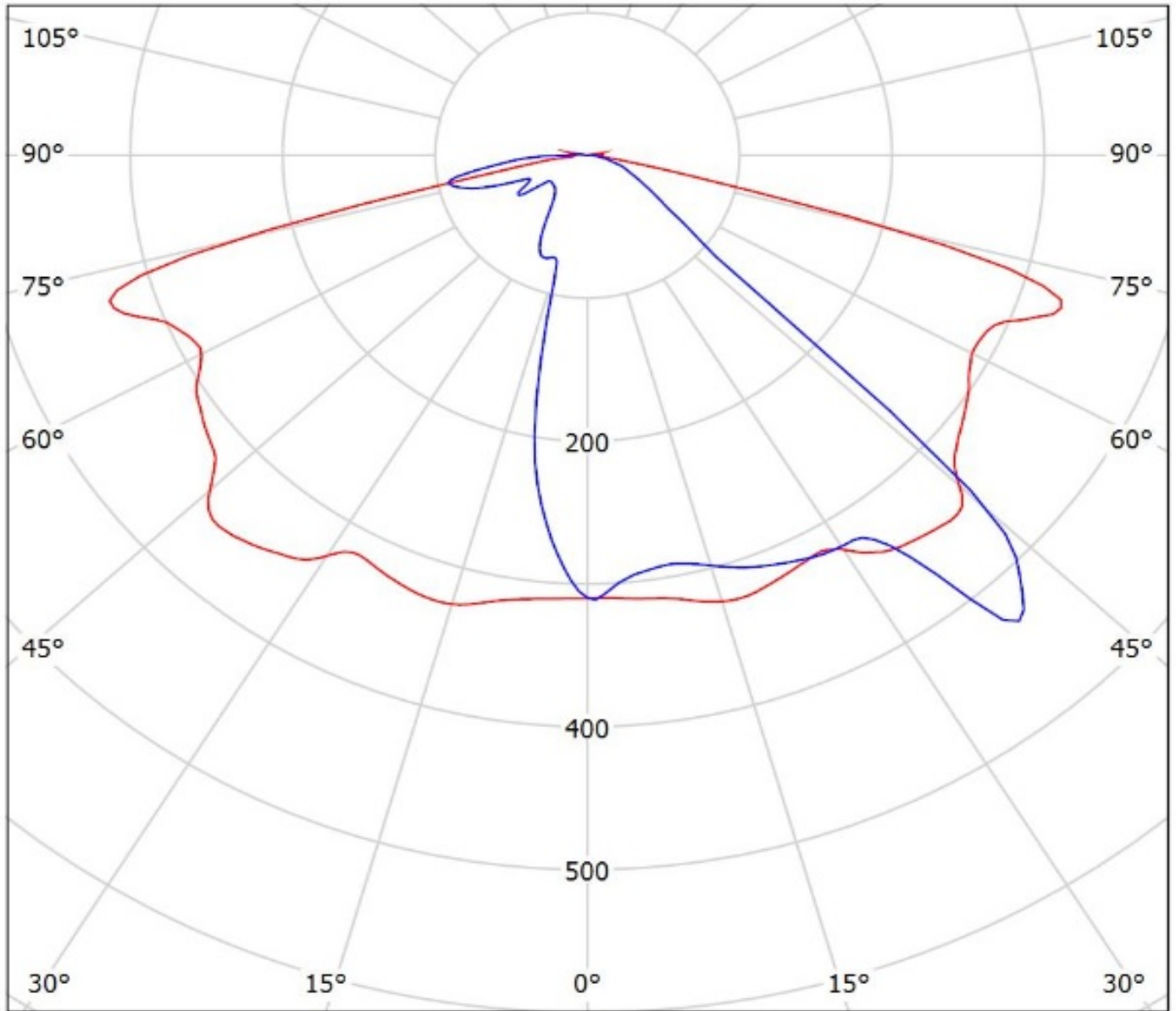

cd/klm

— C0 - C180 — C90 - C270

$\eta = 96\%$

Luminaire: Ledil Oy CS14144_STRADA-IP-2X6-ME_(XP-G3)_SIMULATED
Lamps: 1 x Cree XP-G3

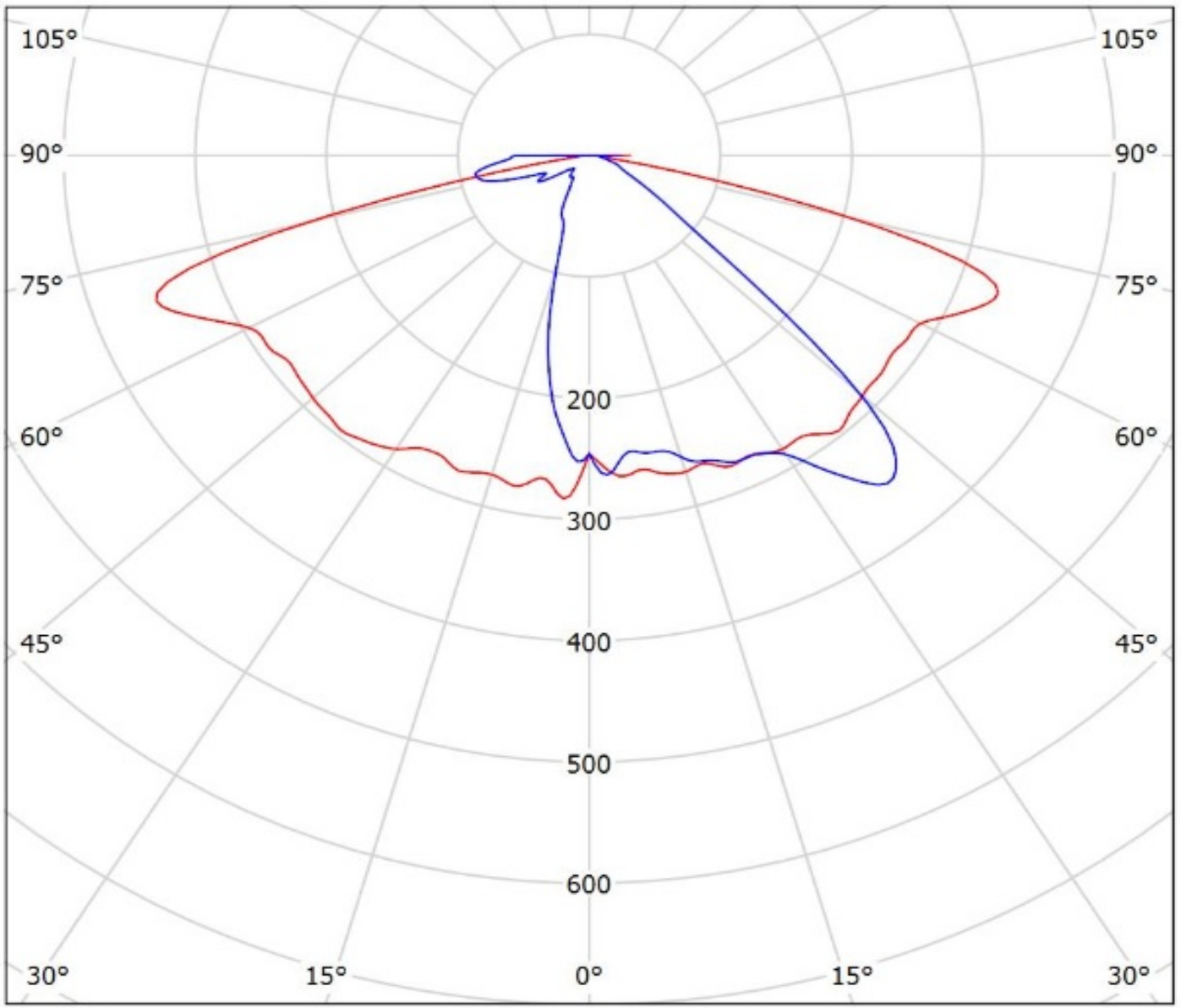

cd/klm

— C0 - C180 — C90 - C270

$\eta = 88\%$

Luminaire: Ledil CS14144_STRADA-IP-2X6-ME_(XP-L2)
Lamps: 1 x Cree_XP-L2x12_(XPGBWT-H1-3B0-R5-0-01)
1666.32lm@250mA_CCT=5000_P=8.239W_I=0.25A

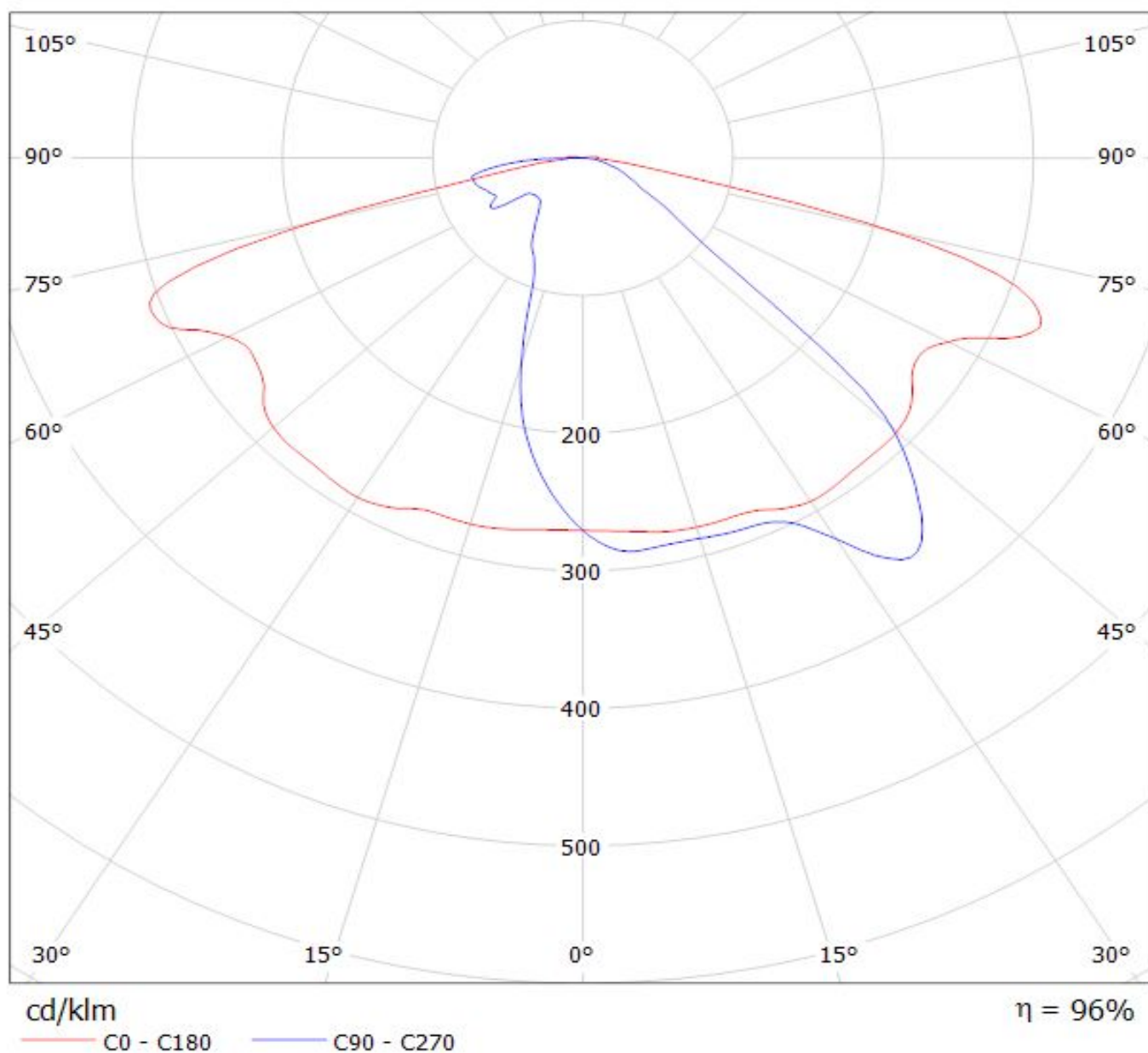

Luminaire: Ledil CS14144_STRADA-IP-2X6-ME_(H35C1)
Lamps: 1 x LG_H35C1_2x6_1389.53lm@250mA_CCT=5700_P=8.59425W_I=0.250A

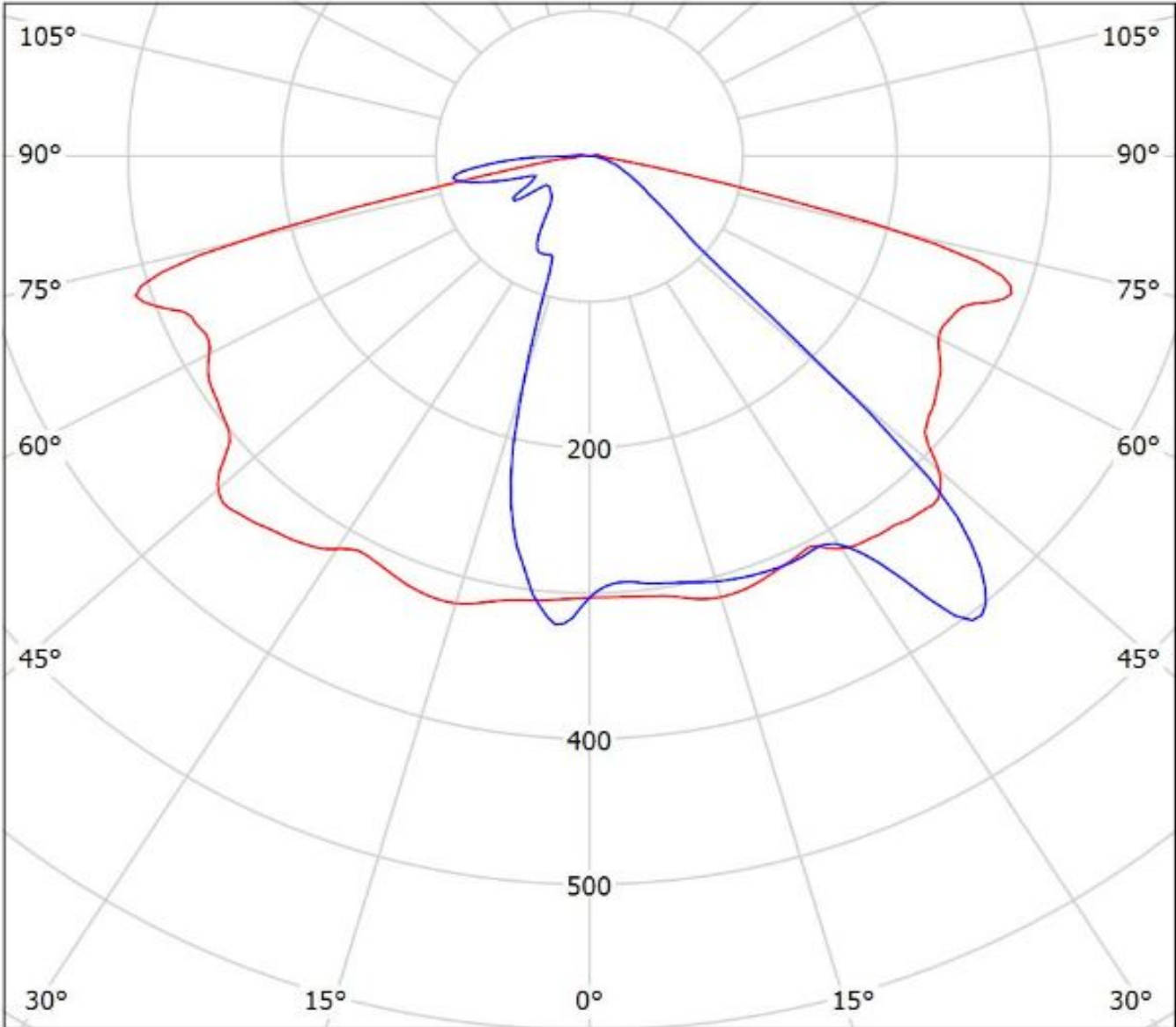

cd/klm
— C0 - C180 — C90 - C270

$\eta = 95\%$

Luminaire: Ledil CS14144_STRADA-IP-2X6-ME_(XR-TX)
Lamps: 1 x Luxeon_XR-TX_1377.67lm@250mA_P=8.3973W_I=0.250A

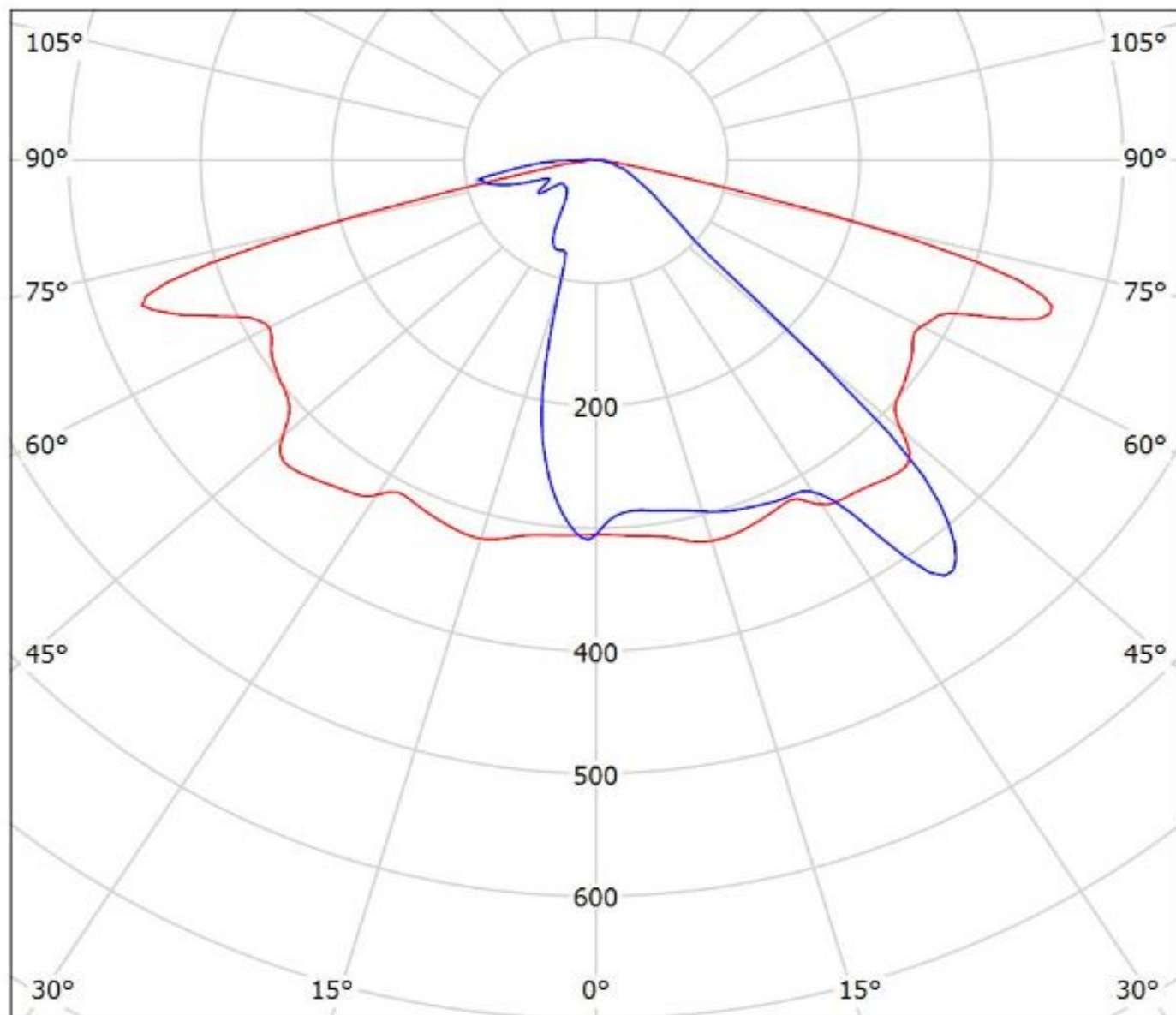

cd/klm
— C0 - C180 — C90 - C270

$\eta = 96\%$

Luminaire: Ledil CS14144_STRADA-IP-2X6-ME_(NVSL219CT)
Lamps: 1 x Nichia_NVSL219CT_2x6_1262.53lm@250mA_P=8.35825W_I=0.25A

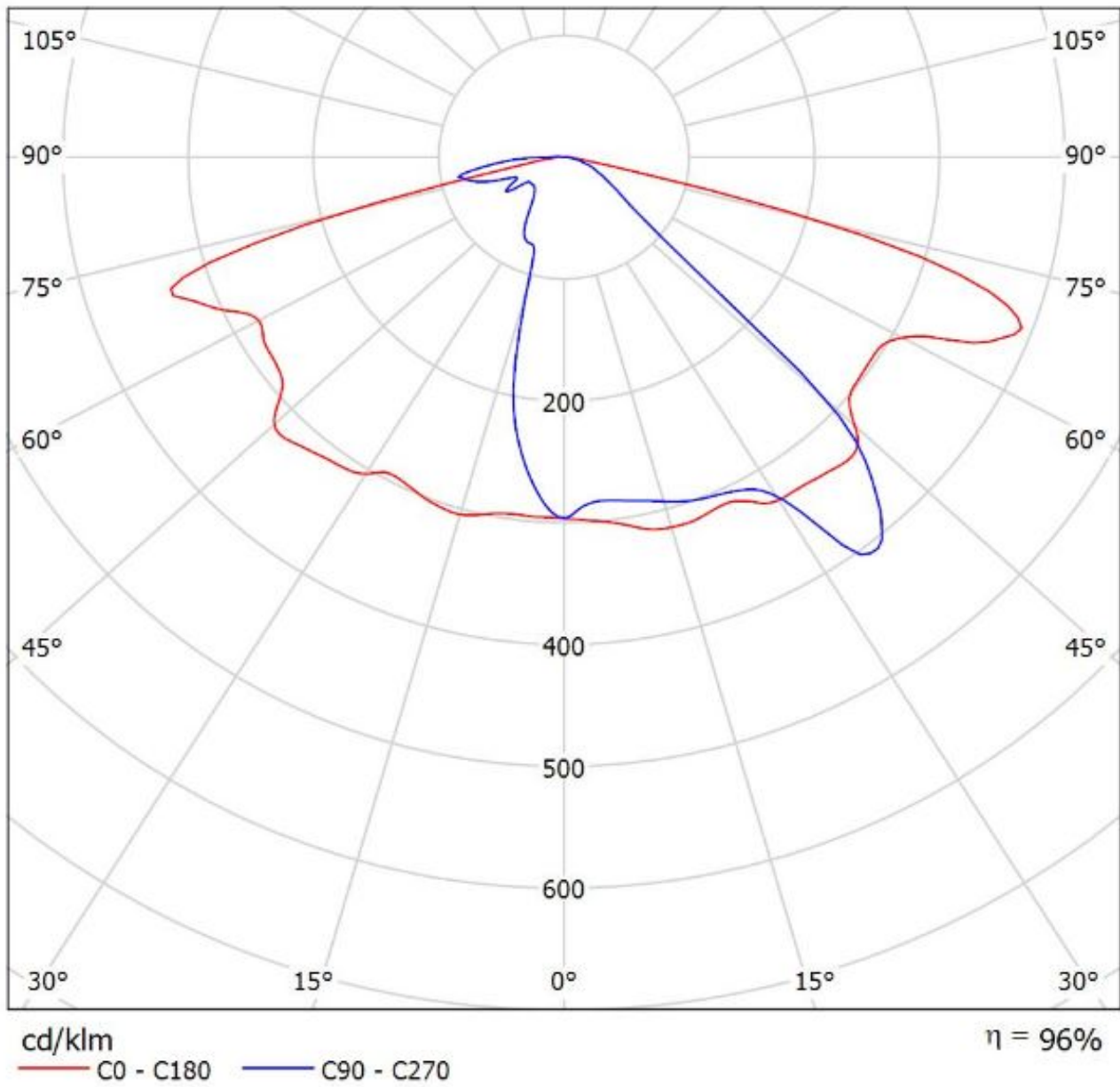

Luminaire: Ledil Oy CS14144_STRADA-IP-2X6-ME_(Duris_P8)_SIMULATED
Lamps: 1 x Osram Duris P8

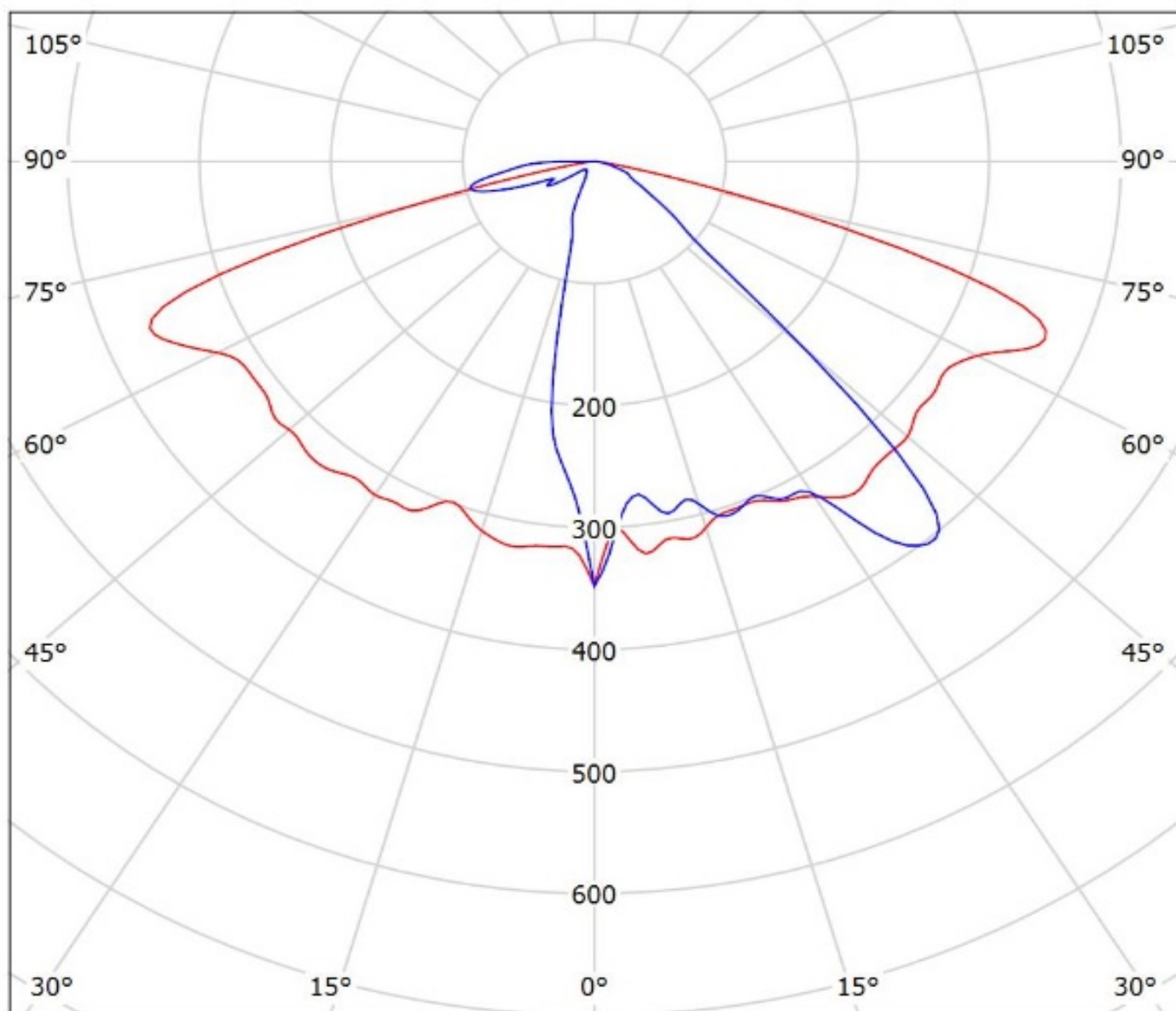

cd/klm

— C0 - C180 — C90 - C270

$\eta = 90\%$

Luminaire: Ledil Oy CS14144_STRADA-IP-2X6-ME_(Z5M1)_SIMULATED
Lamps: 1 x Seoul Z5M1

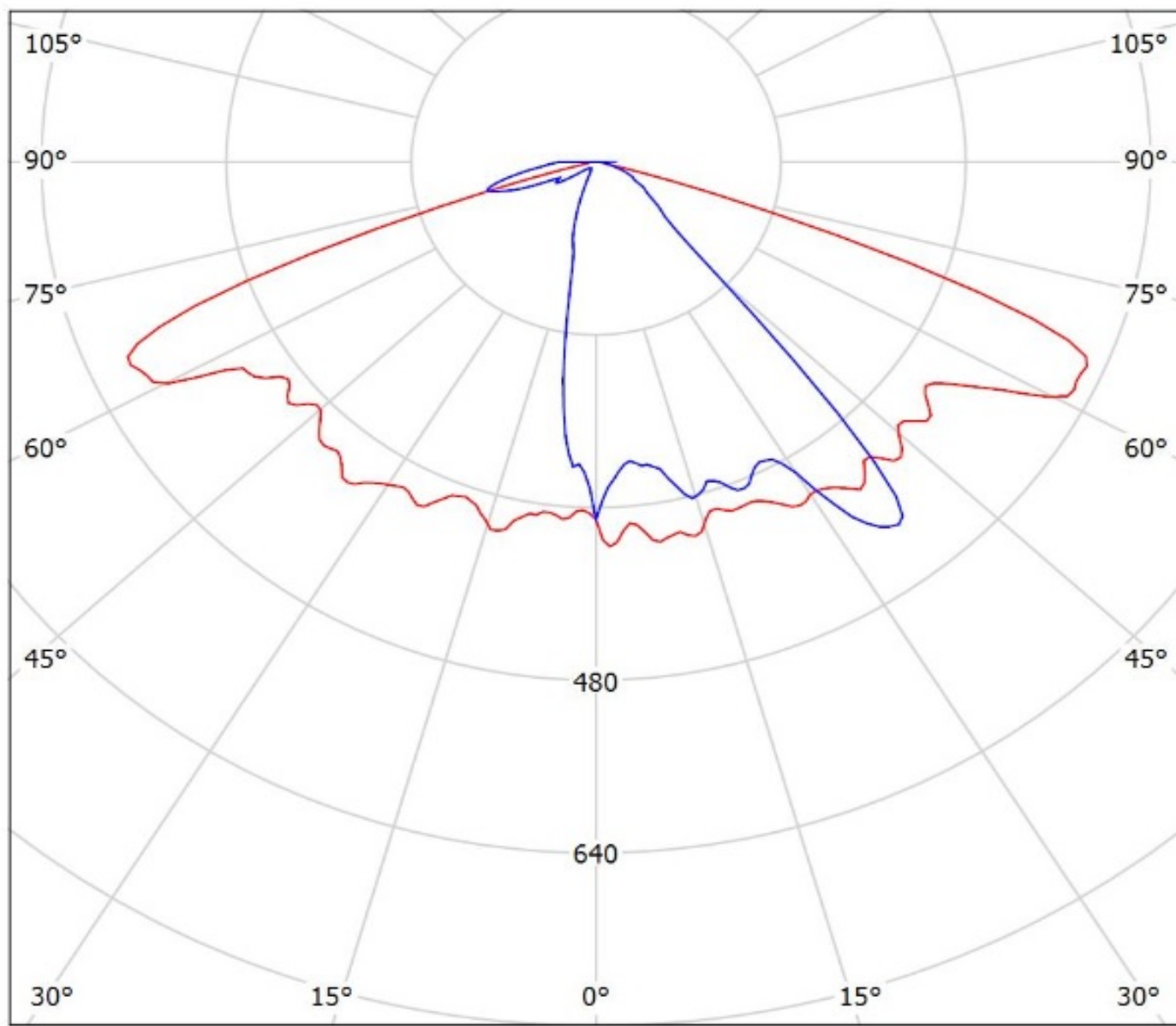

cd/klm
— C0 - C180 — C90 - C270

$\eta = 90\%$

Luminaire: Ledil CS14144_STRADA-IP-2X6-ME_(Z8Y22_PLUS)

Lamps: 1 x Seoul_Z8Y22_PLUS_2X6_(SZ8-Y22-W0-C7P)1489.65lm@250mA_P=8.30675W_I=0.250A

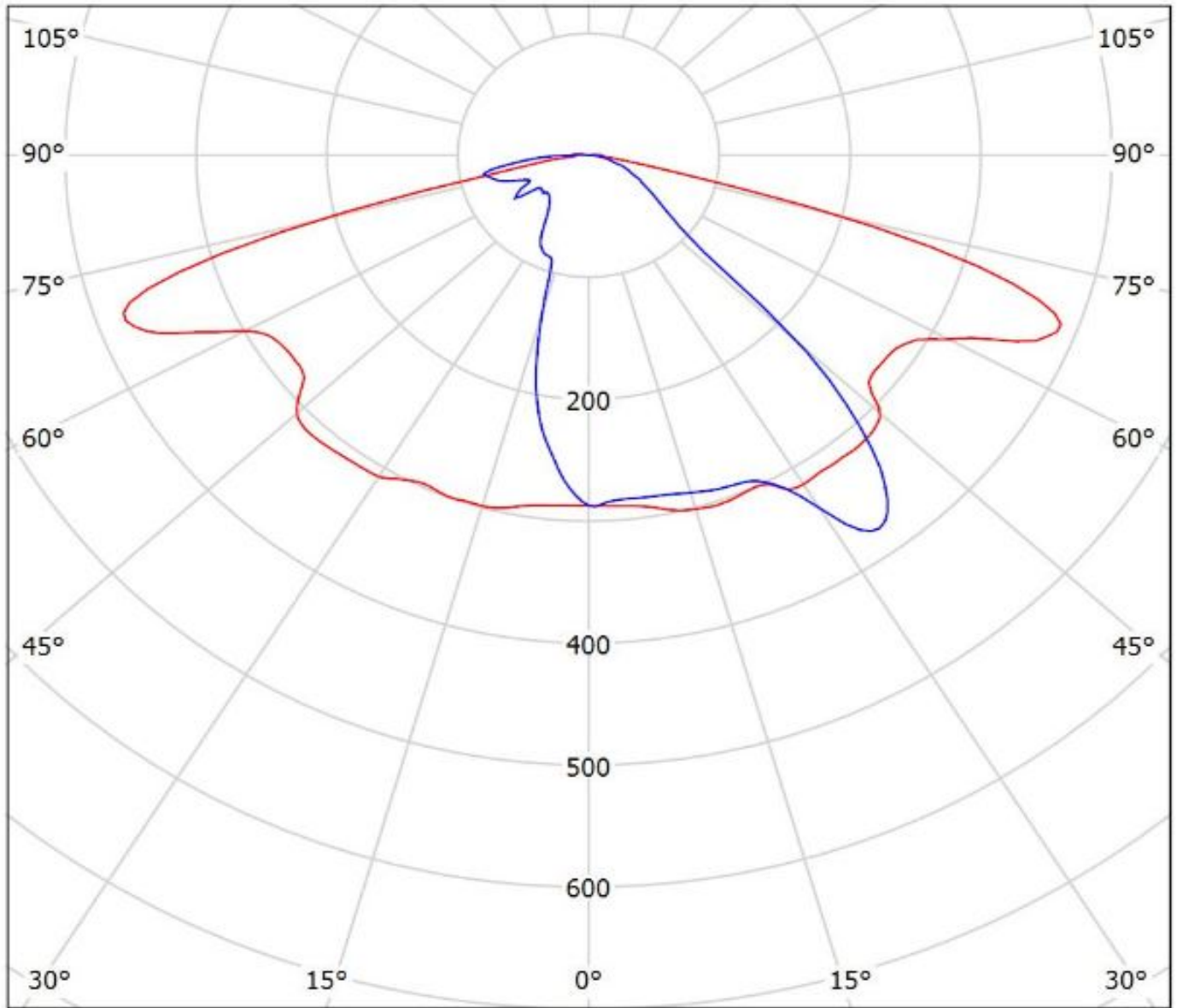

cd/klm

— C0 - C180 — C90 - C270

$\eta = 97\%$

Ledil CS14144_STRADA-IP-2X6-ME_(TL1L4) / LDC (Polar)

Luminaire: Ledil CS14144_STRADA-IP-2X6-ME_(TL1L4)

Lamps: 1 x Toshiba_TL1L4_2x6_(TL1L4-DW0)_1346.96lm@250mA_CCT=6500K_P=8.5W_I=0.25A

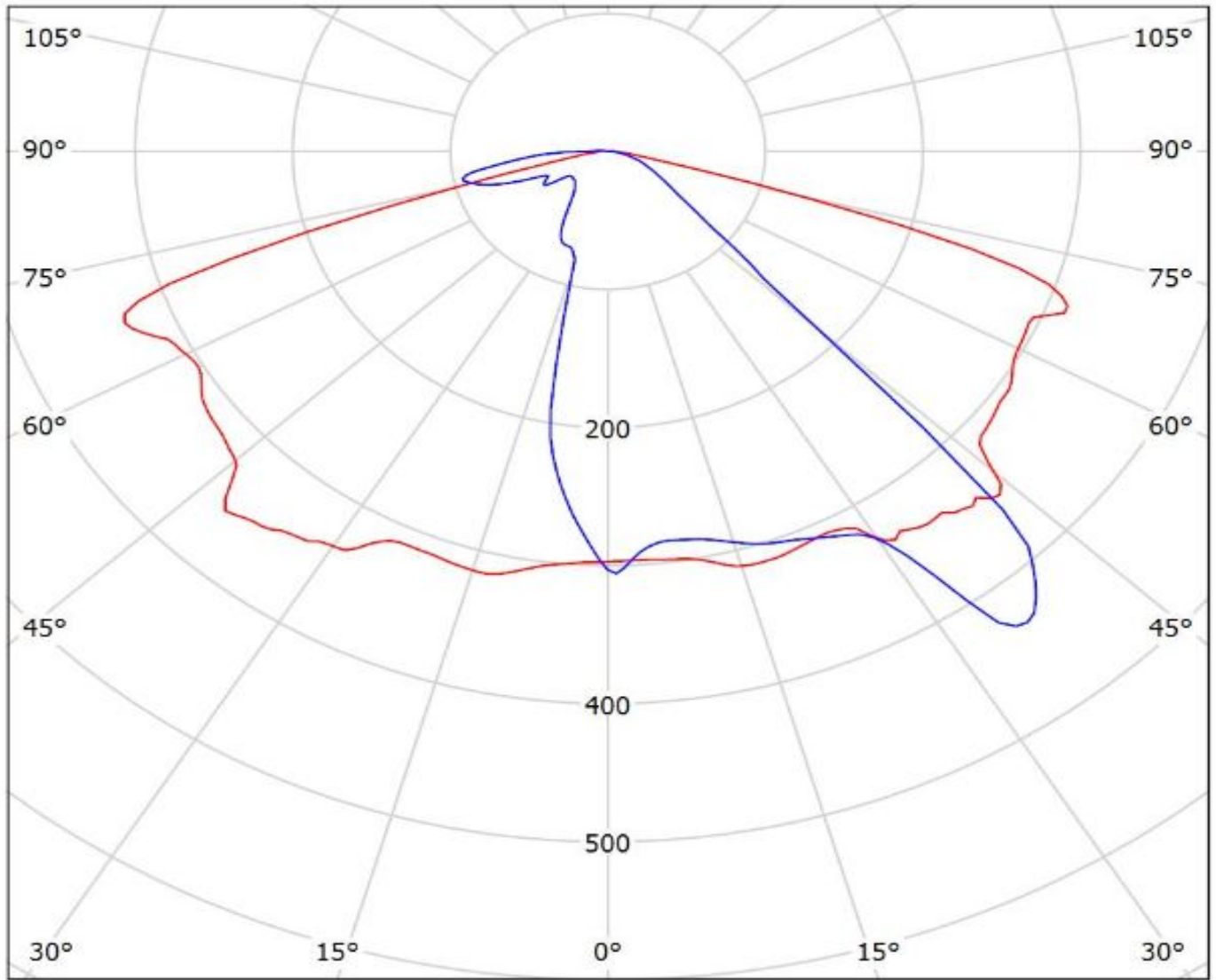

cd/klm

— C0 - C180 — C90 - C270

$\eta = 92\%$

NOTE: The typical divergence will be changed by different color, chip size and chip position tolerance. The typical total divergence is the full angle measured where the luminous intensity is half of the peak value.