

General Description

- Trench Power AlphaSGT™ technology
- Low $R_{DS(ON)}$
- RoHS and Halogen Free Compliant

Applications

- Synchronous Rectification for power supply
- Ideal for boost converters

Product Summary

V_{DS}	100V
I_D (at $V_{GS}=10V$)	105A
$R_{DS(ON)}$ (at $V_{GS}=10V$)	< 4.5mΩ (< 4.1mΩ*)
$R_{DS(ON)}$ (at $V_{GS}=6V$)	< 5.3mΩ (< 4.9mΩ*)

100% UIS Tested
 100% Rg Tested

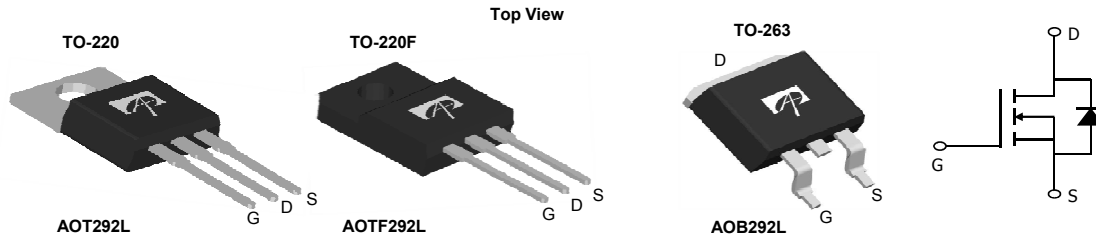

Orderable Part Number	Package Type	Form	Minimum Order Quantity
AOT292L	TO-220	Tube	1000
AOTF292L	TO-220F	Tube	1000
AOB292L	TO-263	Tape & Reel	800

Absolute Maximum Ratings $T_A=25^\circ\text{C}$ unless otherwise noted

Parameter	Symbol	AOT(B)292L	AOTF292L	Units
Drain-Source Voltage	V_{DS}	100		V
Gate-Source Voltage	V_{GS}	±20		V
Continuous Drain Current I_D^{G**}	$T_C=25^\circ\text{C}$	105	70	A
	$T_C=100^\circ\text{C}$	82	50	
Pulsed Drain Current I_{DM}^C		420		
Continuous Drain Current I_{DSM}	$T_A=25^\circ\text{C}$	14.5		A
	$T_A=70^\circ\text{C}$	11.5		
Avalanche Current I_{AS}^C		60		A
Avalanche energy E_{AS}^C	$L=0.1\text{mH}$	180		mJ
V_{DS} Spike	10µs	120		V
Power Dissipation P_D^B	$T_C=25^\circ\text{C}$	300	47	W
	$T_C=100^\circ\text{C}$	150	23	
Power Dissipation P_{DSM}^A	$T_A=25^\circ\text{C}$	2.1		W
	$T_A=70^\circ\text{C}$	1.3		
Junction and Storage Temperature Range	T_J, T_{STG}	-55 to 175		$^\circ\text{C}$

Thermal Characteristics

Parameter	Symbol	AOT(B)292L	AOTF292L	Units
Maximum Junction-to-Ambient $R_{\theta JA}^A$	$t \leq 10\text{s}$	15		$^\circ\text{C/W}$
Maximum Junction-to-Ambient $R_{\theta JA}^{AD}$	Steady-State	60		$^\circ\text{C/W}$
Maximum Junction-to-Case	Steady-State	0.5	3.2	$^\circ\text{C/W}$

* Surface mount package TO263

** Package limited for TO220 & TO263

Electrical Characteristics (T_J=25°C unless otherwise noted)

Symbol	Parameter	Conditions	Min	Typ	Max	Units
STATIC PARAMETERS						
BV _{DSS}	Drain-Source Breakdown Voltage	I _D =250μA, V _{GS} =0V	100			V
I _{DSS}	Zero Gate Voltage Drain Current	V _{DS} =100V, V _{GS} =0V T _J =55°C			1 5	μA
I _{GSS}	Gate-Body leakage current	V _{DS} =0V, V _{GS} =±20V			±100	nA
V _{GS(th)}	Gate Threshold Voltage	V _{DS} =V _{GS} , I _D =250μA	2.3	2.8	3.4	V
R _{DS(on)}	Static Drain-Source On-Resistance	V _{GS} =10V, I _D =20A TO220/TO220F T _J =125°C		3.7	4.5	mΩ
		V _{GS} =6V, I _D =20A TO220/TO220F		4.2	5.3	
		V _{GS} =10V, I _D =20A TO263		3.3	4.1	mΩ
		V _{GS} =6V, I _D =20A TO263		3.8	4.9	mΩ
g _{FS}	Forward Transconductance	V _{DS} =5V, I _D =20A		90		S
V _{SD}	Diode Forward Voltage	I _S =1A, V _{GS} =0V		0.68	1	V
I _S	Maximum Body-Diode Continuous Current (TO220/TO263) ^G				105	A
	Maximum Body-Diode Continuous Current (TO220F)				50	A
DYNAMIC PARAMETERS						
C _{iss}	Input Capacitance	V _{GS} =0V, V _{DS} =50V, f=1MHz		6775		pF
C _{oss}	Output Capacitance			557		pF
C _{riss}	Reverse Transfer Capacitance			32		pF
R _g	Gate resistance	f=1MHz	0.4	0.8	1.2	Ω
SWITCHING PARAMETERS						
Q _g (10V)	Total Gate Charge	V _{GS} =10V, V _{DS} =50V, I _D =20A		90	126	nC
Q _g (4.5V)	Total Gate Charge			40	60	nC
Q _{gs}	Gate Source Charge			24		nC
Q _{gd}	Gate Drain Charge			13.5		nC
t _{D(on)}	Turn-On Delay Time	V _{GS} =10V, V _{DS} =50V, R _L =2.5Ω, R _{GEN} =3Ω		20		ns
t _r	Turn-On Rise Time			11.5		ns
t _{D(off)}	Turn-Off Delay Time			48		ns
t _f	Turn-Off Fall Time			10		ns
t _{rr}	Body Diode Reverse Recovery Time	I _F =20A, di/dt=500A/μs		50		ns
Q _{rr}	Body Diode Reverse Recovery Charge	I _F =20A, di/dt=500A/μs		380		nC

A. The value of R_{θJA} is measured with the device mounted on 1in² FR-4 board with 2oz. Copper, in a still air environment with T_A=25° C. The Power dissipation P_{DSM} is based on R_{θJA} ≤ 10s and the maximum allowed junction temperature of 150° C. The value in any given application depends on the user's specific board design, and the maximum temperature of 175° C may be used if the PCB allows it.

B. The power dissipation P_D is based on T_{J(MAX)}=175° C, using junction-to-case thermal resistance, and is more useful in setting the upper dissipation limit for cases where additional heatsinking is used.

C. Single pulse width limited by junction temperature T_{J(MAX)}=175° C.

D. The R_{θJA} is the sum of the thermal impedance from junction to case R_{θJC} and case to ambient.

E. The static characteristics in Figures 1 to 6 are obtained using <300μs pulses, duty cycle 0.5% max.

F. These curves are based on the junction-to-case thermal impedance which is measured with the device mounted to a large heatsink, assuming a maximum junction temperature of T_{J(MAX)}=175° C. The SOA curve provides a single pulse rating.

G. The maximum current rating is package limited.

H. These tests are performed with the device mounted on 1 in² FR-4 board with 2oz. Copper, in a still air environment with T_A=25° C.

APPLICATIONS OR USE AS CRITICAL COMPONENTS IN LIFE SUPPORT DEVICES OR SYSTEMS ARE NOT AUTHORIZED. AOS DOES NOT ASSUME ANY LIABILITY ARISING OUT OF SUCH APPLICATIONS OR USES OF ITS PRODUCTS. AOS RESERVES THE RIGHT TO IMPROVE PRODUCT DESIGN, FUNCTIONS AND RELIABILITY WITHOUT NOTICE.

TYPICAL ELECTRICAL AND THERMAL CHARACTERISTICS

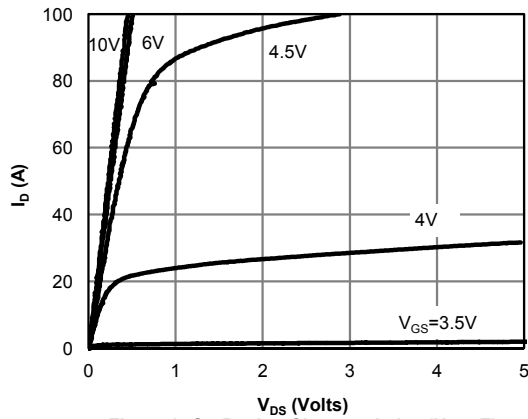

Figure 1: On-Region Characteristics (Note E)

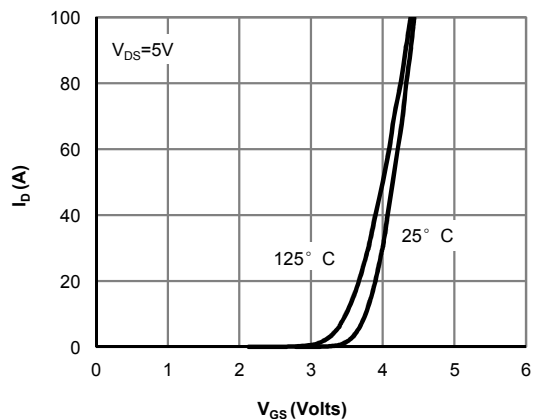

Figure 2: Transfer Characteristics (Note E)

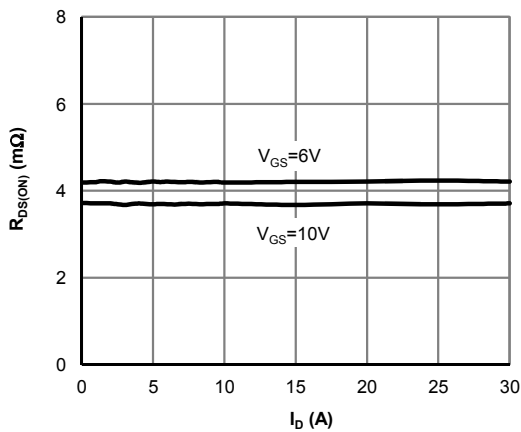

Figure 3: On-Resistance vs. Drain Current and Gate Voltage (Note E)

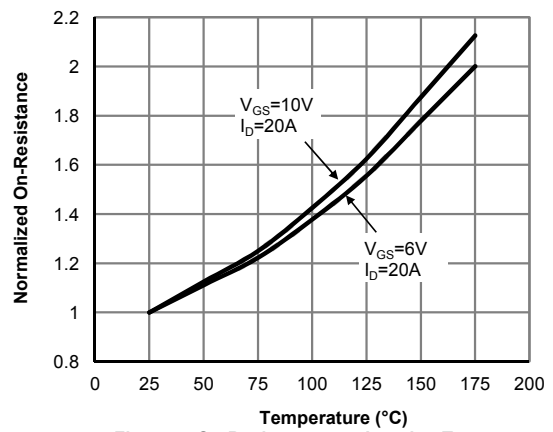

Figure 4: On-Resistance vs. Junction Temperature (Note E)

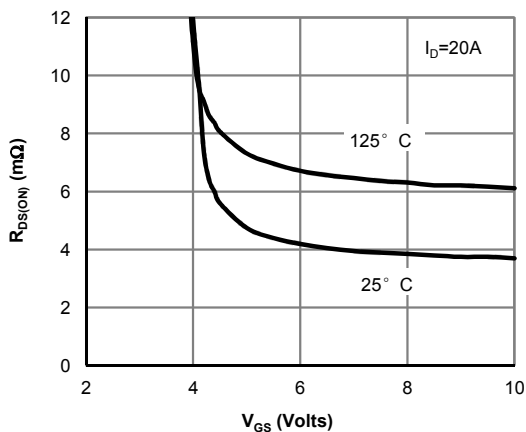

Figure 5: On-Resistance vs. Gate-Source Voltage (Note E)

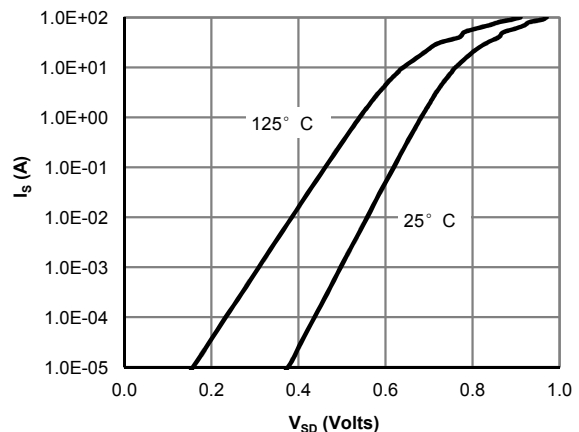

Figure 6: Body-Diode Characteristics (Note E)

TYPICAL ELECTRICAL AND THERMAL CHARACTERISTICS

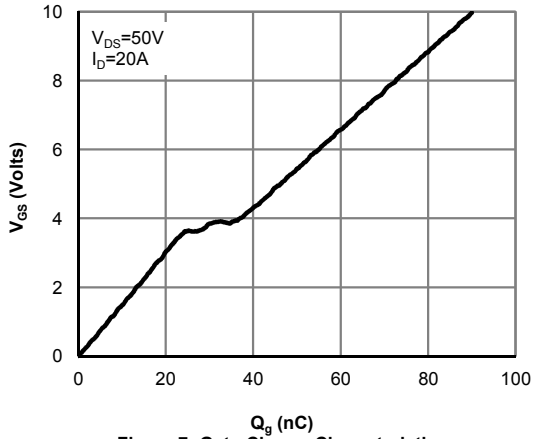

Figure 7: Gate-Charge Characteristics

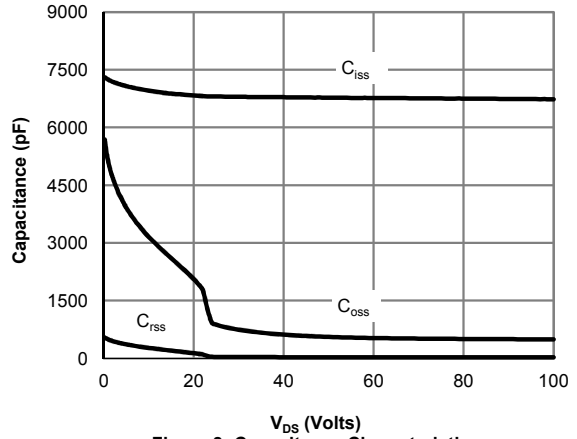

Figure 8: Capacitance Characteristics

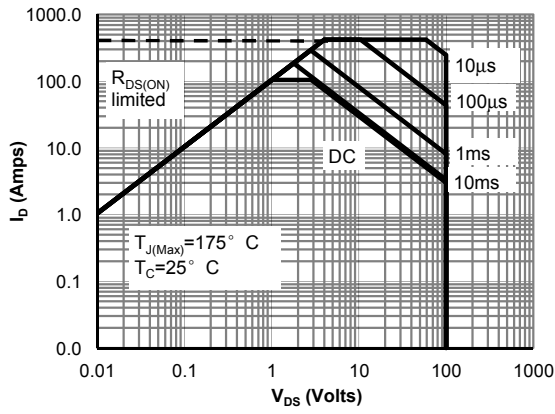

Figure 9A: Maximum Forward Biased Safe Operating Area for TO220 & TO263 (Note F)

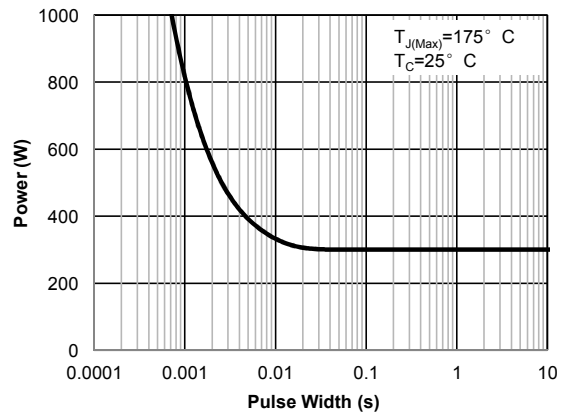

Figure 10A: Single Pulse Power Rating Junction-to-Case for TO220 & TO263 (Note F)

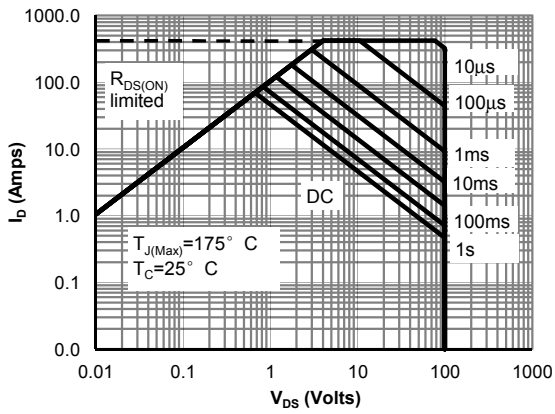

Figure 9B: Maximum Forward Biased Safe Operating Area for TO220F (Note F)

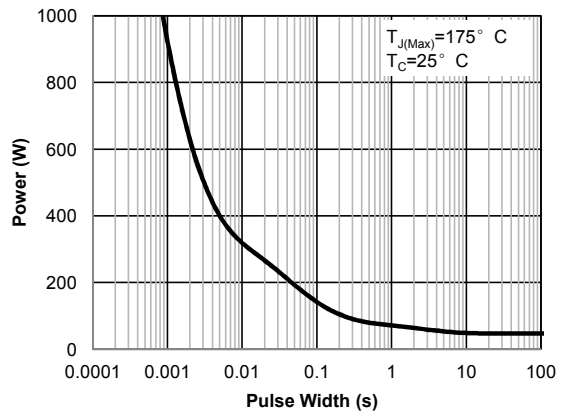

Figure 10B: Single Pulse Power Rating Junction-to-Case for TO220F (Note F)

TYPICAL ELECTRICAL AND THERMAL CHARACTERISTICS

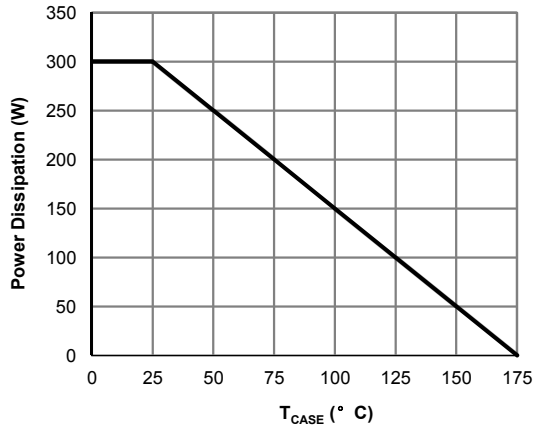

Figure 11A: Power De-rating for TO220 & TO263 (Note F)

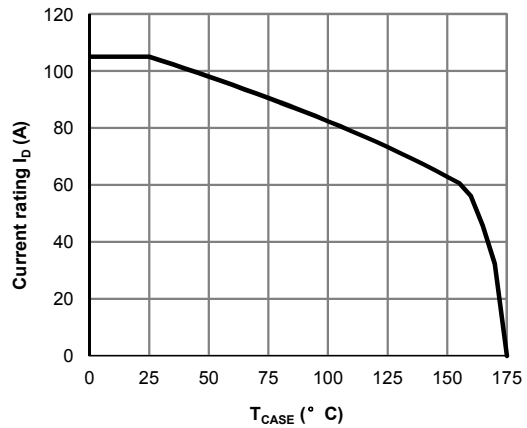

Figure 12A: Current De-rating for TO220 & TO263 (Note F)

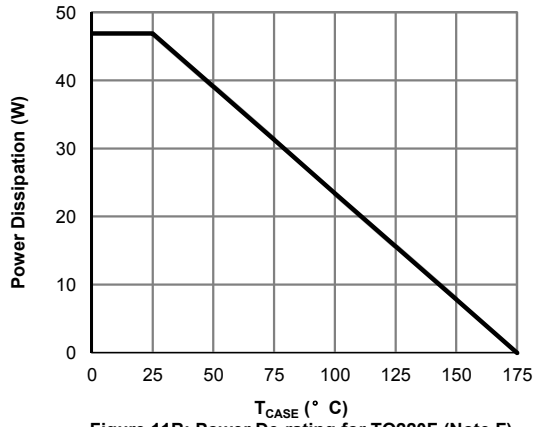

Figure 11B: Power De-rating for TO220F (Note F)

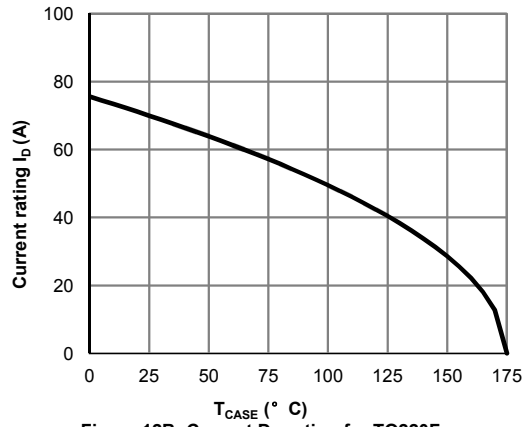

Figure 12B: Current De-rating for TO220F (Note F)

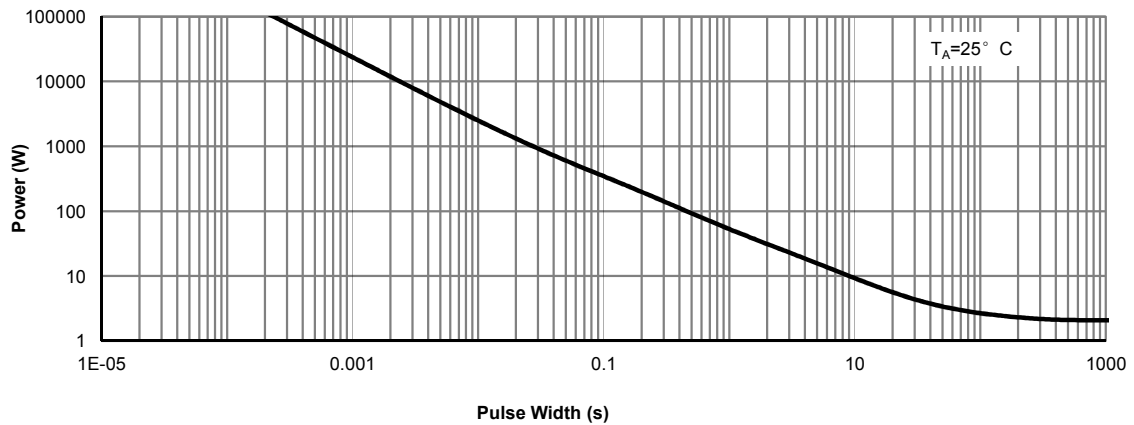

Figure 13: Single Pulse Power Rating Junction-to-Ambient (Note H)

TYPICAL ELECTRICAL AND THERMAL CHARACTERISTICS

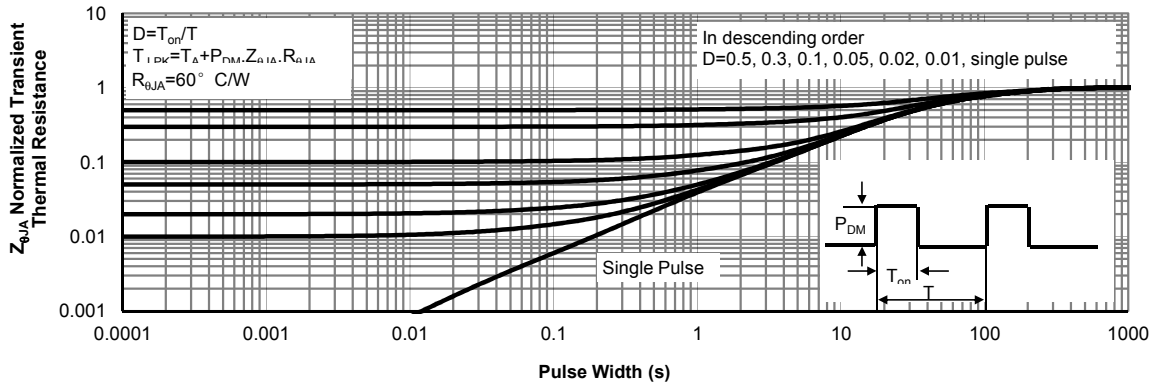

Figure 14: Normalized Maximum Transient Thermal Impedance (Note H)

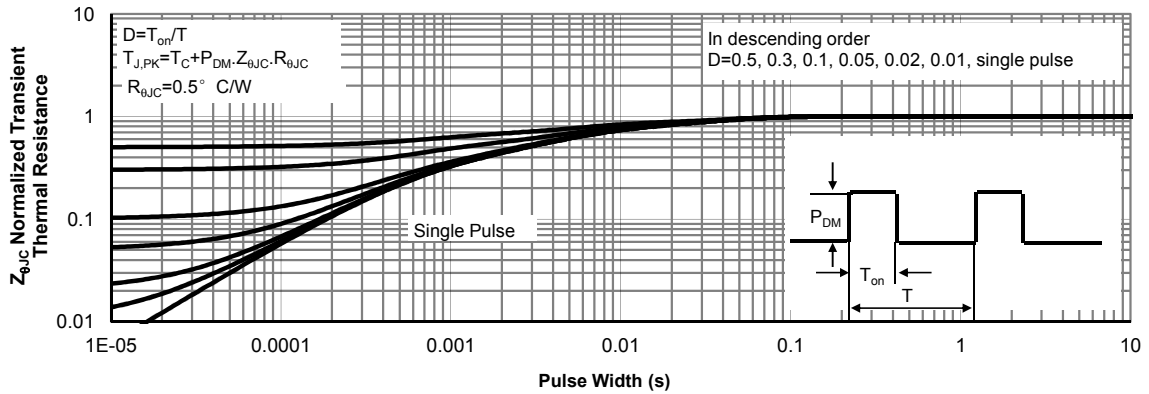

Figure 15A: Normalized Maximum Transient Thermal Impedance for TO220 & TO263 (Note F)

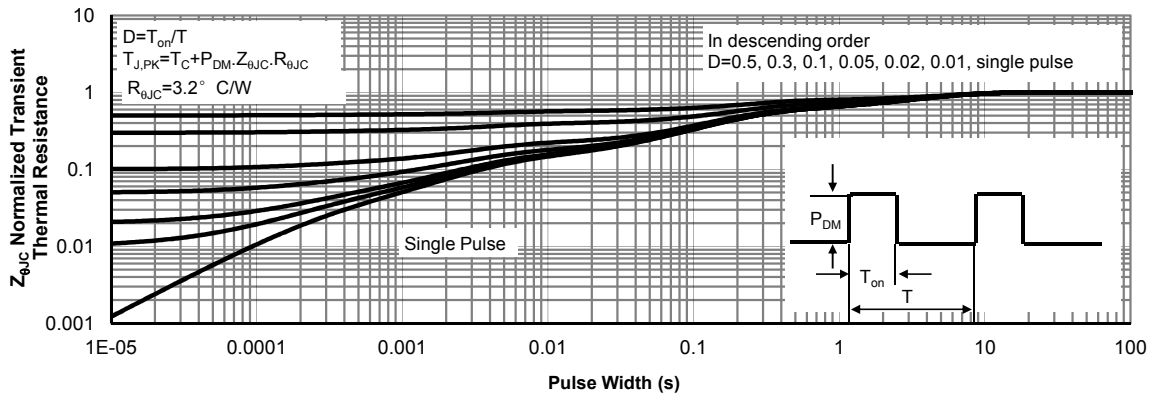

Figure 15B: Normalized Maximum Transient Thermal Impedance for TO220F (Note F)

Figure A: Gate Charge Test Circuit & Waveforms

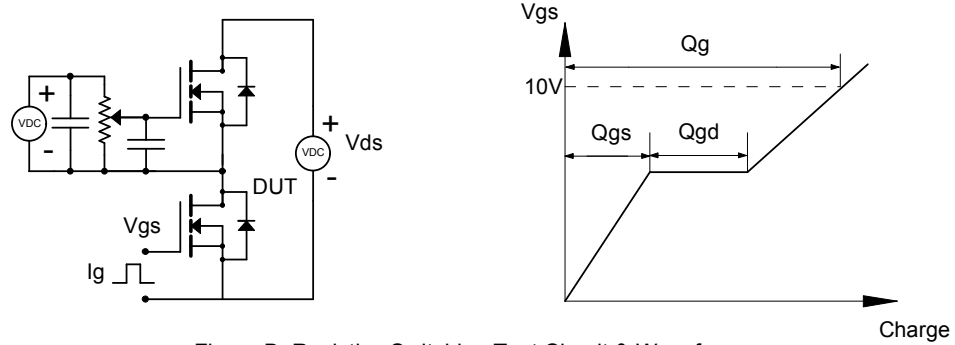

Figure B: Resistive Switching Test Circuit & Waveforms

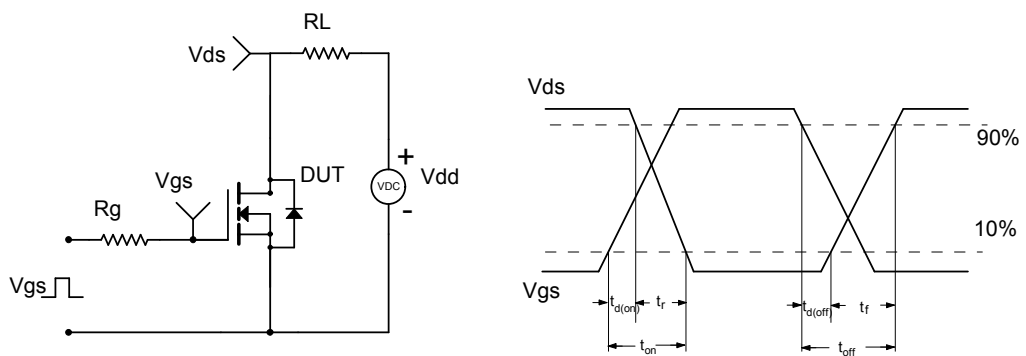

Figure C: Unclamped Inductive Switching (UIS) Test Circuit & Waveforms

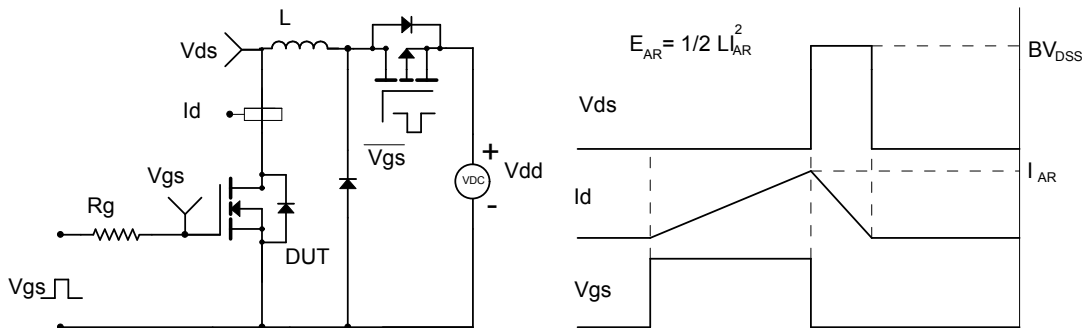

Figure D: Diode Recovery Test Circuit & Waveforms

