

P12347-01CT

Color sensor, proximity sensor, and 3-color LED incorporated into a single package

This is a multifunctional sensor that incorporates a color sensor, proximity sensor, and 3-color LED in a small package (5.5 × 1.7 × 1.0 mm). It can be used to adjust the display image quality, perform touchscreen on/off control, indicate incoming calls, and so forth on smartphones and the like. The color sensor not only detects the RGB ratios of ambient light but also functions as an illuminance sensor. This feature enables image quality to be adjusted in fine detail. In smartphone applications, the proximity sensor detects when a face draws near and turns off the touchscreen function and the LCD backlight. We provide an evaluation kit for this product as well as an evaluation board. Contact us for detailed information.

Features

- I²C interface: 400 kHz, Fast mode
- Low supply voltage: V_{dd}=2.25 V to 3.63 V
- I²C bus voltage: 1.65 V
- Low current consumption
- Small package (5.5 × 1.7 × 1.0 mm)
- Supports lead-free reflow soldering

Applications

- Smartphones, TV and PC displays, tablets, etc. (image quality adjustment, touchscreen on/off control, incoming call indication)

Absolute maximum ratings (T_a=25 °C)

Parameter	Symbol	Condition	Value	Unit
Supply voltage	V _{dd}		-0.3 to +4	V
Load current	I _o		±10	mA
Power dissipation	P		100	mW
Operating temperature	T _{opr}	No dew condensation*1	-30 to +80	°C
Storage temperature	T _{stg}	No dew condensation*1	-40 to +85	°C
LED forward current	I _F		Red: 30, Green, Blue: 20*2	mA
LED pulse forward current	I _F		100*2 *3	mA
LED reverse voltage	V _R		5*2	V
Reflow soldering conditions*4	T _{sol}		Peak temperature 260 °C max., 3 times	-

*1: When there is a temperature difference between a product and the surrounding area in high humidity environment, dew condensation may occur on the product surface. Dew condensation on the product may cause deterioration in characteristics and reliability.

*2: When driven externally

*3: Duty ratio ≤ 10%, pulse width ≤ 0.1 ms

*4: Moisture absorption and reflow conditions: JEDEC J-STD-020D LEVEL3

Note: Exceeding the absolute maximum ratings even momentarily may cause a drop in product quality. Always be sure to use the product within the absolute maximum ratings.

Recommended operating conditions

Parameter	Symbol	Condition	Min.	Typ.	Max.	Unit
Supply voltage	V _{dd}		2.25	-	3.63	V
I ² C bus pull-up voltage*5	V _{bus}	R _p =2.2 kΩ	1.65	-	V _{dd} + 0.5	V
High level input voltage (SDA, SCL)	V _{ih}		1.55	-	V _{dd} + 0.5	V
Low level input voltage (SDA, SCL)	V _{il}		-0.5	-	0.3 × V _{bus}	V
Bus capacitance (SDA, SCL)	C _{bus}		-	-	400	pF

*5: The pull-up resistance is determined by the C_{bus} capacitance and V_{bus} voltage. Satisfy the following condition: V_{dd} - V_{bus} < 1.2 V.

Electrical and optical characteristics

- Color sensor area [Ta=25 °C, Vdd=3.3 V, light source A (initial setting: low gain, integration time: 100 ms/ch), unless otherwise noted]

Parameter		Symbol	Condition	Min.	Typ.	Max.	Unit	
Spectral response range		λ	Blue	395 to 530			nm	
			Green	490 to 600				
			Red	590 to 660				
Peak sensitivity wavelength		λ_p	Blue	-	465	-	nm	
			Green	-	540	-		
			Red	-	635	-		
Current consumption	Operation mode	I _{dd}	E=0 lx (dark state), excluding output current	30	75	150	μ A	
	Standby mode	I _{dds}		0.1	1.0	3.0		
Dark count		S _d	E=0 lx (dark state), initial setting	-	-	5	counts	
Photosensitivity	High gain		Integration time=100 ms/ch	S _{bh} Blue	63.8	116	168.1	counts/lx
				S _{gh} Green	67.5	122.6	177.7	
				S _{rh} Red	121.5	220.8	320.1	
				S _{irh} Infrared	39.9	72.4	104.9	
High/Low sensitivity gain ratio		-		4.8	5.3	5.8	times	
Red/Blue sensitivity ratio		High gain	Integration time=100 ms/ch Same chip	S _{rh} /S _{bh}	1.43	1.91	2.38	-
Red/Green sensitivity ratio				S _{rh} /S _{gh}	1.36	1.81	2.25	
Blue/Green sensitivity ratio				S _{bh} /S _{gh}	0.71	0.95	1.18	

- I²C area (Ta=25 °C, Vdd=Vbus=3.3 V, unless otherwise noted)

Parameter		Symbol	Condition	Min.	Typ.	Max.	Unit
I ² C address		ADDR	7-bit	0x2A			
I ² C clock frequency		f _{clk}		1	-	400	kHz
SDA, SCL output voltage	High level	V _{oh}	R _p =2.2 k Ω	0.8V _{bus}	-	-	V
	Low level	V _{ol}	R _p =2.2 k Ω	0	-	0.4	V
I/O terminal capacitance		C _i		-	-	20	pF
SDA/SCL output fall time*5		t _f	R _p =2.2 k Ω , C _p =400 pF	-	-	250	ns

*5: The SCL/SDA output rise time is determined by the time constant defined by C_{bus} × R_p.

Note: I²C interface (SDA, SCL) timing complies with "The I²C-bus specification version 2.1."

- Proximity sensor area (Ta=25 °C, Vdd=3.3 V, unless otherwise noted)

Parameter		Symbol	Condition	Min.	Typ.	Max.	Unit
Peak sensitivity wavelength		λ		-	635	-	nm
Photosensitivity		R	λ =630 nm	-	0.4	-	A/W
Distance measurement current consumption		I _{ddp}	During operation	-	1000	-	μ A
High level LED pulse width		T _w		-	16	-	μ s
LED drive current		I _{LED}	When set to maximum*6	-	96	-	mA
Allowable background light level		E _x		-	-	5000	lx
Measurement time		T _m	When set to minimum (3 pulses)	-	400	-	μ s
Detection distance			I _{LED} =32 mA, T _H =32, reflector=white	-	-	30	mm

*6: Set the LED drive current to 100 mA or less. Set the red LED register to 0x0C or less.

- LED area (Ta=25 °C, Vdd=3.3 V, unless otherwise noted)

Parameter		Symbol	Condition	Min.	Typ.	Max.	Unit	
Forward voltage	V _F		Red	I _F =5 mA	1.4	1.85	2.4	V
			Green		2.4	2.7	3.1	
			Blue		2.4	2.75	3.1	
Reverse current	I _R		Red	V _R =5 V	-	-	100	μ A
			Green		-	-	2	
			Blue		-	-	2	
Luminous intensity	I _v		Red	I _F =5 mA	-	40	-	mcd
			Green		-	220	-	
			Blue		-	65	-	
Dominant wavelength	λ_d		Red	I _F =5 mA	605	615	625	nm
			Green		520	530	540	
			Blue		463	470	477	
Pulse forward current		I _{FP}	Duty ratio < 10%, pulse width < 0.1 ms	-	-	100	mA	

Register map

Adrs	Function	bit							
		7	6	5	4	3	2	1	0
00	RGB sensor control	Color sensor reset	Sleep function	Color sensor sleep function monitor	Color sensor register reset	Gain selection	Integration mode	Integration time setting	
01	Manual timing (high byte)	Manual timing (low byte)							
02	Manual timing (low byte)								
03	Output data (high byte)	Red channel data (16-bit)							
04	Output data (low byte)								
05	Output data (high byte)	Green channel data (16-bit)							
06	Output data (low byte)								
07	Output data (high byte)	Blue channel data (16-bit)							
08	Output data (low byte)								
09	Output data (high byte)	Infrared channel data (16-bit)							
0A	Output data (low byte)								
0B	Proximity sensor control 1	Proximity sensor reset	Proximity sensor sleep function			Red LED drive current selection for proximity sensor			
0C	Proximity sensor control 2	Proximity sensor duration selection				Pulse count selection			
0D	Proximity sensor threshold	Proximity sensor threshold control (8-bit)*8							
0E	3-color LED drive control 1*9	3-color LED reset	3-color LED sleep function	DC mode	1/10 mode	Red LED drive current selection			
0F	3-color LED drive control 2	Green LED drive current selection				Blue LED drive current selection			
10	Monitor	INT monitor	Color sensor sleep function monitor	Pulse count monitor					

*8: Set the threshold level to 0x10 (10000 in binary notation) or higher.

*9: With the initial setting, the 3-color LED emits pulses. When set to DC mode, it emits DC light.

Note: When using the LED in DC mode, set the current for red to 30 mA or less and that for green and blue to 20 mA or less.

If the LED forward current is set to a high level, the LED will illuminate brightly. Be careful as the bright light may be hazardous to the eyes if viewed directly.

Register map (initial settings)

Adrs	bit							
	7	6	5	4	3	2	1	0
0	Color sensor reset	Sleep function	Color sensor sleep function monitor	Color sensor register reset	Gain selection	Integration mode	Integration time setting	
Initial setting	1	1		1	0	1	0	0
	0: operation 1: reset	0: operation 1: sleep	Read only	0: reset release 1: address 03-0A	0: high gain 1: low gain	0: fixed time mode 1: manual setting mode	Integration time setting (00) 32 μ s (01) 0.5 ms (10) 8.2 ms (11) 65.5 ms	
0B	Proximity sensor reset	Proximity sensor sleep function			Red LED drive current selection for proximity sensor			
Initial setting	1	1	0	0	0	0	0	0
	0: operation 1: reset	0: operation 1: sleep			0: 0 mA 1: 64 mA	0: 0 mA 1: 32 mA	0: 0 mA 1: 16 mA	0: 0 mA 1: 8 mA
0C	Proximity sensor duration selection				Pulse count selection			
Initial setting	1	1	1	1	0	0	0	1
	0: 0 s 1: 524 ms	0: 0 s 1: 262 ms	0: 0 s 1: 131 ms	0: 0 s 1: 64 ms	0: 0 1: 24 pulses	0: 0 1: 12 pulses	0: 0 1: 6 pulses	0: 0 1: 3 pulses
0D	Proximity sensor threshold control (8-bit)							
Initial setting	0	0	0	0	0	0	0	0
Threshold voltage	0: 0 s 1: 825 mV	0: 0 s 1: 413 mV	0: 0 s 1: 206 mV	0: 0 s 1: 103 mV	0: 0 1: 51.6 mV	0: 0 1: 25.8 mV	0: 0 1: 12.9 mV	0: 0 1: 6.4 mV

Note: The initial settings may vary depending on the product.

Register map (initial settings)

Adrs	bit							
	7	6	5	4	3	2	1	0
OE	3-color LED reset	3-color LED sleep function	DC mode	1/10 mode	Red LED drive current selection			
Initial setting	0	0	0	0	0	0	0	0
Threshold voltage	0: operation 1: reset	0: operation 1: sleep	0: pulse mode 1: DC mode	0: normal mode 1: 1/10 mode	0: 0 1: 64 mV	0: 0 1: 32 mV	0: 0 1: 16 mV	0: 0 1: 1.8 mV
OF	Green LED drive current selection				Blue LED drive current selection			
Initial setting	0	0	0	0	0	0	0	0
Threshold voltage	0: 0 mA 1: 64 mA	0: 0 mA 1: 32 mA	0: 0 mA 1: 16 mA	0: 0 mA 1: 8 mA	0: 0 mA 1: 64 mA	0: 0 mA 1: 32 mA	0: 0 1: 16 mA	0: 0 1: 8 mA

Program example

Condition 1: Initial settings [manual setting mode, Tint=00 (32 μs), integration time=100 ms/ch (manual timing register set to 0x0C30)]

Command

Action		Data body								Ack	Remark
Address call (0x2A)	S	0	1	0	1	0	1	0	W	A	7-bit address
Register call (0x00)		0	0	0	0	0	0	0	0	A	Specifies the control byte
Register write (0x84)		1	0	0	0	0	1	0	0	A	ADC reset, standby release
Address call (0x2A)	Sr	0	1	0	1	0	1	0	W	A	Restart, address
Register call (0x00)		0	0	0	0	0	0	0	0	A	Specifies the control byte
Register write (0x04)		0	0	0	0	0	1	0	0	A	P ADC reset release, bus release
Stands by for longer than the integration time (standby time > 400 ms)											
Address call (0x2A)	S	0	1	0	1	0	1	0	W	A	7-bit address
Register call (0x03)		0	0	0	0	0	0	1	1	A	Specifies the output data byte
Address call (0x2A)	Sr	0	1	0	1	0	1	0	R	A	Changes to read mode
Data read out (Red: high byte)		X	X	X	X	X	X	X	X	A	Red data output
Data read out (Red: low byte)		X	X	X	X	X	X	X	X	A	
Data read out (Green: high byte)		X	X	X	X	X	X	X	X	A	Green data output
Data read out (Green: low byte)		X	X	X	X	X	X	X	X	A	
Data read out (Blue: high byte)		X	X	X	X	X	X	X	X	A	Blue data output
Data read out (Blue: low byte)		X	X	X	X	X	X	X	X	A	
Data read out (infrared: high byte)		X	X	X	X	X	X	X	X	A	Infrared data output
Data read out (infrared: low byte)		X	X	X	X	X	X	X	X	\bar{A} P	

S=Start condition, Sr=Restart condition, A=Acknowledge, A=Acknowledge by host, P=Stop condition, R=Read mode (1), W=Write mode (0), \bar{A} =not acknowledge

Format

S	0x2A (7-bits)	W	A	0x00	A	0x84	A
---	---------------	---	---	------	---	------	---

Sr	0x2A (7-bits)	W	A	0x00	A	0x04	A	P
----	---------------	---	---	------	---	------	---	---

Standby

S	0x2A (7-bits)	W	A	0x03	A	Sr	0x2A (7-bits)	R	A
---	---------------	---	---	------	---	----	---------------	---	---

Sensor data	A	Sensor data	A
-------------	---	-------------	---

Sensor data	A	Sensor data	A
-------------	---	-------------	---

Sensor data	A	Sensor data	A
-------------	---	-------------	---

Sensor data	A	Sensor data	\bar{A} P
-------------	---	-------------	---------------

from master to slave

from slave to master

Condition 2: [Fixed time mode, Tint=01 (1.0 ms), integration time=1.0 ms/ch]

■ Command

Action		Data body								Ack	Remark
Address call (0x2A)	S	0	1	0	1	0	1	0	W	A	7-bit address
Register call (0x00)		0	0	0	0	0	0	0	0	A	Specifies the control byte
Register write (0x81)		1	0	0	0	0	0	0	1	A	ADC reset, standby release
Address call (0x2A)	Sr	0	1	0	1	0	1	0	W	A	Restart, bit address
Register call (0x00)		0	0	0	0	0	0	0	0	A	Specifies the control byte
Register write (0x01)		0	0	0	0	0	0	0	1	A	P ADC reset release, bus release
Stands by for longer than the integration time Measurement takes place during standby (standby time > 4 ms). Measurements are repeated continuously.											
Address call (0x2A)	S	0	1	0	1	0	1	0	W	A	7-bit address
Register call (0x03)		0	0	0	0	0	0	1	1	A	Specifies the sensor data byte
Address call (0x2A)	Sr	0	1	0	1	0	1	0	R	A	Changes to read mode
Data read out (Red: high byte)		X	X	X	X	X	X	X	X	A	Red data output
Data read out (Red: low byte)		X	X	X	X	X	X	X	X	A	
Data read out (Green: high byte)		X	X	X	X	X	X	X	X	A	Green data output
Data read out (Green: low byte)		X	X	X	X	X	X	X	X	A	
Data read out (Blue: high byte)		X	X	X	X	X	X	X	X	A	Blue data output
Data read out (Blue: low byte)		X	X	X	X	X	X	X	X	A	
Data read out (infrared: high byte)		X	X	X	X	X	X	X	X	A	Infrared data output
Data read out (infrared: low byte)		X	X	X	X	X	X	X	X	\bar{A} P	

S=Start condition, Sr=Restart condition, A=Acknowledge, A=Acknowledge by host, P=Stop condition, R=Read mode (1), W=Write mode (0), \bar{A} =not acknowledge

■ Format

S	0x2A (7-bits)	W	A	0x00	A	0x81	A
---	---------------	---	---	------	---	------	---

Sr	0x2A (7-bits)	W	A	0x00	A	0x01	A	P
----	---------------	---	---	------	---	------	---	---

Standby

S	0x2A (7-bits)	W	A	0x03	A	Sr	0x2A (7-bits)	R	A
---	---------------	---	---	------	---	----	---------------	---	---

Sensor data	A	Sensor data	A
-------------	---	-------------	---

Sensor data	A	Sensor data	A
-------------	---	-------------	---

Sensor data	A	Sensor data	A
-------------	---	-------------	---

Sensor data	A	Sensor data	\bar{A}	P
-------------	---	-------------	-----------	---

from master to slave

from slave to master

KPIC00319EA

Condition 3: [Manual setting mode, Tint=01 (1.0 ms), integration time=357 ms/ch]

■ Command

Action		Data body								Ack	Remark	
Address call (0x2A)	S	0	1	0	1	0	1	0	0	W	A	7-bit address
Register call (0x00)		0	0	0	0	0	0	0	0		A	Specifies the control byte
Register write (0x85)		1	0	0	0	0	1	0	1		A	ADC reset, standby release
Register write (0x01)		0	0	0	0	0	0	0	1		A	Manual timing high byte
Register write (0x65)		0	1	1	0	0	1	0	1		A	Manual timing low byte
Address call (0x2A)	Sr	0	1	0	1	0	1	0	0	W	A	Restart, 7-bit address
Register call (0x00)		0	0	0	0	0	0	0	0		A	Specifies the control byte
Register write (0x05)		0	0	0	0	0	1	0	1		A	P ADC reset release, bus release
Stands by for longer than the integration time. Measurement takes place during standby (standby time > 1428 ms). Measurements are repeated continuously.												
Address call (0x2A)	S	0	1	0	1	0	1	0	0	W	A	7-bit address
Register call (0x03)		0	0	0	0	0	0	1	1		A	Specifies the sensor data byte
Address call (0x2A)	Sr	0	1	0	1	0	1	0	0	R	A	Changes to read mode
Data read out (Red: high byte)		X	X	X	X	X	X	X	X		A	Red data output
Data read out (Red: low byte)		X	X	X	X	X	X	X	X		A	
Data read out (Green: high byte)		X	X	X	X	X	X	X	X		A	Green data output
Data read out (Green: low byte)		X	X	X	X	X	X	X	X		A	
Data read out (Blue: high byte)		X	X	X	X	X	X	X	X		A	Blue data output
Data read out (Blue: low byte)		X	X	X	X	X	X	X	X		A	
Data read out (infrared: high byte)		X	X	X	X	X	X	X	X		A	Infrared data output
Data read out (infrared: low byte)		X	X	X	X	X	X	X	X	\bar{A}	P	

S=Start condition, Sr=Restart condition, A=Acknowledge, A=Acknowledge by host, P=Stop condition, R=Read mode (1), W=Write mode (0), \bar{A} =not acknowledge

■ Format

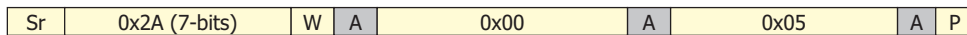
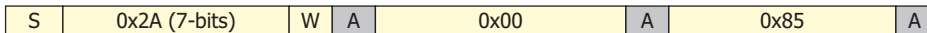

Standby

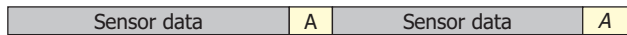
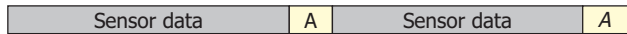
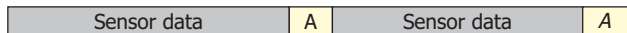
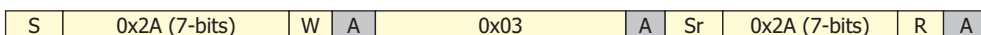

from master to slave from slave to master

KPIC0320EA

Condition 4: [Red LED drive current=0xC (96 mA), proximity cycle=0x01 (64 ms), pulse count=0x01 (3 times), threshold level=0x20 (32)]

■ Command

· Starting operation

Action		Data body								Ack	Remark
Address call (0x2A)	S	0	1	0	1	0	1	0	W	A	7-bit address
Register call (0x0B)		0	0	0	0	1	0	1	1	A	Specifies the control byte
Register write (0x8C)		1	0	0	0	1	1	0	0	A	Sleep release, drive current
Register write (0x11)		0	0	0	1	0	0	0	1	A	Proximity cycle, pulse count
Register write (0x20)		0	0	1	0	0	0	0	0	A	Threshold level
Address call (0x2A)	Sr	0	1	0	1	0	1	0	W	A	Restart, 7-bit address
Register call (0x0B)		0	0	0	0	1	0	1	1	A	Specifies the control byte
Register write (0x0C)		0	0	0	0	1	1	0	0	A	P Proximity reset release, bus release

· Monitor bit 7 at address 0x10 to read the value of INT from I²C.

Action		Data body								Ack	Remark
Address call (0x2A)	S	0	1	0	1	0	1	0	W	A	7-bit address
Register call (0x10)		0	0	0	1	0	0	0	0	A	Specifies the output data byte
Address call (0x2A)	Sr	0	1	0	1	0	1	0	R	A	Changes to read mode
Data read out		X	X	X	X	X	X	X	X	\bar{A}	P

· Ending operation

Action		Data body								Ack	Remark
Address call (0x2A)	S	0	1	0	1	0	1	0	W	A	7-bit address
Register call (0x0B)		0	0	0	0	1	0	1	1	A	Specifies the output data byte
Register write (0xCC)		1	1	0	0	1	1	0	0	A	P Sleep

S=Start condition, Sr=Restart condition, A=Acknowledge, \bar{A} =Acknowledge by host, P=Stop condition, R=Read mode (1), W=Write mode (0), \bar{A} =not acknowledge

■ Format

· Starting operation

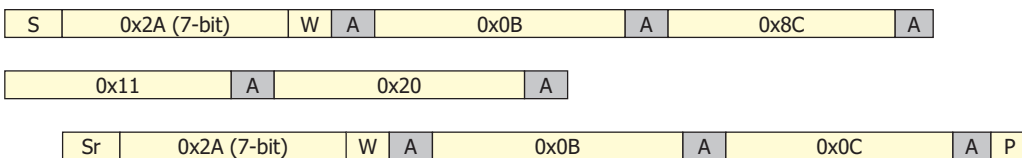

· Reading INT from I²C

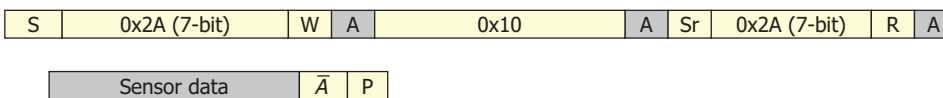

· Ending operation

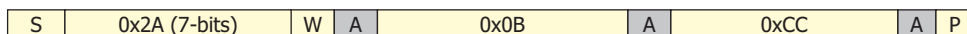

from master to slave from slave to master

KPIC0321EA

Condition 5: [Red LED light emission pulse width=0x01 (16 μs), green LED light emission pulse width=0x01 (16 μs), blue LED light emission pulse width=0x01 (16 μs)]

■ Command

· Starting operation

Action		Data body								Ack	Remark
Address call (0x2A)	S	0	1	0	1	0	1	0	W	A	7-bit address
Register call (0x0E)		0	0	0	0	1	1	1	0	A	Specifies the control byte
Register write (0x81)		1	0	0	0	0	0	0	1	A	Sleep release, red light emission pulse width
Register write (0x11)		0	0	0	1	0	0	0	1	A	Green light emission pulse width, blue light emission pulse width
Address call (0x2A)	Sr	0	1	0	1	0	1	0	W	A	Restart, 7-bit address
Register call (0x0E)		0	0	0	0	1	1	1	0	A	Specifies the control byte
Register write (0x01)		0	0	0	0	0	0	0	1	A	P LED driver reset release, bus release

· Ending operation

Action		Data body								Ack	Remark
Address call (0x2A)	S	0	1	0	1	0	1	0	W	A	7-bit address
Register call (0x0E)		0	0	0	0	1	1	1	0	A	Specifies the control byte
Register write (0xC1)		1	1	0	0	0	0	0	1	A	P Sleep

S=Start condition, Sr=Restart condition, A=Acknowledge, A=Acknowledge by host, P=Stop condition, R=Read mode (1), W=Write mode (0), \bar{A} =not acknowledge

■ Format

· Starting operation

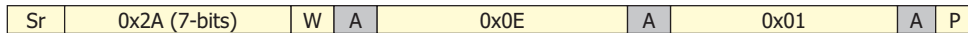
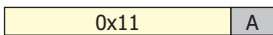
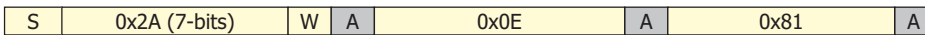

· Ending operation

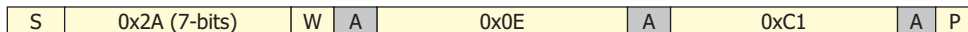

from master to slave from slave to master

KPIC0322EA

Flowcharts

■ Color sensor

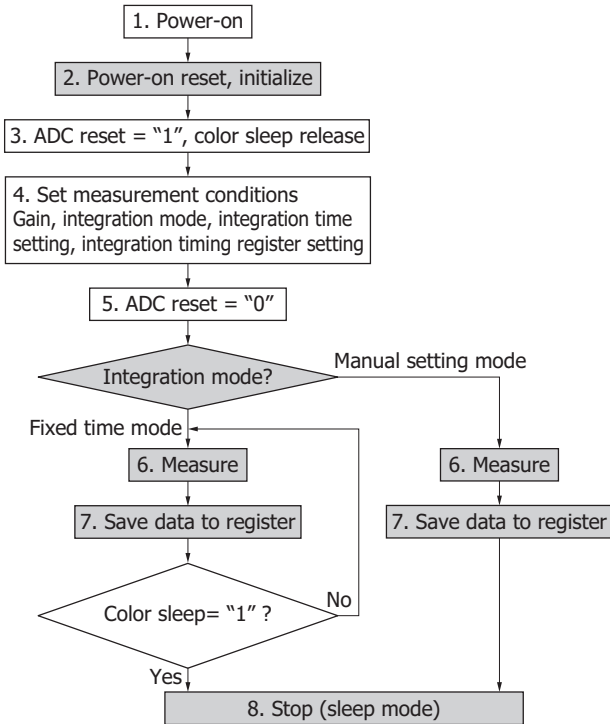

KPIC0323EA

After power-on, the built-in power-on reset circuit operates to set all registers to their initial conditions (2.).

With the initial settings, the product is in sleep mode, waiting for commands.

To set measurement conditions, enter commands via the I²C bus. This product starts measuring when ADC reset changes from 1 to 0. Therefore, to write to registers, ADC reset must be set to 1 (3.).

After setting measurement conditions (4.), release ADC reset to start measuring (5.). There are two operation modes: fixed time mode and manual setting mode. In manual setting mode, the product automatically enters sleep mode after completing a single measurement. In fixed time mode, the product repeats measurement and data storage. During this repetition, if ADC reset or Color sleep is set to 1 with an I²C command, the product stops its operation.

■ Proximity sensor

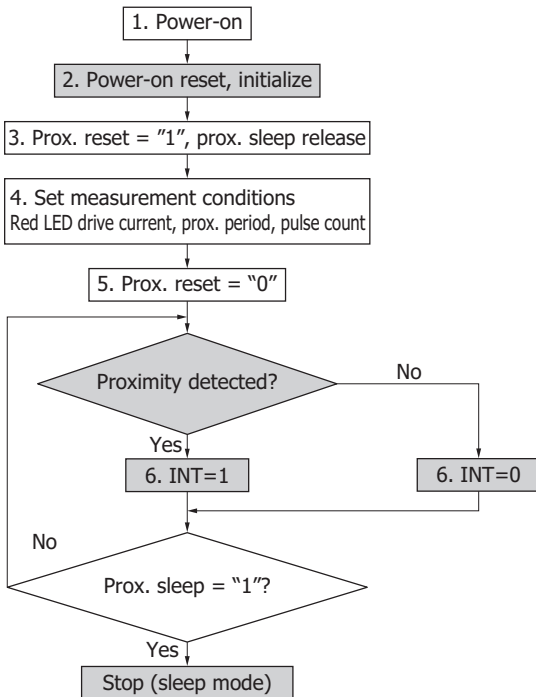

KPIC0324EA

With the initial settings, the proximity sensor is in sleep mode. Therefore, first disable the sleep mode (3.). Next, set the drive current, pulse count, pulse cycle, and the like. Then, release the reset to start measuring (4. 5.). Proximity sensor continues to measure until it is set to sleep mode. To end measurement, enable sleep mode.

3-color LED

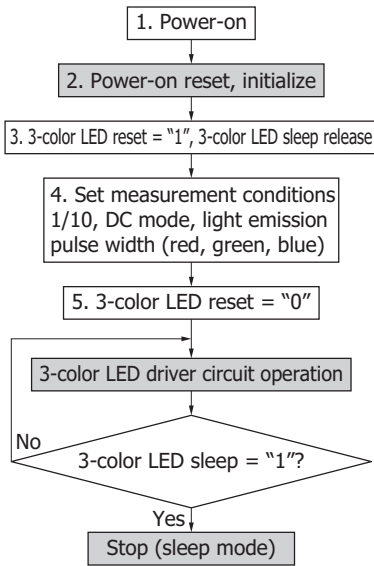

KPIC00325EA

With the initial settings, the 3-color LED driver is in sleep mode. Therefore, first disable the standby mode (3). Next, set the light emission pulse width of each color, 1/10 mode, and the like. Then, release the reset to start measuring (4, 5). 3-color LED drivers continue to operate until they are set to sleep mode. To end operation, enable standby mode.

Spectral response

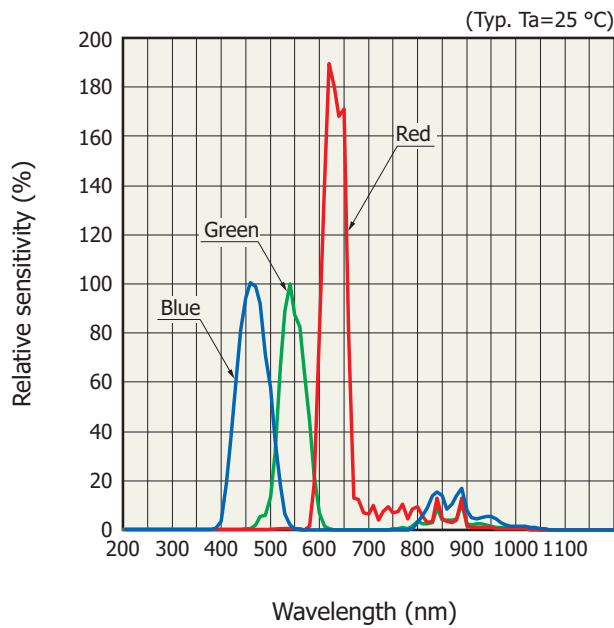

KPIC0179EC

Linearity

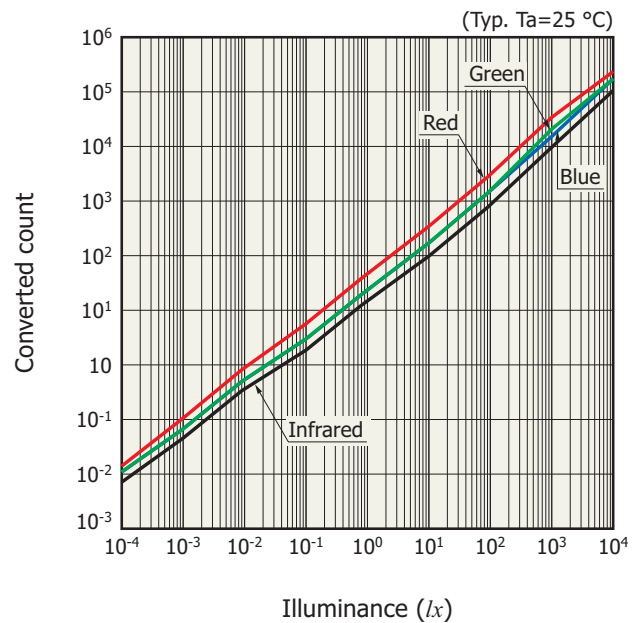

KPIC0183EA

Proximity distance vs. LED current

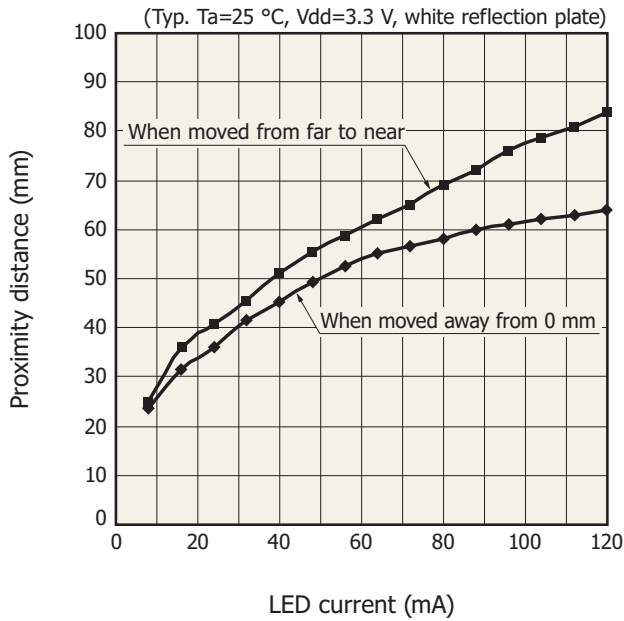

KPICB0180EA

Proximity distance vs. LED current (by color)

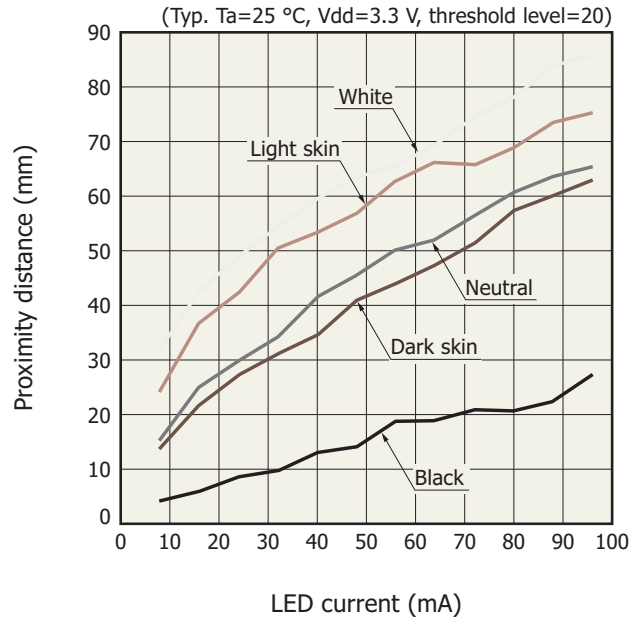

KPICB0186EA

Maximum LED forward current vs. ambient temperature (typical example)

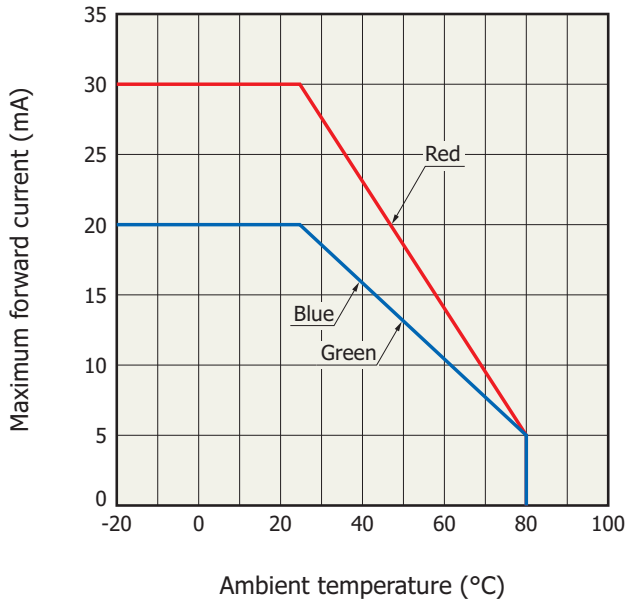

KPICB0184EA

LED power dissipation vs. ambient temperature (typical example)

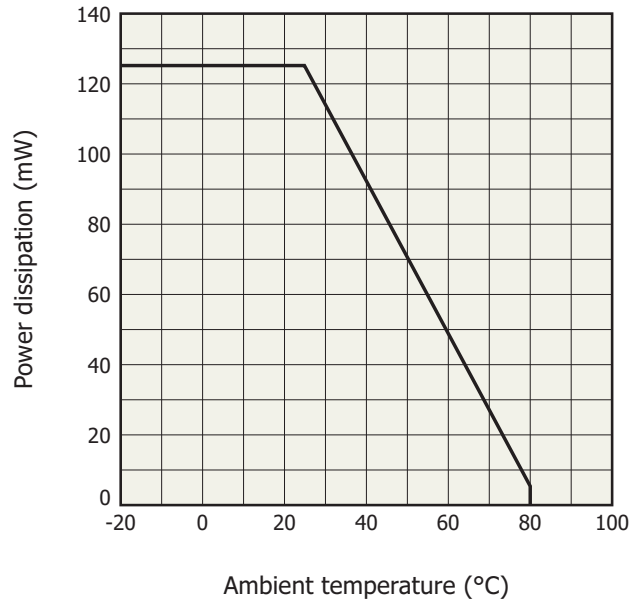

KPICB0185EA

Block diagram

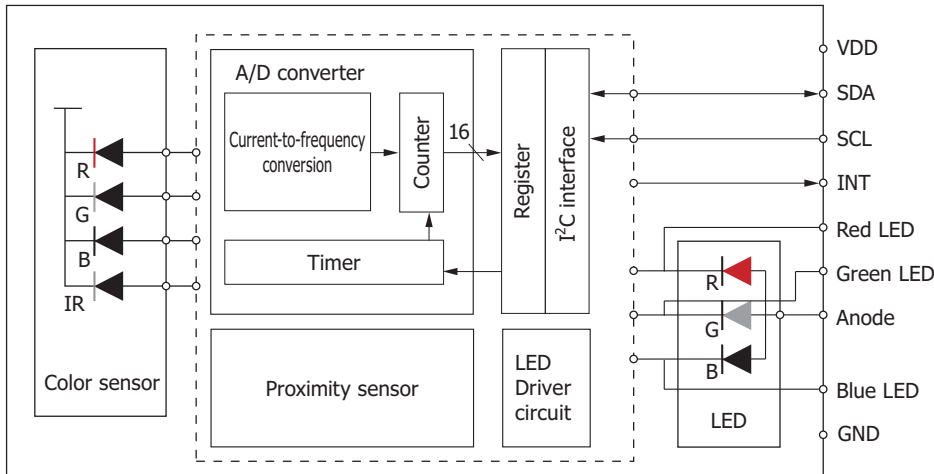

KPIC0206EA

Timing chart

■ Color sensor (manual mode)

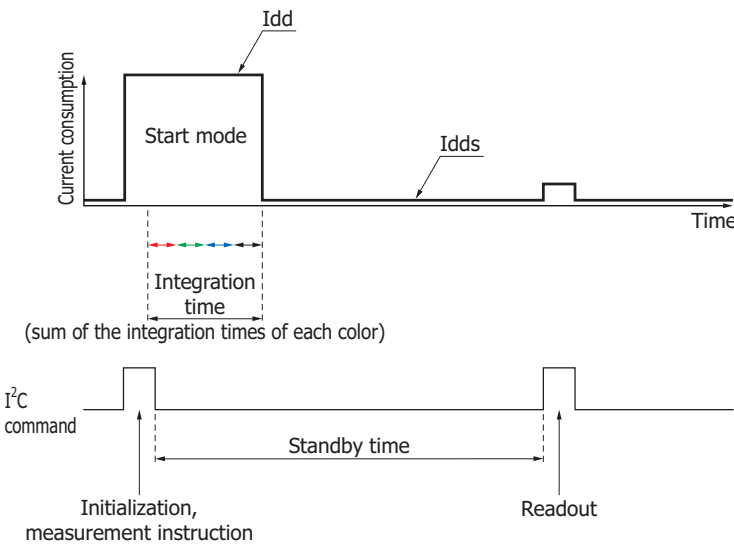

The color sensor only has a single ADC port. As such, photometry is performed consecutively for each color. The data of each color is stored temporarily in buffer registers (not the I²C register). After the completion of the infrared measurement, the entire set of data is stored in the I²C register. If this product is set to manual mode, after the integration time elapses, it will automatically switch to sleep mode. The integration time per cycle is the sum of the detection time of each color.

KPIC0214EA

■ Color sensor (fixed time mode)

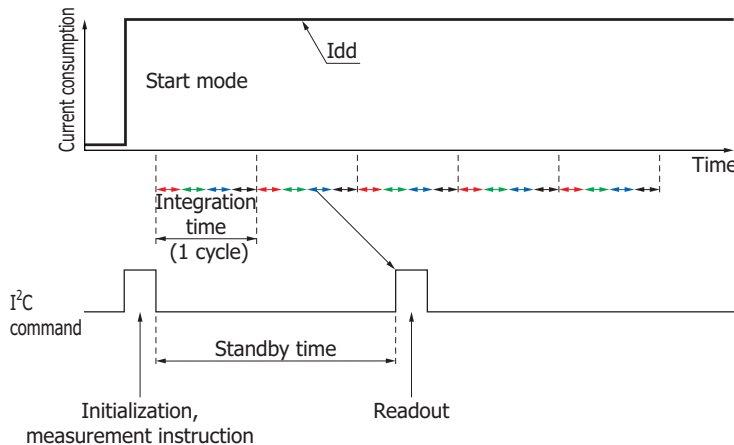

The measurement time is the shortest under the following conditions.

<Conditions>

- Fixed time mode, $T_{int}=00$ (32 μ s)
- Integration time: 32 μ s/color
- SCL frequency: 400 kHz

- Initialization measurement instruction: 135 μ s
- Standby time (>integration time): $32 \times 4=128 \mu$ s
- Readout: 274.5 μ s

Measurement time: 537.5 μ s

KPIC0215EA

■ Proximity sensor

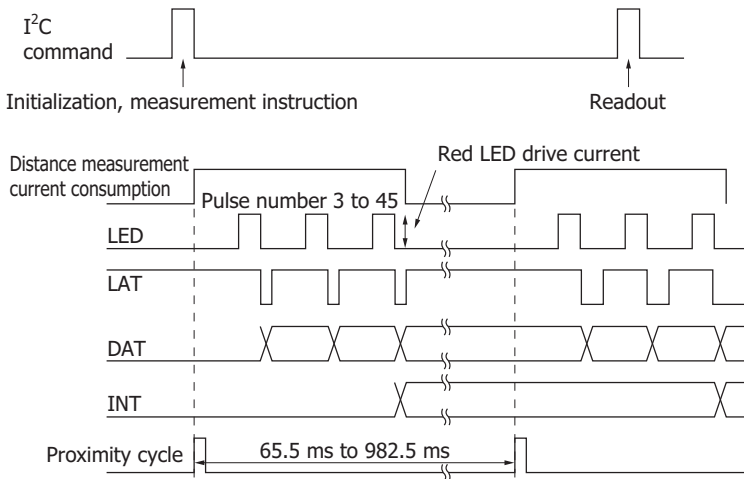

KPIC0216EA

In the proximity sensor, the light emission pulse count is designed to be adjustable in integer multiples of 3 from 3 to 45 in order to increase measurement precision. The interrupt signal (INT) is set to 1 only when all pulses are detected.

A red LED is used for light emission. The drive current can be changed in the range of 8 mA to 96 mA in 8-mA steps. The proximity cycle can be changed in the range of 65.5 ms to 982.5 ms in 65.5-ms steps. Measurement is performed every proximity cycle. When measurement is not performed, the sensor automatically switches to sleep mode.

■ 3-color LED driver

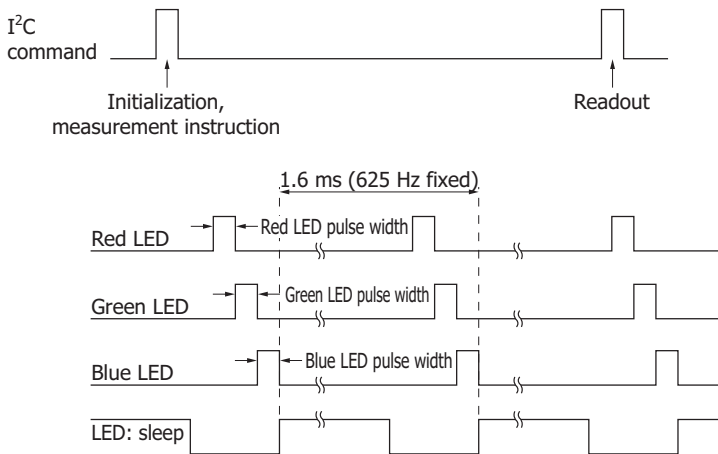

KPIC0217EA

The 3-color LED emits light in the order red, green, and blue. The light emission pulse width can be set in the range of 0 μ s to 240 μ s in 16- μ s steps (16 levels total). The light emission pulse width can be set for each color. The light emission cycle is fixed at approximately 1.6 ms, and the drive current is fixed at 8 mA.

If set to low current mode, the forward current of each color LED is set to 0.8 mA, which is 1/10 the initial setting. If set to DC mode, the drive current is set to direct current and can be set in the range of 8 mA to 120 mA in 8-mA steps. In DC mode, set the forward current to 30 mA or less for red and 20 mA or less for green and blue.

■ Connection example

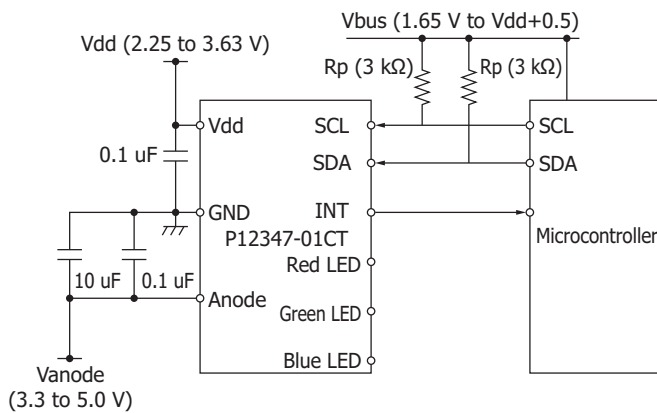

KPIC0218EA

Note: When the LED is emitting light or when the proximity sensor is in use, do not externally drive the LED. Set the LED's anode voltage to 3.3 V or higher.

Dimensional outline (unit: mm)

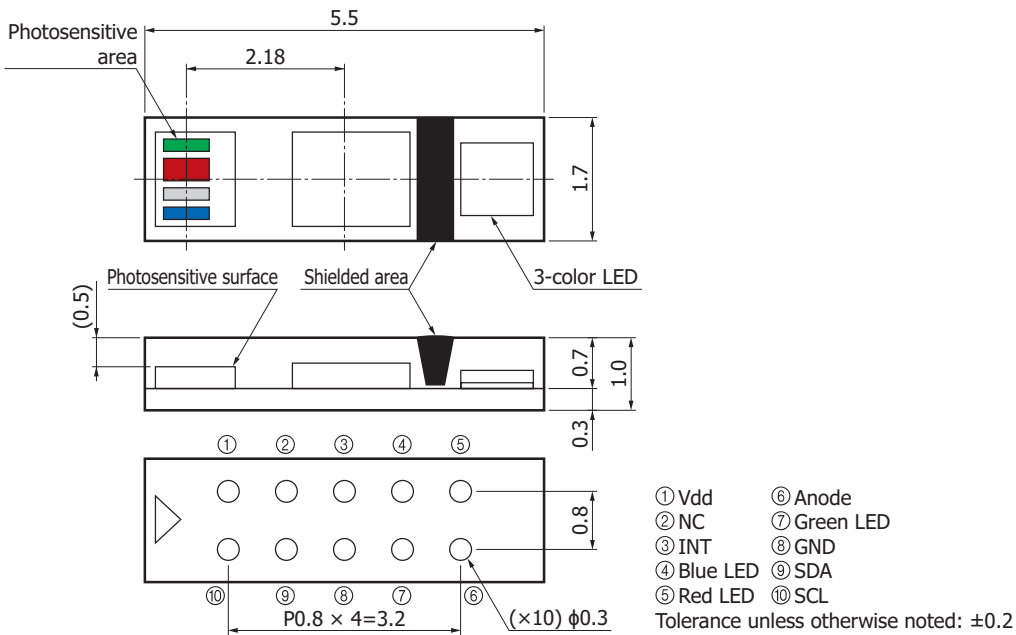

KPICA0098EA

Note: When using this product, contact us for technical information. Please check the technical information first, and then create an appropriate device design.

Enlarged view of photosensitive area (unit: mm)

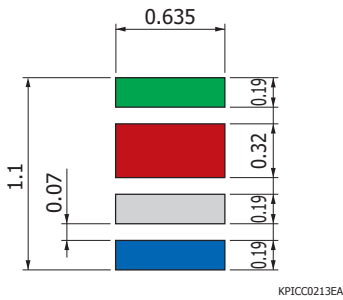

Recommended land pattern (unit: mm)

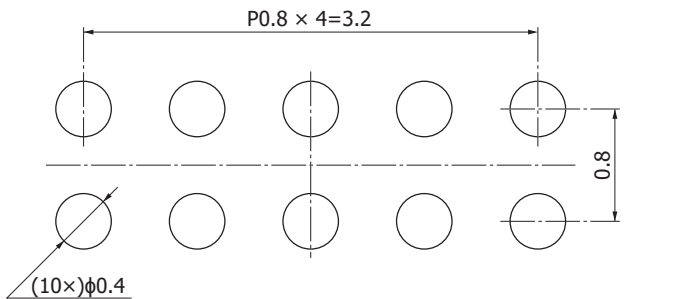

Standard packing specifications

■ Reel

Dimensions	Hub diameter	Tape width	Material	Electrostatic characteristics
180 mm	60 mm	12 mm	PS	Conductive

■ Embossed tape (unit: mm, material: PS, conductive)

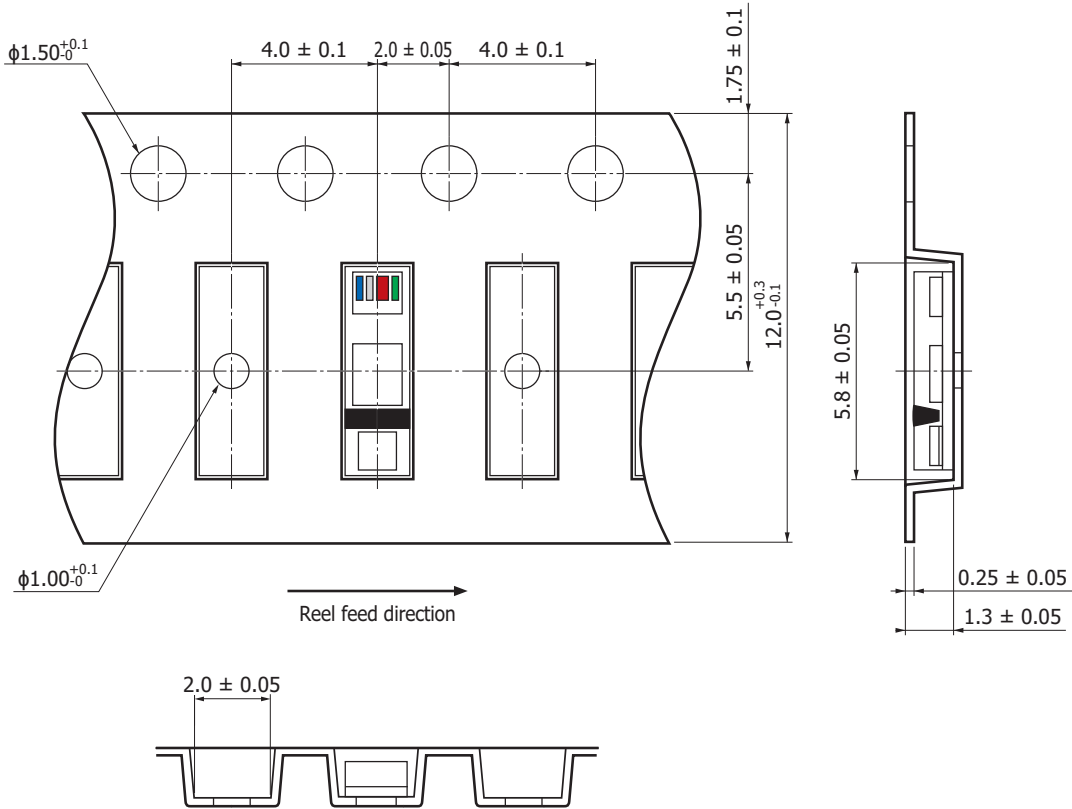

KPIC0219EA

■ Packing quantity

2000 pcs/reel

■ Packing type



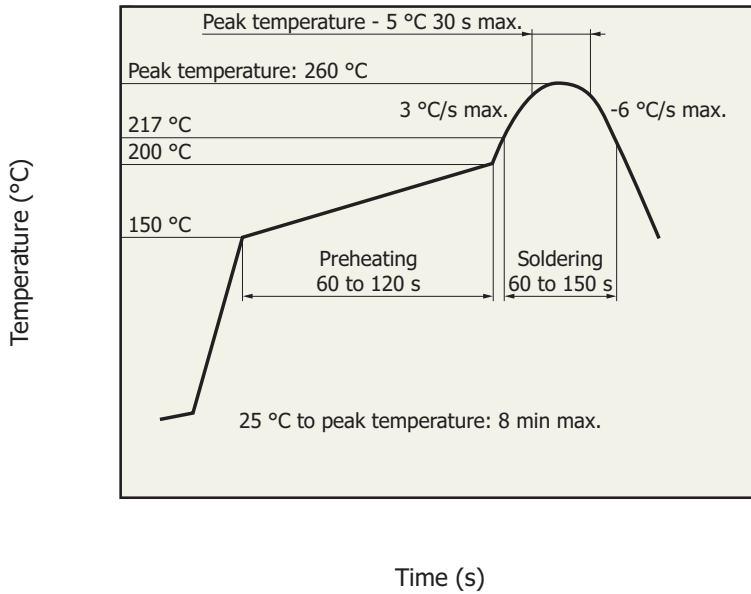











Reel and desiccant in moisture-proof packaging (vacuum-sealed)

Measured example of temperature profile with our hot-air reflow oven for product testing

KPICCO220EA

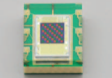
- This product supports lead-free soldering. After unpacking, store it in an environment at a temperature of 30 °C or less and a humidity of 60% or less, and perform soldering within 168 hours.
- The effect that the product receives during reflow soldering varies depending on the circuit board and reflow oven that are used. Before actual reflow soldering, check for any problems by testing out the reflow soldering methods in advance.

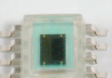
RGB color sensor lineup

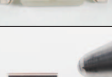
Type no.	Type	Photosensitive area (mm)	Package (mm)	Peak sensitivity wavelength (nm)	Photosensitivity				Photo		
S9032-02	Photodiode	 $\phi 2.0$	4 × 4.8 × 1.8 ^t 6 pin (filter 0.75 ^t)	B 460	B	0.18 (A/W) [$\lambda=460$ nm]					
				G 540	G	0.23 (A/W) [$\lambda=540$ nm]					
				R 620	R	0.16 (A/W) [$\lambda=620$ nm]					
S9702	Photodiode	 1.0 × 1.0	3 × 4 × 1.3 ^t 4 pin (filter 0.75 ^t)	B 460	B	0.18 (A/W) [$\lambda=460$ nm]					
				G 540	G	0.23 (A/W) [$\lambda=540$ nm]					
				R 620	R	0.16 (A/W) [$\lambda=620$ nm]					
S10917-35GT	Photodiode	 1.0 × 1.0	3 × 1.6 × 1.0 ^t COB (on-chip filter)	B 460	B	0.2 (A/W) [$\lambda=460$ nm]					
				G 540	G	0.23 (A/W) [$\lambda=540$ nm]					
				R 620	R	0.17 (A/W) [$\lambda=620$ nm]					
S10942-01CT	Photodiode	 1.0 × 1.0	3 × 1.6 × 1.0 ^t COB (on-chip filter)	*	B	0.21 (A/W) [$\lambda=460$ nm]					
					G	0.25 (A/W) [$\lambda=540$ nm]					
					R	0.45 (A/W) [$\lambda=620$ nm]					
S9706	Digital photo IC	 1.2 × 1.2	4 × 4.8 × 1.8 ^t 6 pin (filter 0.75 ^t)	B 465	Low	B	0.21 (LSB/lx)	High	B	1.9 (LSB/lx)	
				G 540		G	0.45 (LSB/lx)		G	4.1 (LSB/lx)	
				R 615		R	0.64 (LSB/lx)		R	5.8 (LSB/lx)	
S11012-01CR	Digital photo IC	 1.2 × 1.2	3.43 × 3.8 × 1.6 ^t COB (on-chip filter)	*	Low	B	0.3 (LSB/lx)	High	B	2.6 (LSB/lx)	
						G	0.6 (LSB/lx)		G	5.3 (LSB/lx)	
						R	1.4 (LSB/lx)		R	12.9 (LSB/lx)	
S11059-02DT /-03DS	I ² C compatible color sensor	 0.56 × 1.22	3 × 4.2 × 1.3 ^t 10 pin (on-chip filter)	B 460	Low	B	4.4 (count/lx)	High	B	44.8 (count/lx)	
				G 530		G	8.3 (count/lx)		G	85.0 (count/lx)	
				R 615		R	11.2 (count/lx)		R	117.0 (count/lx)	
				IR 855		IR	3.0 (count/lx)		IR	30.0 (count/lx)	
S13683-02WT	I ² C compatible color sensor	 1.22 × 0.56	1.75 × 1.25 × 0.48 ^t WL-CSP (on-chip filter)	R 615	Low	R	9.48 (count/lx)	High	R	94.5 (count/lx)	
				G 530		G	7.61 (count/lx)		G	76.2 (count/lx)	
				B 460		B	3.35 (count/lx)		B	31.7 (count/lx)	
				IR 855		IR	1.66 (count/lx)		IR	15.3 (count/lx)	

* Refer to the spectral response of each product's datasheet.

Related information

www.hamamatsu.com/sp/ssd/doc_en.html

Precautions

- Disclaimer
- Surface mount type products

Information described in this material is current as of August 2017.

Product specifications are subject to change without prior notice due to improvements or other reasons. This document has been carefully prepared and the information contained is believed to be accurate. In rare cases, however, there may be inaccuracies such as text errors. Before using these products, always contact us for the delivery specification sheet to check the latest specifications.

The product warranty is valid for one year after delivery and is limited to product repair or replacement for defects discovered and reported to us within that one year period. However, even if within the warranty period we accept absolutely no liability for any loss caused by natural disasters or improper product use. Copying or reprinting the contents described in this material in whole or in part is prohibited without our prior permission.

HAMAMATSU

www.hamamatsu.com

HAMAMATSU PHOTONICS K.K., Solid State Division

1126-1 Ichino-cho, Higashi-ku, Hamamatsu City, 435-8558 Japan, Telephone: (81) 53-434-3311, Fax: (81) 53-434-5184

U.S.A.: Hamamatsu Corporation: 360 Foothill Road, Bridgewater, N.J. 08807, U.S.A., Telephone: (1) 908-231-0960, Fax: (1) 908-231-1218

Germany: Hamamatsu Photonics Deutschland GmbH: Arzbergerstr. 10, D-82211 Herrsching am Ammersee, Germany, Telephone: (49) 8152-375-0, Fax: (49) 8152-265-8

France: Hamamatsu Photonics France S.A.R.L.: 19, Rue du Saule Trapu, Parc du Moulin de Massy, 91882 Massy Cedex, France, Telephone: 33-(1) 69 53 71 00, Fax: 33-(1) 69 53 71 10

United Kingdom: Hamamatsu Photonics UK Limited: 2 Howard Court, 10 Tewin Road, Welwyn Garden City, Hertfordshire AL7 1BW, United Kingdom, Telephone: (44) 1707-294888, Fax: (44) 1707-325777

North Europe: Hamamatsu Photonics Norden AB: Torshamnsgatan 35 16440 Kista, Sweden, Telephone: (46) 8-509-031-00, Fax: (46) 8-509-031-01

Italy: Hamamatsu Photonics Italia S.r.l.: Strada della Moia, 1 int. 6, 20020 Arese (Milano), Italy, Telephone: (39) 02-93581733, Fax: (39) 02-93581741

China: Hamamatsu Photonics (China) Co., Ltd.: B1201, Jiaming Center, No.27 Dongsanhuan Beilu, Chaoyang District, Beijing 100020, China, Telephone: (86) 10-6586-6006, Fax: (86) 10-6586-2866