

DETAILS

Product Number	C13299_STRADA-2X2-ME
Family	Strada
Type	Lens array
Color	clear
Diameter	50 + 50 mm
Height	7,1 mm
Style	square
Optic Material	PMMA
Holder Material	
Fastening	glue, pin, screw
Status	production ready
ROHS Compliant	Yes
Date Updated	2/11/2016



OPTICAL PROPERTIES

LED	Viewing Angle	Light Beam	Efficiency	cd/lm	Connector
XT-E	Asymmetric deg	Streetligh...	94 %	1.000	-
XM-L	Asymmetric deg	Streetligh...	94 %	0.700	-
XB-D	Asymmetric deg	Streetligh...	94 %	1.150	-
XP-G2	Asymmetric deg	Streetligh...	94 %	1.100	-
XP-G	Asymmetric deg	Streetligh...	94 %	1.000	-
XQ-E	sim: Asymmetri	Streetligh...	sim: 90 %	-	-
XP-E2	Asymmetric deg	Streetligh...	94 %	1.300	-
XM-L2	asymmetric deg	Streetligh...	94 %	0.700	-
XB-H	sim: Asymmetri	Streetligh...	sim: 91 %	-	-
XP-L	Asymmetric deg	Streetligh...	94 %	0.720	-
XP-L HI	asymmetric deg	Streetligh...	94 %	1.000	-
XHP35 HD	sim: Asymmetri	Streetligh...	sim: 90 %	-	-
XHP35 HI	sim: Asymmetri	Streetligh...	sim: 92 %	-	-
XP-G3	sim: asym	Streetligh...	sim: 90 %	sim: 0.700	-
XP-L2	Asymmetric deg	Streetligh...	94 %	0.630	-
H35C1 (LEMWA33)	Asymmetric deg	Streetligh...	94 %	0.900	-
LUXEON R	Asymmetric deg	Streetligh...	94 %	0.900	-
LUXEON Rebel ES	Asymmetric deg	Streetligh...	94 %	1.000	-
LUXEON T	asymmetric deg	Streetligh...	94 %	0.970	-
LUXEON Z ES	Asymmetric deg	Streetligh...	94 %	1.400	-
LUXEON Q	asymmetric deg	Streetligh...	94 %	1.000	-
LUXEON H50-2	sim: Asymmetri	Streetligh...	-	-	-
LUXEON MZ	asymmetric deg	Streetligh...	94 %	0.700	-
LUXEON TX	asymmetric deg	Streetligh...	94 %	0.960	-
LUXEON 5050	Asymmetric deg	Streetligh...	94 %	0.570	-



PRODUCT DATASHEET

Strada series

last update 2/11/2016

OPTICAL PROPERTIES

LED	Viewing Angle	Light Beam	Efficiency	cd/lm	Connector
NS9x383	Asymmetric deg	Streetligh...	94 %	0.600	-
NVSxx19B/NVSxx19C	asymmetric deg	Streetligh...	94 %	0.900	-
NWSx229A	Asymmetric deg	Streetligh...	94 %	0.620	-
NVSW3x9A	Asymmetric deg	Streetligh...	94 %	0.770	-
Oslon Square PC	Asymmetric deg	Streetligh...	94 %	1.000	-
Duris S8	sim: Asymmetric	Streetligh...	sim: 92 %	sim: 0.630	-
Oslon Square Gen3	Asymmetric deg	Streetligh...	94 %	0.980	-
Duris P8	sim: Asymmetric	Streetligh...	sim: 92 %	sim: 0.740	-
Fortimo FastFlex LED board 2x8 DA G4	Asymmetric deg	Streetligh...	94 %	1.100	-
LH351B	Asymmetric deg	Streetligh...	94 %	0.740	-
LH351D	Asymmetric deg	Streetligh...	94 %	0.590	-
LH351C	Asymmetric deg	Streetligh...	94 %	0.700	-
LH508A	Asymmetric deg	Streetligh...	94 %	0.530	-
Z5P	Asymmetric deg	Streetligh...	94 %	1.000	-
Acrich MJT 4040	Asymmetric deg	Streetligh...	94 %	0.800	-
Z5M	Asymmetric deg	Streetligh...	94 %	1.000	-
Z5M1/Z5M2	asymmetric deg	Streetligh...	94 %	0.800	-
Z8Y22P	Asymmetric deg	Streetligh...	94 %	0.840	-
TL1L3	Asymmetric deg	Streetligh...	94 %	0.680	-
TL1L4	Asymmetric deg	Streetligh...	91 %	0.880	-
RLE G1 49x223mm 4000lm xxx EXC OT	Asymmetric deg	Streetligh...	94 %	1.100	-
RLE G1 49x245mm 4000lm xxx EXC OT	Asymmetric deg	Streetligh...	94 %	1.100	-
RLE G1 49x121mm 2000lm xxx EXC OT	Asymmetric deg	Streetligh...	94 %	1.100	-
RLE G1 49x133mm 2000lm xxx EXC OT	Asymmetric deg	Streetligh...	94 %	1.100	-

D C B A

4

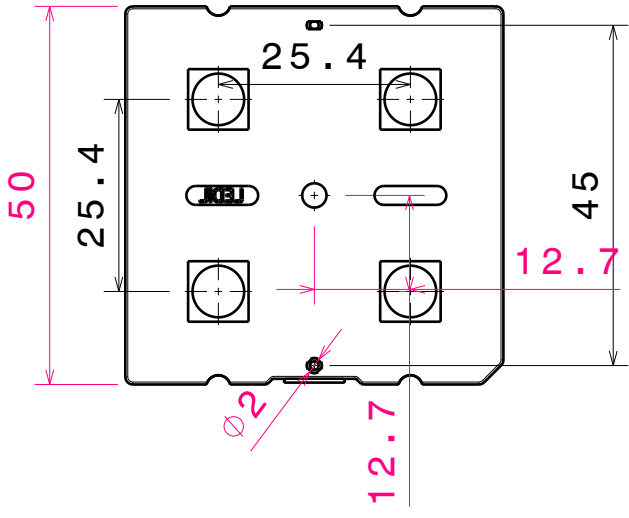

Bottom view

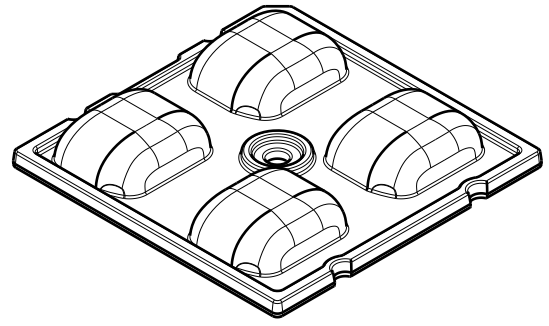

Isometric view

3

Beam Direction

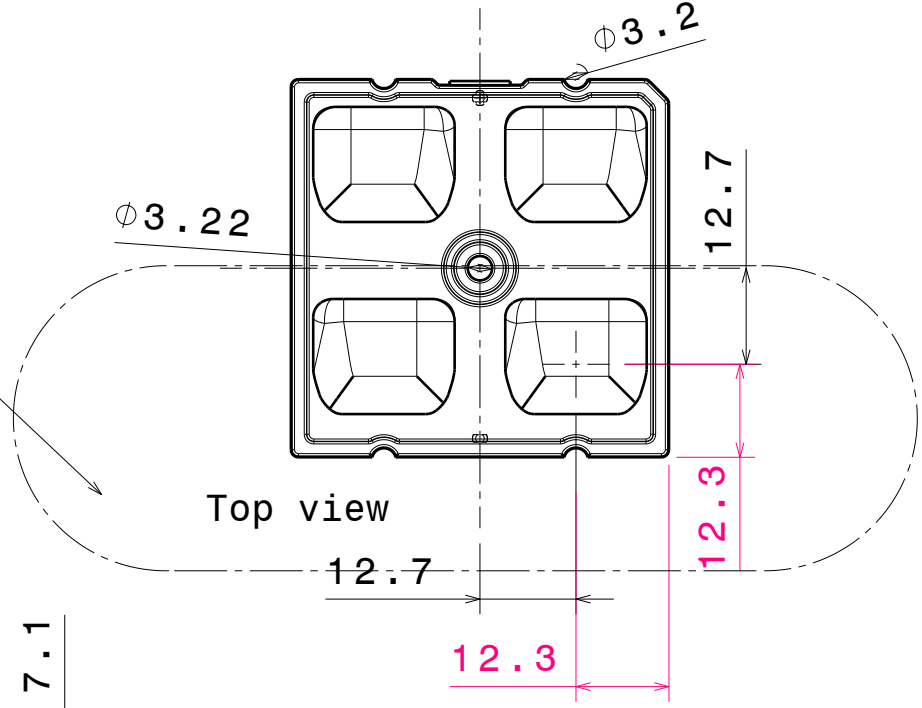

Top view

2

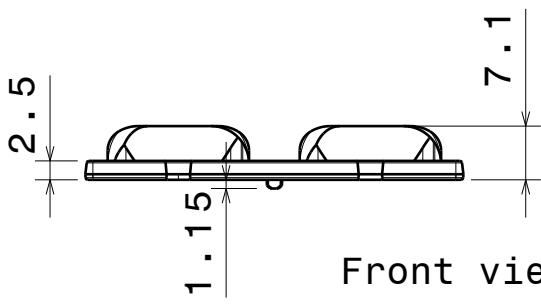

Front view

INDEX	PART NO	DESCRIPTION	MATERIAL	COLOUR
1	C13299	STRADA-2X2-ME	PMMA 8N	TRANSPARENT

Tolerances if not otherwise shown
According to DIN ISO 2768-1
Linear measures:
Up to 30mm class M, otherwise class C.
According to DIN ISO 2768-2
Form and position: class L

LEDiL LediL Oy
Salorankatu 10
FIN 24240 SALO
Finland

THIRD ANGLE PROJECTION:

DRAWING TITLE
C13299_STRADA-2X2-ME

This drawing is the property of LEDiL Oy. It may not be reproduced, copied or communicated without a written agreement with LEDiL Oy."

SIZE	PART NUMBER
A4	C13299

SCALE	1:1	WEIGHT	SHEET	1/1
-------	-----	--------	-------	-----

1

1

D A

Luminaire: LEDiL Oy C13299_STRADA-2X2-ME_(XT-E)_3 Eff.94.0%
Lamps: 1 x CREE_XT-E_385.199lm@250mA_CCT=5717K

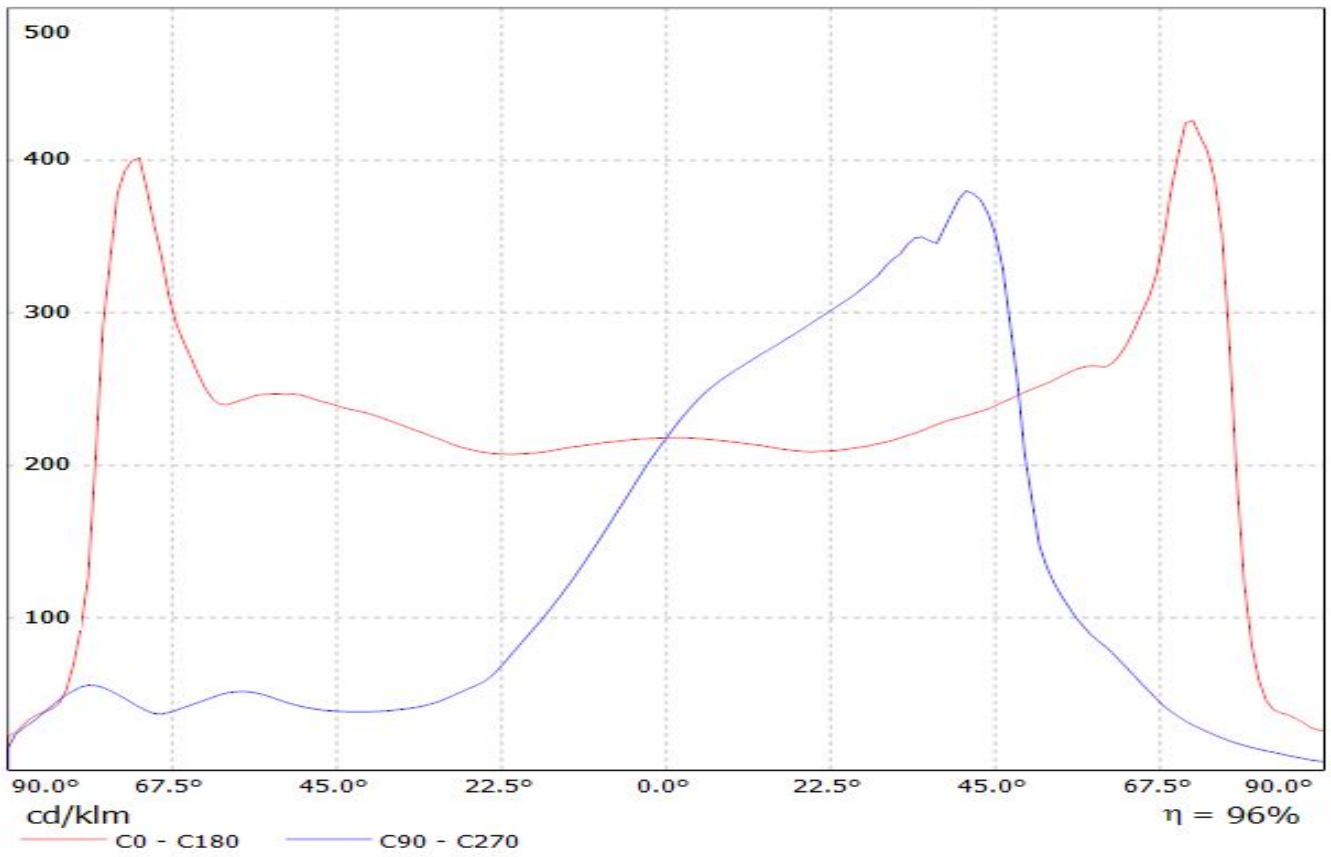

LEDiL Oy C13299_STRADA-2X2-ME_(XM-L) Eff.94.0% / LDC (Linear)

Luminaire: LEDiL Oy C13299_STRADA-2X2-ME_(XM-L) Eff.94.0%
Lamps: 1 x XM-L_2x2_360.4lm@250mA_P=2.82462W_I=249.9mA

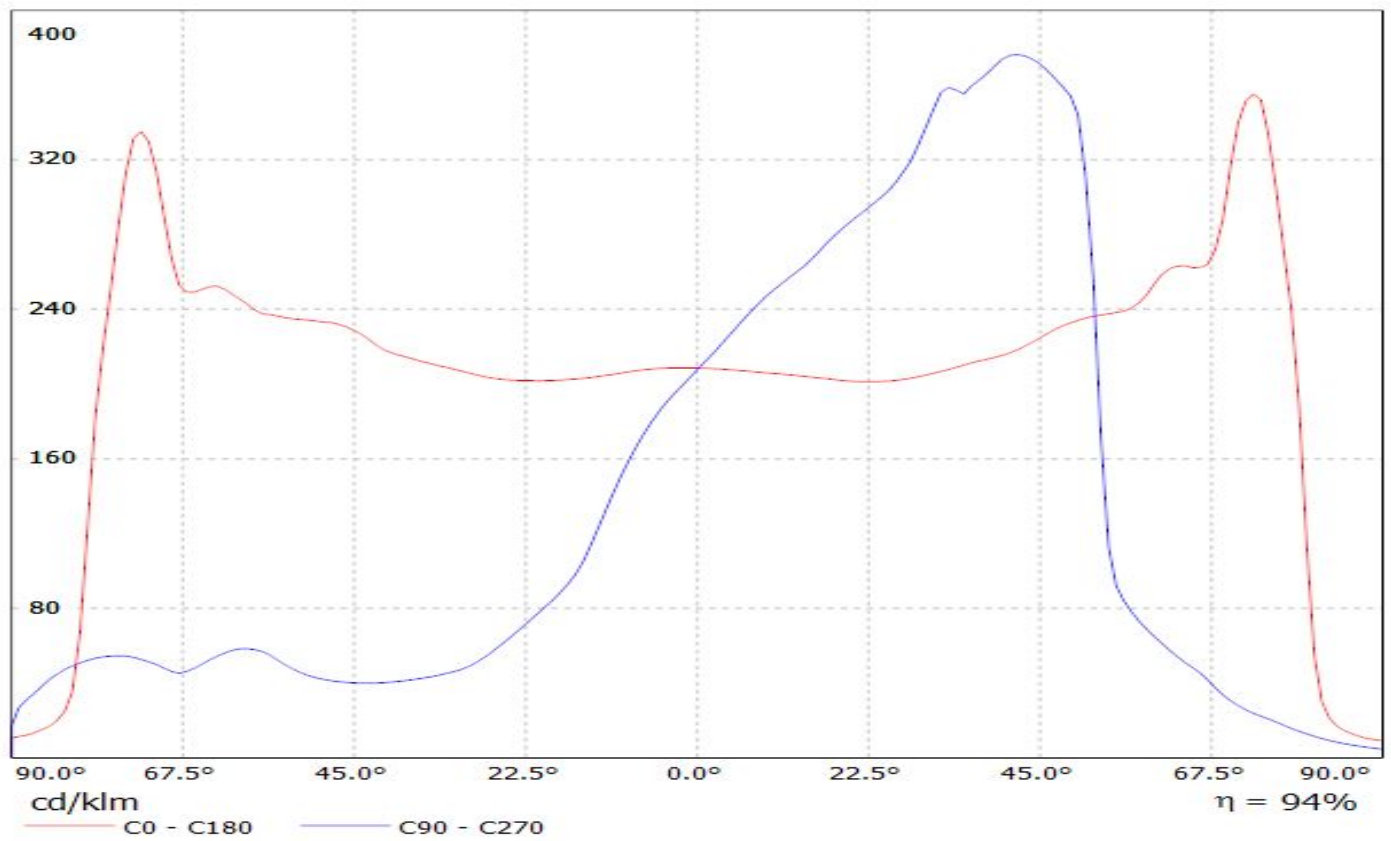

LEDiL Oy C13299_STRADA-2X2-ME_(XB-D) Eff.94.0% / LDC (Linear)

Luminaire: LEDiL Oy C13299_STRADA-2X2-ME_(XB-D) Eff.94.0%
Lamps: 1 x XB-D_2x2_368.85lm@250mA_P=3.06227W_I=249.9mA

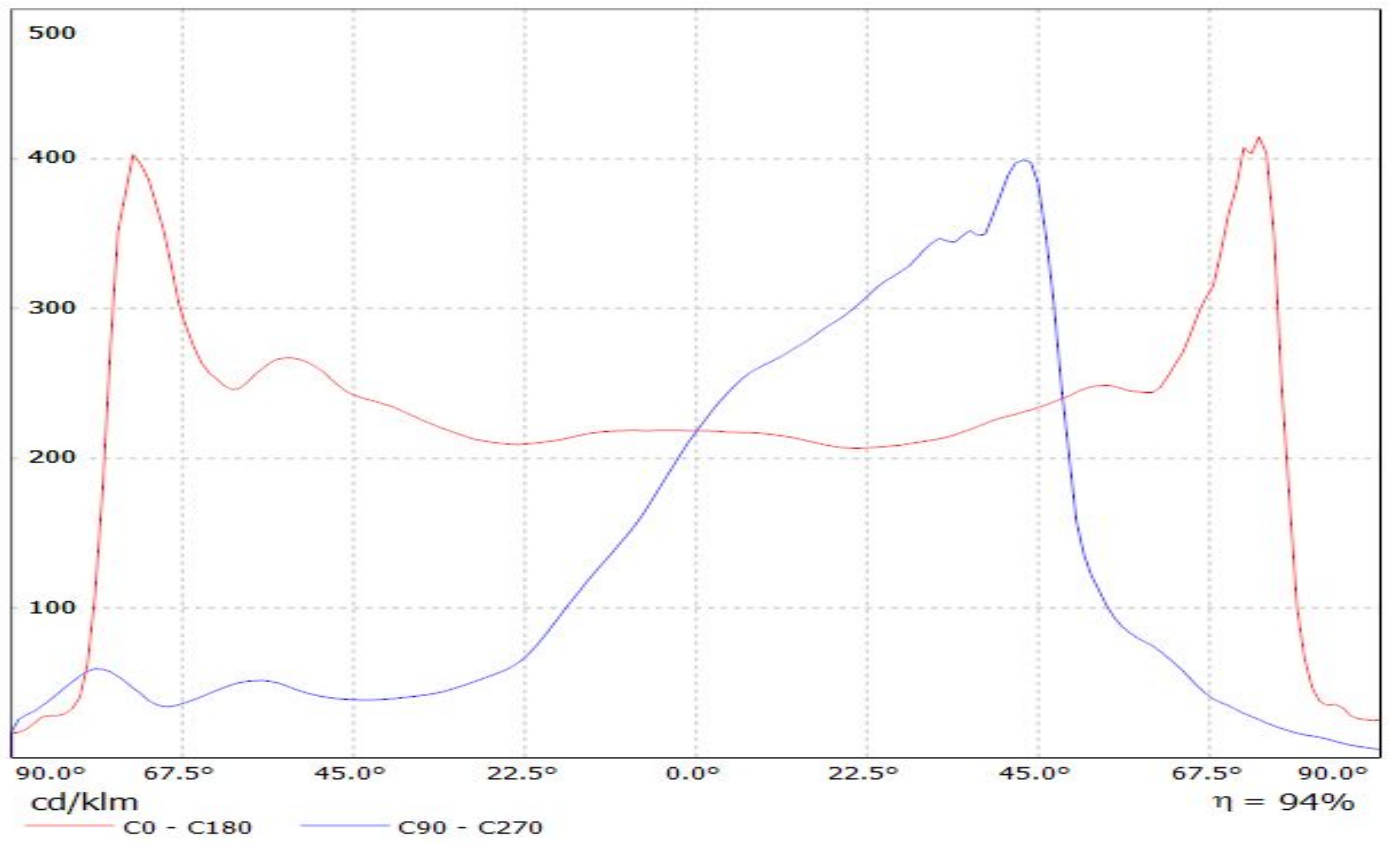

LEDiL Oy C13299_STRADA-2X2-ME_(XP-G2) Eff.94.0% / LDC (Linear)

Luminaire: LEDiL Oy C13299_STRADA-2X2-ME_(XP-G2) Eff.94.0%
Lamps: 1 x XP-G2_2x2_(XPGBWT-L1-000-00G51)
_418.9lm@250mA_CCT=7181K_P=2.93358W_I=249.9mA

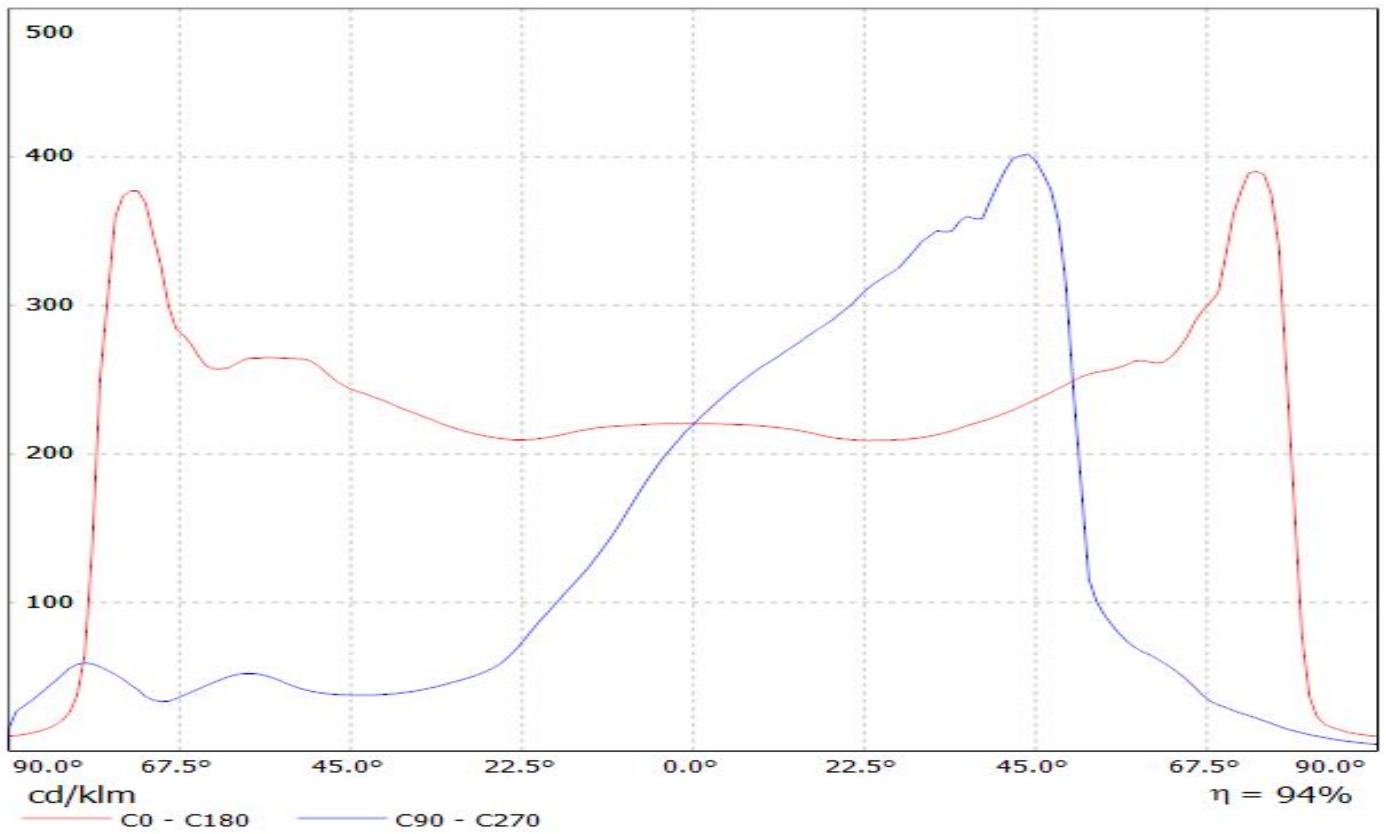

LEDiL Oy C13299_STRADA-2X2-ME_(XP-G) / LDC (Linear)

Luminaire: LEDiL Oy C13299_STRADA-2X2-ME_(XP-G)

Lamps: 1 x XP-G_2x2_258.35lm@250mA_P=2.88734W_I=249.9mA

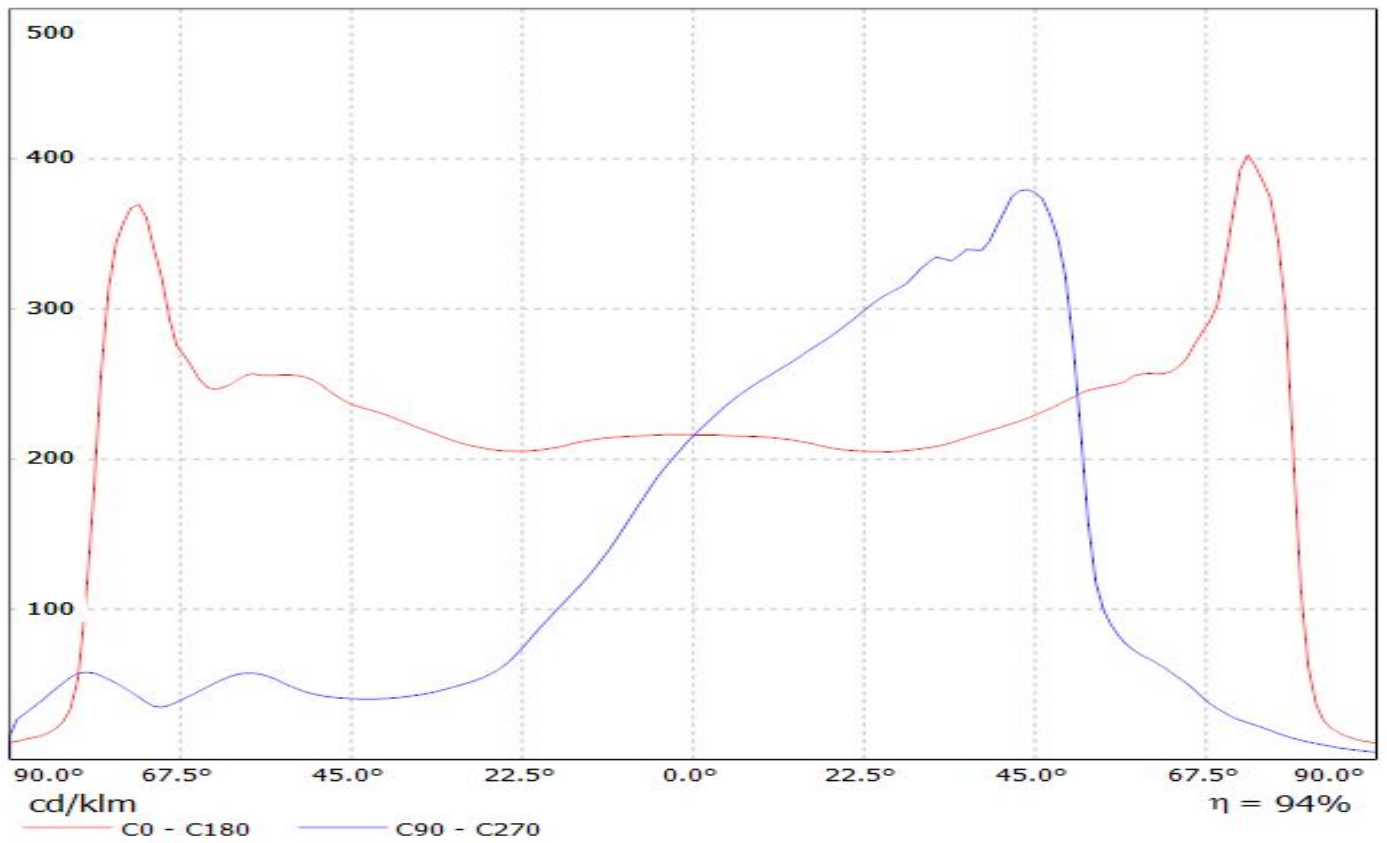

LEDiL Oy C13299_STRADA-2X2-ME_(XP-E2) Eff.94.0% / LDC (Linear)

Luminaire: LEDiL Oy C13299_STRADA-2X2-ME_(XP-E2) Eff.94.0%

Lamps: 1 x CREE_XP-E2_2x2_(XPEBWT-L1-7B4-Q4-0-01)

_341.05lm@250mA_P=2.92366W_I=249.8mA

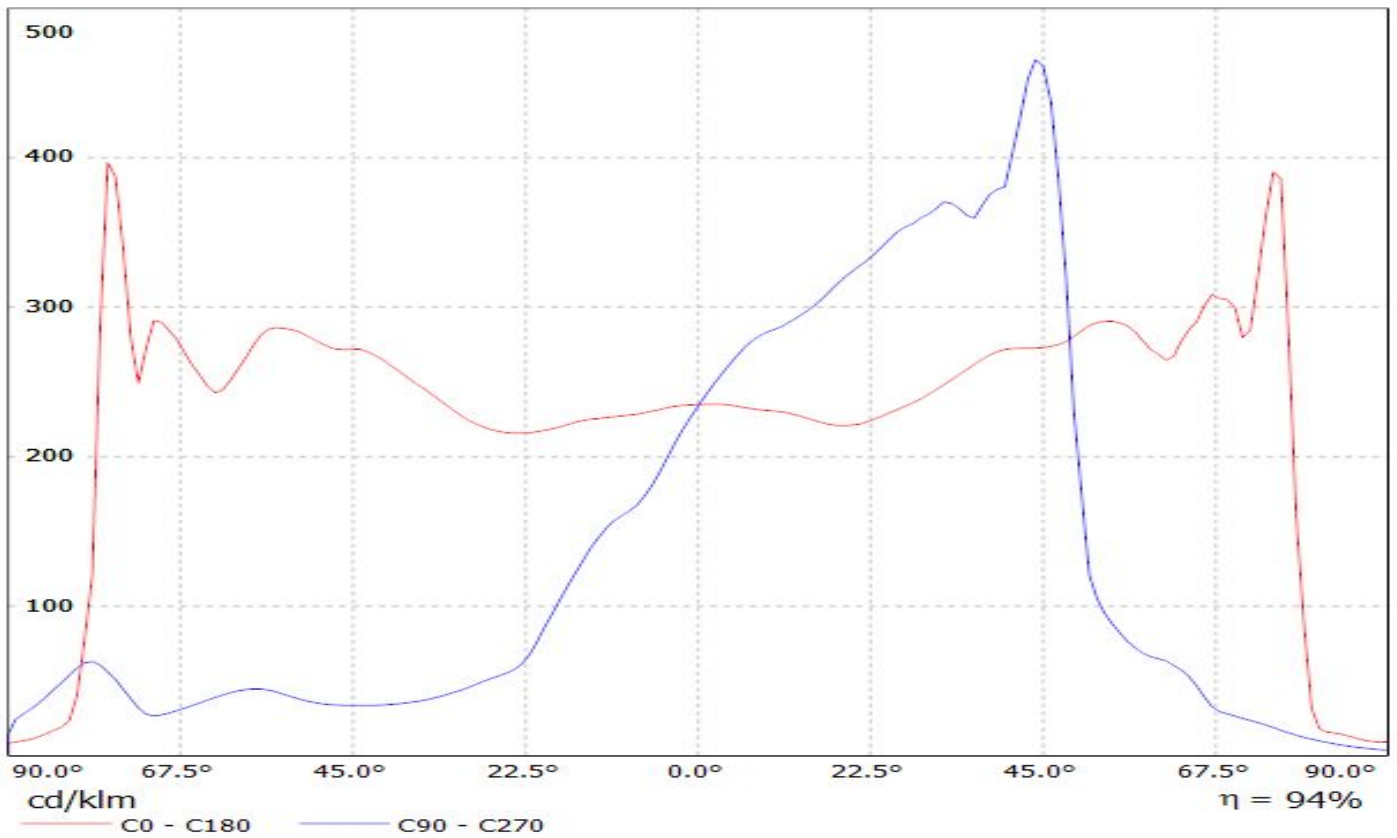

Luminaire: LEDil Oy C13299_STRADA-2X2-ME_(XM-L2) Efficiency=94%
Lamps: 1 x Cree XM-L2 (XMLBWT-0-7B4-T30-0L-0001) 356lm @ 250mA CCT=3200K P=2.8W I=250mA

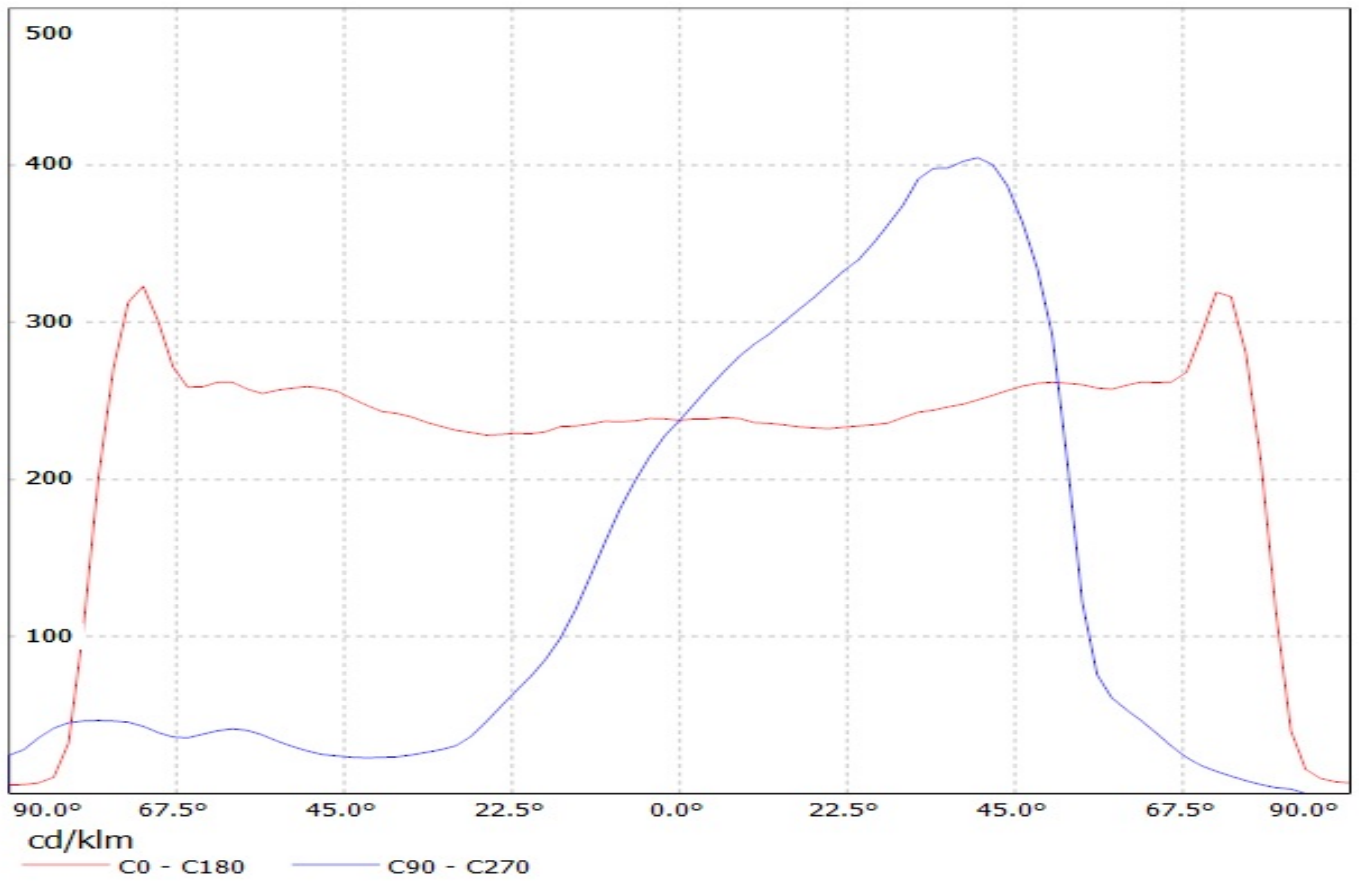

Luminaire: LEDiL Oy C13299_STRADA-2X2-ME_(XP-L)

Lamps: 1 x CREE_XP-L_2x2_(XPLAWT-0-1B0-V40-00-0001)_518.95lm@250mA_CCT=7600K_P=2.79963W_I=249.9mA

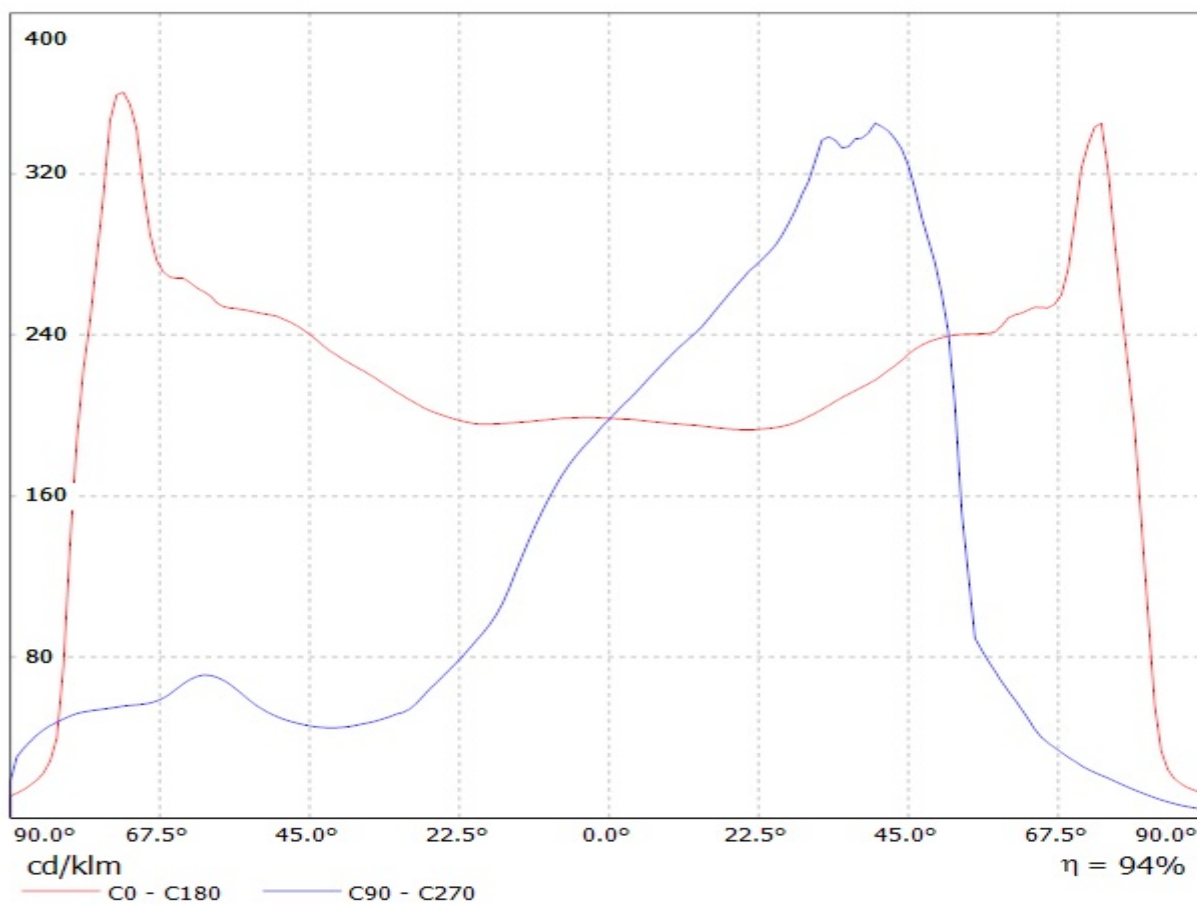

Luminaire: LEDiL Oy C13299_STRADA-2X2-ME_(XP-L_HI)
Lamps: 1 x Cree_XP-L_HI_(2x2)_(XPLAWT-H-5A3-U60-013-0001)
_455.077lm@250mA_P=2.84011W_I=0.2499A

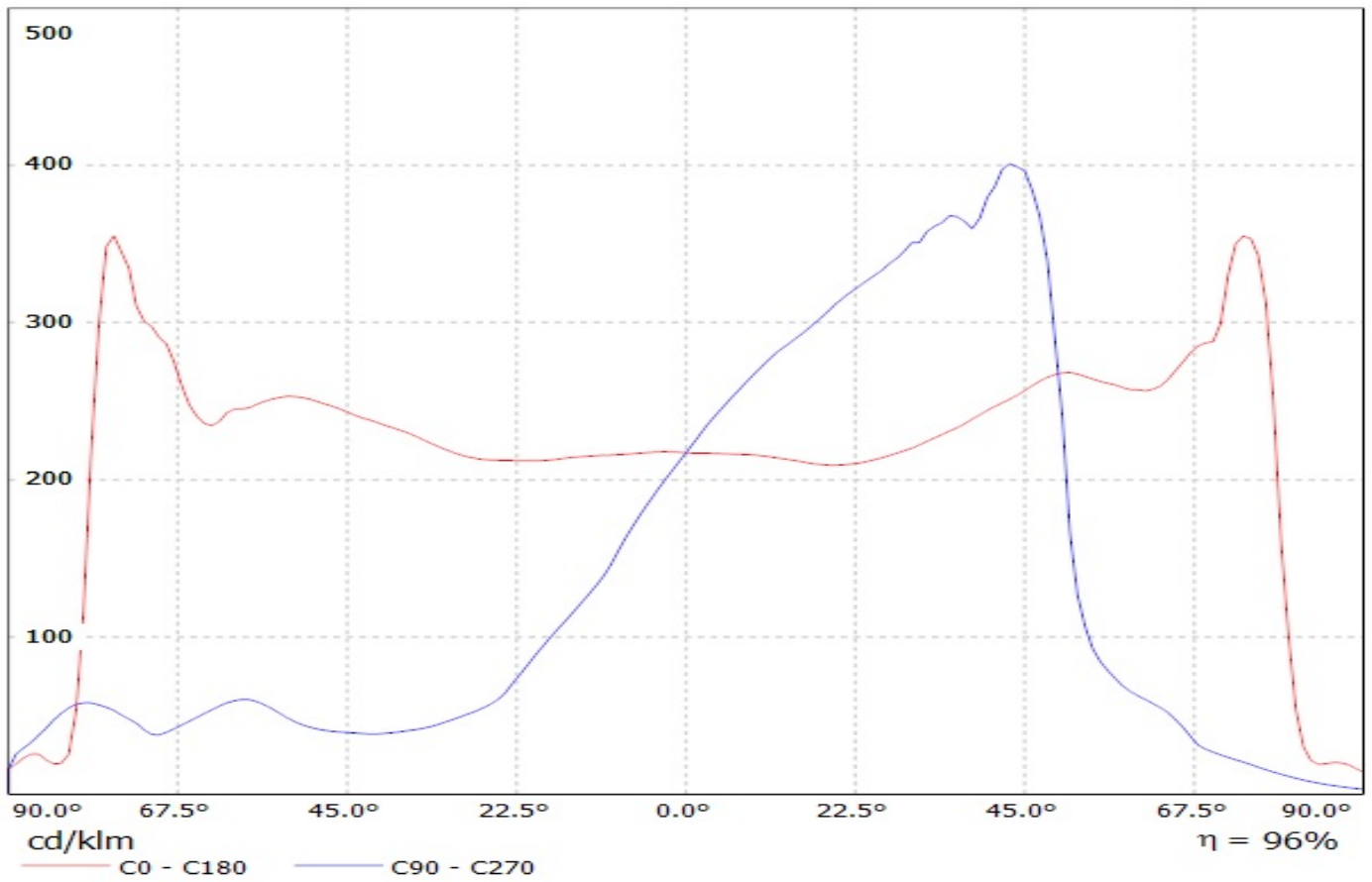

Luminaire: Ledil Oy C13299_STRADA-2X2-ME_CREE_XP-G3_SIMULATED
Lamps: 1 x CREE XP-G3

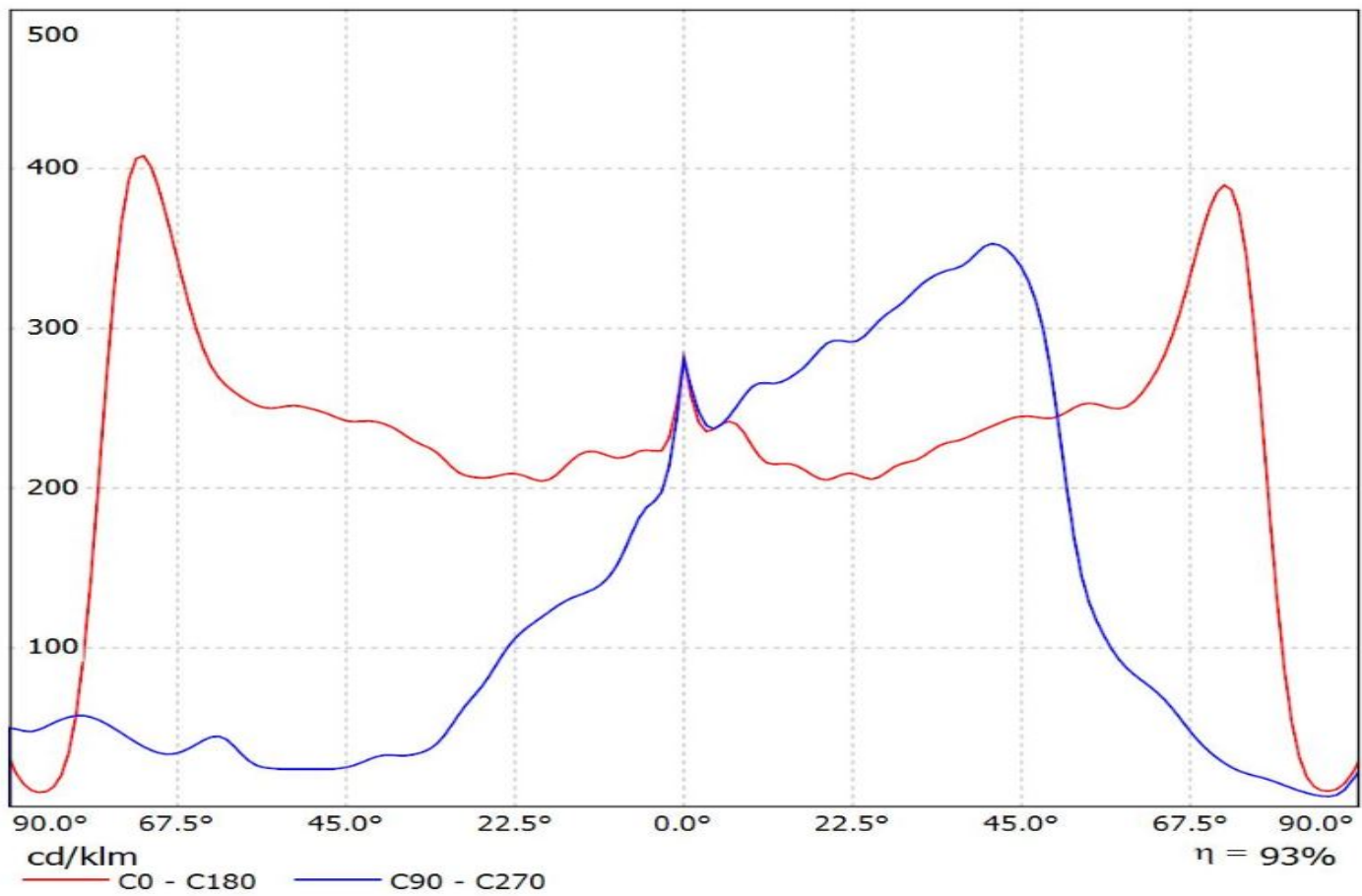

Luminaire: Ledil C13299_STRADA-2X2-ME_(XP-L2)

Lamps: 1 x Cree_XP-L2_2x2_(XPLBWT-00-0000-000BV50E3)550.93lm@250mA_P=2.7815W_I=0.25A

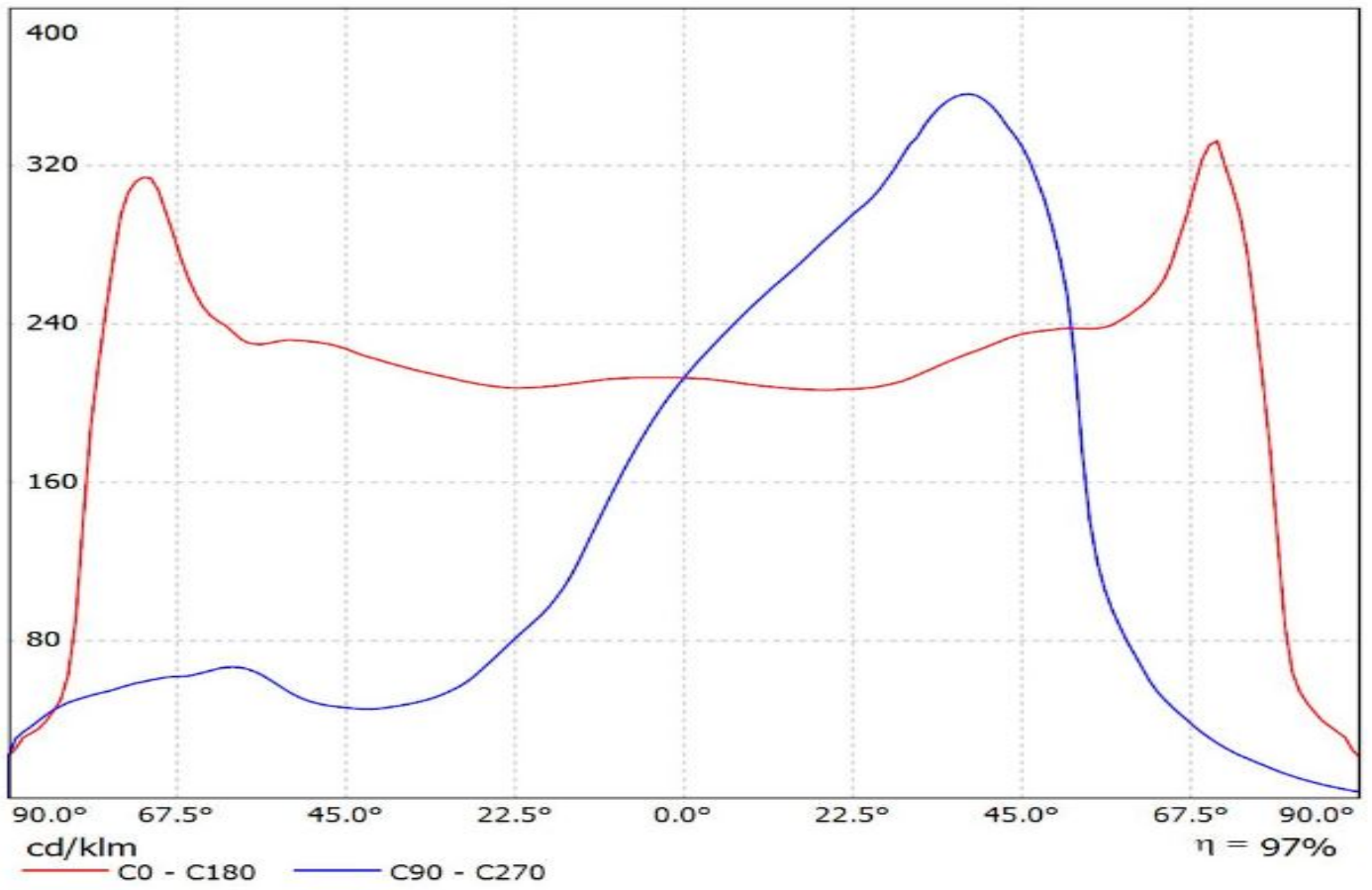

**LEDiL Oy C13299_STRADA-2X2-ME_(LG-3535-CERAMIC-GEN2) Eff.94.0% /
LDC (Linear)**

Luminaire: LEDiL Oy C13299_STRADA-2X2-ME_(LG-3535-CERAMIC-GEN2) Eff.94.0%
Lamps: 1 x LG-3535-CERAMIC-GEN2_2x2_475.9lm@250mA_P=2.8651W_CCT=6562K_I=249.9mA

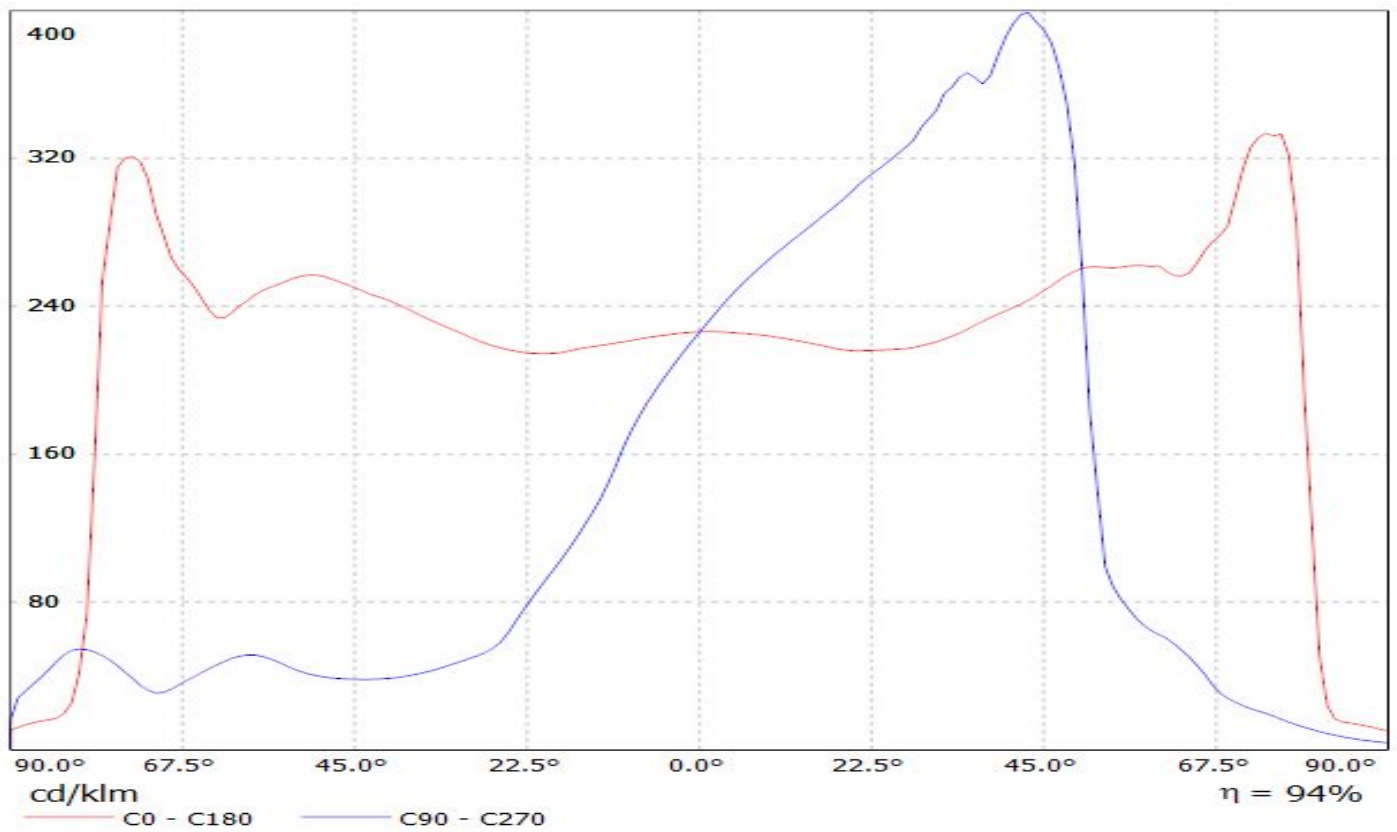

LEDiL Oy C13299_STRADA-2X2-ME_(Luxeon-R) Eff.94.0% / LDC (Linear)

Luminaire: LEDiL Oy C13299_STRADA-2X2-ME_(Luxeon-R) Eff.94.0%

Lamps: 1 x Luxeon_R_2x2_(LXA7-PW30)_314.75lm@250mA_P=2.77914W_I=249.9mA

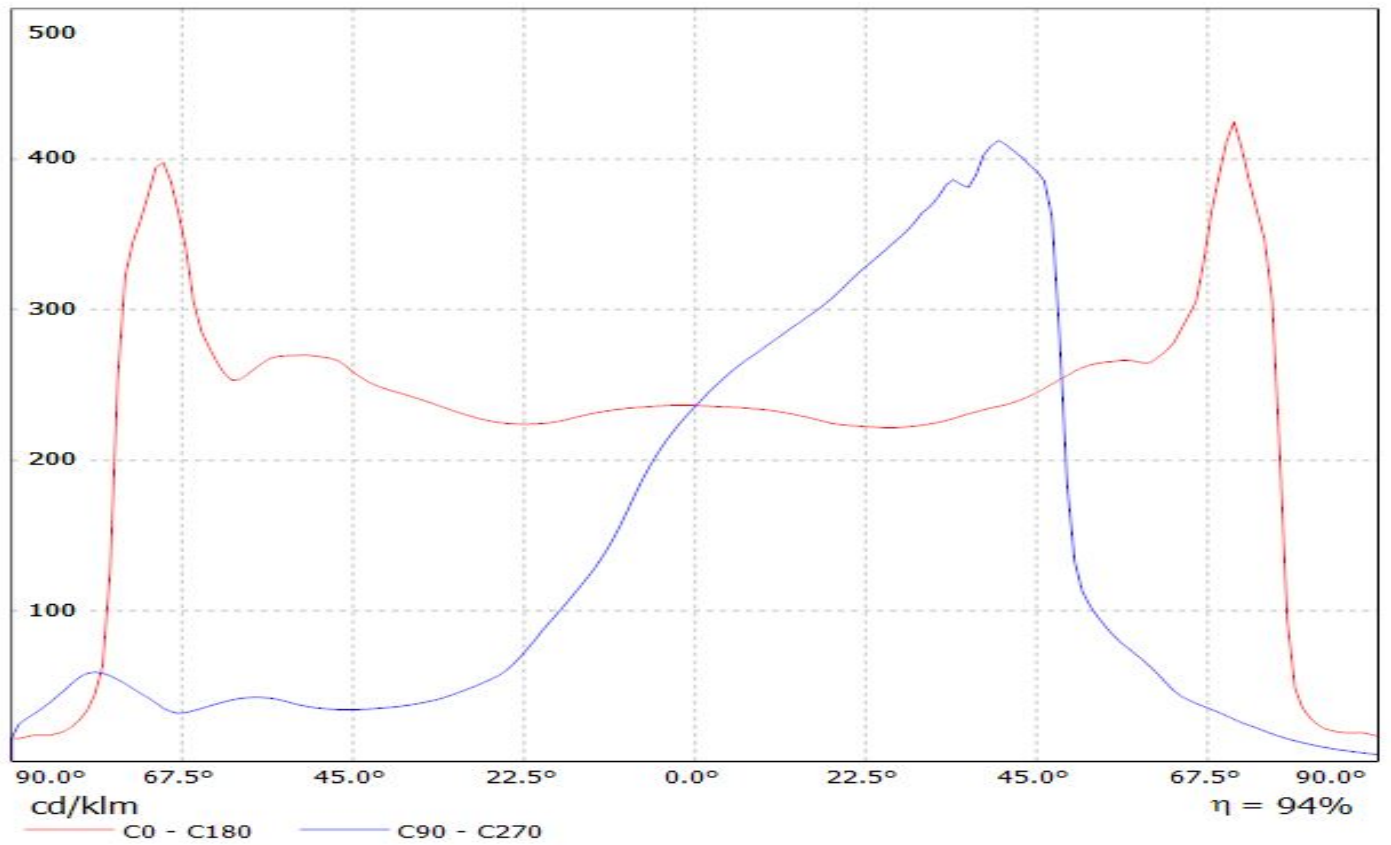

LEDiL Oy C13299_STRADA-2X2-ME_(Rebel-ES) Eff.94.0% / LDC (Linear)

Luminaire: LEDiL Oy C13299_STRADA-2X2-ME_(Rebel-ES) Eff.94.0%
Lamps: 1 x Luxeon_Rebel-ES_2x2_341.5lm@250mA_P=2.86485W_I=249.9mA

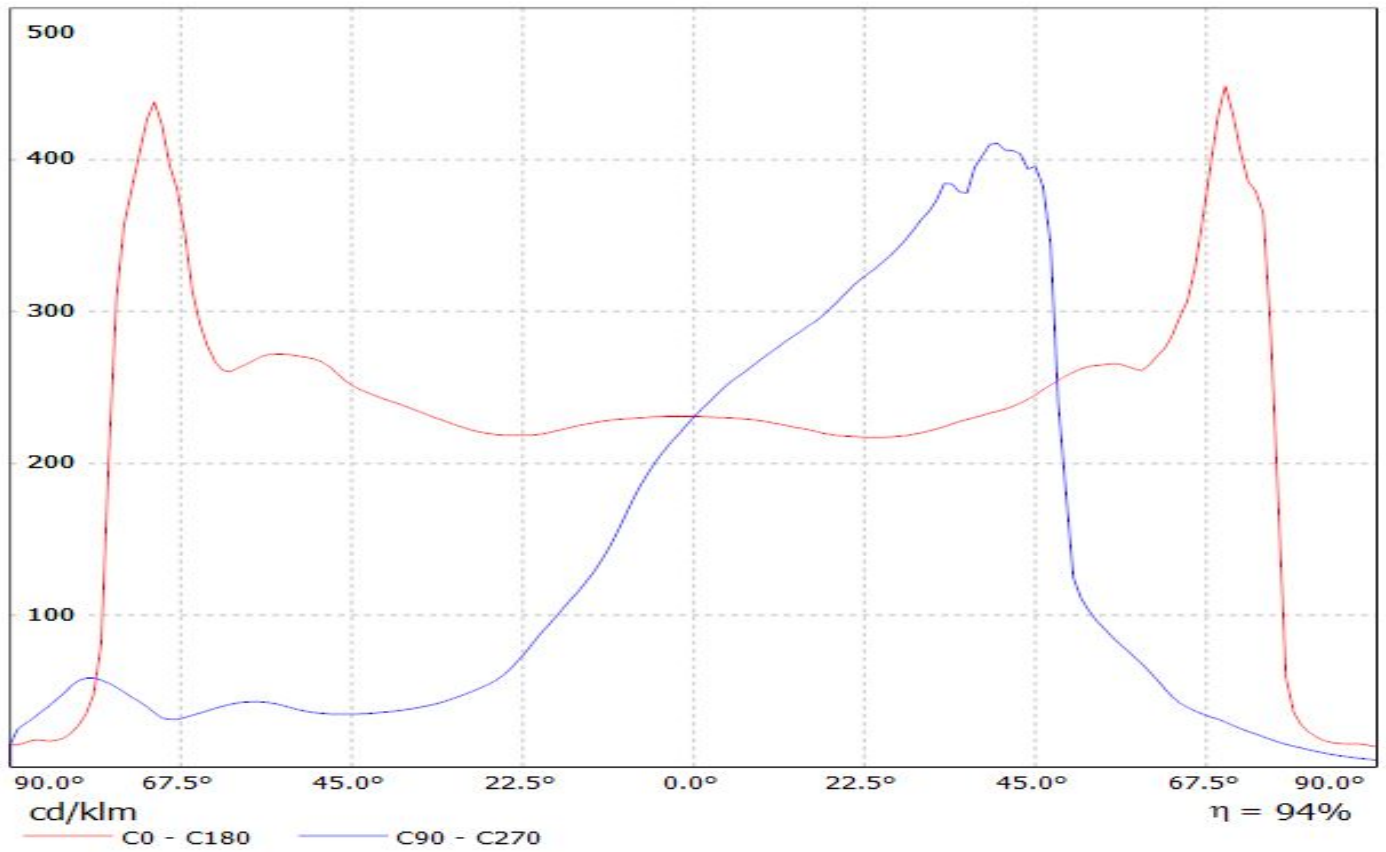

Luminaire: LEDiL Oy C13299_STRADA-2x2-ME_(Luxeon_T)
Lamps: 1 x Luxeon T (LXH8-FW30-3) 303lm@250mA P=2.80138W I=0.2499A

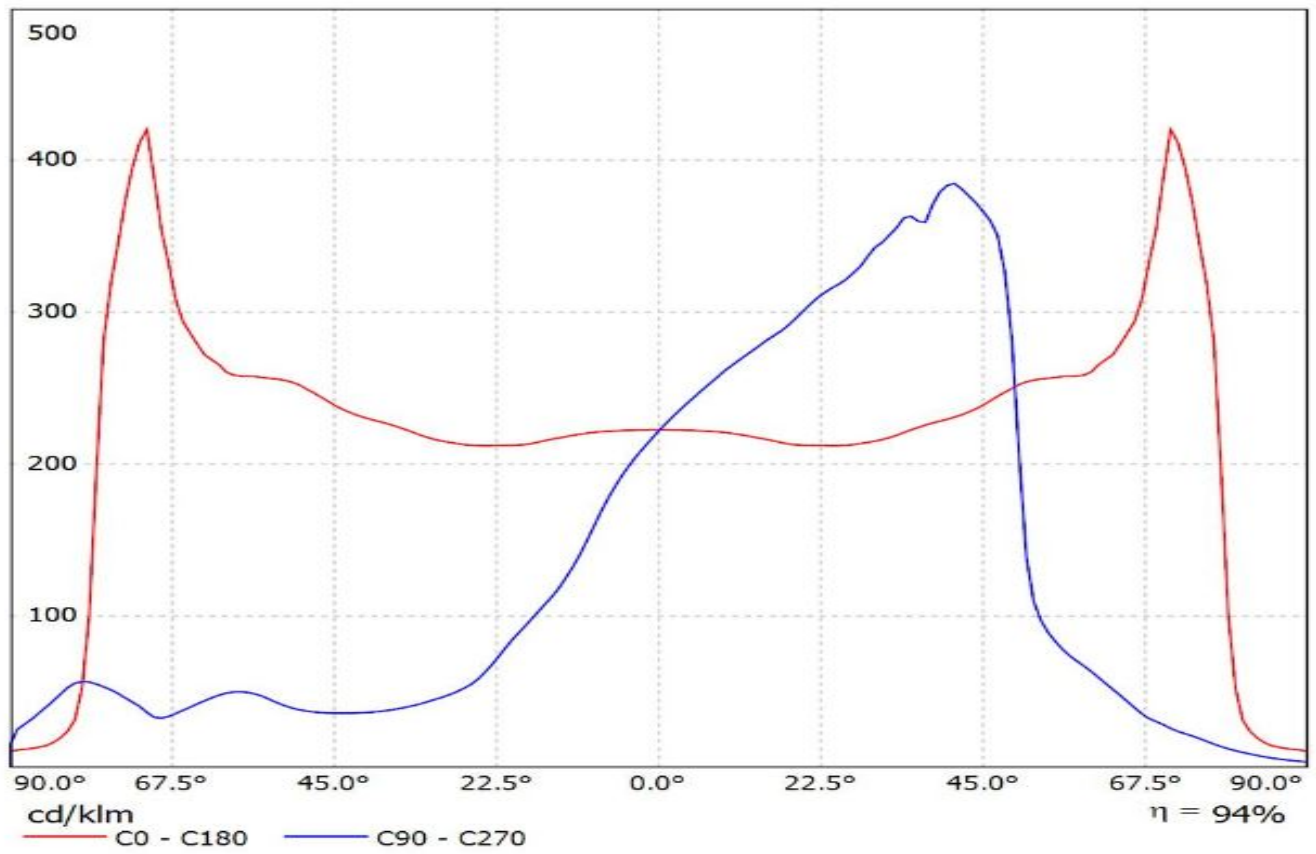

Luminaire: LEDiL Oy C13299_STRADA-2x2-ME_(Luxeon_Z_ES) Eff. 94%
Lamps: 1 x Luxeon_Z_ES_2x2_(LXZ2-3090)_210.126lm@250mA_P=2.81862W_I=249.9mA

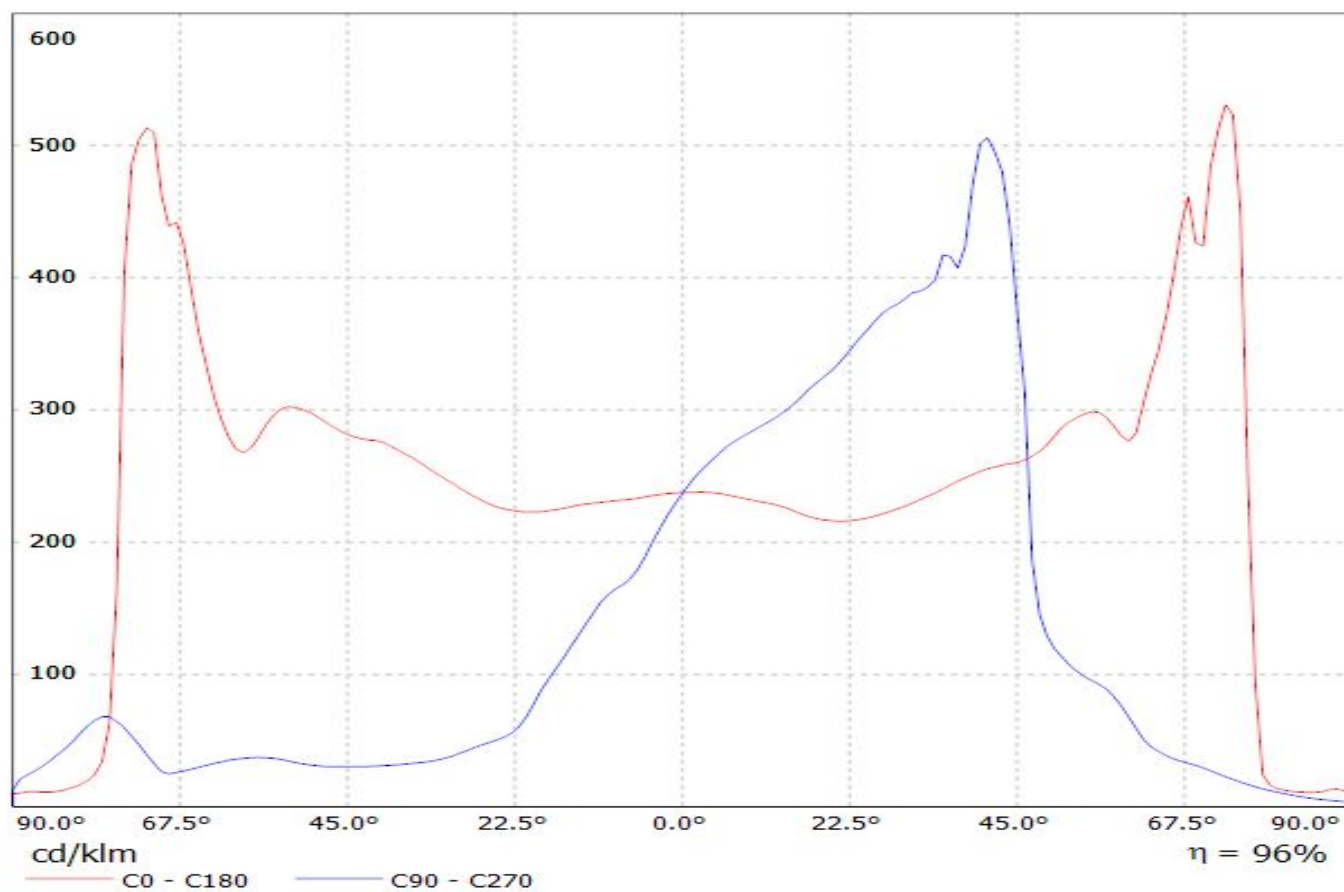

Luminaire: LEDiL Oy C13299_STRADA-2X2-ME_(LUXEON_Q)
Lamps: 1 x LUXEON_Q_2x2_(LHQ-3080)_298.615lm@250mA_P=2.86995W_I=249.8mA

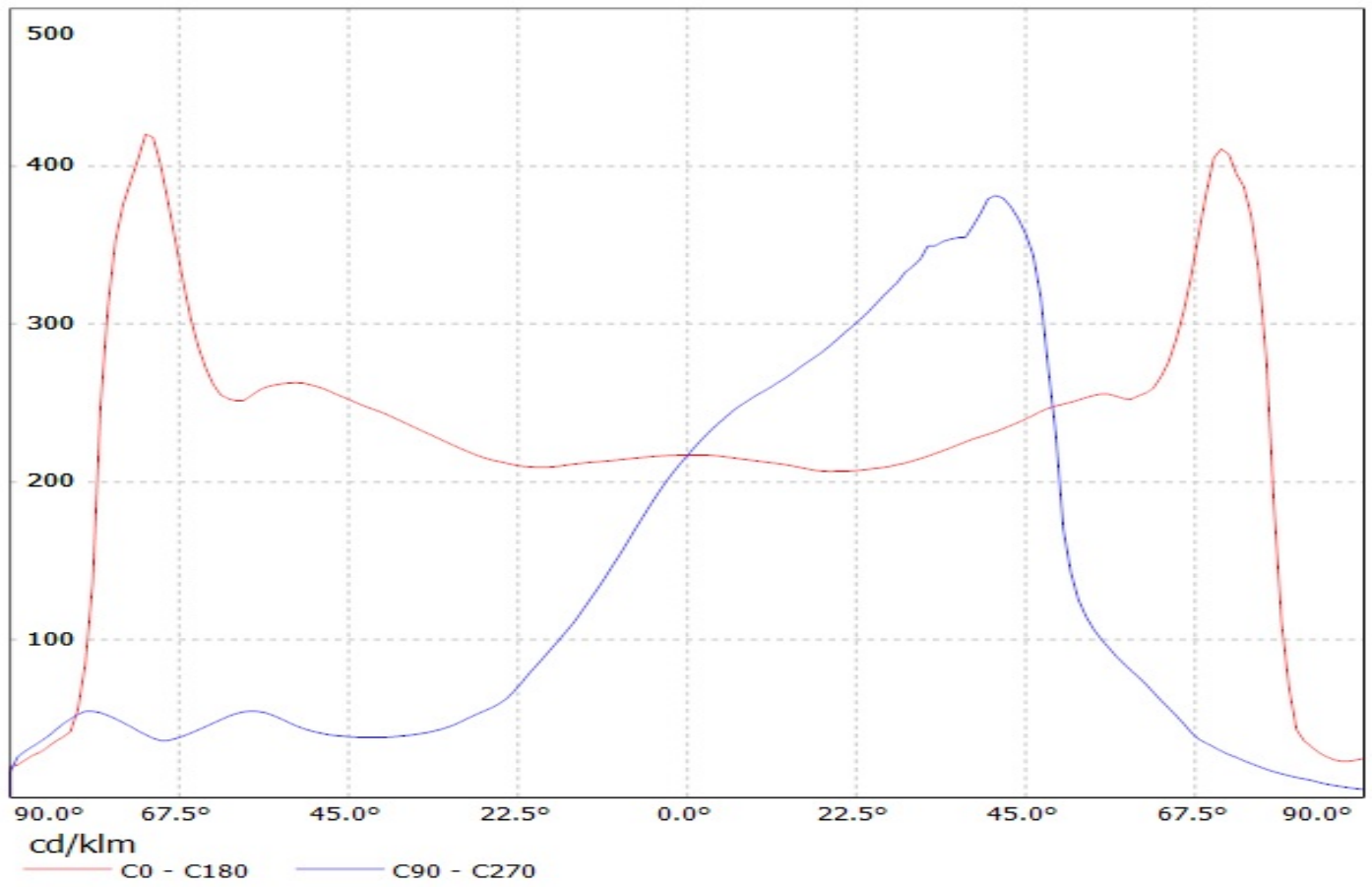

Luminaire: LEDiL Oy C13299_STRADA-2X2-ME_(LUXEON_MZ) Eff.94.0%
Lamps: 1 x LUXEON_MZ_2x2_(LMZ7-QW57)_419.8lm@250mA_P=2.71916W_CCT=5700K_I=249.9mA

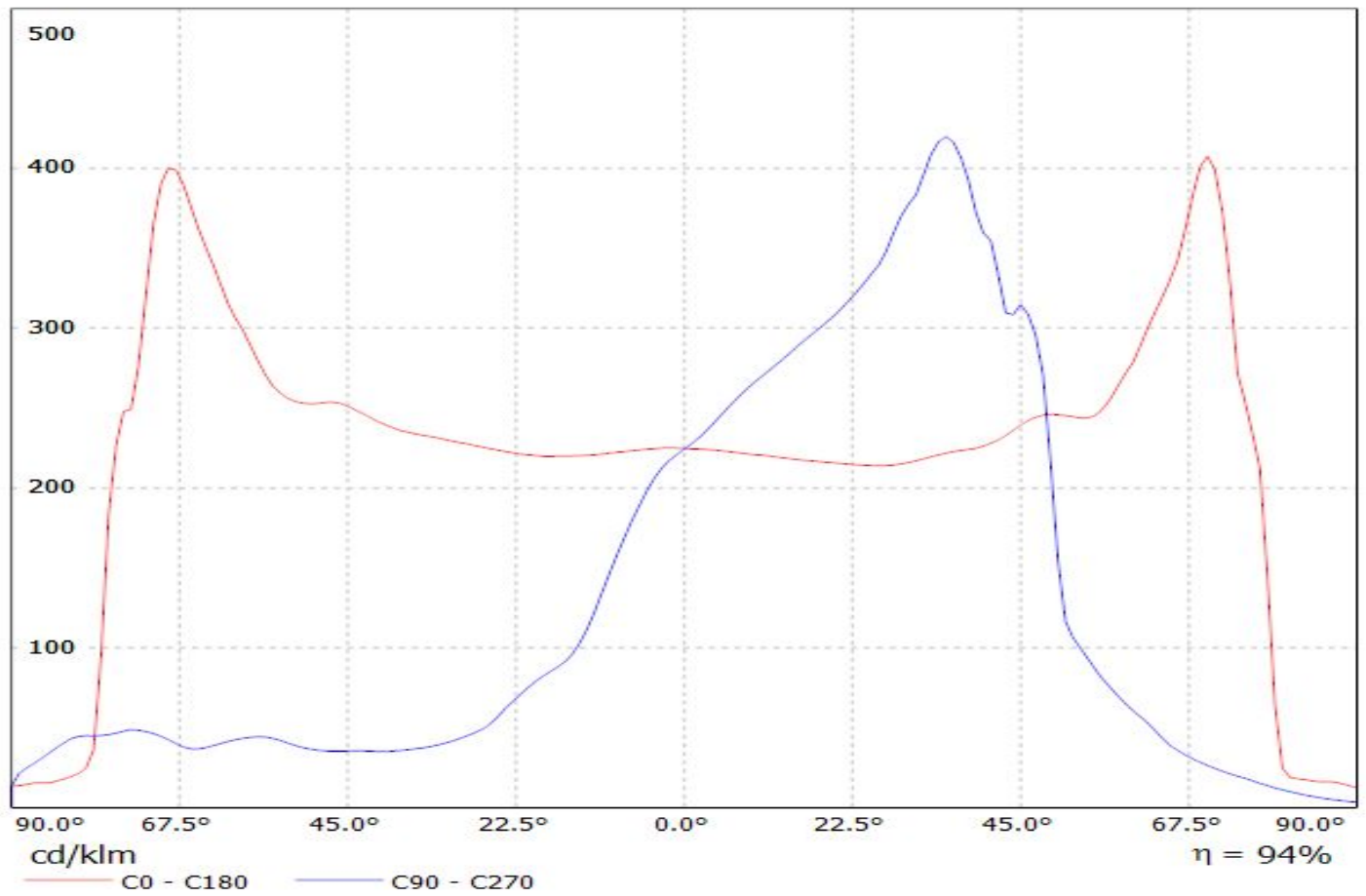

Luminaire: Ledil C13299_STRADA-2X2-ME_(Luxeon_TX)
Lamps: 1 x Luxeon_TX_2x2_(L1T2-3585)_331.643lm@250mA_P=3W_I=0.25A

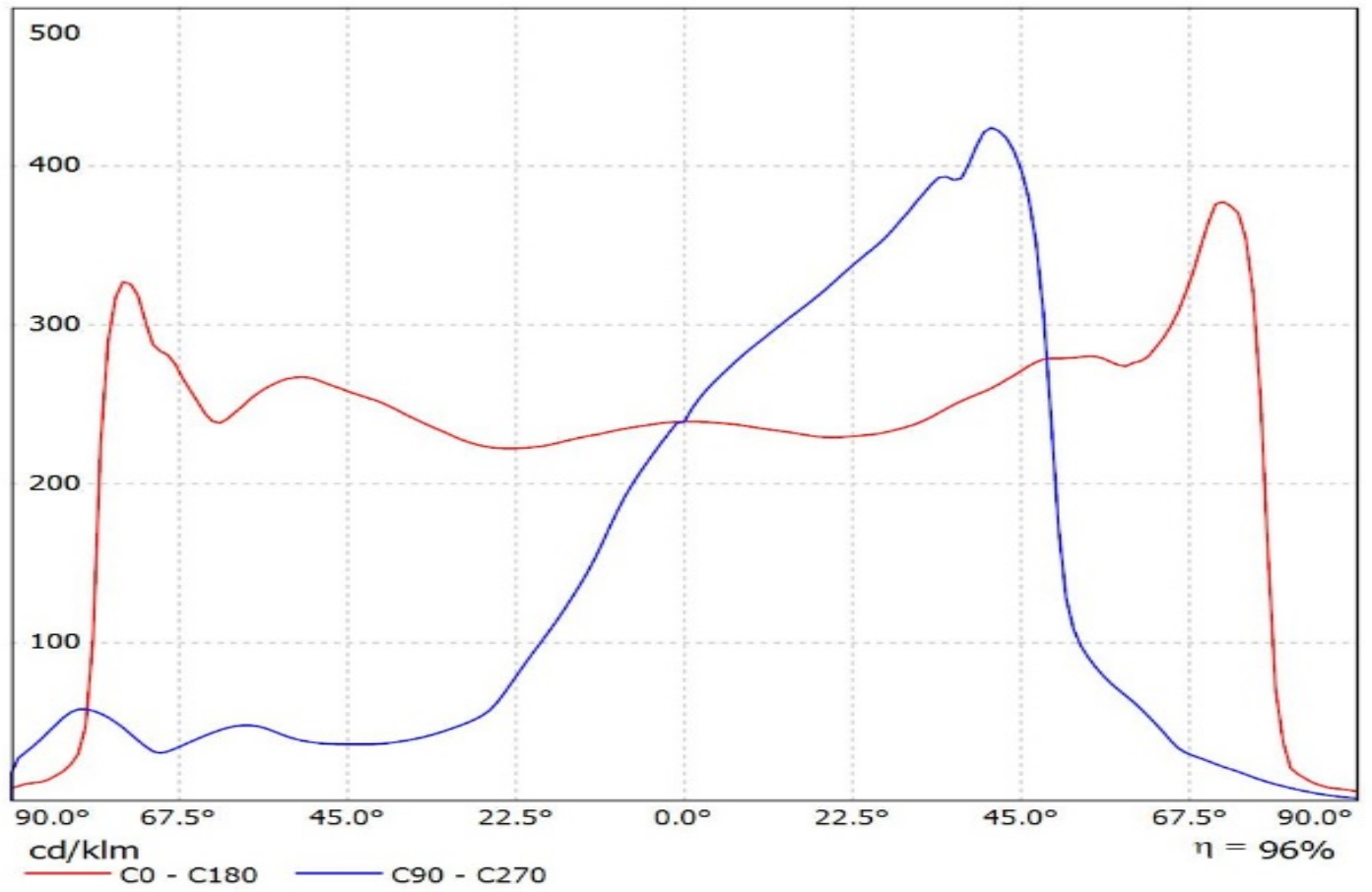

Luminaire: LEDiL Oy C13299_STRADA-2X2-ME_(Luxeon_5050)

Lamps: 1 x Luxeon_5050_2x2_1270.76lm@80mA_CCT=5700K_P=7.35815W_I=0.080A_70CRI

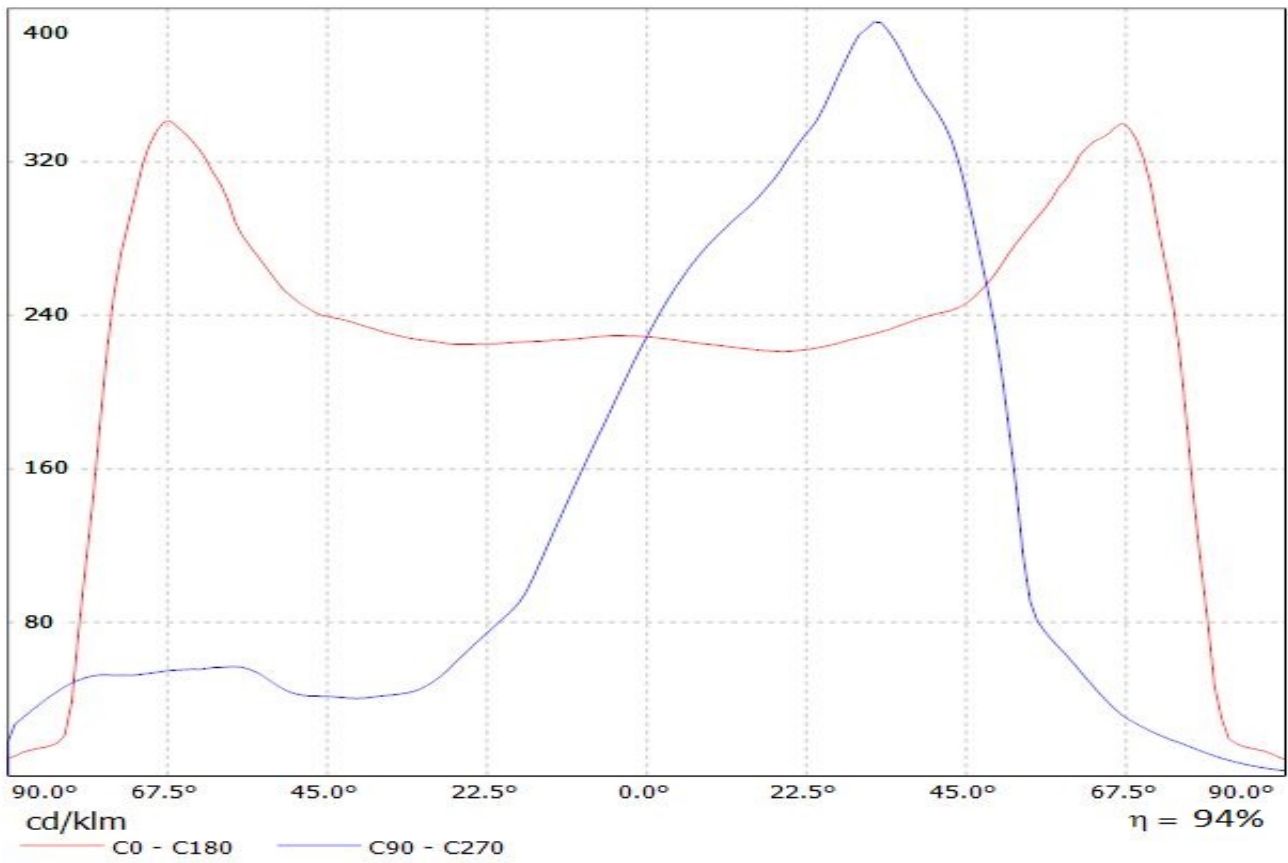

LEDiL Oy C13299_STRADA-2X2-ME_(N383) Eff.94.0% / LDC (Linear)

Luminaire: LEDiL Oy C13299_STRADA-2X2-ME_(N383) Eff.94.0%

Lamps: 1 x NICHIA_N383_2x2_(NS9W383T)_376.958lm@250mA_P=2.88194W_I=249.9mA

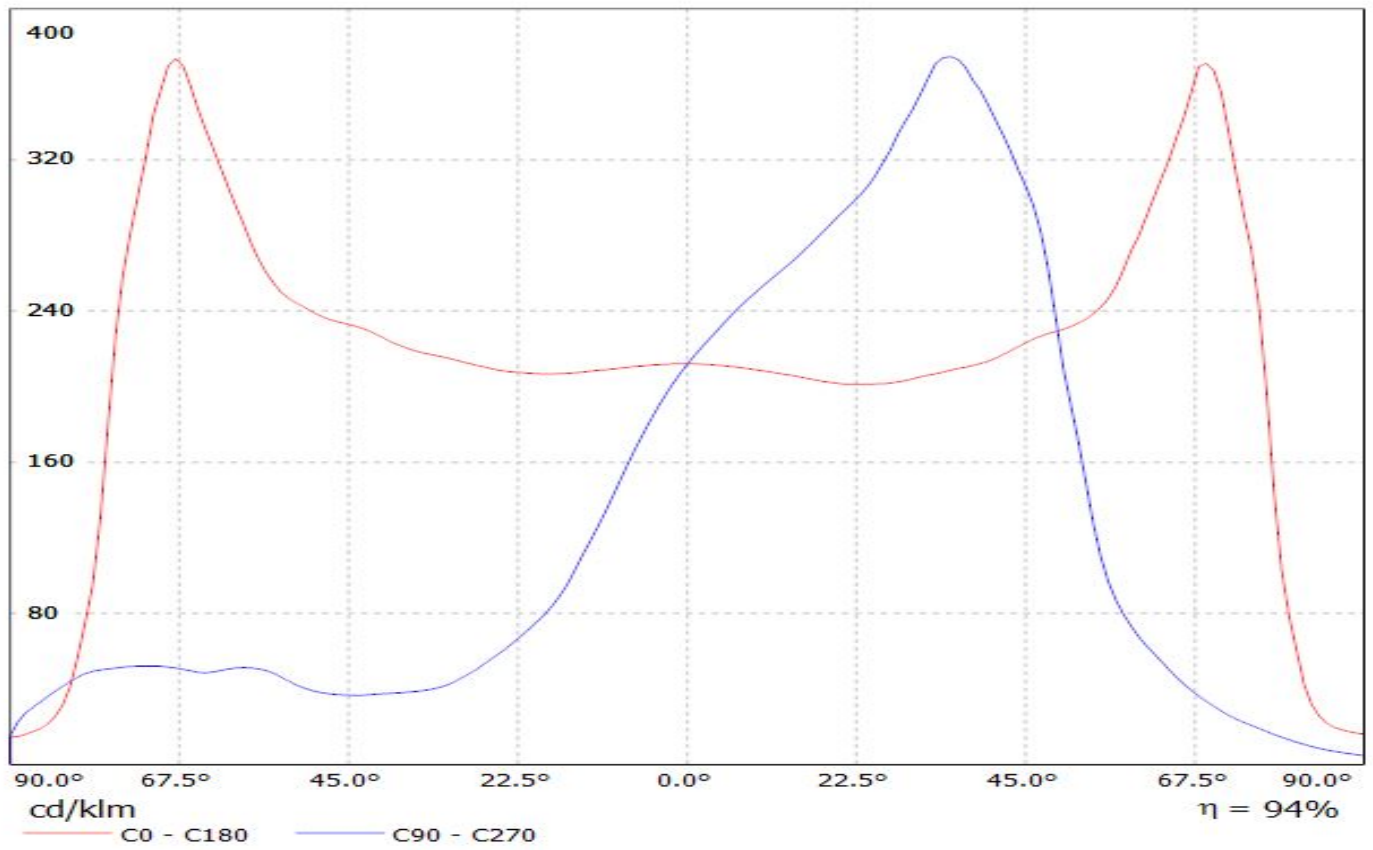

Luminaire: LEDiL Oy C13299_STRADA-2x2-ME_(NVSxx19B)

Lamps: 1 x Nichia_NVsxx19B_2x2_(NVSL219BE)_310.219lm@250mA_CCT=3071K_P=2.87735W_I=249.9mA

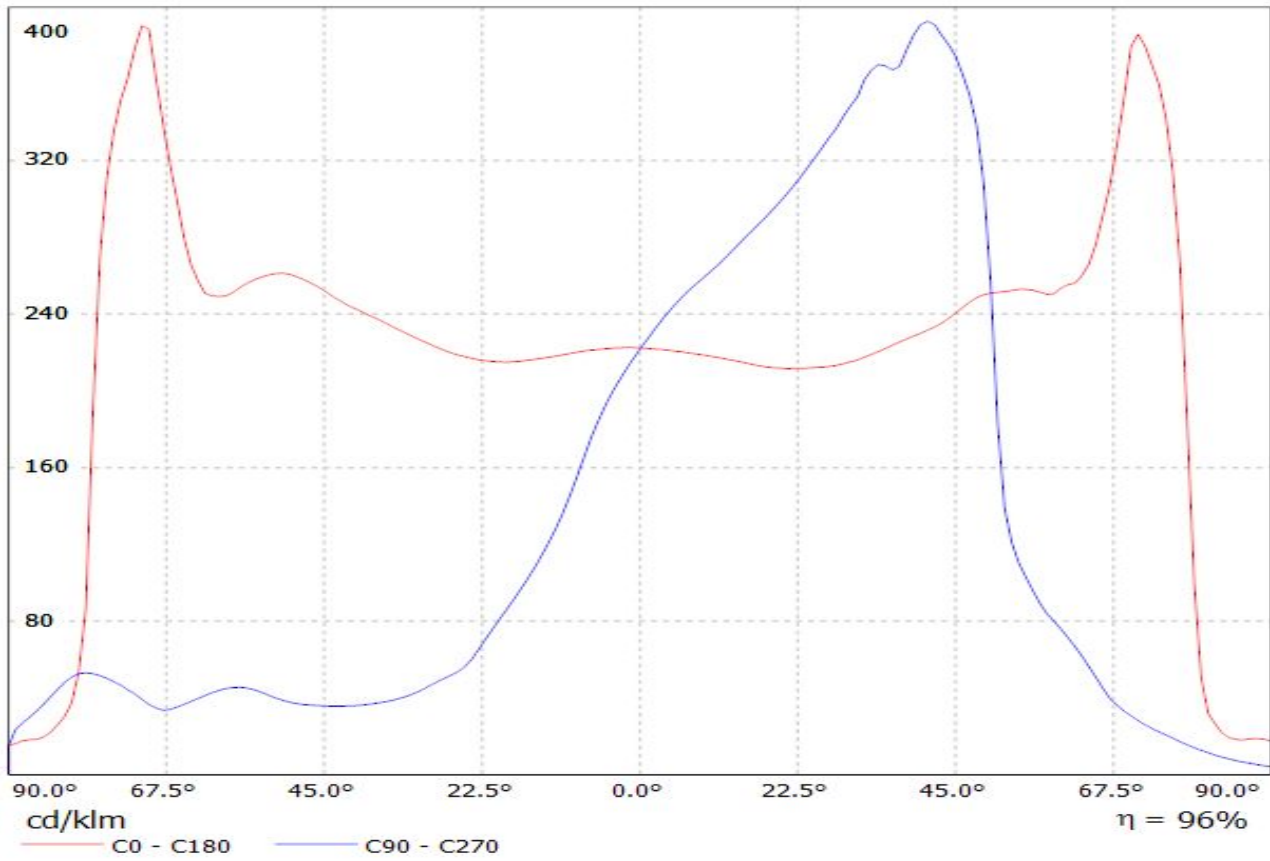

Luminaire: LEDiL Oy C13299_STRADA-2X2-ME_(NWSL229AE)
Lamps: 1 x Nichia_2X2_NWSL229AE_476.548lm@250mA_P=2.7515W_I=0.250A

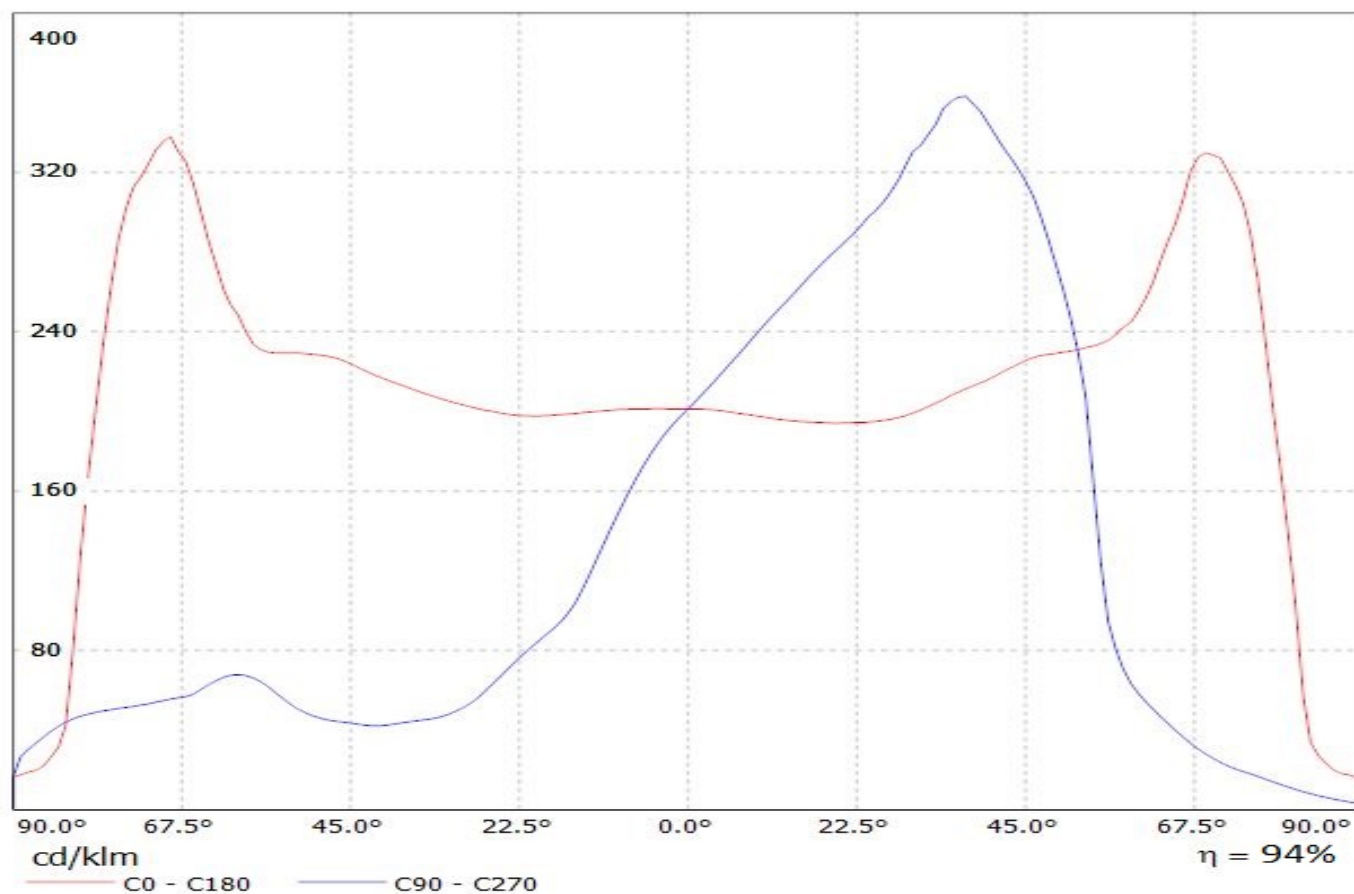

Luminaire: Ledil C13299_STRADA-2X2-ME_(NVSW319AE)
Lamps: 1 x Nichia_NVSW319AE_(sm405D440f2L2R70)

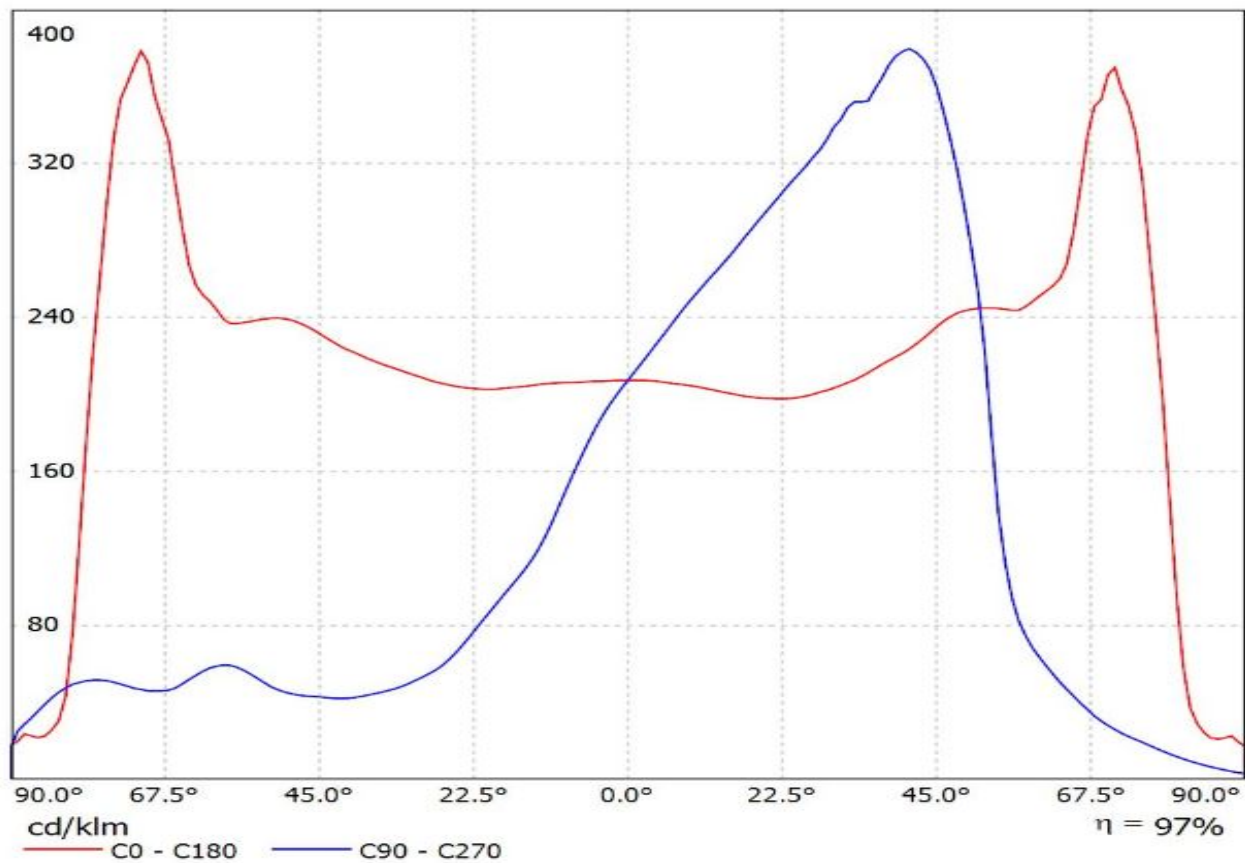

LEDiL Oy C13299_STRADA-2X2-ME_(SQ-PC) Eff.94.0% / LDC (Linear)

Luminaire: LEDiL Oy C13299_STRADA-2X2-ME_(SQ-PC) Eff.94.0%
Lamps: 1 x SQ-PC_2x2_(LCW-CQAR.PC-MSMU-5H71-1)_400.75lm@250mA_CCT=?
K_P=2.96681W_J=249.9mA

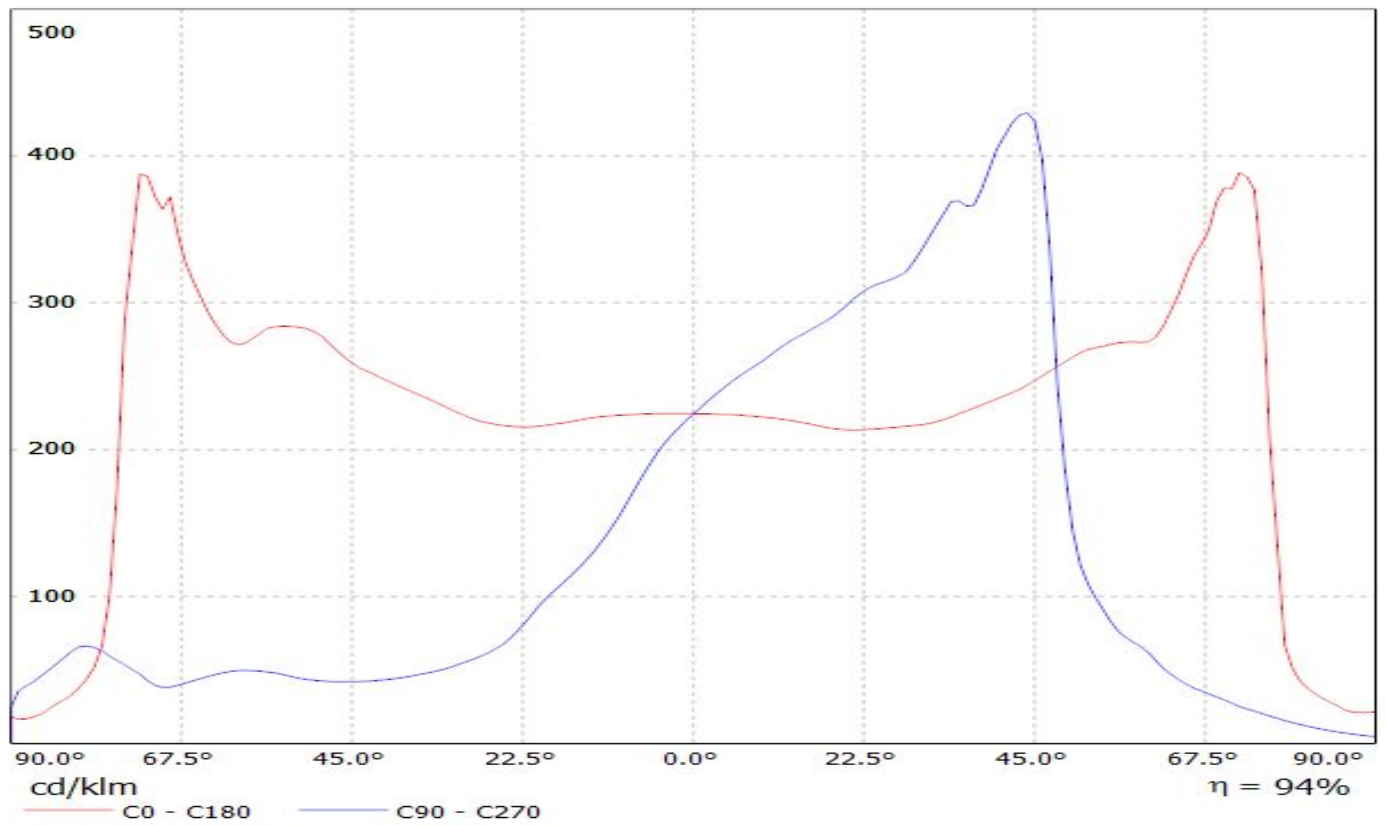

Luminaire: LEDiL Oy C13299_STRADA-2X2-ME_(Square_Gen3)

Lamps: 1 x Osram_Square_Gen3_GW_CSSRM2.PM_451.664lm@250mA_P=2.787_I=250mA

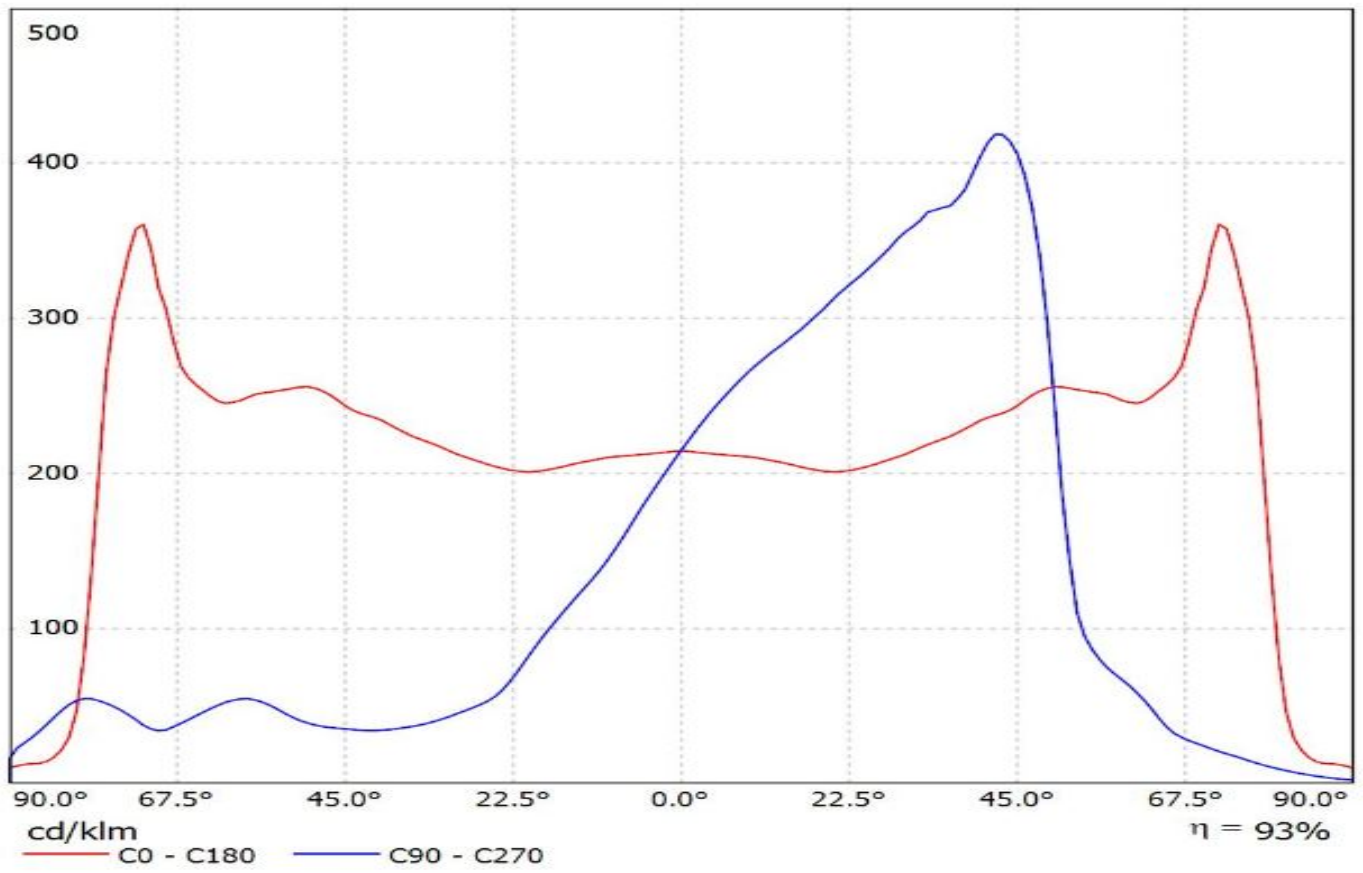

Luminaire: Ledil Oy C13299_STRADA-2X2-ME_(Duris_P8)_SIMULATED
Lamps: 1 x Osram Duris P8

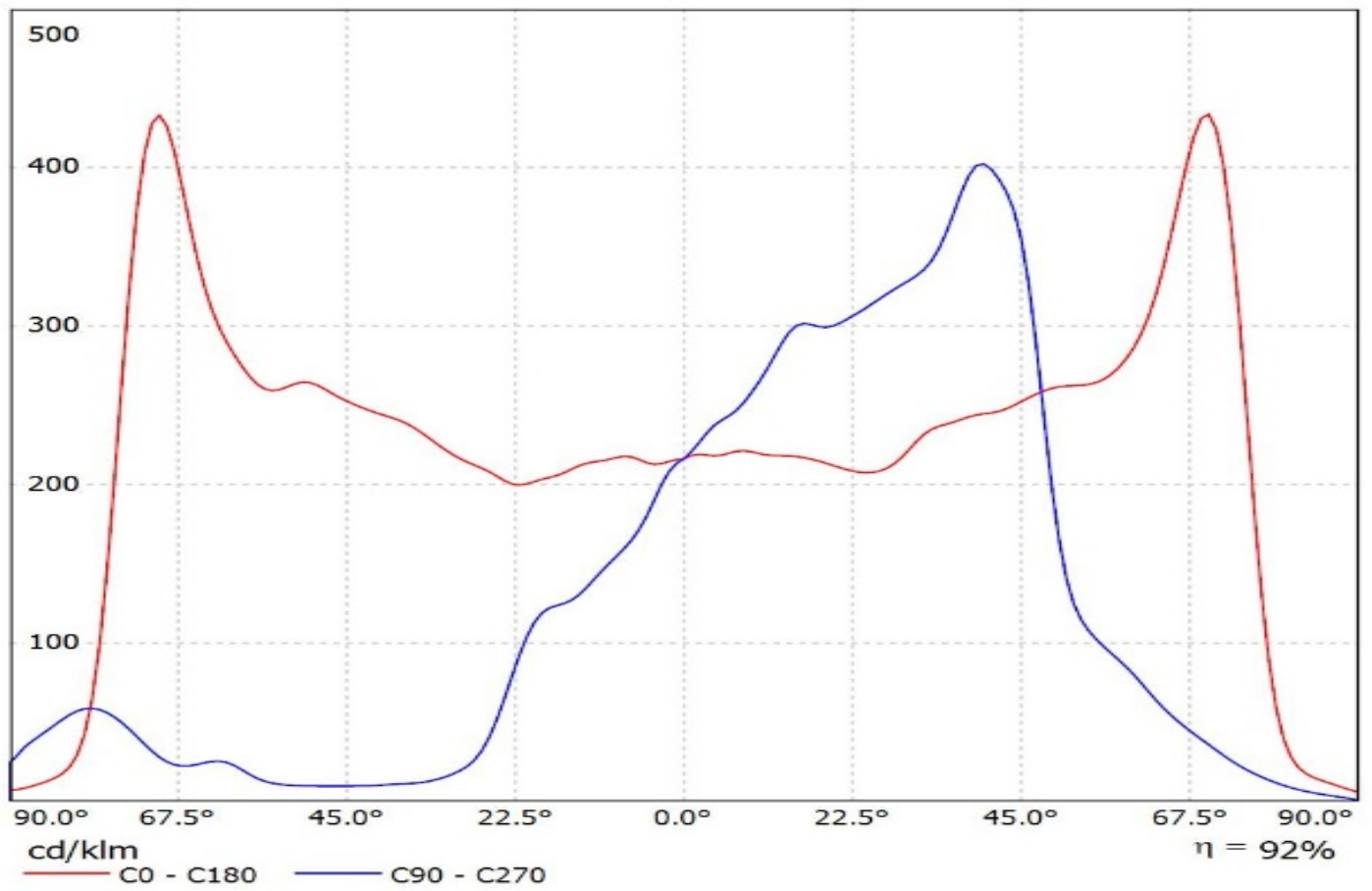

Luminaire: LEDiL Oy C13299_STRADA-2X2-ME_(Fortimo_F-Flex_2x8_740DAG3)

Lamps: 1 x Philips_Fortimo_F-Flex_2x8_740DAG3_1786.86lm@250mA_P=11.6092W_I=0.2498A

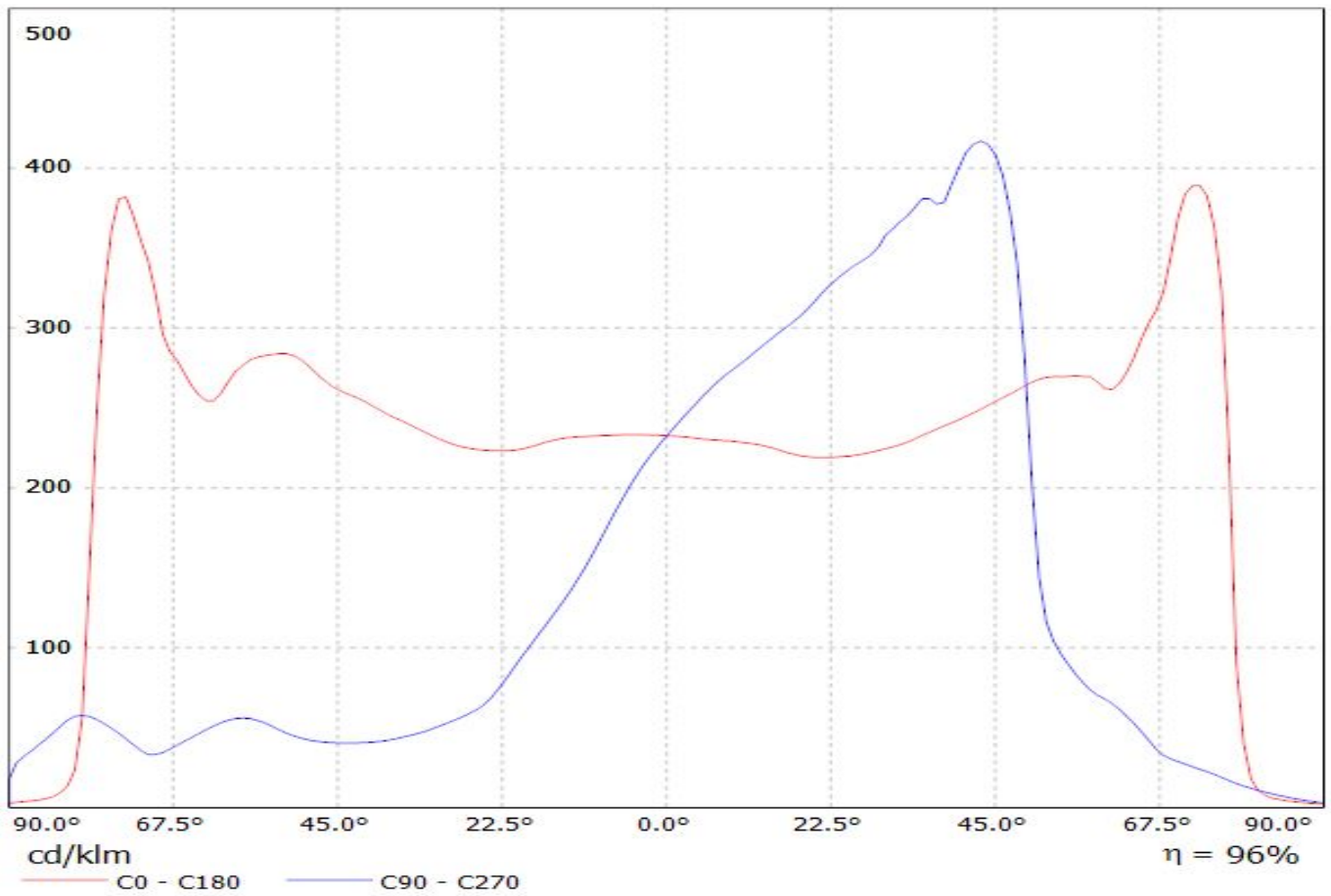

Luminaire: LEDiL Oy C13299_STRADA-2X2-ME_(LH351B)

Lamps: 1 x SAMSUNG_LH351B_2x2_442.45lm@250mA_P=2.84311W_I=249.9mA

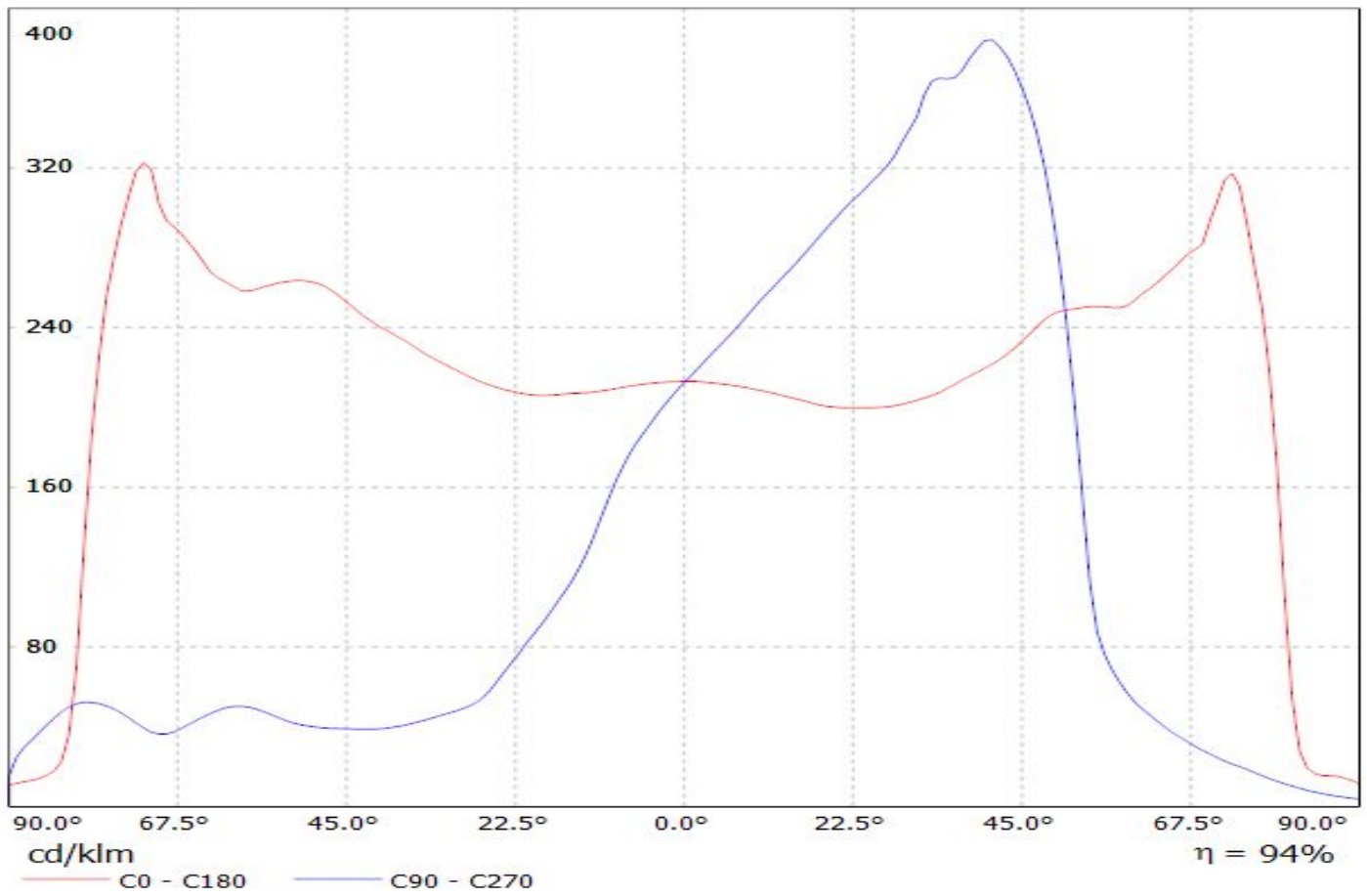

Luminaire: LEDiL Oy C13299_STRADA-2X2-ME_(LH351D)

Lamps: 1 x Samsung_LH351D_524.264lm@250mA_P=2.7523W_I=0.250A

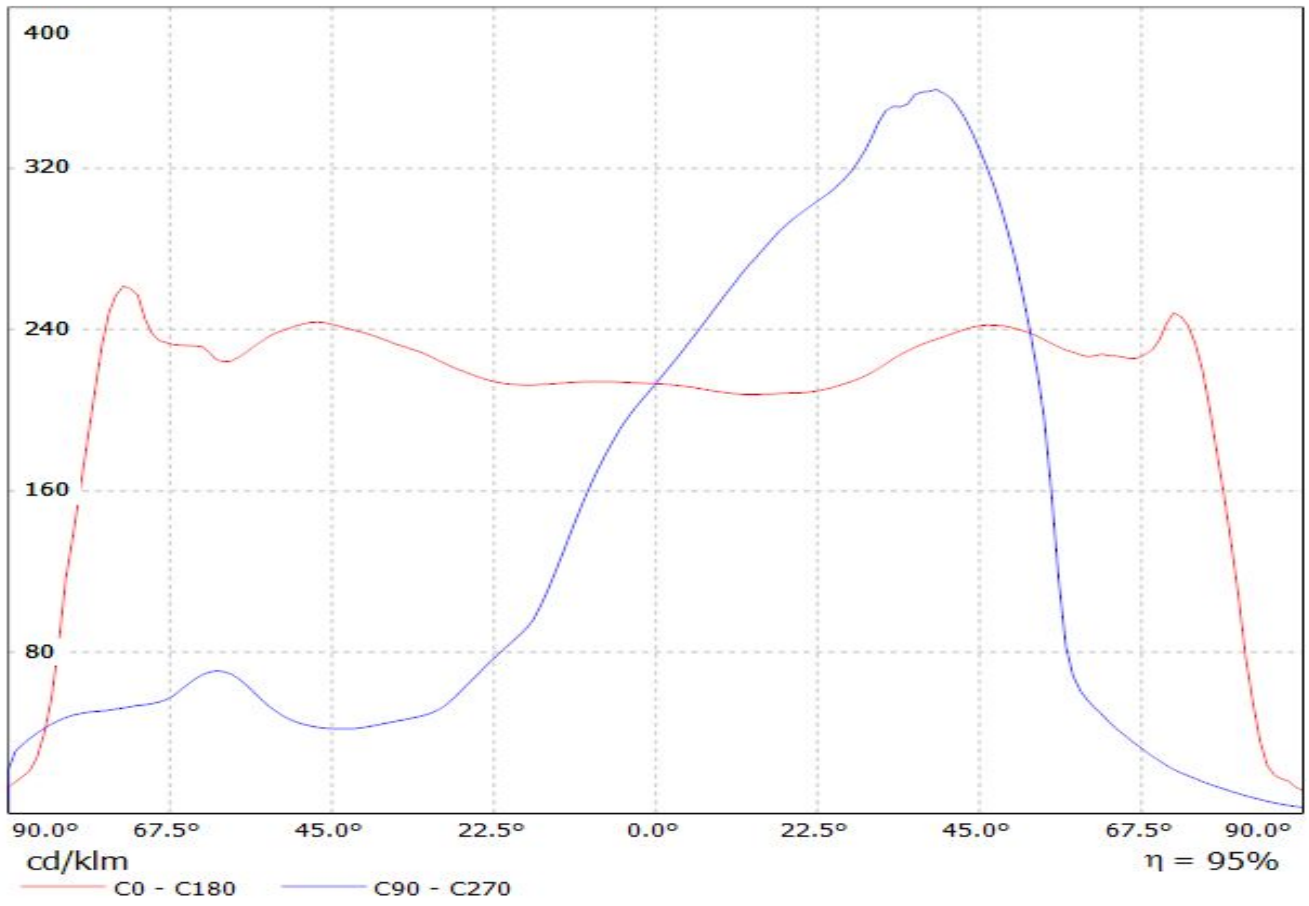

Luminaire: Ledil C13299_STRADA-2X2-ME_(LH351C)
Lamps: 1 x Samsung_LH351C_518.223lm@250mA_P=2.85225W_I=0.25A

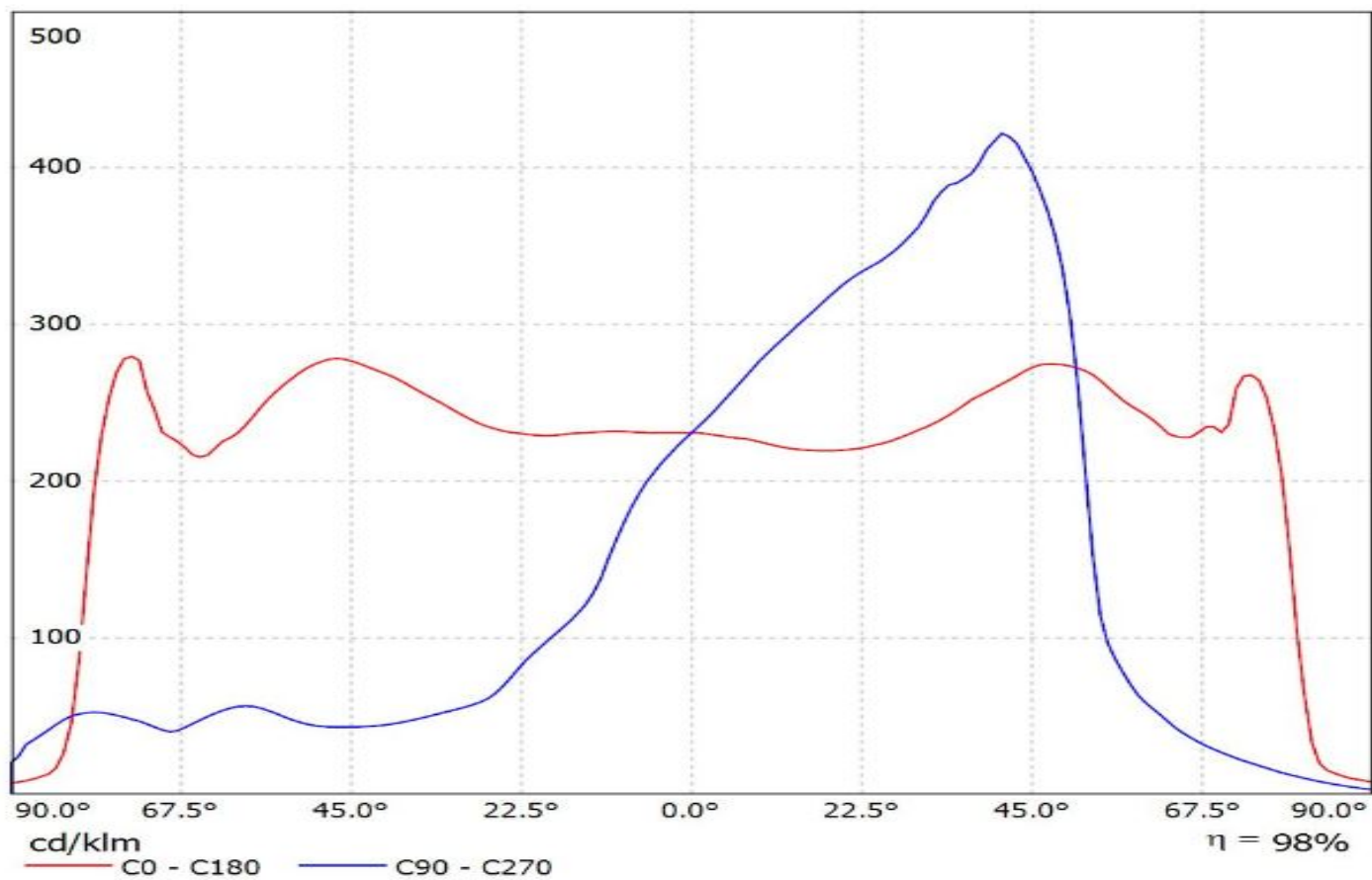

Luminaire: Ledil C13299_STRADA-2X2-ME_(LH508A)

Lamps: 1 x Samsung_LH508A_2x2_2060.04lm@160mA_CCT=5000K_CRI=80_P=15.5405W_I=0.16A

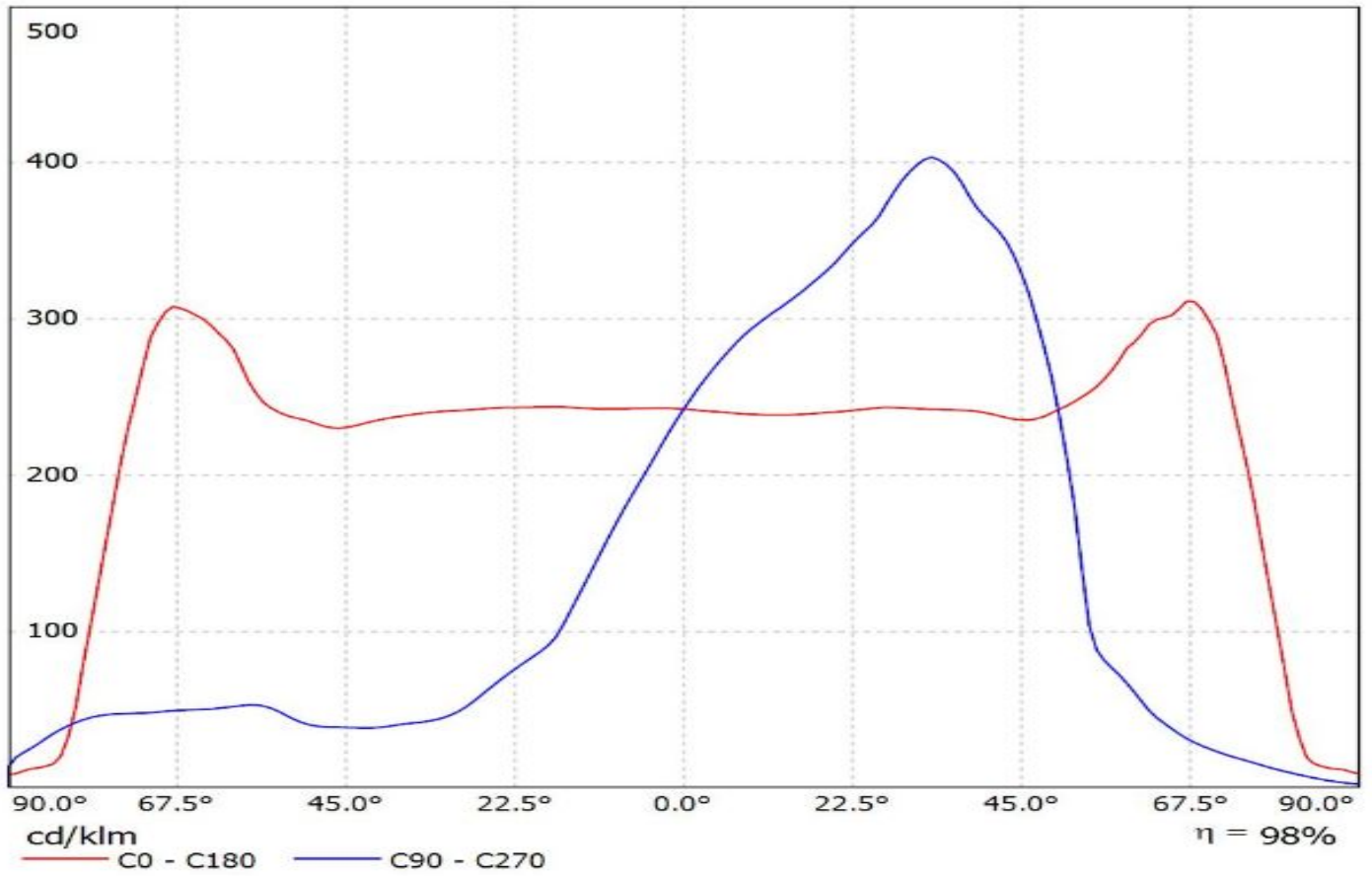

LEDiL Oy C13299_STRADA-2X2-ME_(Z5P) Eff.94.0% / LDC (Linear)

Luminaire: LEDiL Oy C13299_STRADA-2X2-ME_(Z5P) Eff.94.0%
Lamps: 1 x Seoul_Z5P_2x2_290.05lm@250mA_P=3.6208W_I=249.9mA

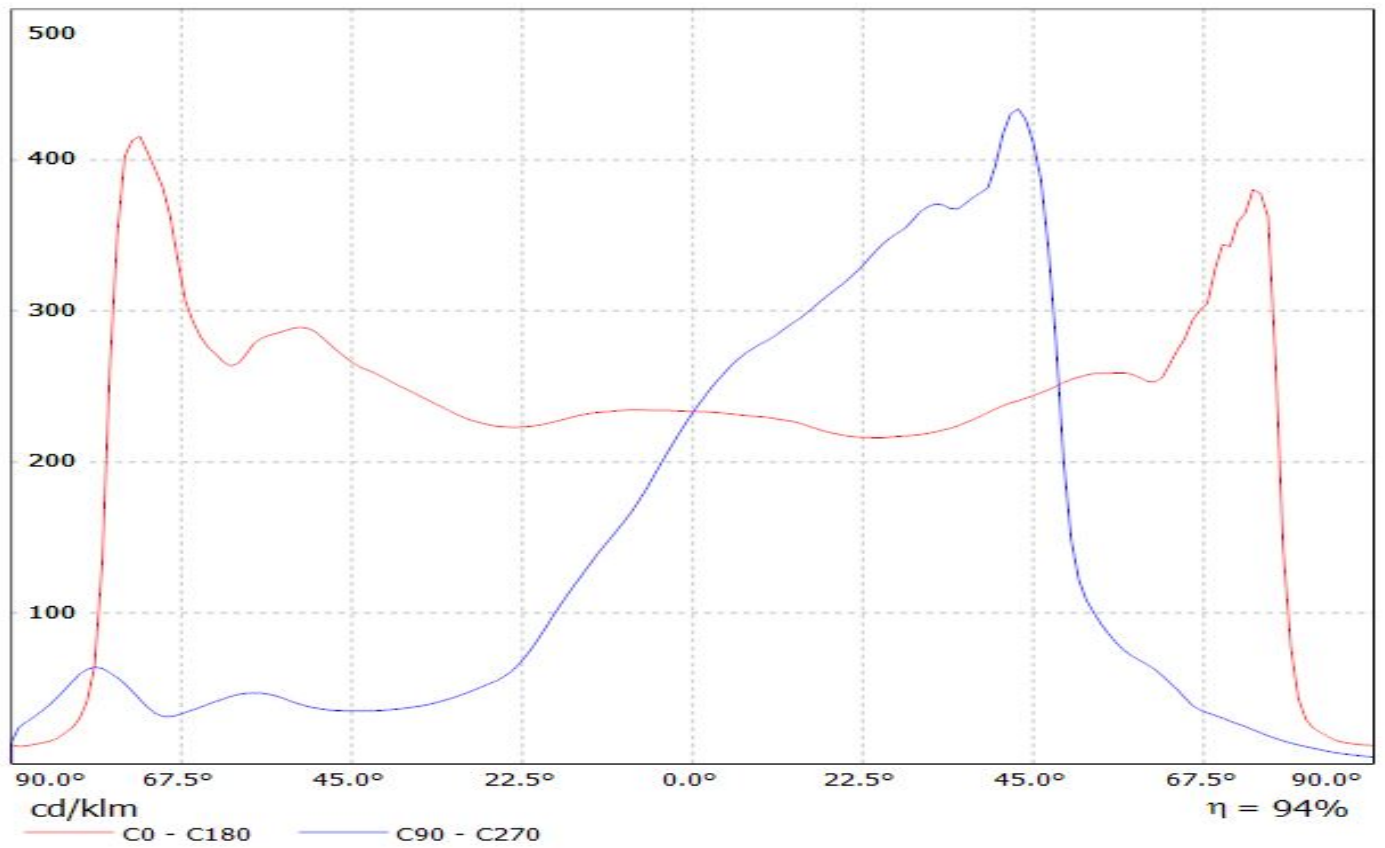

Luminaire: LEDiL Oy C13299_STRADA-2x2-ME_(MJT4040) Eff. 94%
Lamps: 1 x SEOUL ACHRICH MJT4040 (SAW09H0A) 255lm@40mA P=2.37W I=40mA

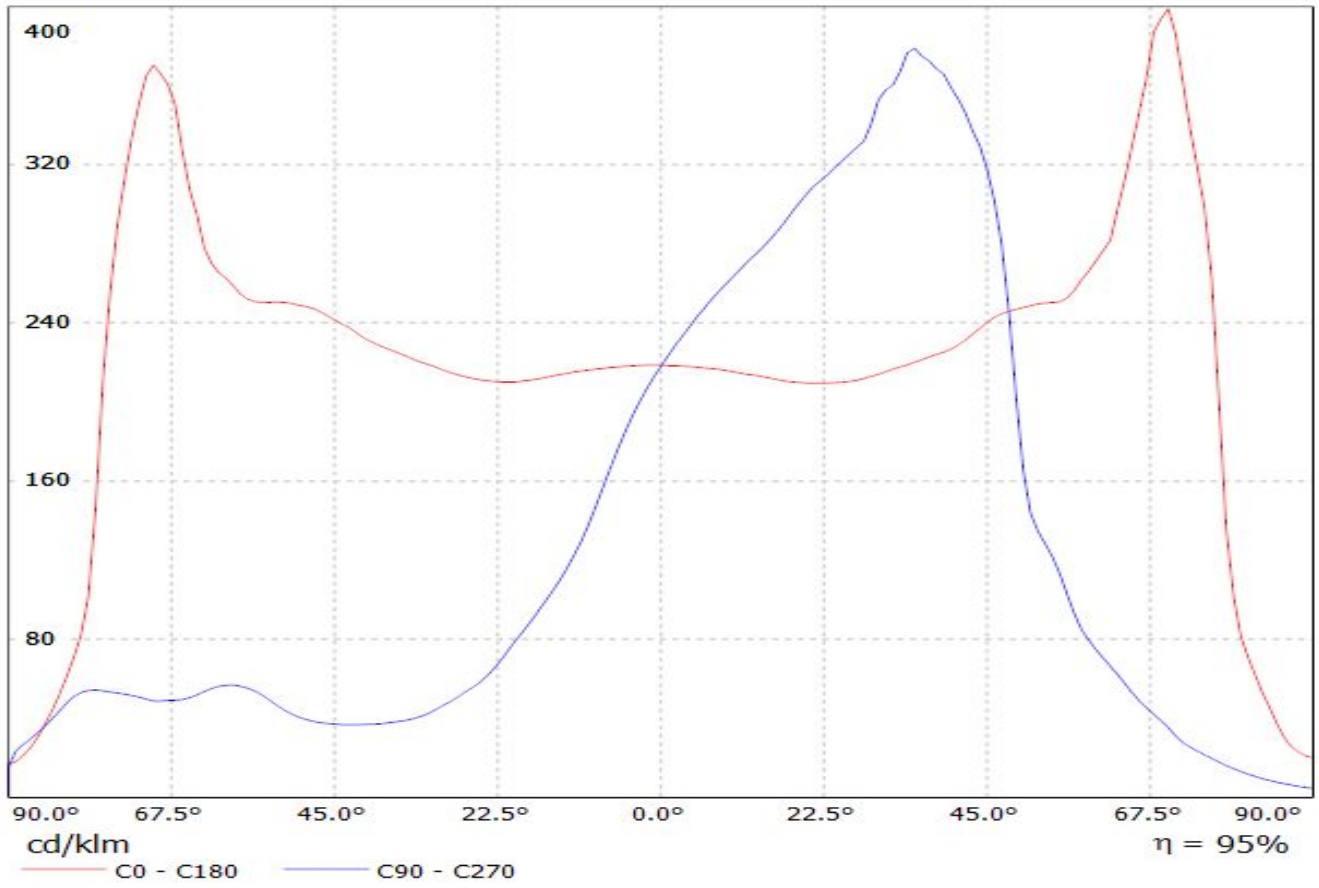

LEDiL Oy C13299_STRADA-2X2-ME_(Z5M) Eff.94.0% / LDC (Linear)

Luminaire: LEDiL Oy C13299_STRADA-2X2-ME_(Z5M) Eff.94.0%

Lamps: 1 x SEOUL_Z5M_(SZ5-M0-W0-00)_364.5lm@250mA_P=2.95788W_I=249.8mA

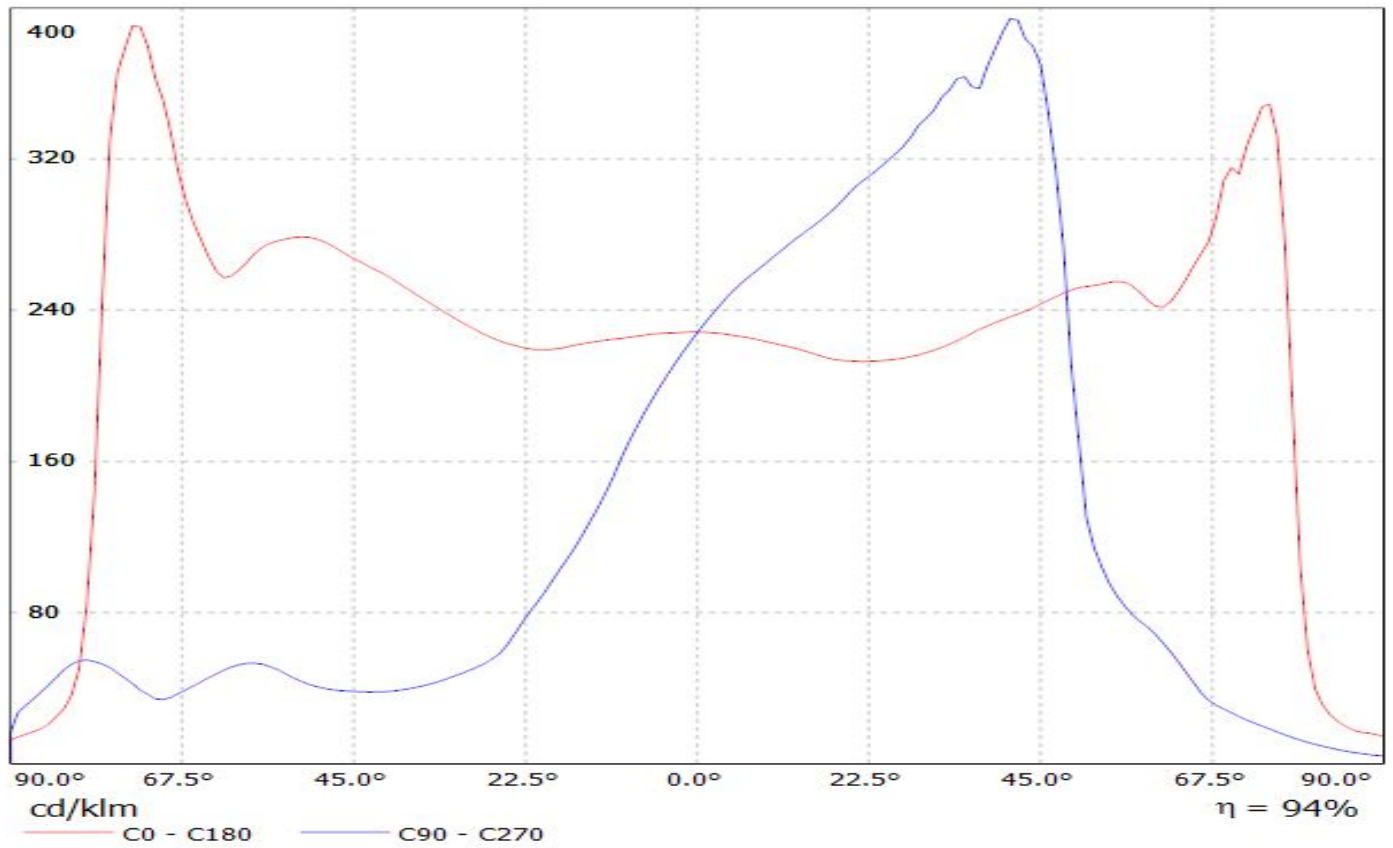

Luminaire: LEDil Oy C13299_STRADA-2X2-ME_(Z5M1) Efficiency=94%
Lamps: 1 x Seoul Z5M1 (SZ5-M1-WN-C8) 379lm @ 250mA CCT=4600K P=2.9W I=250mA

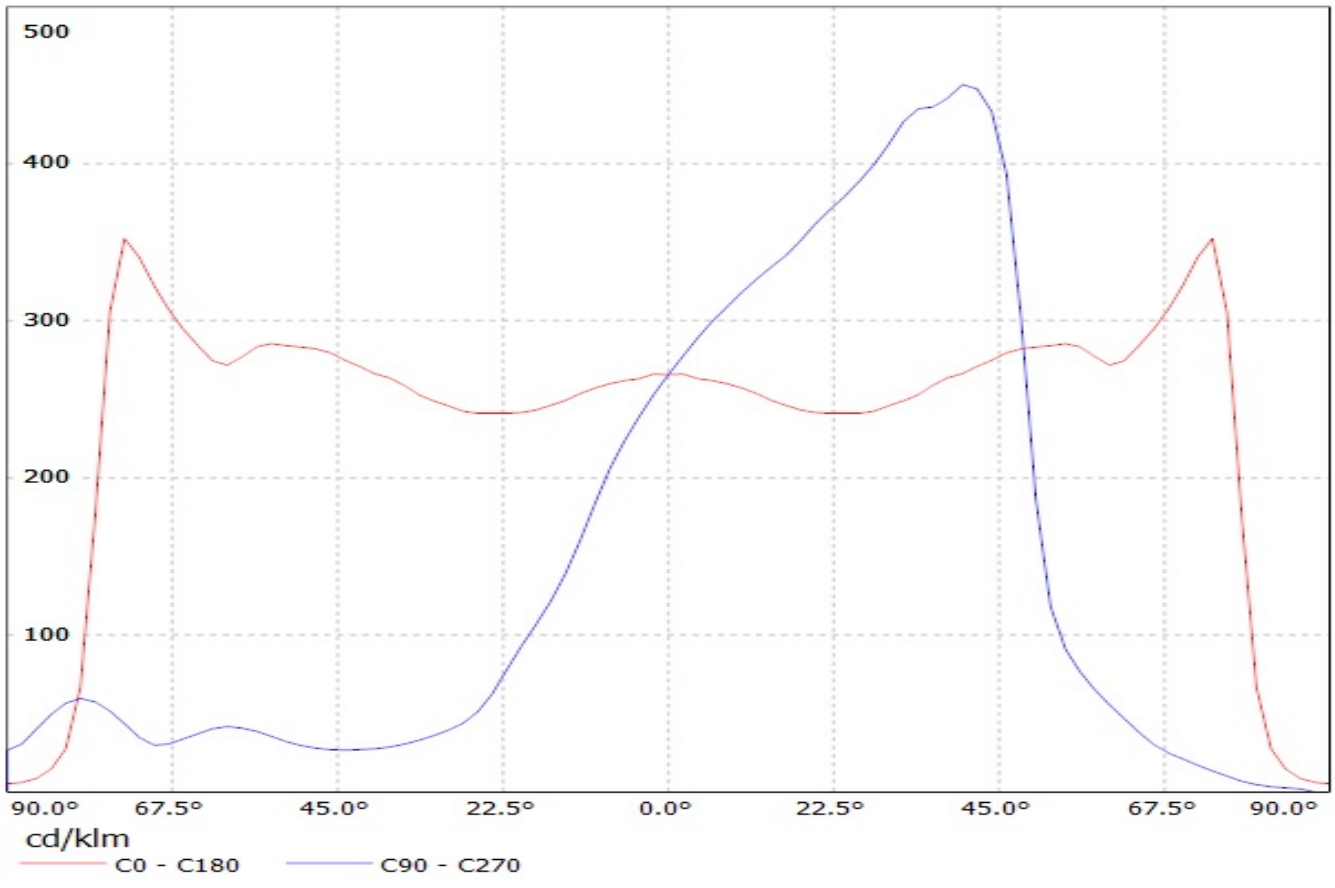

Luminaire: Ledil C13299_STRADA-2X2-ME_(Z8Y22plus)

Lamps: 1 x Seoul_Z8Y22plus_(W6E2G)_513.996lm@250mA_P=2.754W_I=0.250A

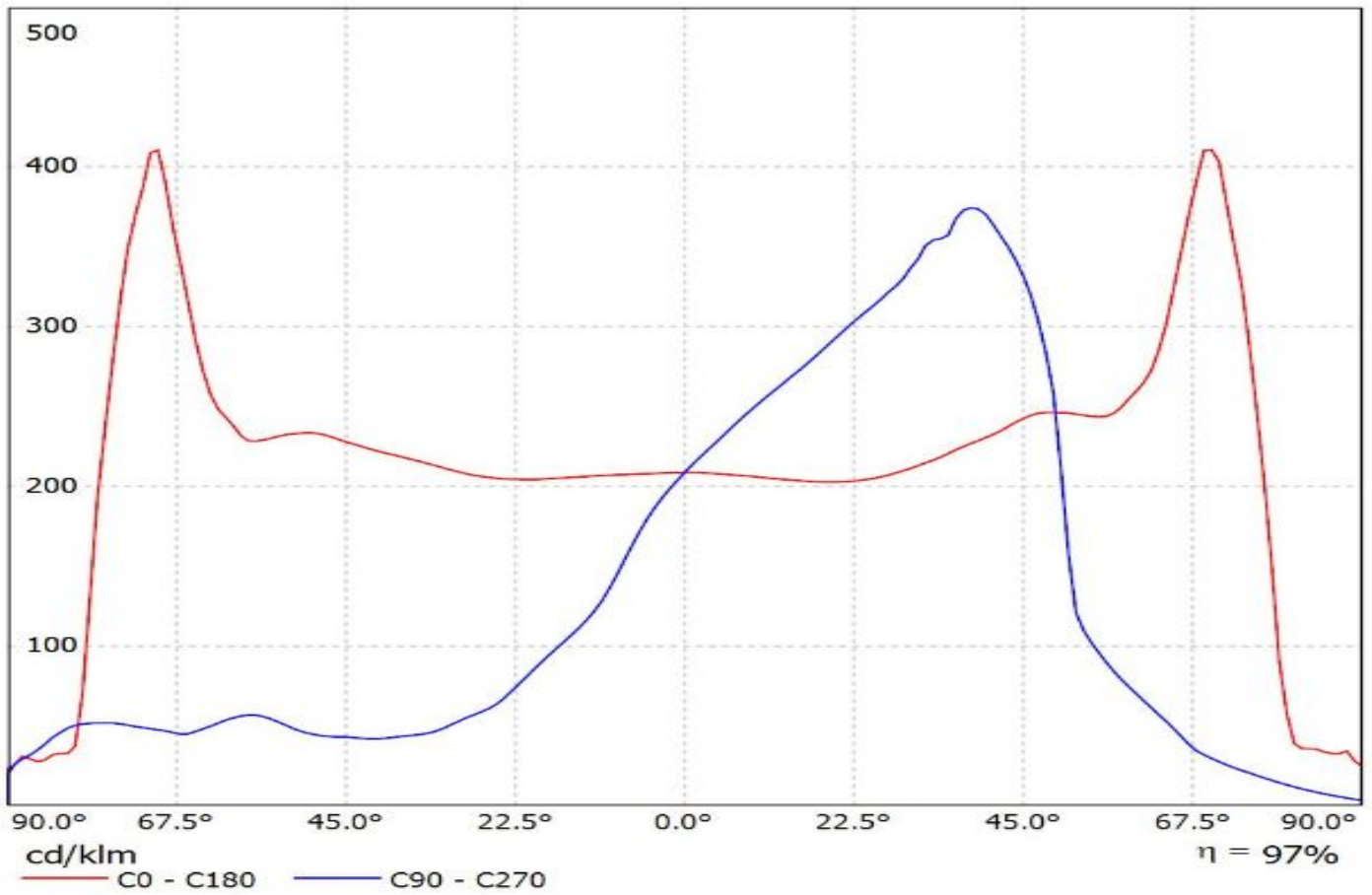

Ledil C13299_STRADA-2X2-ME_(TL1L3) / LDC (Linear)

Luminaire: Ledil C13299_STRADA-2X2-ME_(TL1L3)

Lamps: 1 x Toshiba_TL1L3_2x2_(TL1L3-NW1.L)_387.773lm@250mA_CCT=5000K_P=2.829W_I=0.25A

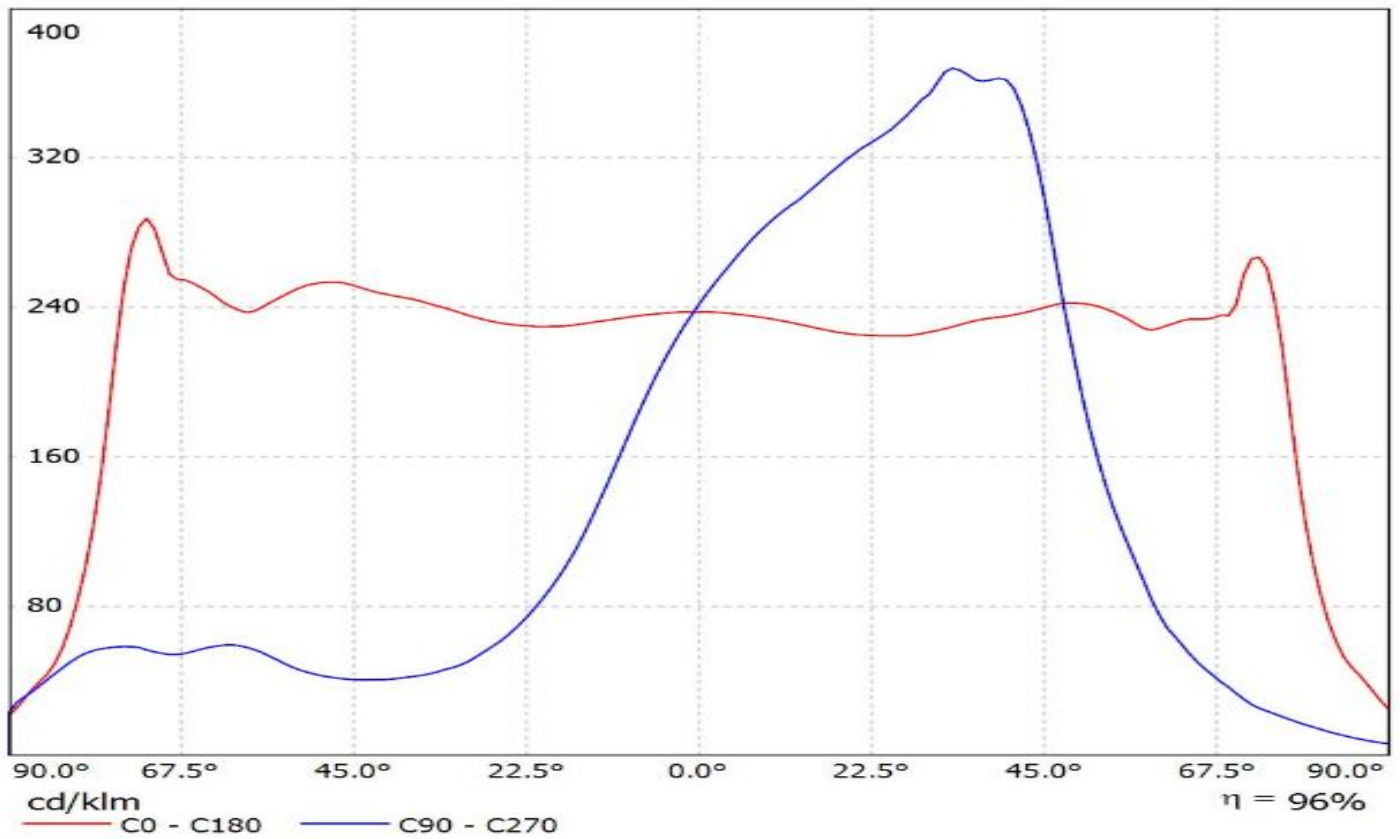

Ledil C13299_STRADA-2X2-ME_(TL1L4) / LDC (Linear)

Luminaire: Ledil C13299_STRADA-2X2-ME_(TL1L4)

Lamps: 1 x Toshiba_TL1L4_2x2_(TL1L4-DW0)_472.639lm@250mA_CCT=6500K_P=2.9W_I=0.25A

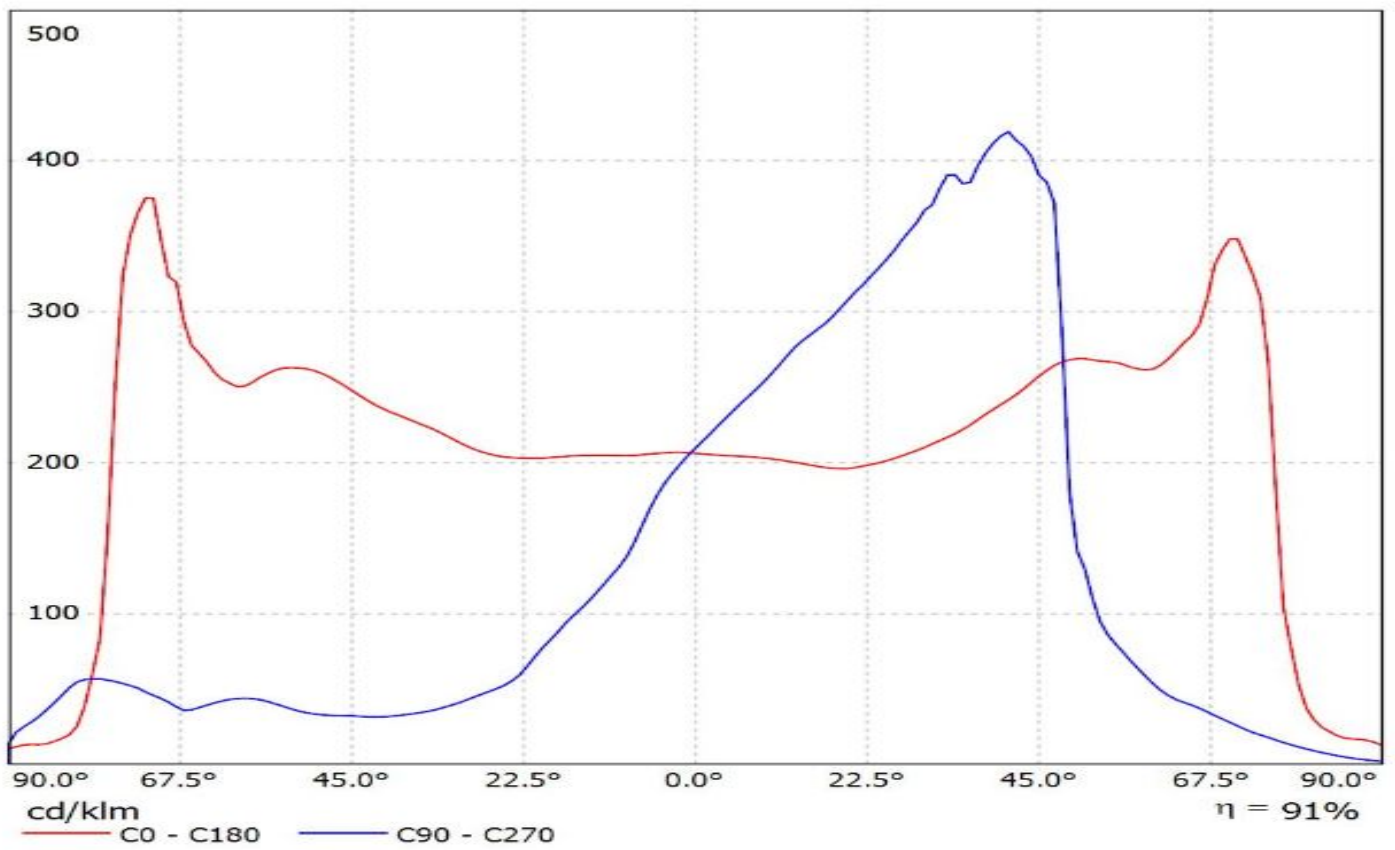

Luminaire: LEDiL Oy C13299_STRADA-2X2-ME_(Tridonic_Module_RLE_G1)
Lamps: 1 x Tridonic_Module_RLE_G1_4576.03lm@700mA_P=32.0681W_I=0.700A

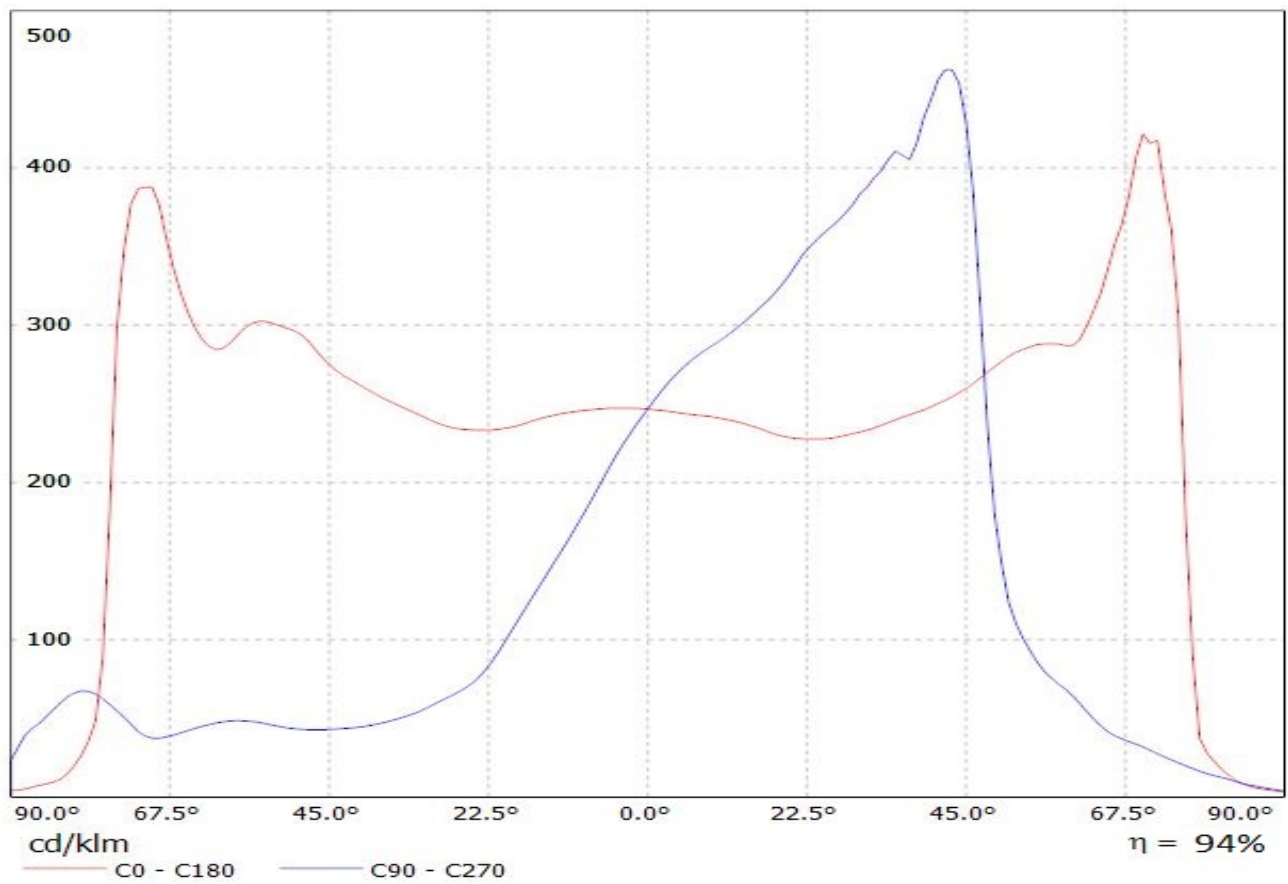

Luminaire: LEDiL Oy C13299_STRADA-2X2-ME_(Tridonic_Module_RLE_G1)
Lamps: 1 x Tridonic_Module_RLE_G1_4576.03lm@700mA_P=32.0681W_I=0.700A

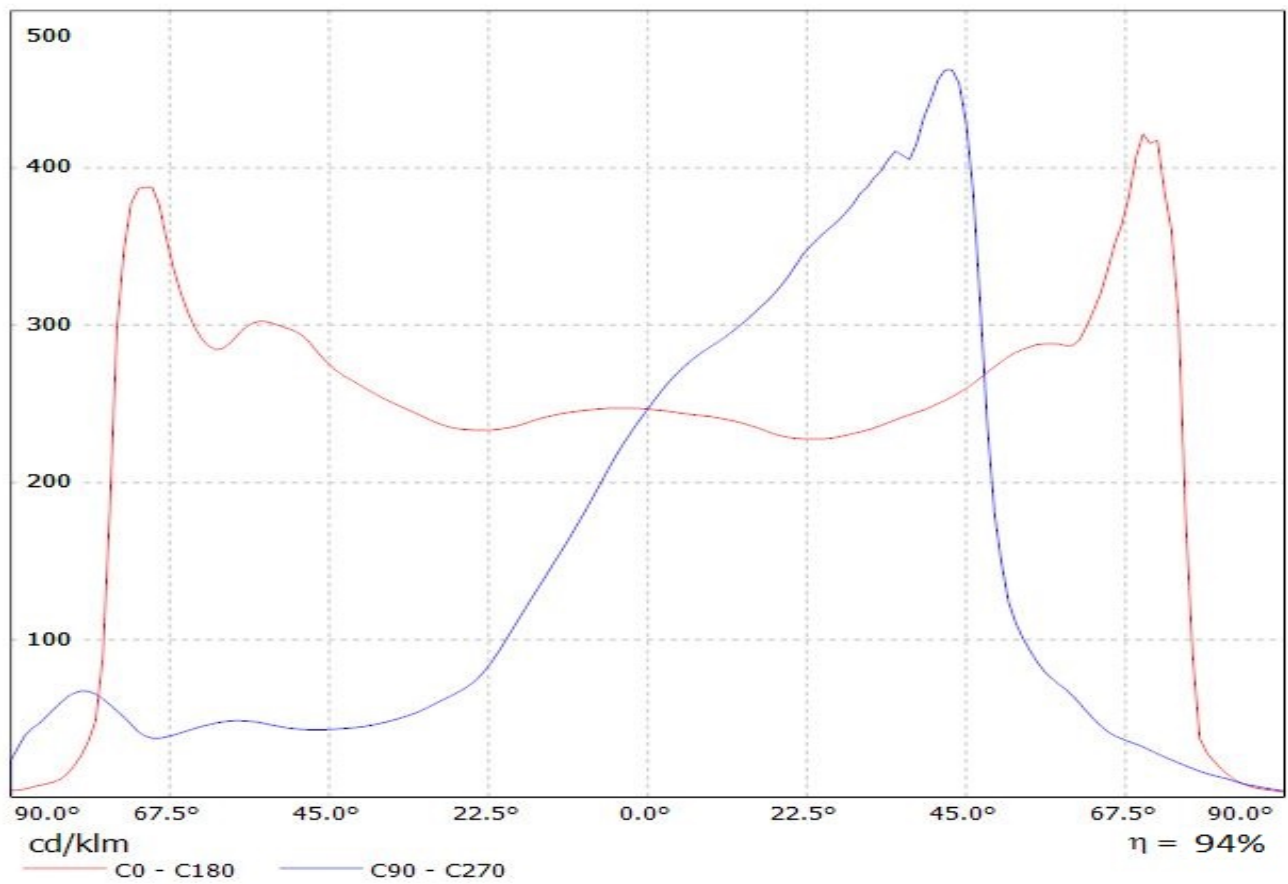

Luminaire: LEDiL Oy C13299_STRADA-2X2-ME_(Tridonic_Module_RLE_G1)
Lamps: 1 x Tridonic_Module_RLE_G1_2288lm@700mA_P=16W_I=0.700A

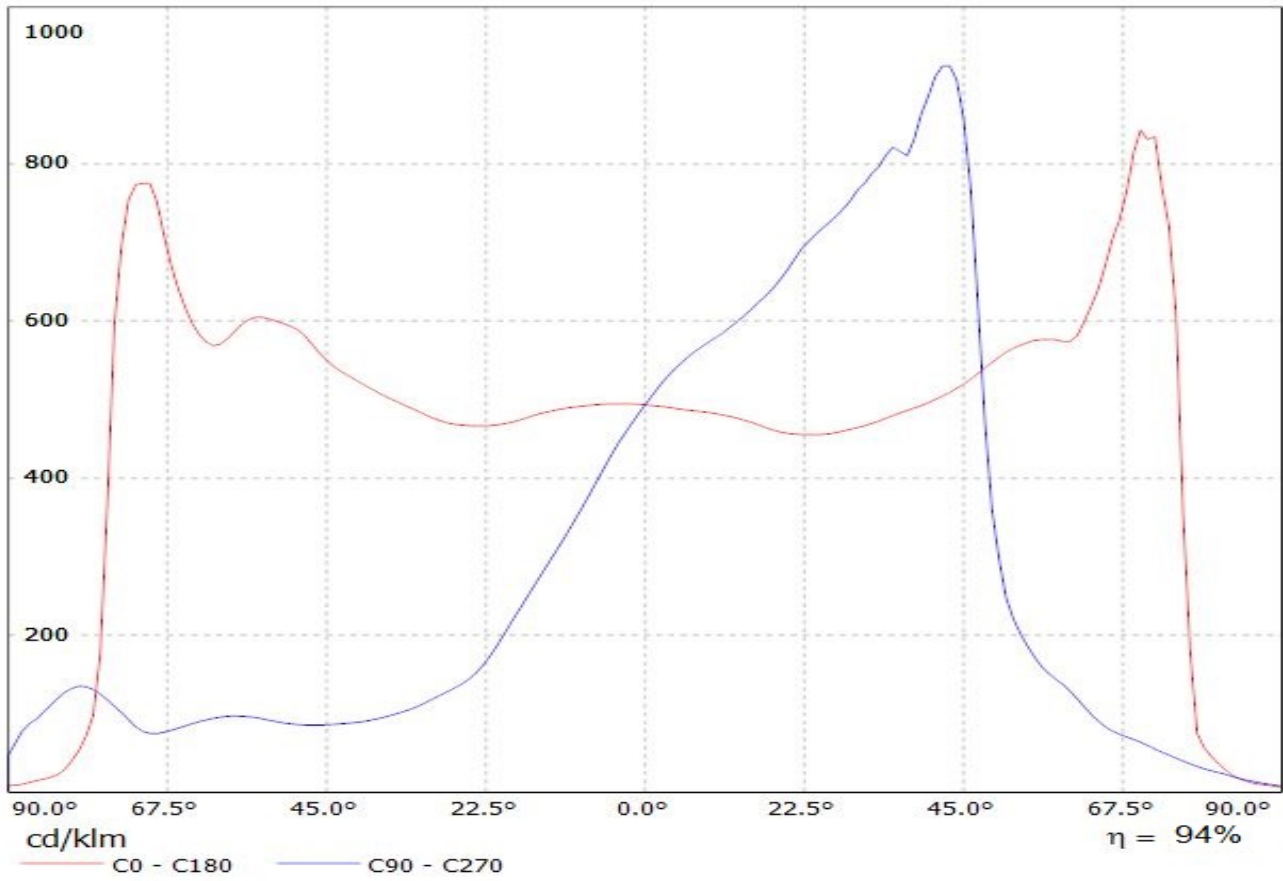

Luminaire: LEDiL Oy C13299_STRADA-2X2-ME_(Tridonic_Module_RLE_G1)
Lamps: 1 x Tridonic_Module_RLE_G1_2288lm@700mA_P=16W_I=0.700A

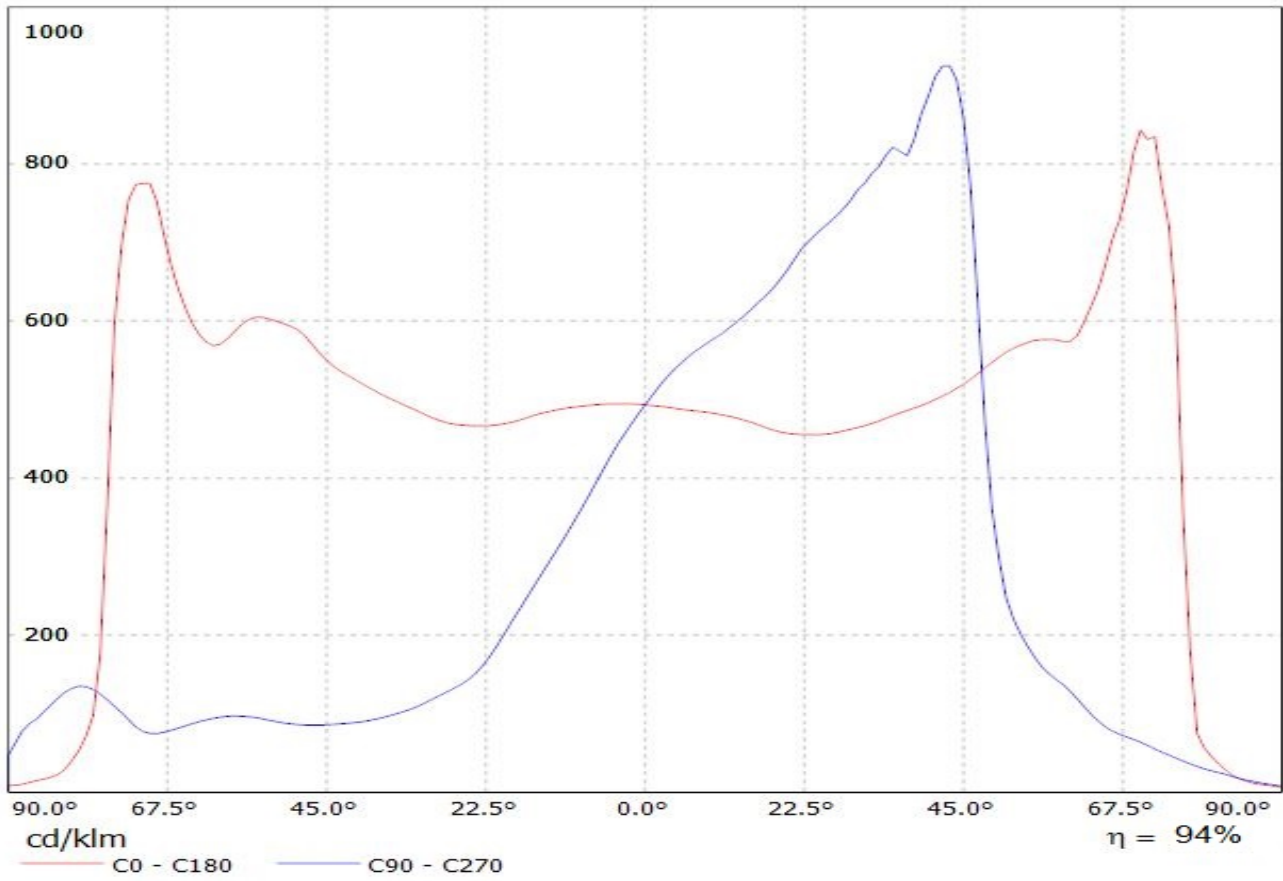

Luminaire: LEDiL Oy C13299_STRADA-2X2-ME_(XT-E)_3 Eff.94.0%
Lamps: 1 x CREE_XT-E_385.199lm@250mA_CCT=5717K

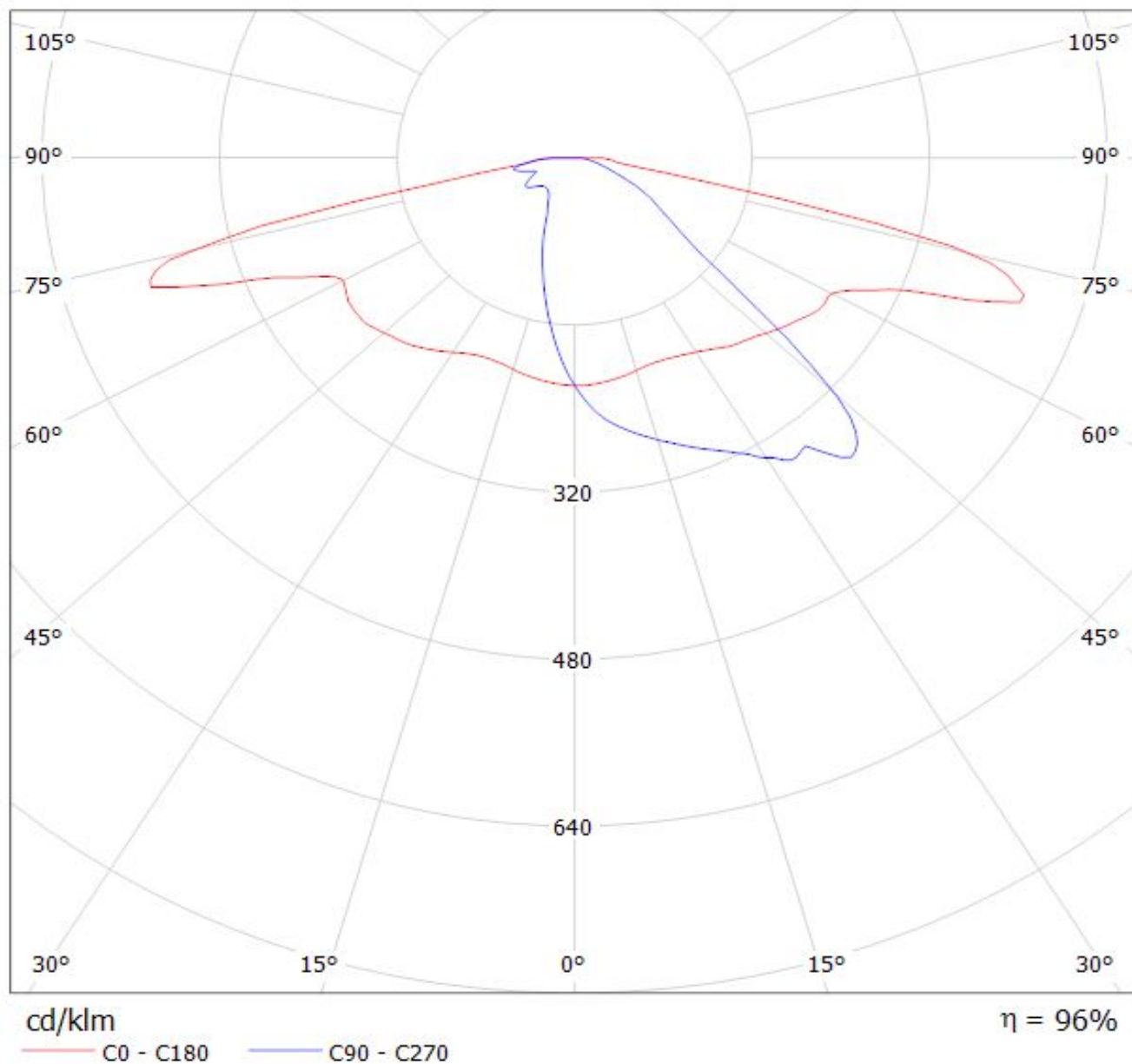

LEDiL Oy C13299_STRADA-2X2-ME_(XM-L) Eff.94.0% / LDC (Polar)

Luminaire: LEDiL Oy C13299_STRADA-2X2-ME_(XM-L) Eff.94.0%
Lamps: 1 x XM-L_2x2_360.4lm@250mA_P=2.82462W_I=249.9mA

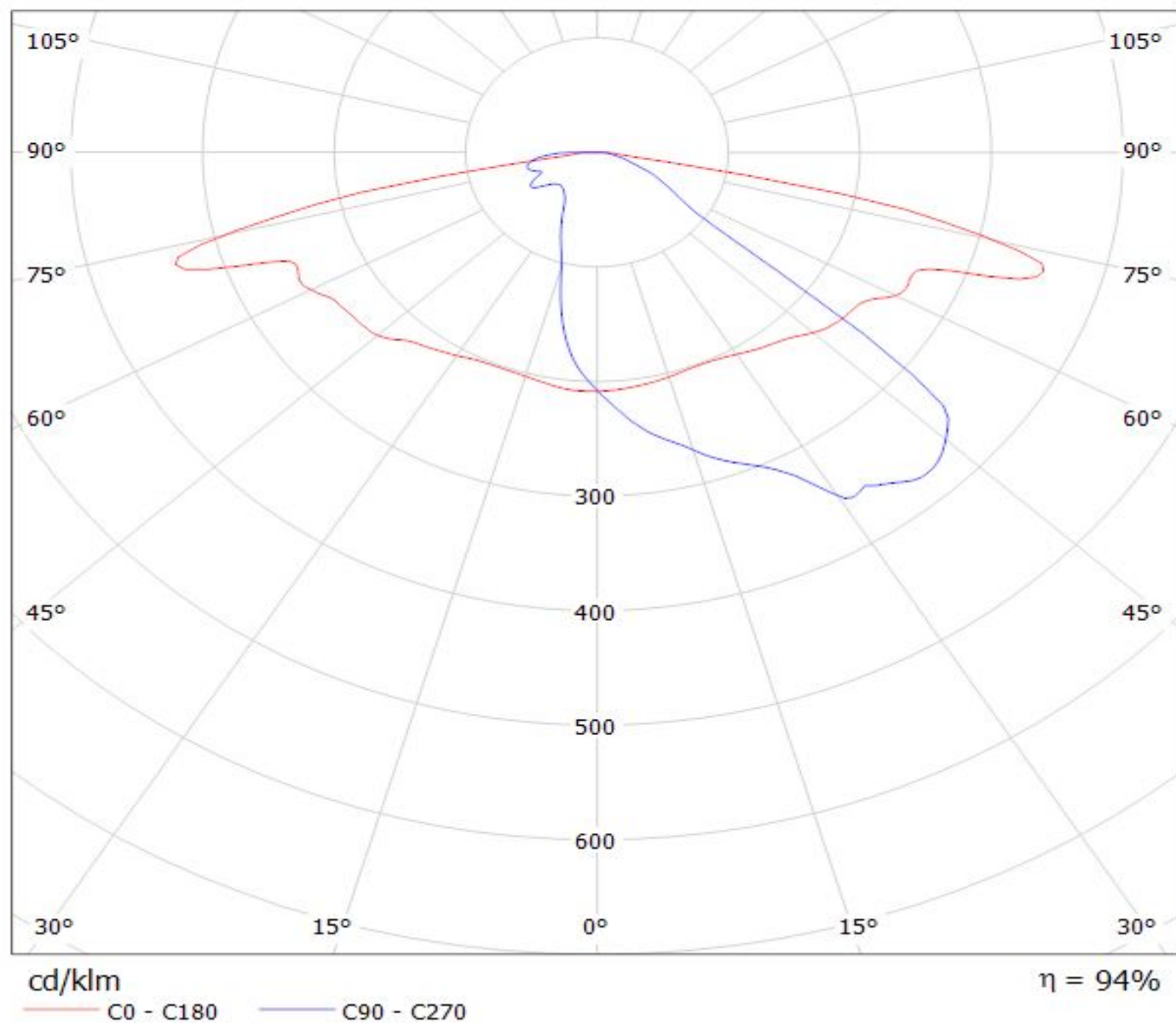

LEDiL Oy C13299_STRADA-2X2-ME_(XB-D) Eff.94.0% / LDC (Polar)

Luminaire: LEDiL Oy C13299_STRADA-2X2-ME_(XB-D) Eff.94.0%
Lamps: 1 x XB-D_2x2_368.85lm@250mA_P=3.06227W_I=249.9mA

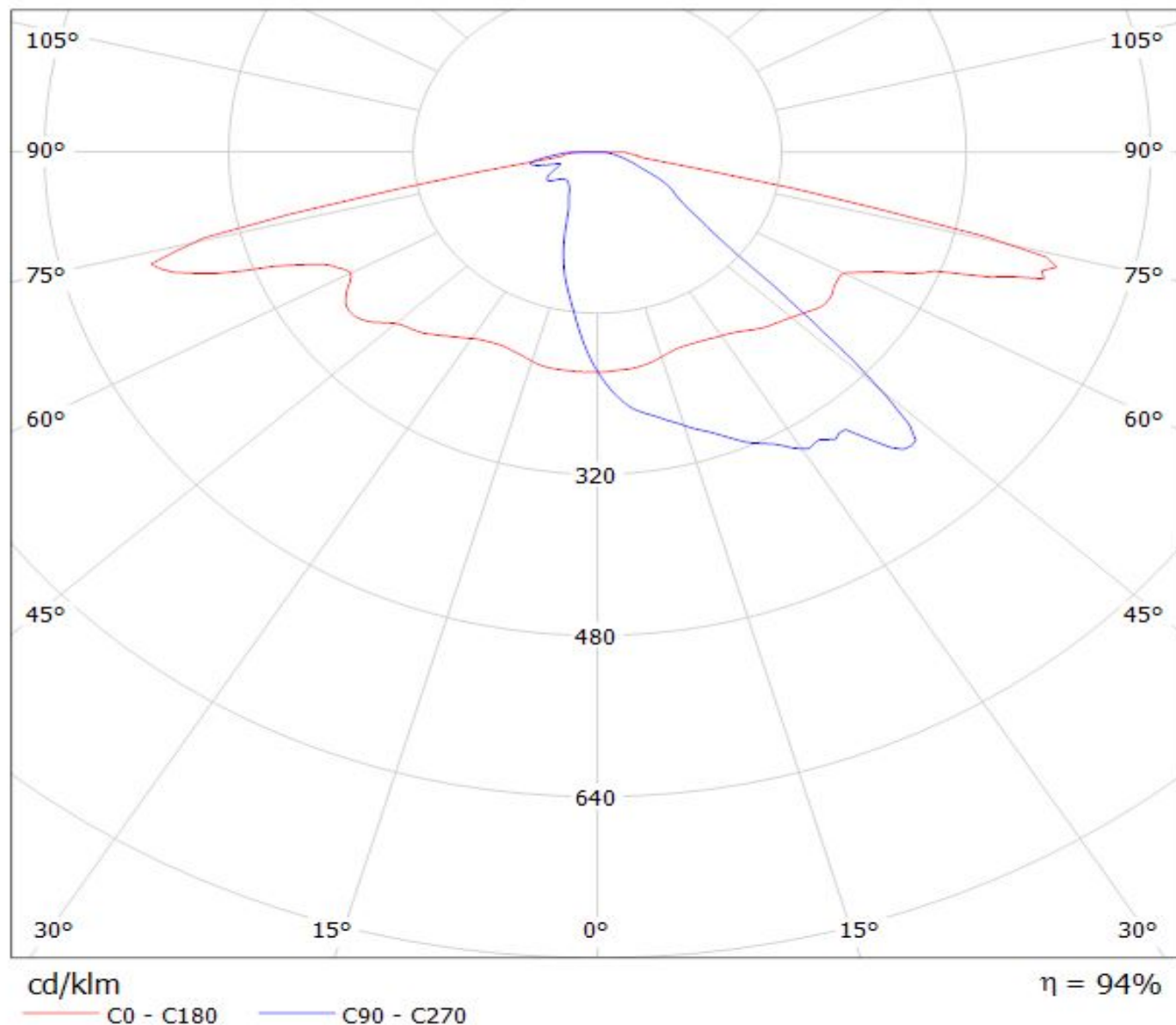

LEDiL Oy C13299_STRADA-2X2-ME_(XP-G2) Eff.94.0% / LDC (Polar)

Luminaire: LEDiL Oy C13299_STRADA-2X2-ME_(XP-G2) Eff.94.0%

Lamps: 1 x XP-G2_2x2_(XPGBWT-L1-000-00G51)

_418.9lm@250mA_CCT=7181K_P=2.93358W_I=249.9mA

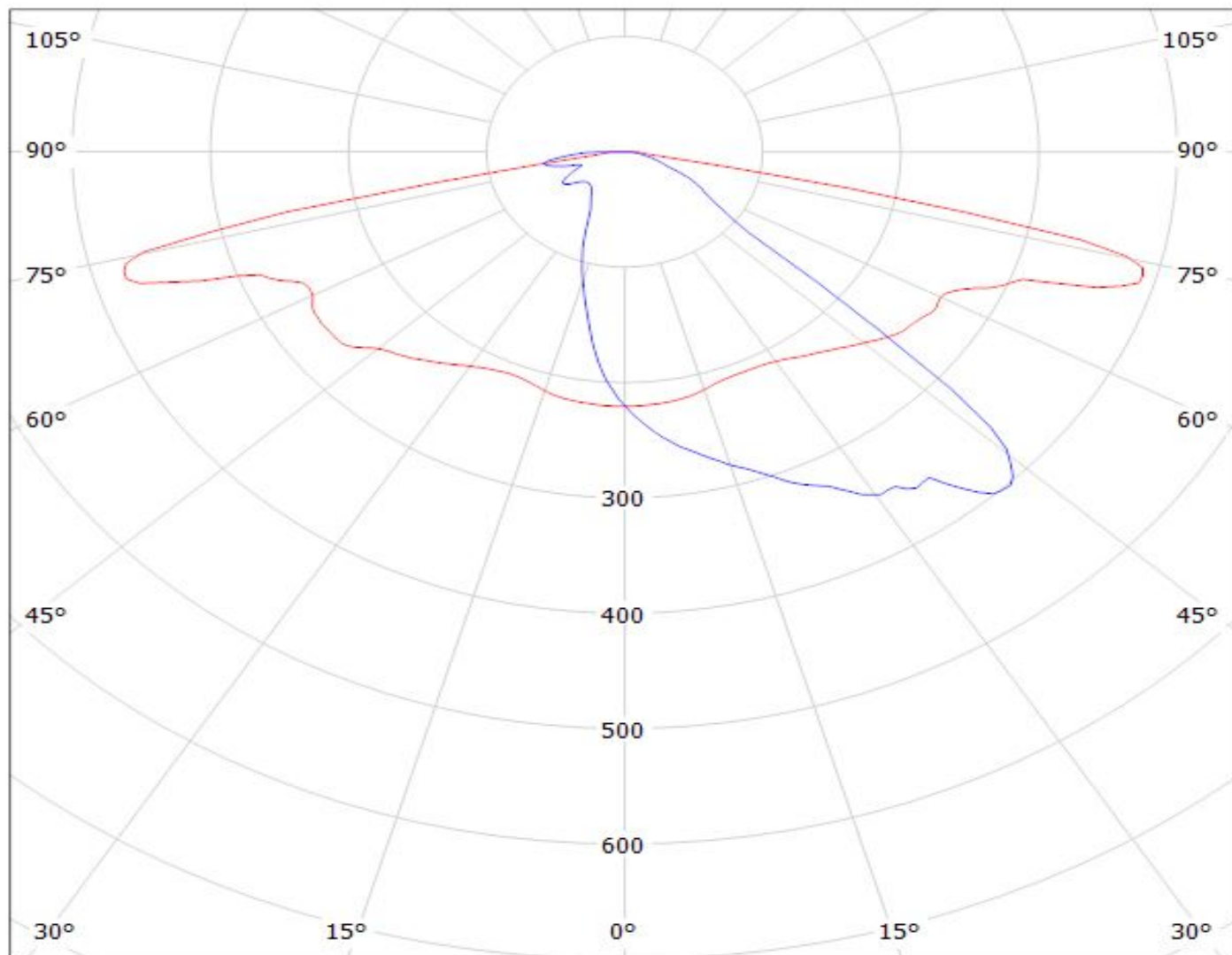

cd/klm

— C0 - C180

— C90 - C270

$\eta = 94\%$

LEDiL Oy C13299_STRADA-2X2-ME_(XP-G) / LDC (Polar)

Luminaire: LEDiL Oy C13299_STRADA-2X2-ME_(XP-G)

Lamps: 1 x XP-G_2x2_258.35lm@250mA_P=2.88734W_I=249.9mA

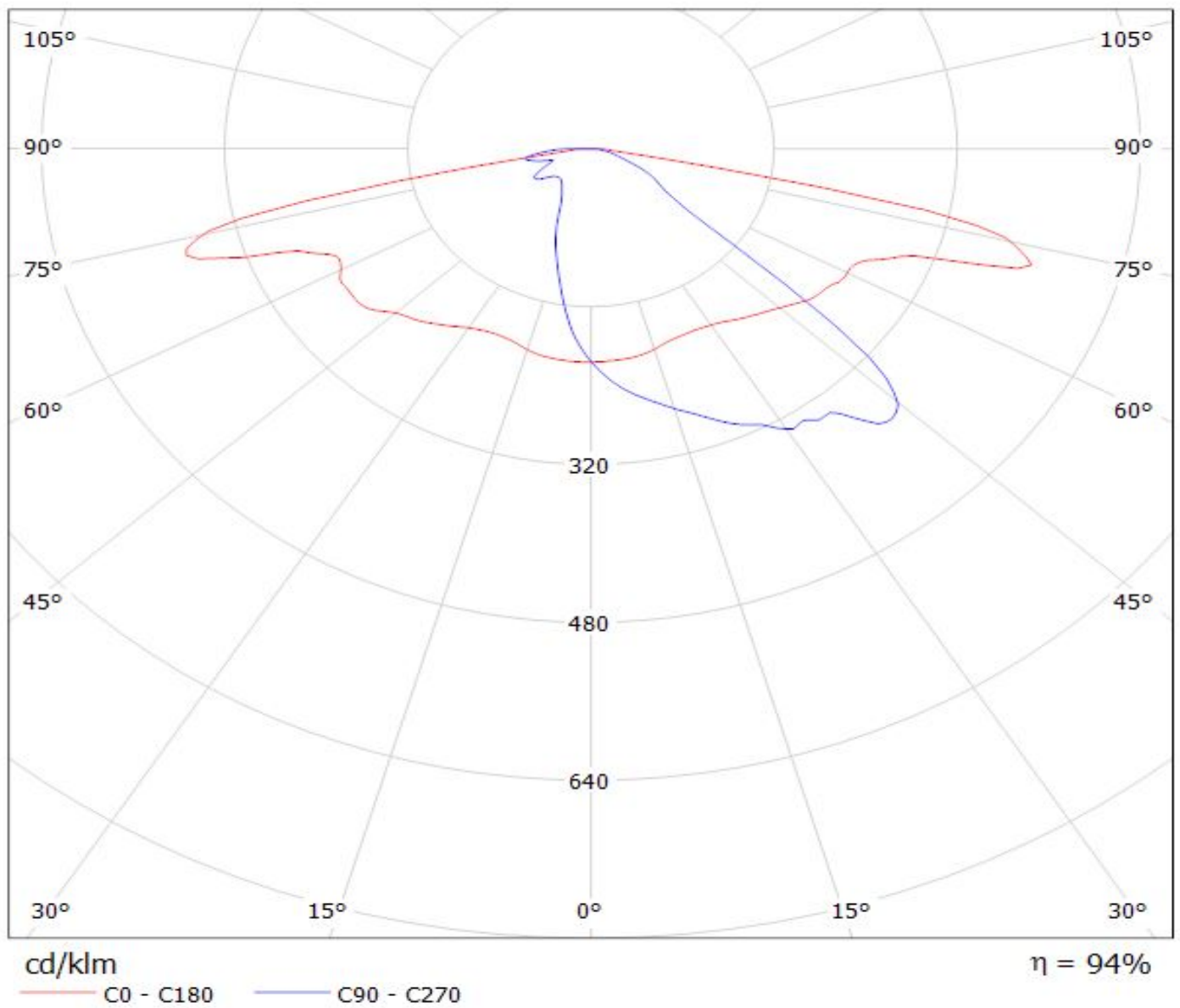

LEDiL Oy C13299_STRADA-2X2-ME_(XP-E2) Eff.94.0% / LDC (Polar)

Luminaire: LEDiL Oy C13299_STRADA-2X2-ME_(XP-E2) Eff.94.0%

Lamps: 1 x CREE_XP-E2_2x2_(XPEBWT-L1-7B4-Q4-0-01)

_341.05lm@250mA_P=2.92366W_I=249.8mA

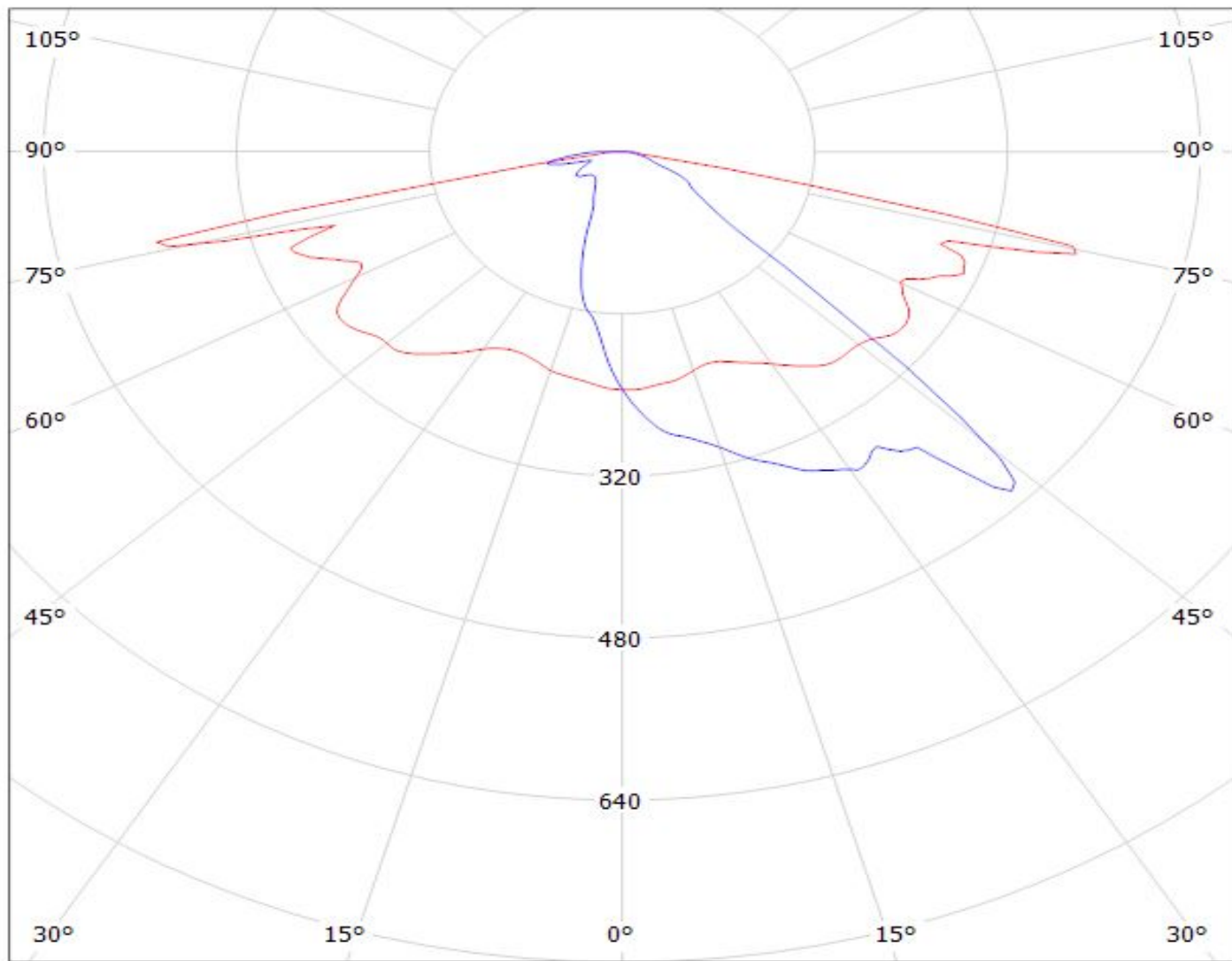

cd/klm

— C0 - C180

— C90 - C270

$\eta = 94\%$

Luminaire: LEDil Oy C13299_STRADA-2X2-ME_(XM-L2) Efficiency=94%
Lamps: 1 x Cree XM-L2 (XMLBWT-0-7B4-T30-0L-0001) 356lm @ 250mA CCT=3200K P=2.8W I=250mA

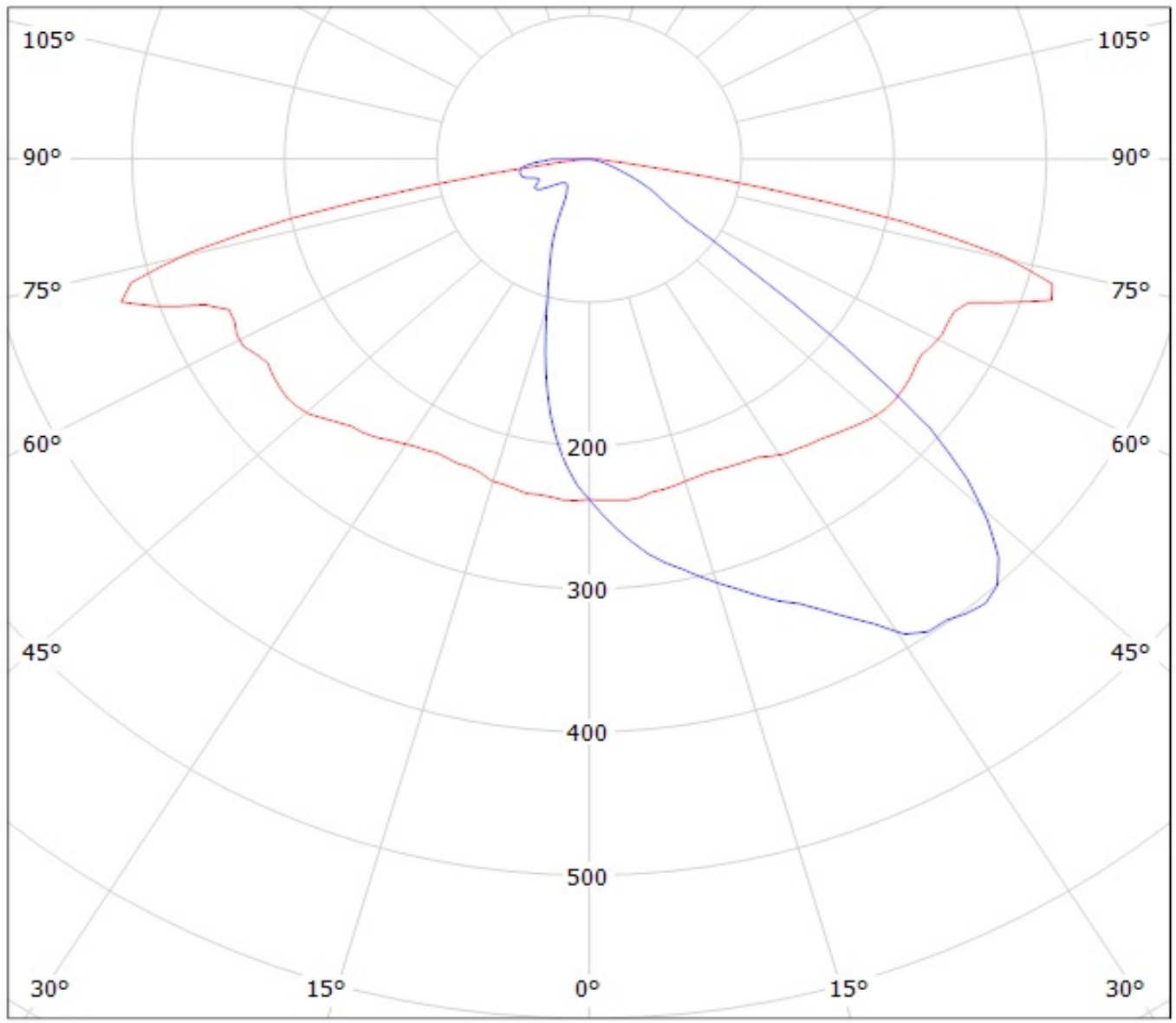

cd/klm
— C0 - C180 — C90 - C270

Luminaire: LEDiL Oy C13299_STRADA-2X2-ME_(XP-L)

Lamps: 1 x CREE_XP-L_2x2_(XPLAWT-0-1B0-V40-00-0001)_518.95lm@250mA_CCT=7600K_P=2.79963W_I=249.9mA

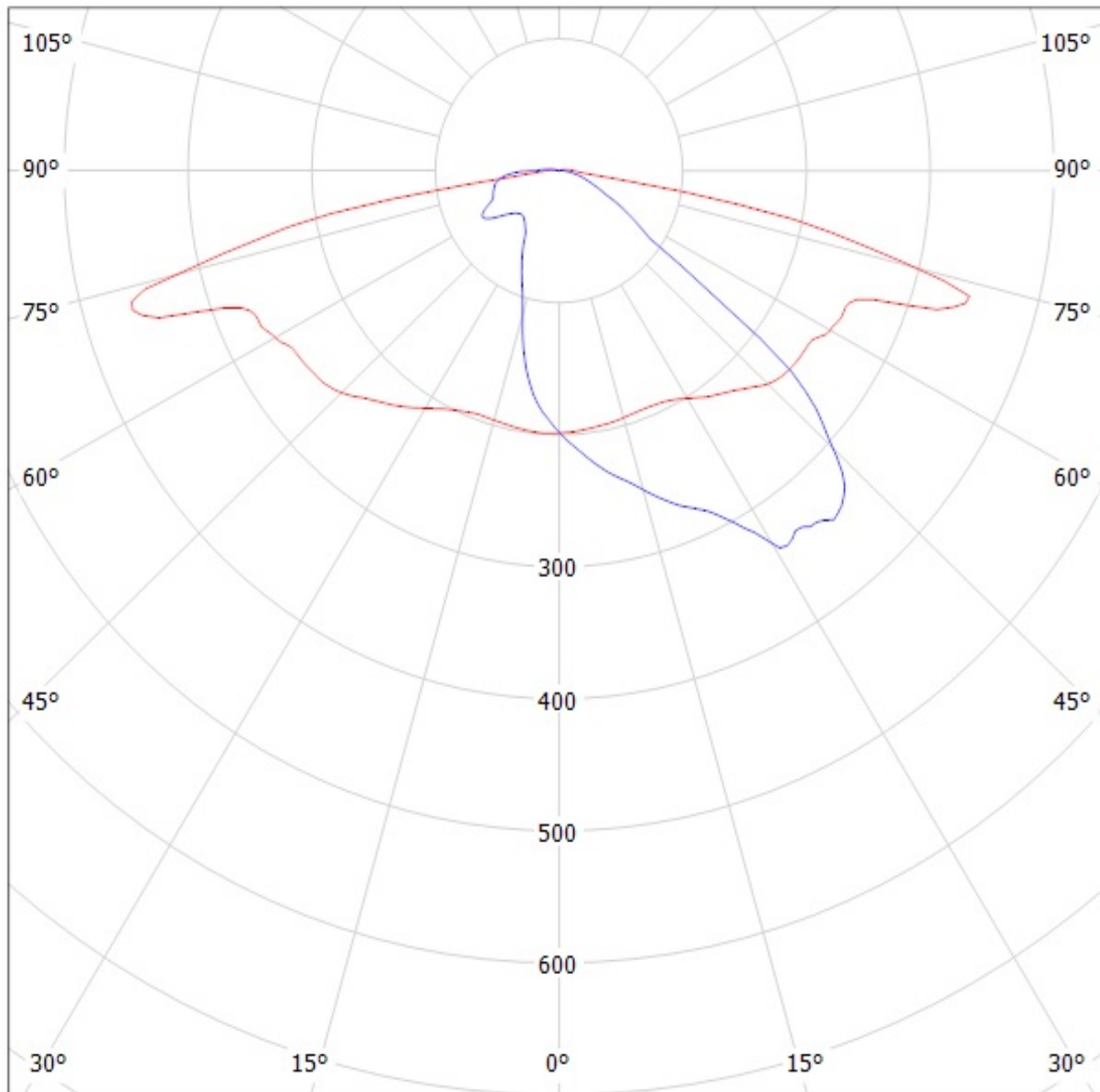

cd/klm

— C0 - C180 — C90 - C270

$\eta = 94\%$

Luminaire: LEDiL Oy C13299_STRADA-2X2-ME_(XP-L_HI)
Lamps: 1 x Cree_XP-L_HI_(2x2)_(XPLAWT-H-5A3-U60-013-0001)
_455.077lm@250mA_P=2.84011W_I=0,2499A

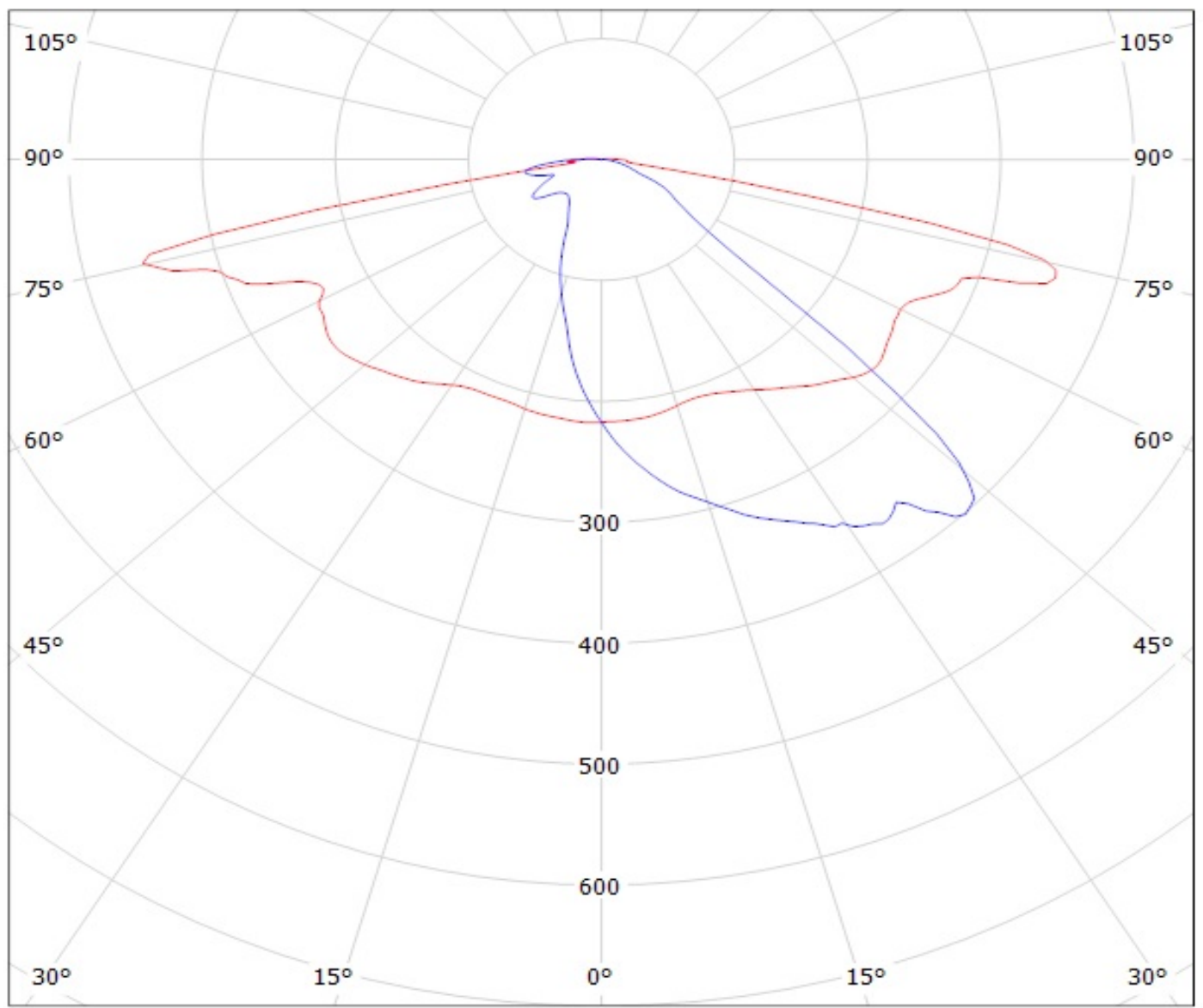

cd/klm

— C0 - C180 — C90 - C270

$\eta = 96\%$

Luminaire: Ledil Oy C13299_STRADA-2X2-ME_CREE_XP-G3_SIMULATED
Lamps: 1 x CREE XP-G3

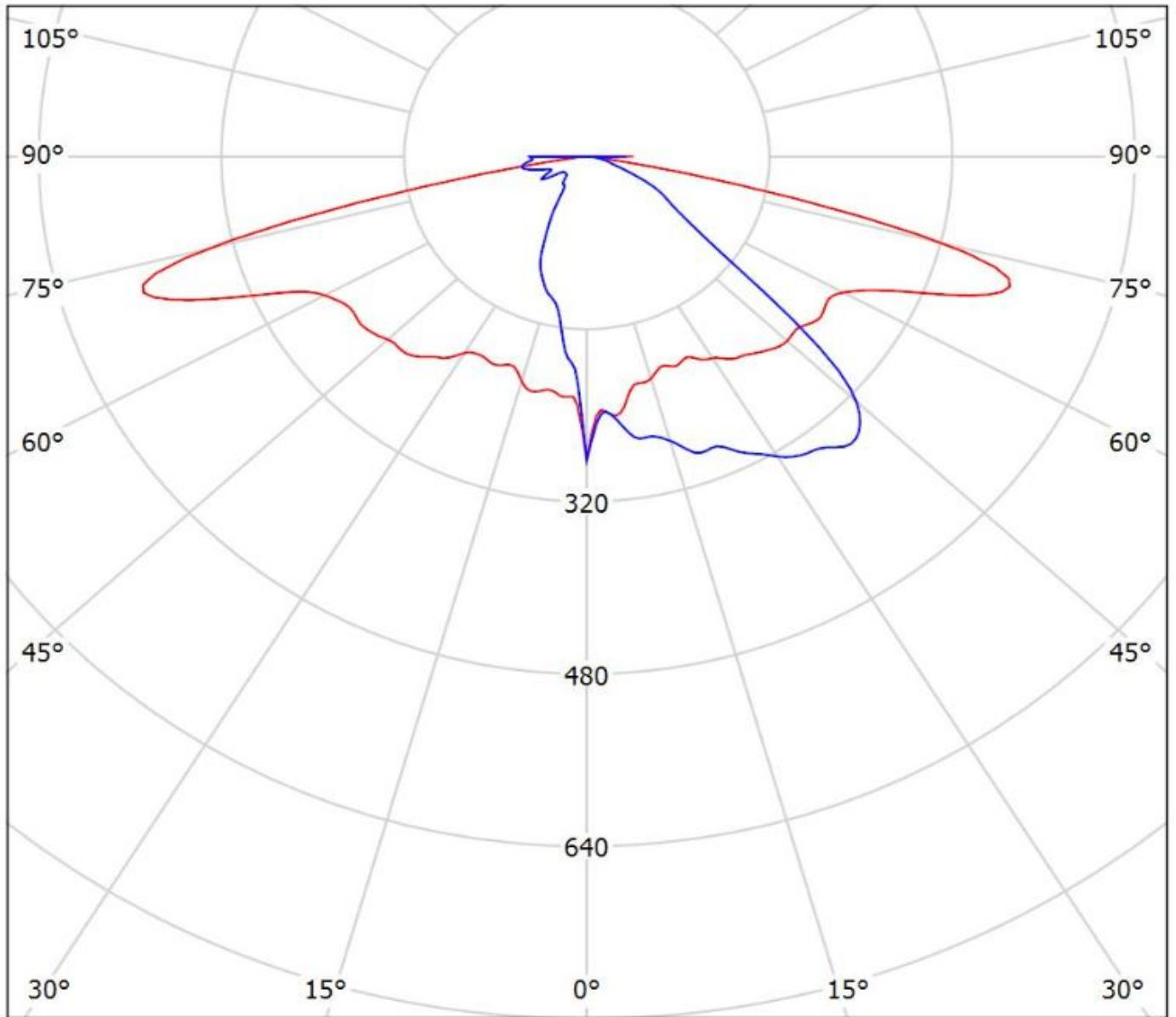

cd/klm
— C0 - C180 — C90 - C270

$\eta = 93\%$

Luminaire: Ledil C13299_STRADA-2X2-ME_(XP-L2)

Lamps: 1 x Cree_XP-L2_2x2_(XPLBWT-00-0000-000BV50E3)550.93lm@250mA_P=2.7815W_I=0.25A

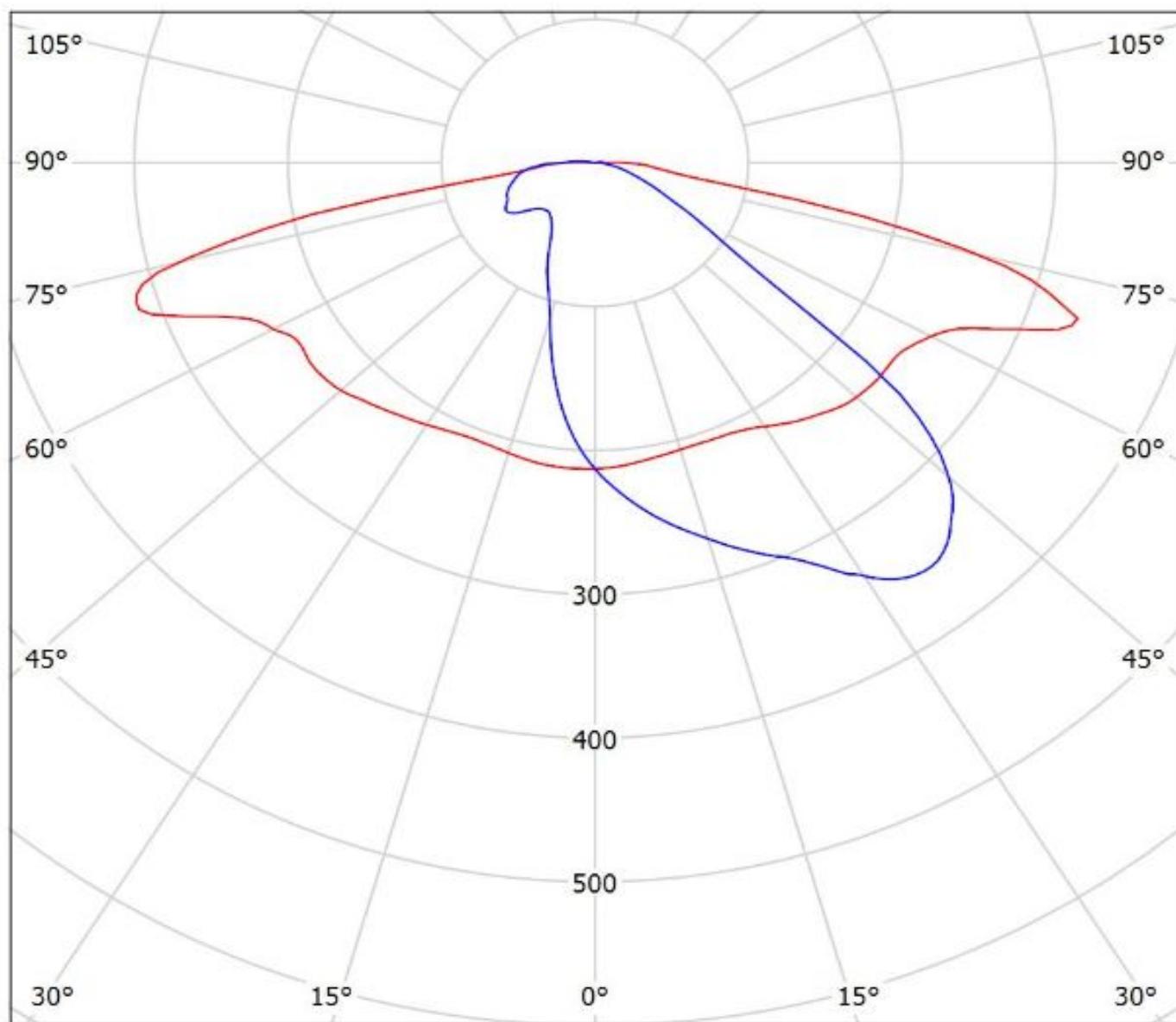

cd/klm

— C0 - C180 — C90 - C270

$\eta = 97\%$

**LEDiL Oy C13299_STRADA-2X2-ME_(LG-3535-CERAMIC-GEN2) Eff.94.0% /
LDC (Polar)**

Luminaire: LEDiL Oy C13299_STRADA-2X2-ME_(LG-3535-CERAMIC-GEN2) Eff.94.0%

Lamps: 1 x LG-3535-CERAMIC-GEN2_2x2_475.9lm@250mA_P=2.8651W_CCT=6562K_I=249.9mA

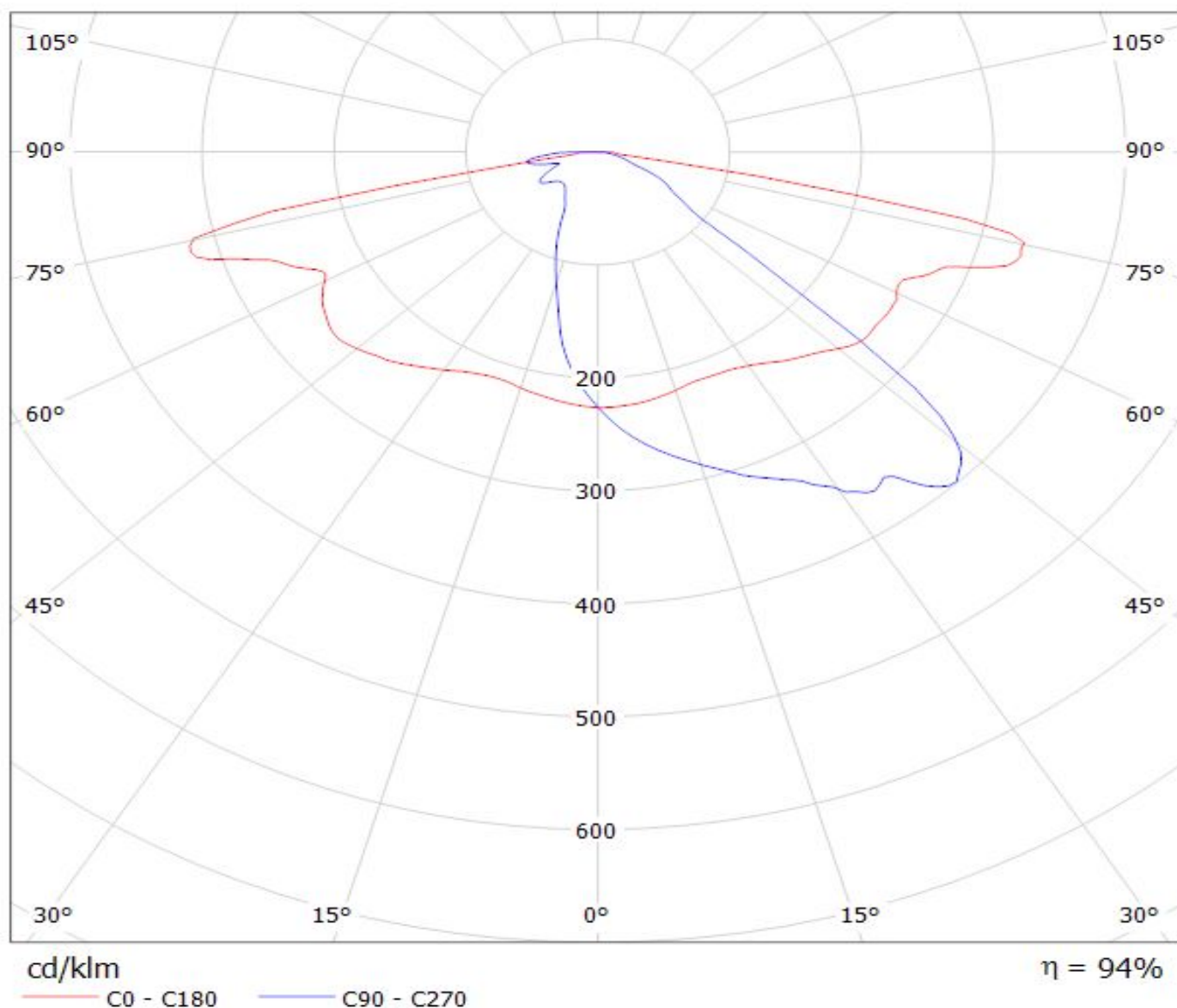

LEDiL Oy C13299_STRADA-2X2-ME_(Luxeon-R) Eff.94.0% / LDC (Polar)

Luminaire: LEDiL Oy C13299_STRADA-2X2-ME_(Luxeon-R) Eff.94.0%

Lamps: 1 x Luxeon_R_2x2_(LXA7-PW30)_314.75lm@250mA_P=2.77914W_I=249.9mA

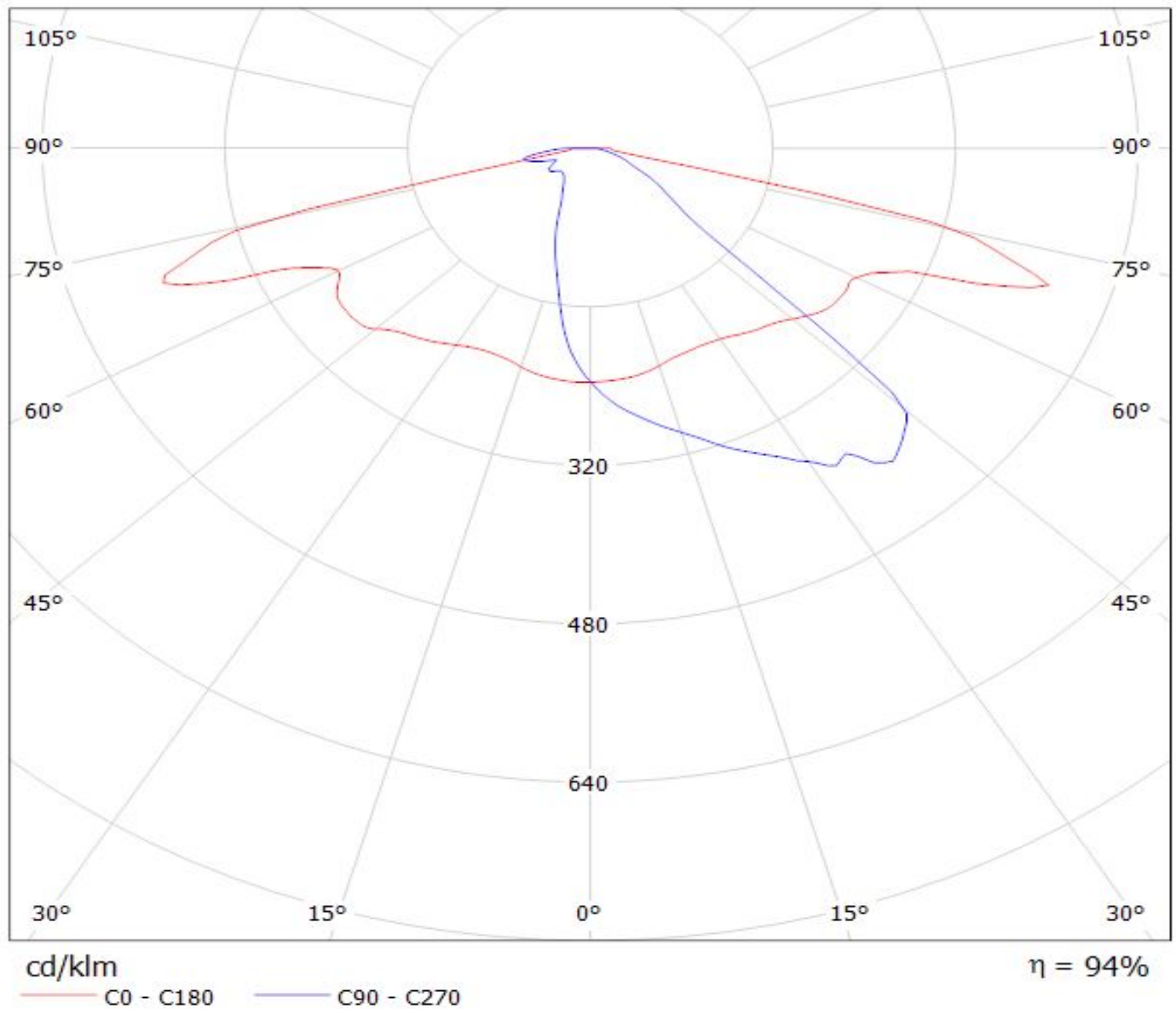

LEDiL Oy C13299_STRADA-2X2-ME_(Rebel-ES) Eff.94.0% / LDC (Polar)

Luminaire: LEDiL Oy C13299_STRADA-2X2-ME_(Rebel-ES) Eff.94.0%

Lamps: 1 x Luxeon_Rebel-ES_2x2_341.5lm@250mA_P=2.86485W_I=249.9mA

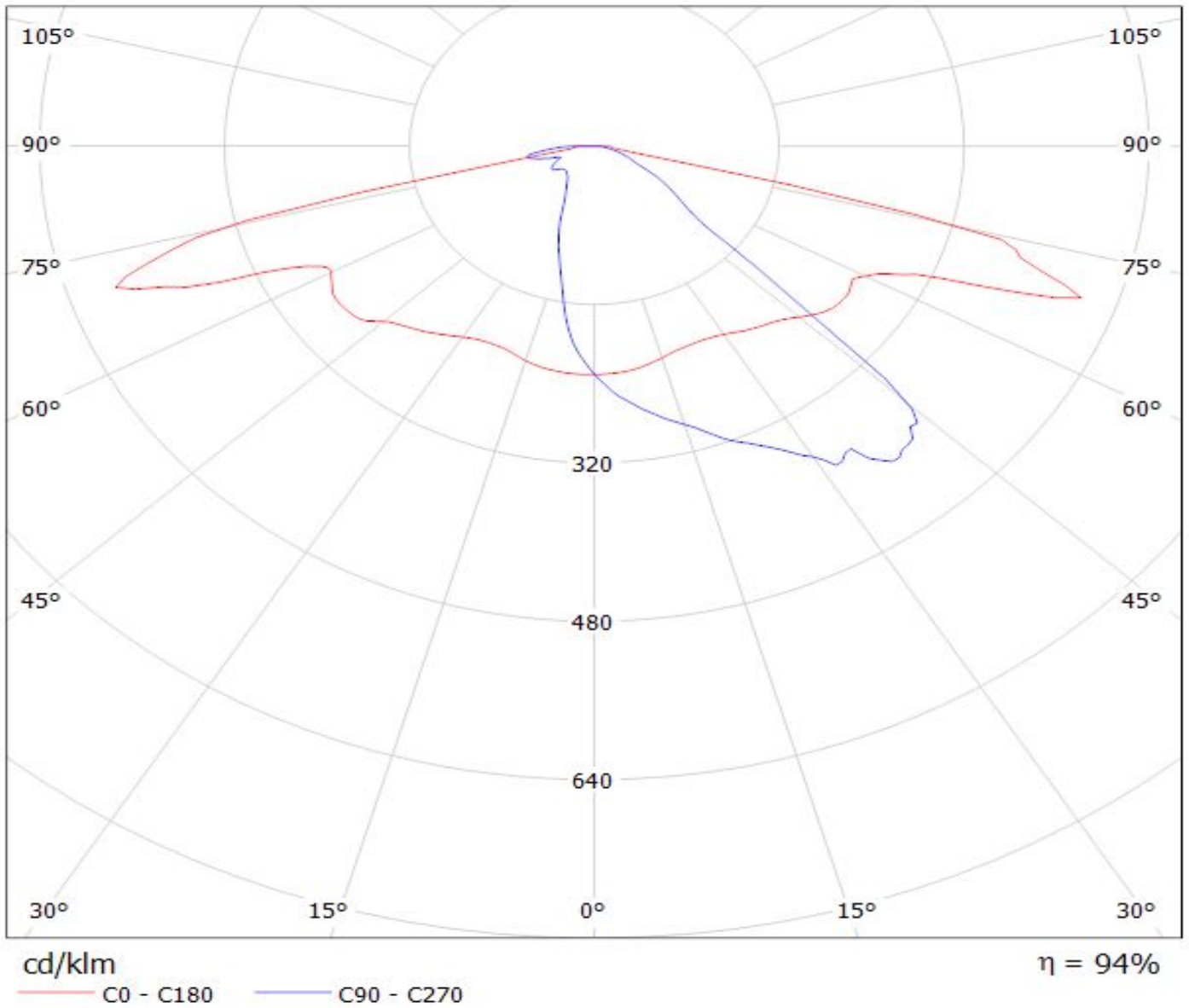

Luminaire: LEDiL Oy C13299_STRADA-2x2-ME_(Luxeon_T)
Lamps: 1 x Luxeon T (LXH8-FW30-3) 303lm@250mA P=2.80138W I=0.2499A

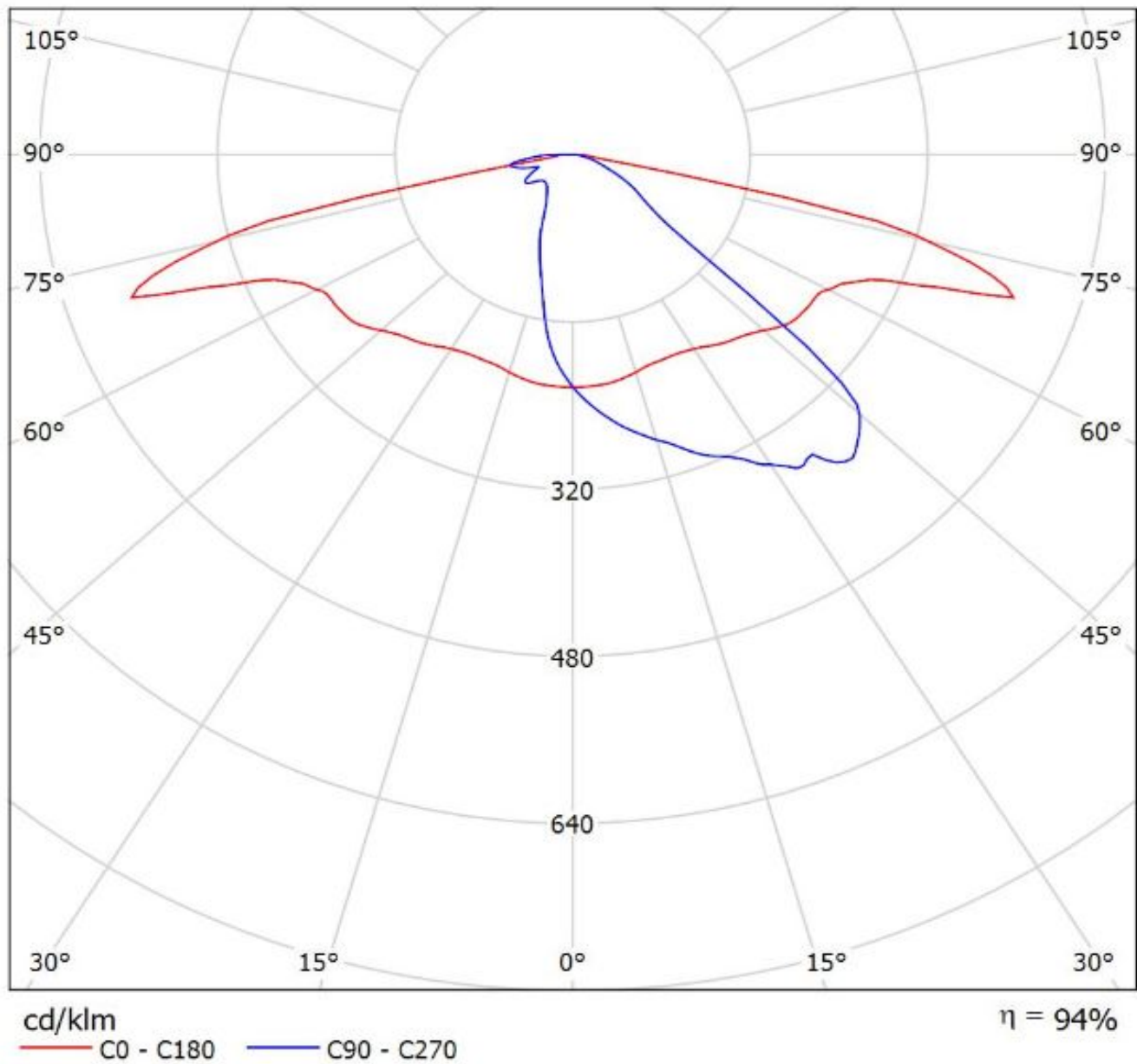

Luminaire: LEDiL Oy C13299_STRADA-2x2-ME_(Luxeon_Z_ES) Eff. 94%
Lamps: 1 x Luxeon_Z_ES_2x2_(LXZ2-3090)_210.126lm@250mA_P=2.81862W_I=249.9mA

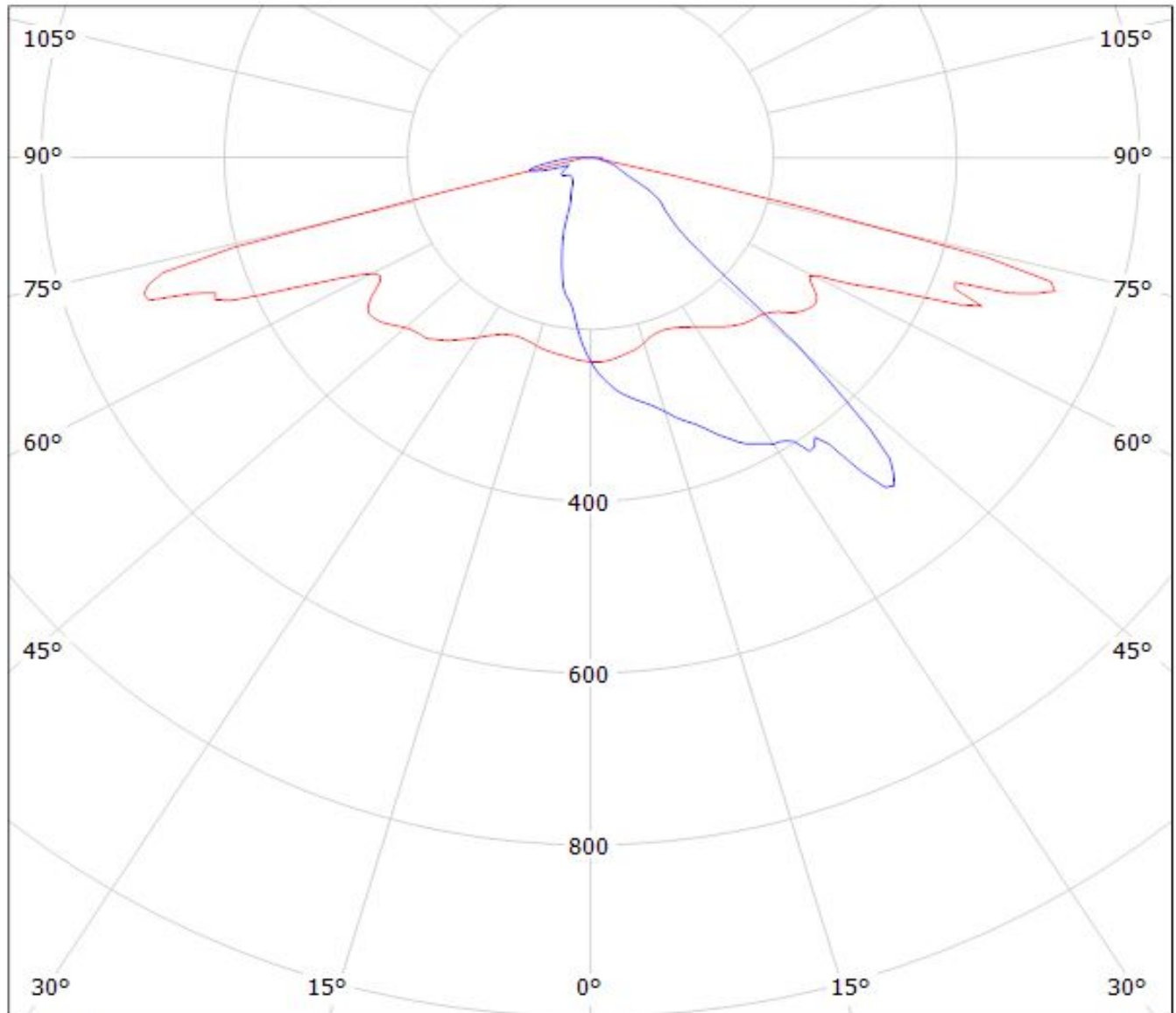

cd/klm

— C0 - C180 — C90 - C270

$\eta = 96\%$

Luminaire: LEDiL Oy C13299_STRADA-2X2-ME_(LUXEON_Q)

Lamps: 1 x LUXEON_Q_2x2_(LHQ-3080)_298.615lm@250mA_P=2.86995W_I=249.8mA

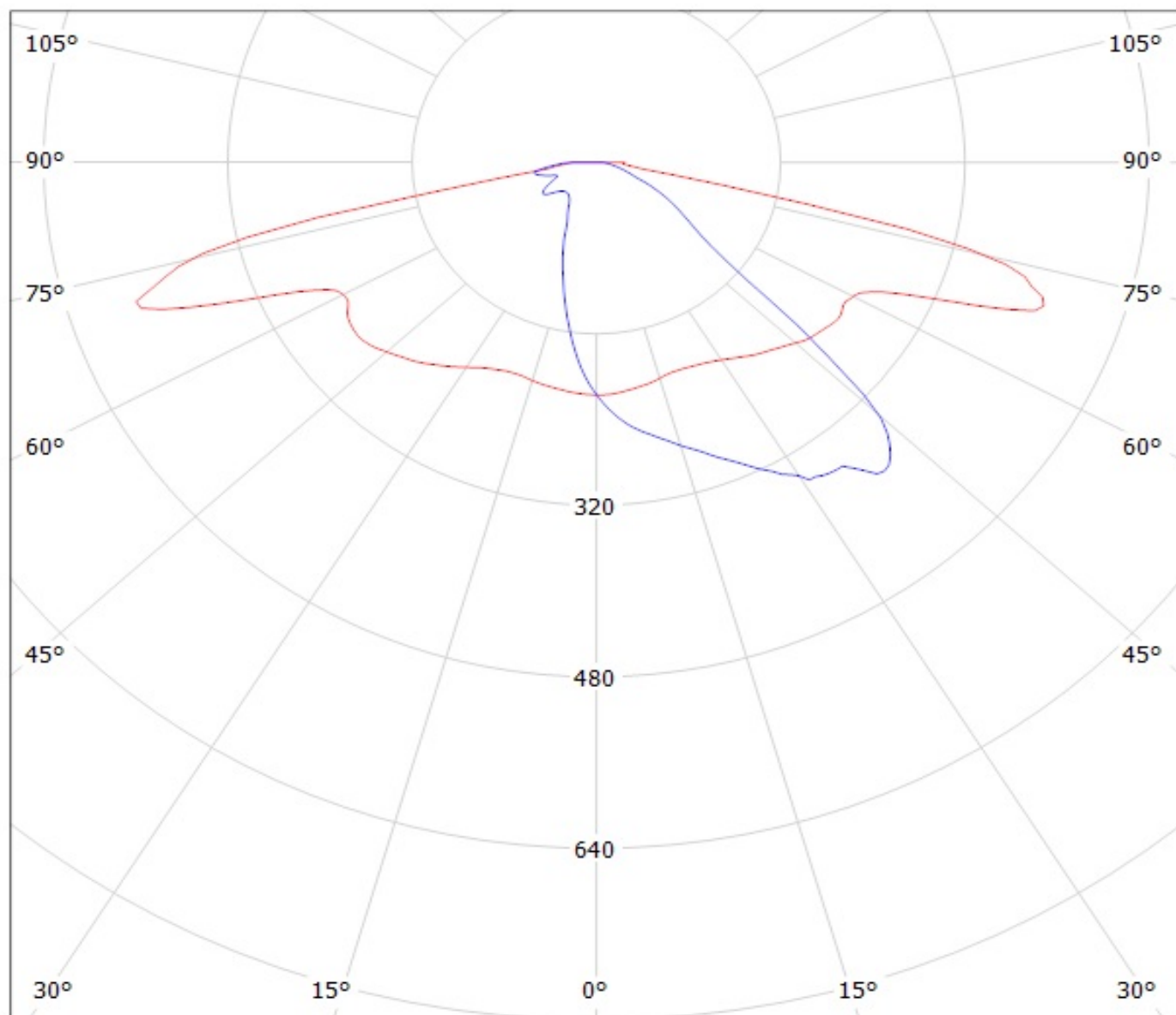

cd/klm

— C0 - C180

— C90 - C270

Luminaire: LEDiL Oy C13299_STRADA-2X2-ME_(LUXEON_MZ) Eff.94.0%

Lamps: 1 x LUXEON_MZ_2x2_(LMZ7-QW57)_419.8lm@250mA_P=2.71916W_CCT=5700K_I=249.9mA

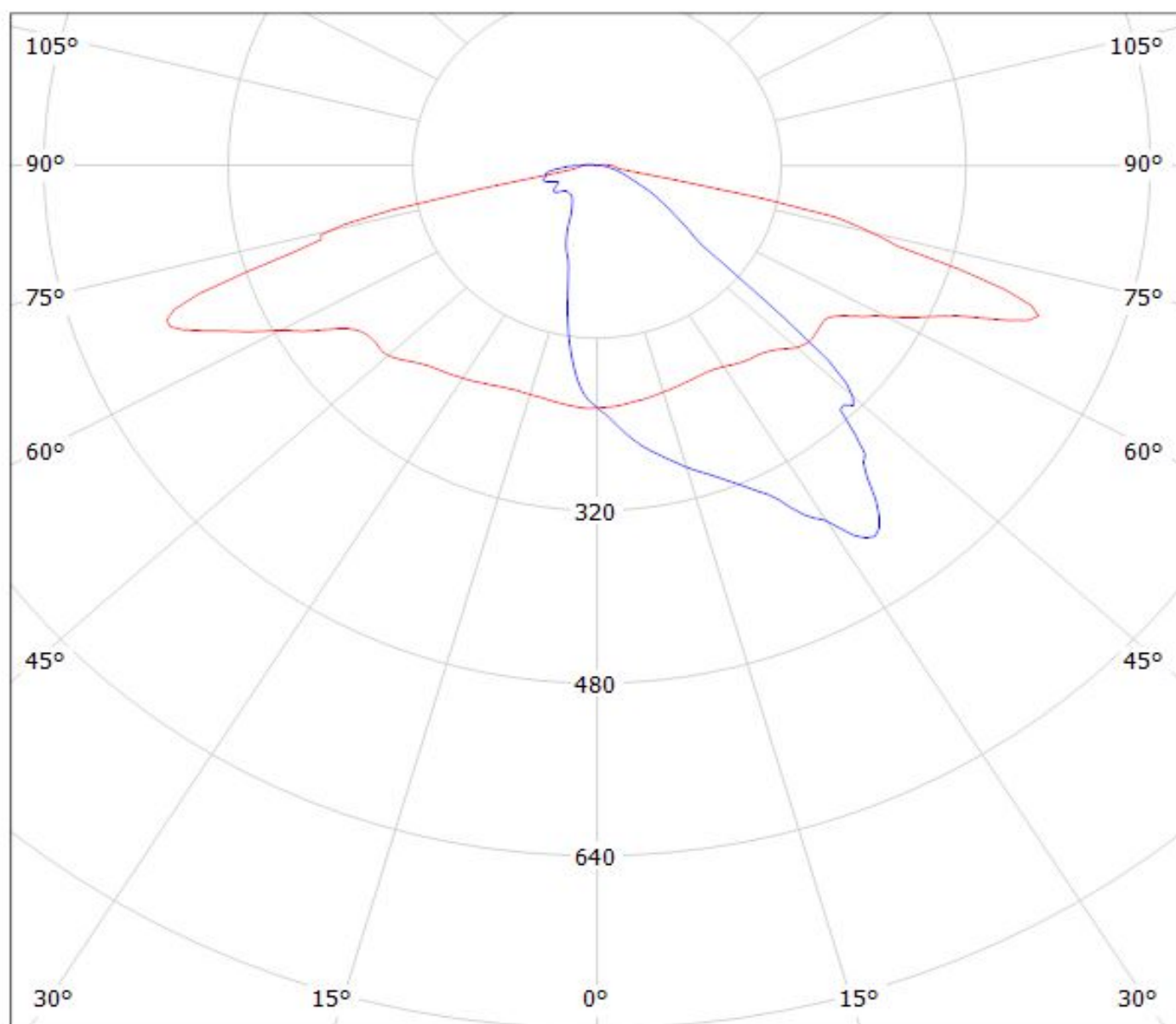

cd/klm

— C0 - C180

— C90 - C270

$\eta = 94\%$

Luminaire: Ledil C13299_STRADA-2X2-ME_(Luxeon_TX)

Lamps: 1 x Luxeon_TX_2x2_(L1T2-3585)_331.643lm@250mA_P=3W_I=0.25A

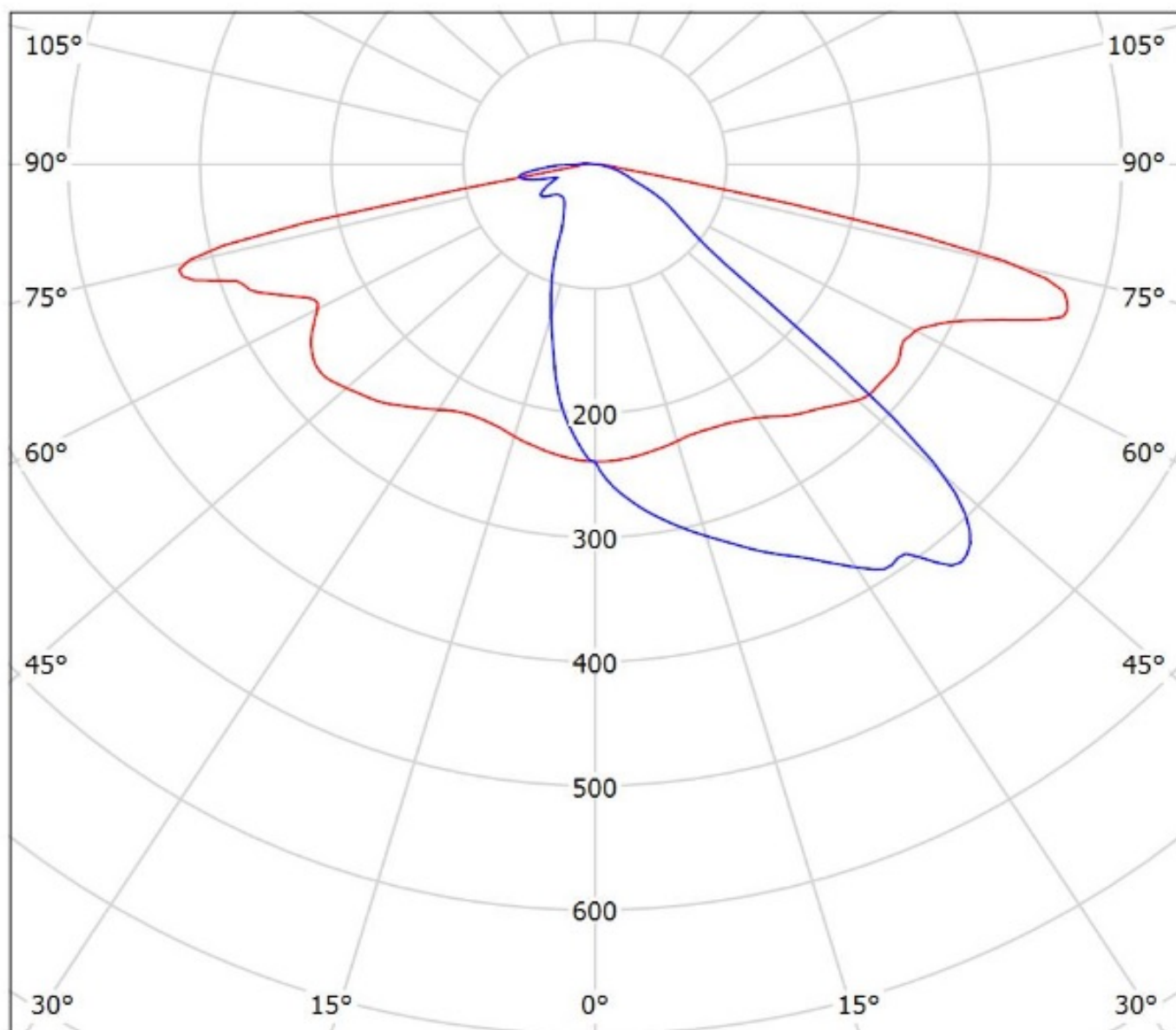

cd/klm

— C0 - C180

— C90 - C270

$\eta = 96\%$

Luminaire: LEDiL Oy C13299_STRADA-2X2-ME_(Luxeon_5050)

Lamps: 1 x Luxeon_5050_2x2_1270.76lm@80mA_CCT=5700K_P=7.35815W_I=0.080A_70CRI

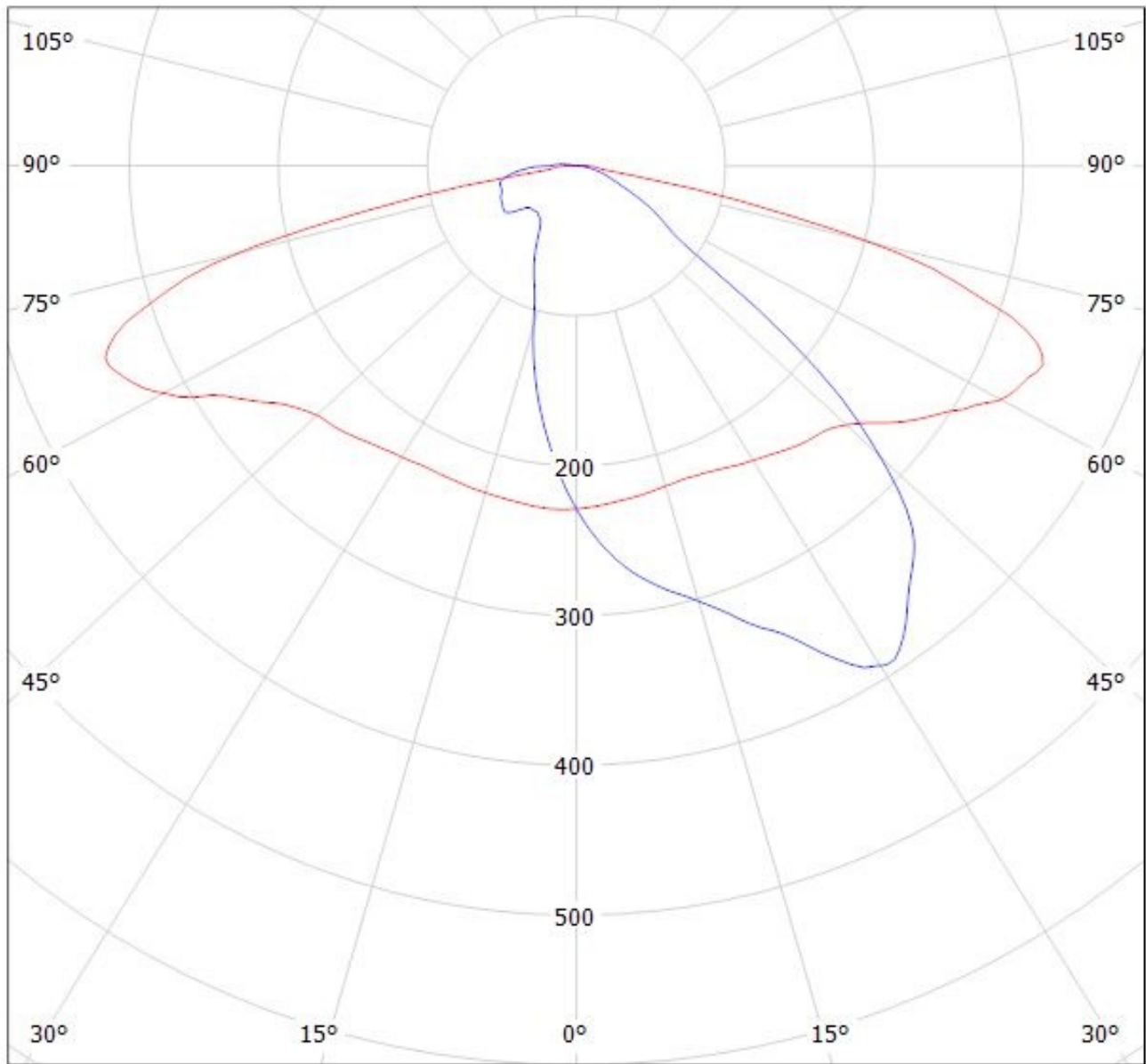

cd/klm

— C0 - C180

— C90 - C270

$\eta = 94\%$

LEDiL Oy C13299_STRADA-2X2-ME_(N383) Eff.94.0% / LDC (Polar)

Luminaire: LEDiL Oy C13299_STRADA-2X2-ME_(N383) Eff.94.0%

Lamps: 1 x NICHIA_N383_2x2_(NS9W383T)_376.958lm@250mA_P=2.88194W_I=249.9mA

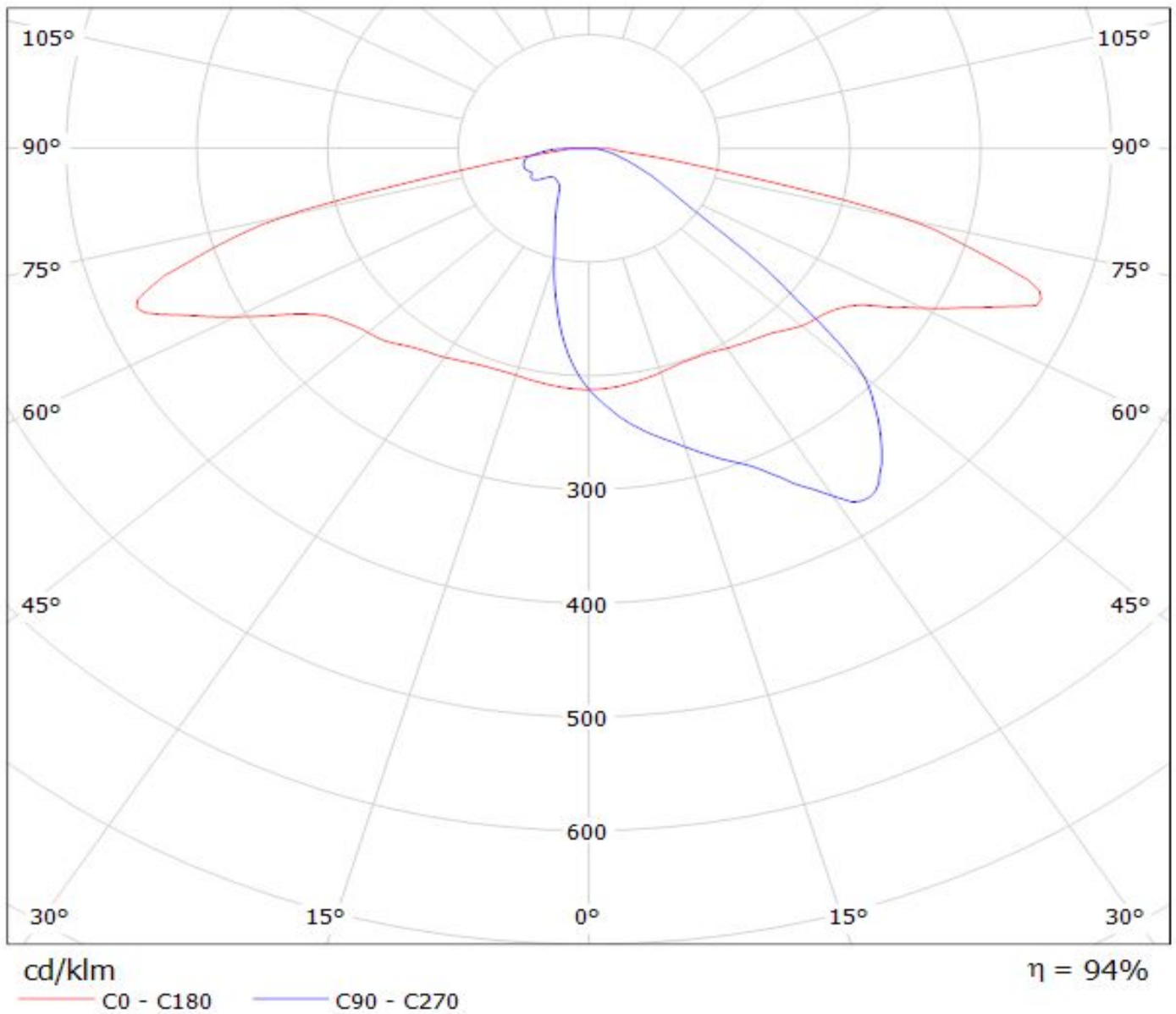

Luminaire: LEDiL Oy C13299_STRADA-2x2-ME_(NVSxx19B)

Lamps: 1 x Nichia_NVsxx19B_2x2_(NVSL219BE)_310.219lm@250mA_CCT=3071K_P=2.87735W_I=249.9mA

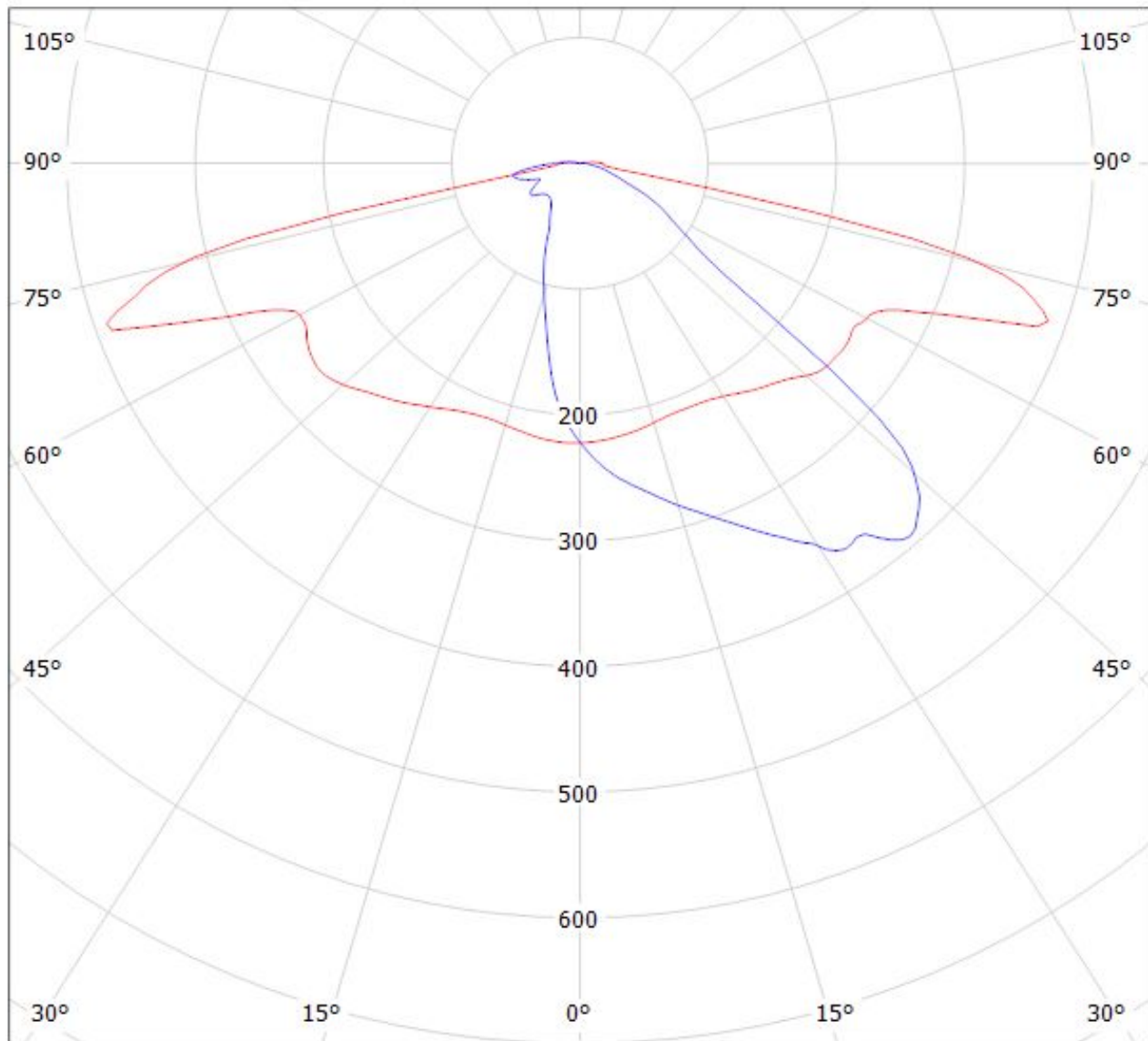

cd/klm

— C0 - C180

— C90 - C270

$\eta = 96\%$

Luminaire: LEDiL Oy C13299_STRADA-2X2-ME_(NWSL229AE)

Lamps: 1 x Nichia_2X2_NWSL229AE_476.548lm@250mA_P=2.7515W_I=0.250A

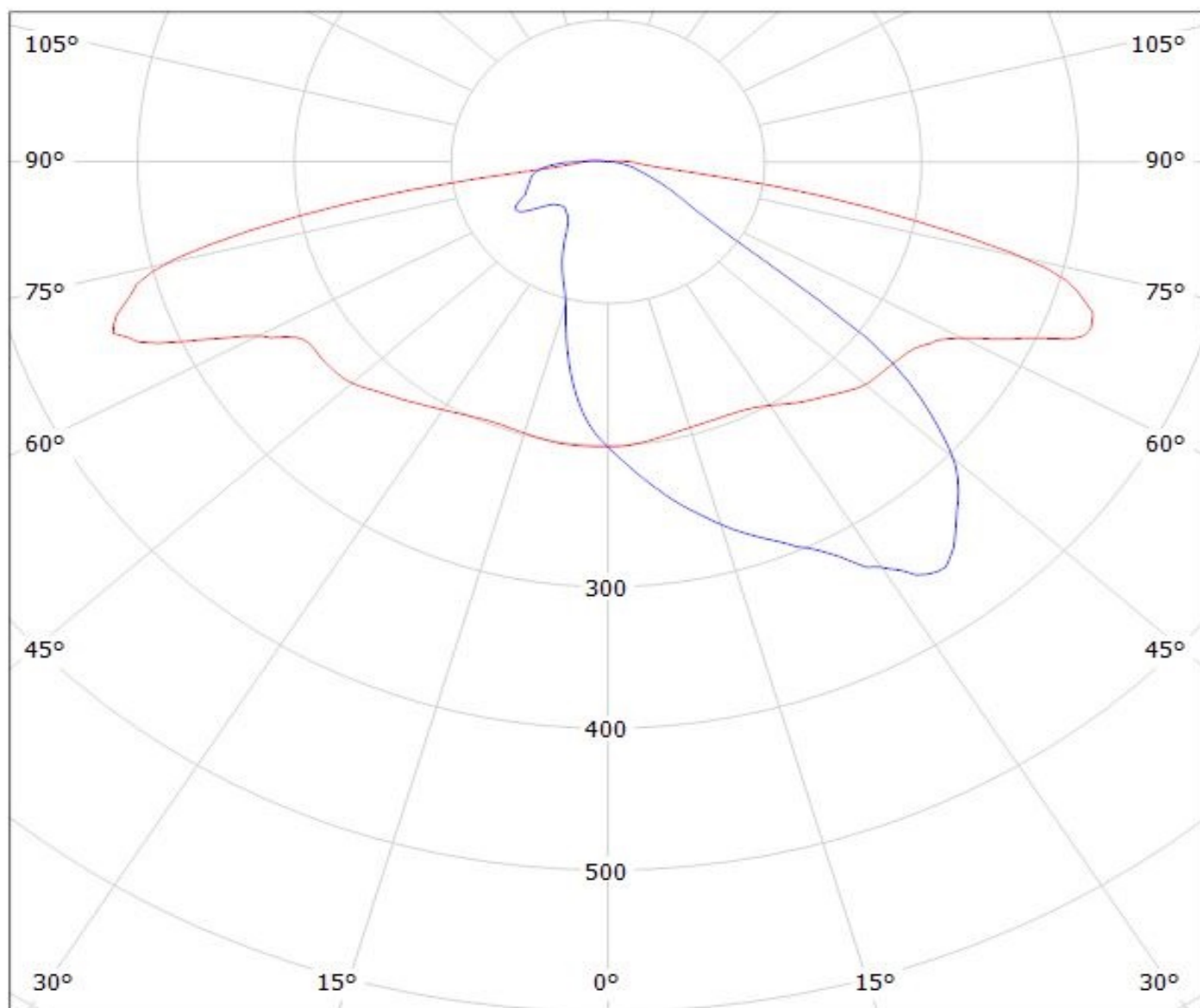

cd/klm

— C0 - C180 — C90 - C270

$\eta = 94\%$

Luminaire: Ledil C13299_STRADA-2X2-ME_(NVSW319AE)
Lamps: 1 x Nichia_NVSW319AE_(sm405D440f2L2R70)

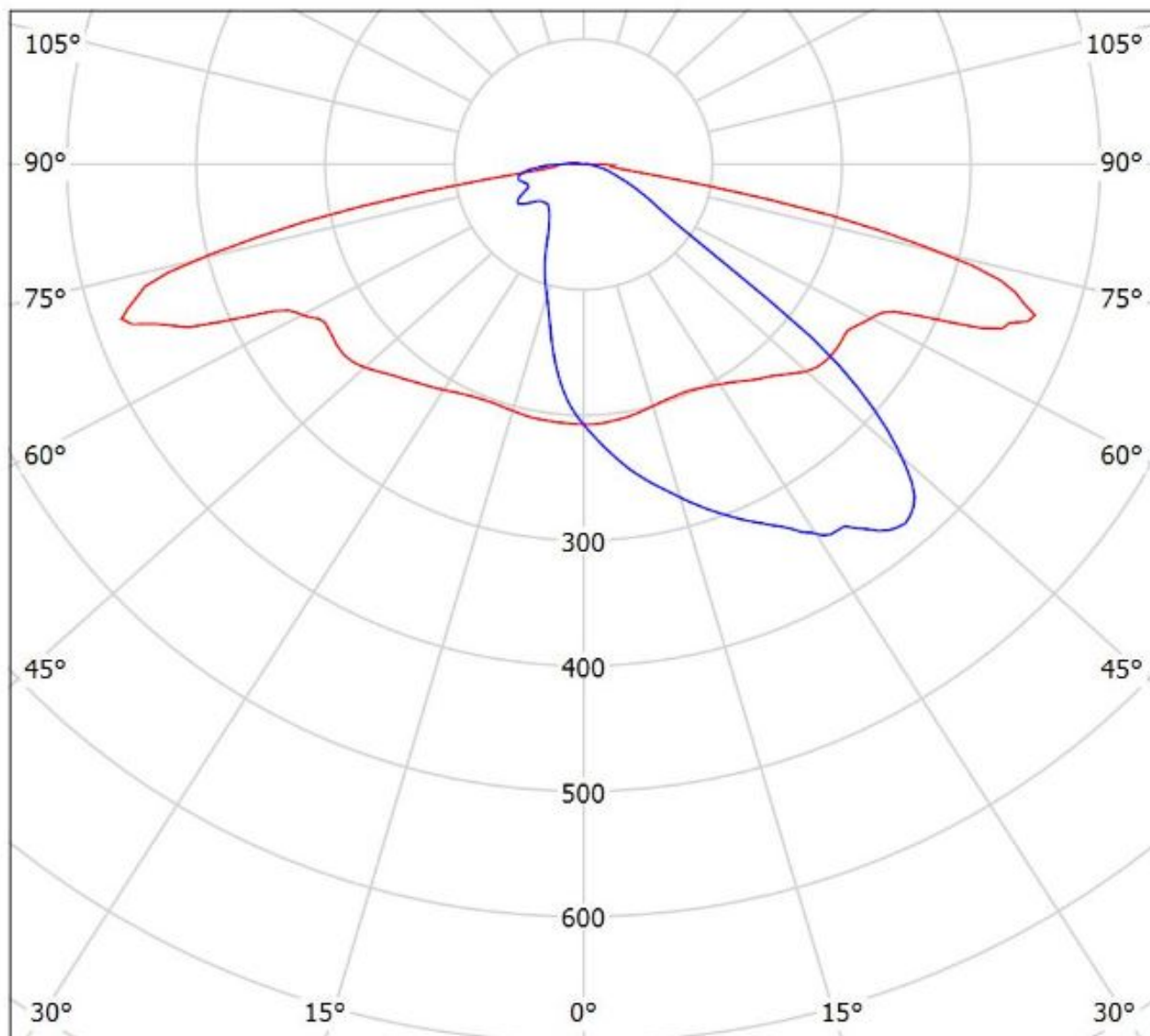

cd/klm
— C0 - C180 — C90 - C270

$\eta = 97\%$

LEDiL Oy C13299_STRADA-2X2-ME_(SQ-PC) Eff.94.0% / LDC (Polar)

Luminaire: LEDiL Oy C13299_STRADA-2X2-ME_(SQ-PC) Eff.94.0%

Lamps: 1 x SQ-PC_2x2_(LCW-CQAR.PC-MSMU-5H71-1)_400.75lm@250mA_CCT=?

K_P=2.96681W_l=249.9mA

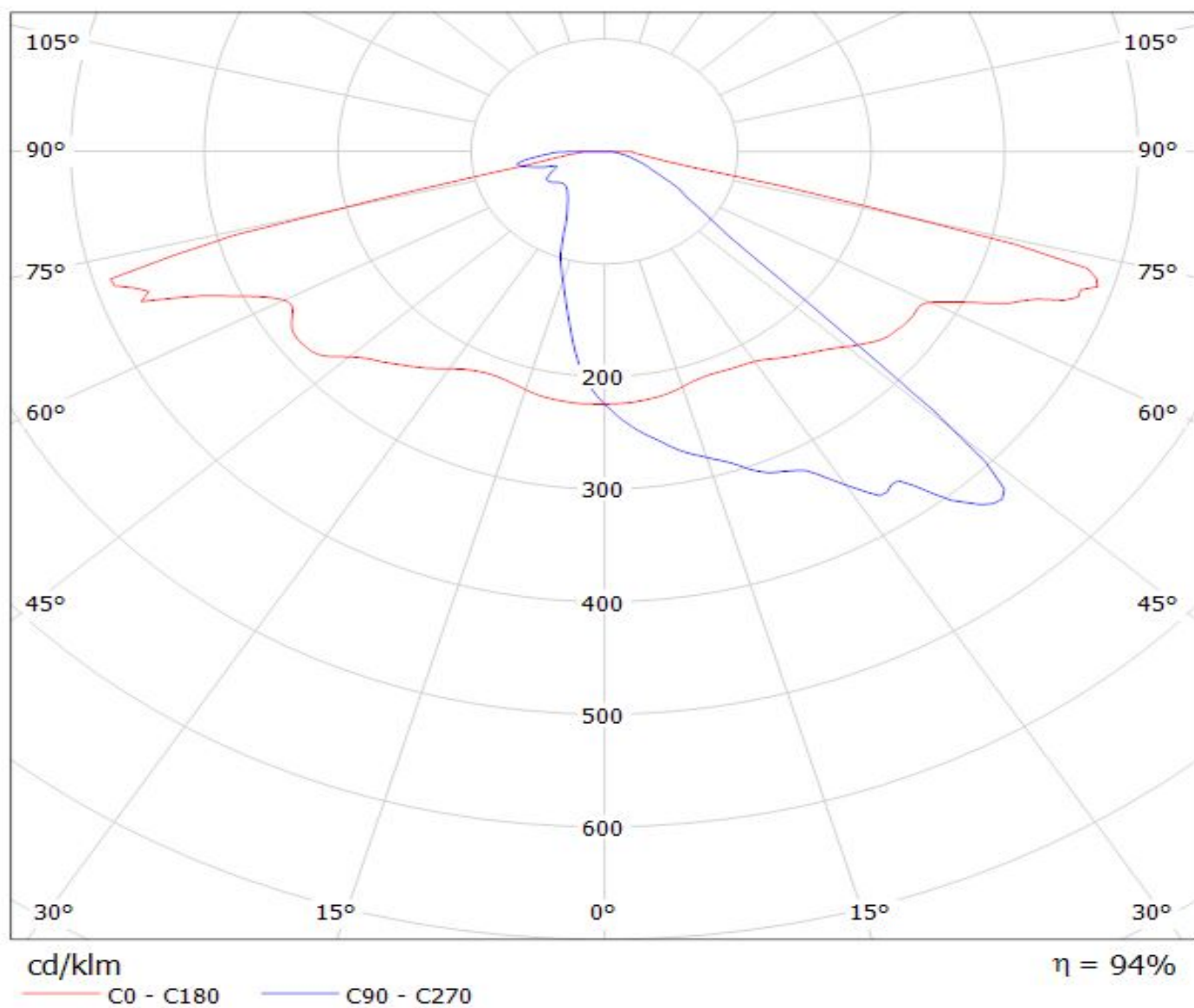

Luminaire: LEDiL Oy C13299_STRADA-2X2-ME_(Square_Gen3)

Lamps: 1 x Osram_Square_Gen3_GW_CSSRM2.PM_451.664lm@250mA_P=2.787_I=250mA

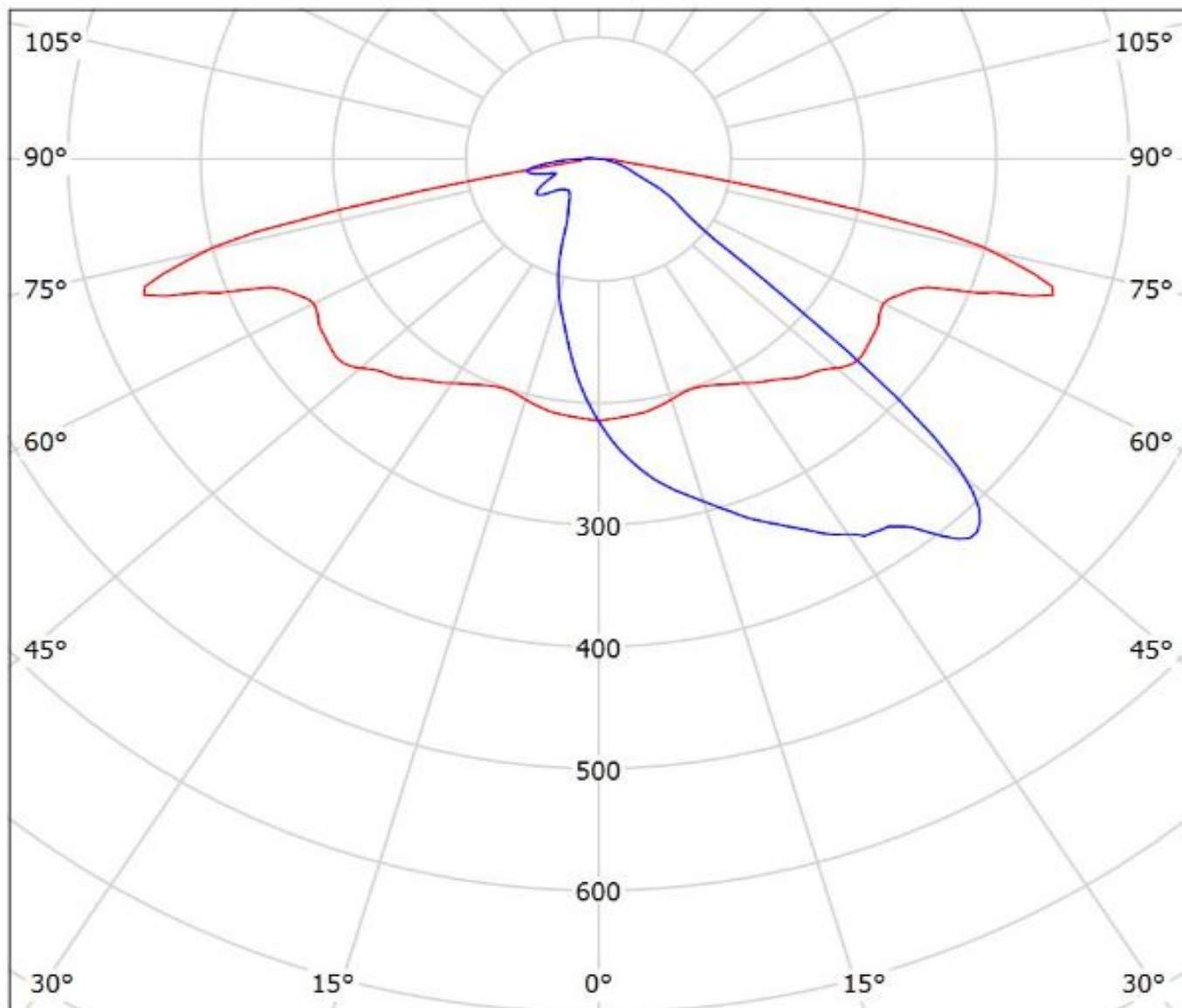

cd/klm

— C0 - C180 — C90 - C270

$\eta = 93\%$

Luminaire: Ledil Oy C13299_STRADA-2X2-ME_(Duris_P8)_SIMULATED
Lamps: 1 x Osram Duris P8

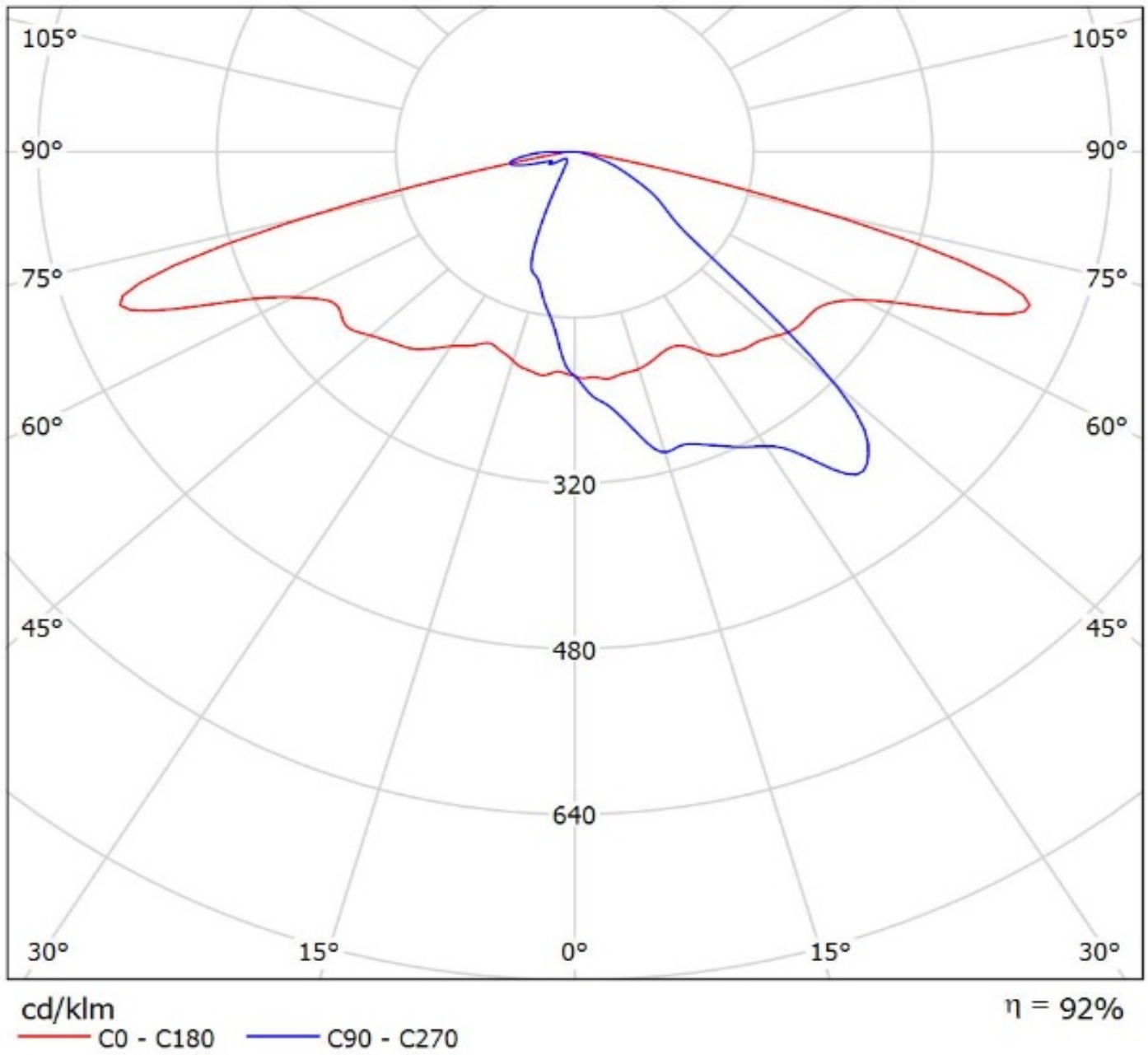

Luminaire: LEDiL Oy C13299_STRADA-2X2-ME_(Fortimo_F-Flex_2x8_740DAG3)
Lamps: 1 x Philips_Fortimo_F-Flex_2x8_740DAG3_1786.86lm@250mA_P=11.6092W_I=0.2498A

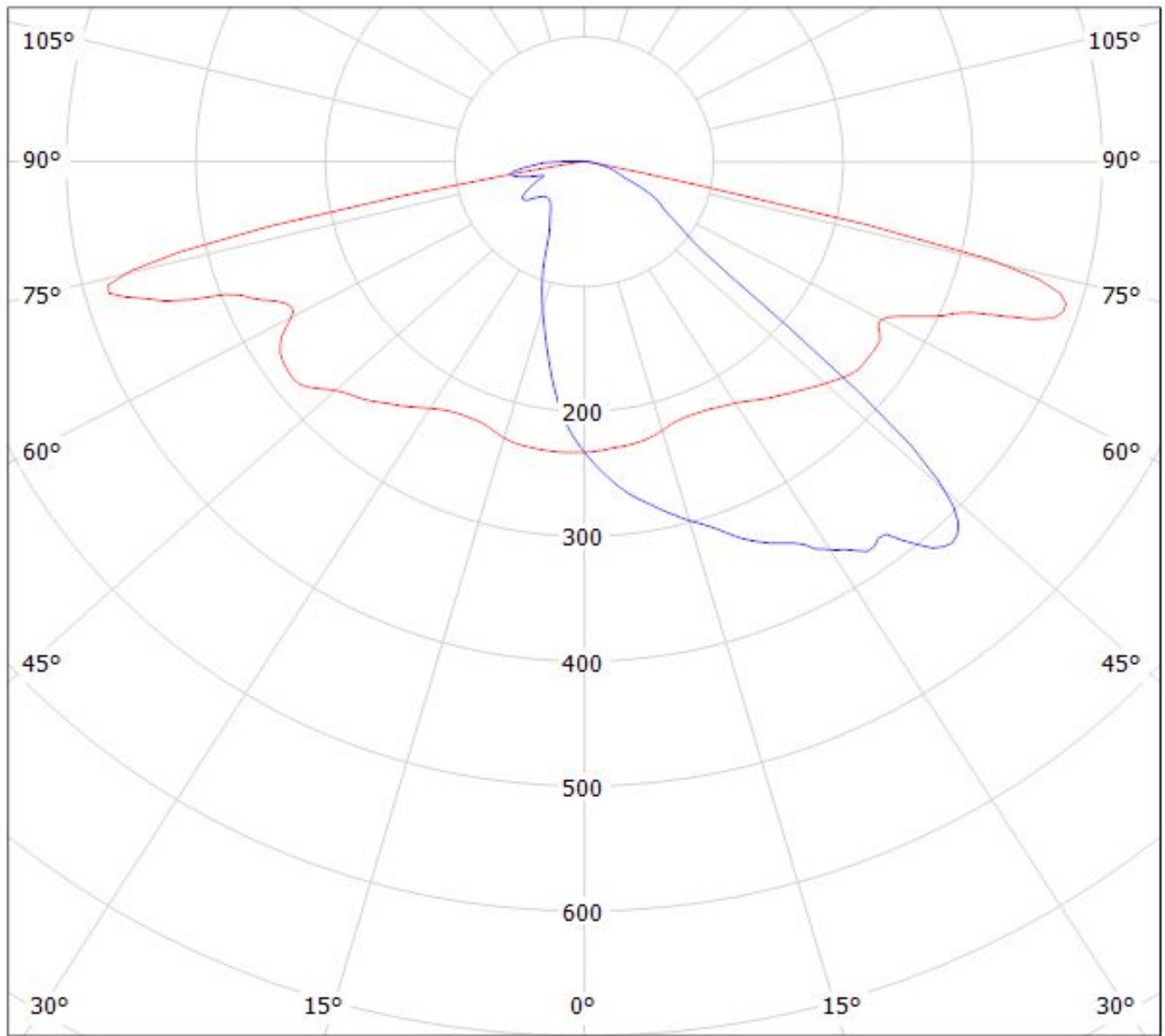

$\eta = 96\%$

cd/klm
— C0 - C180 — C90 - C270

Luminaire: LEDiL Oy C13299_STRADA-2X2-ME_(LH351B)

Lamps: 1 x SAMSUNG_LH351B_2x2_442.45lm@250mA_P=2.84311W_I=249.9mA

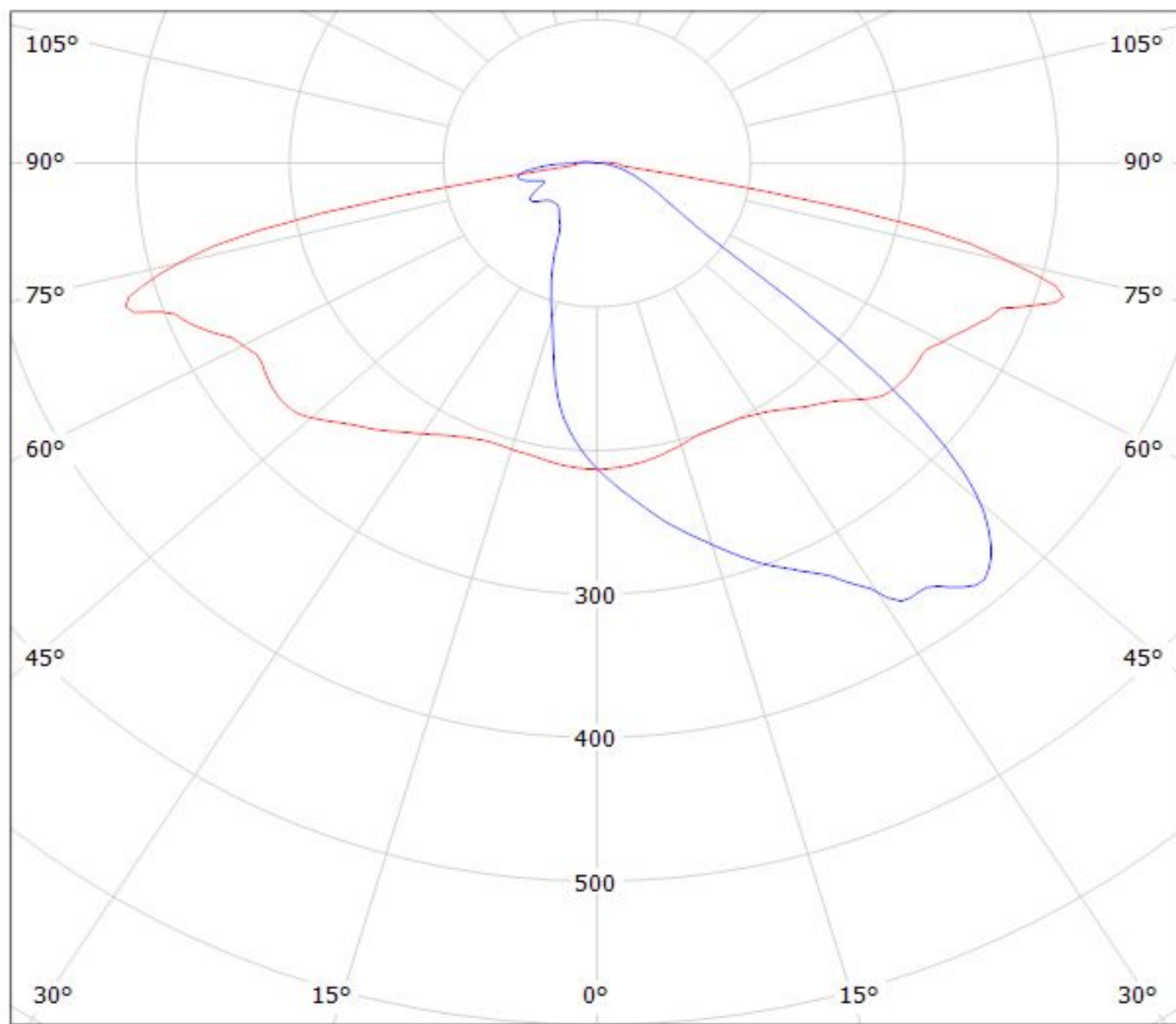

cd/klm

— C0 - C180

— C90 - C270

$\eta = 94\%$

Luminaire: LEDiL Oy C13299_STRADA-2X2-ME_(LH351D)
Lamps: 1 x Samsung_LH351D_524.264lm@250mA_P=2.7523W_I=0.250A

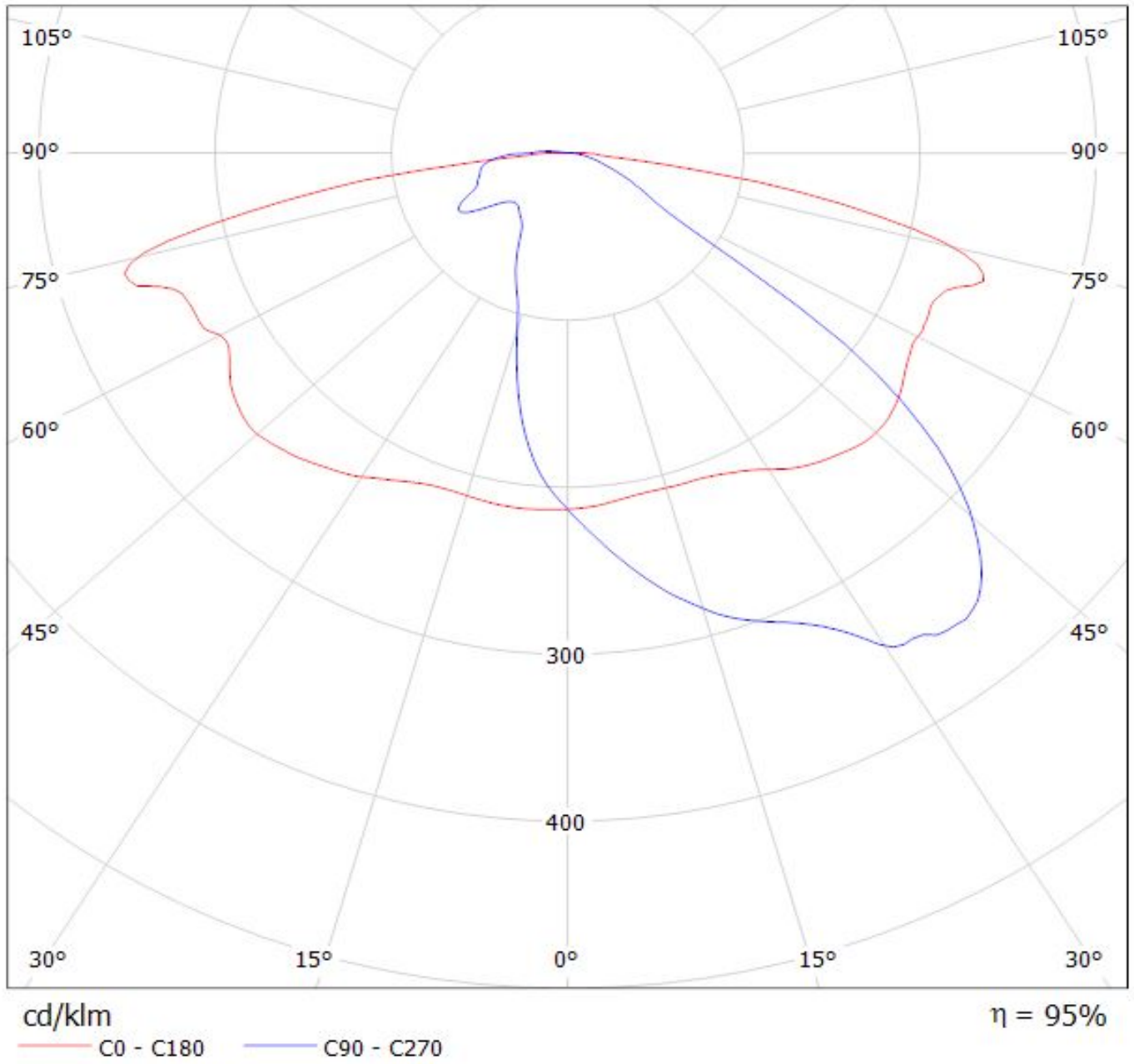

Luminaire: Ledil C13299_STRADA-2X2-ME_(LH351C)

Lamps: 1 x Samsung_LH351C_518.223lm@250mA_P=2.85225W_I=0.25A

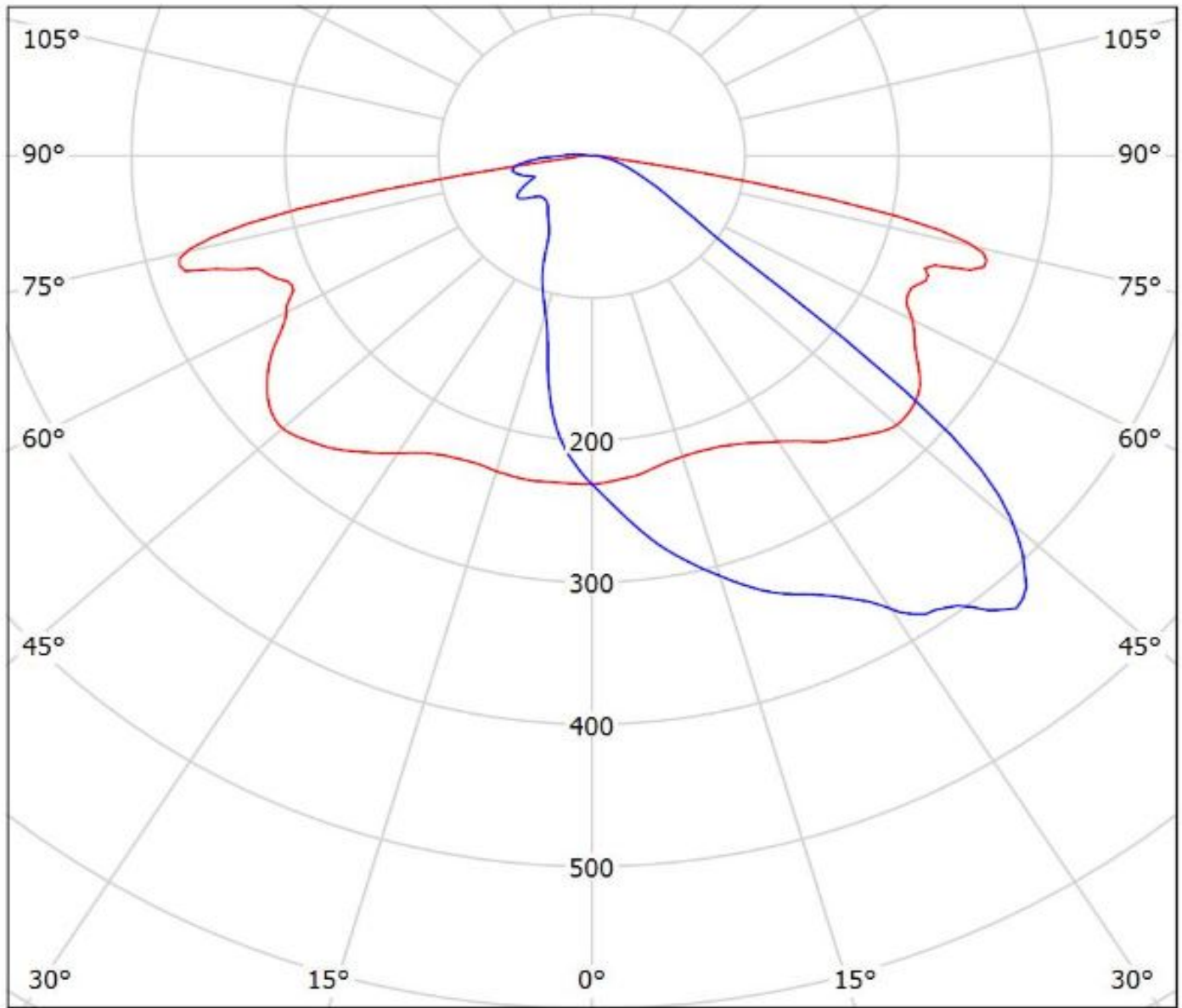

cd/klm

— C0 - C180 — C90 - C270

$\eta = 98\%$

Luminaire: Ledil C13299_STRADA-2X2-ME_(LH508A)

Lamps: 1 x Samsung_LH508A_2x2_2060.04lm@160mA_CCT=5000K_CRI=80_P=15.5405W_I=0.16A

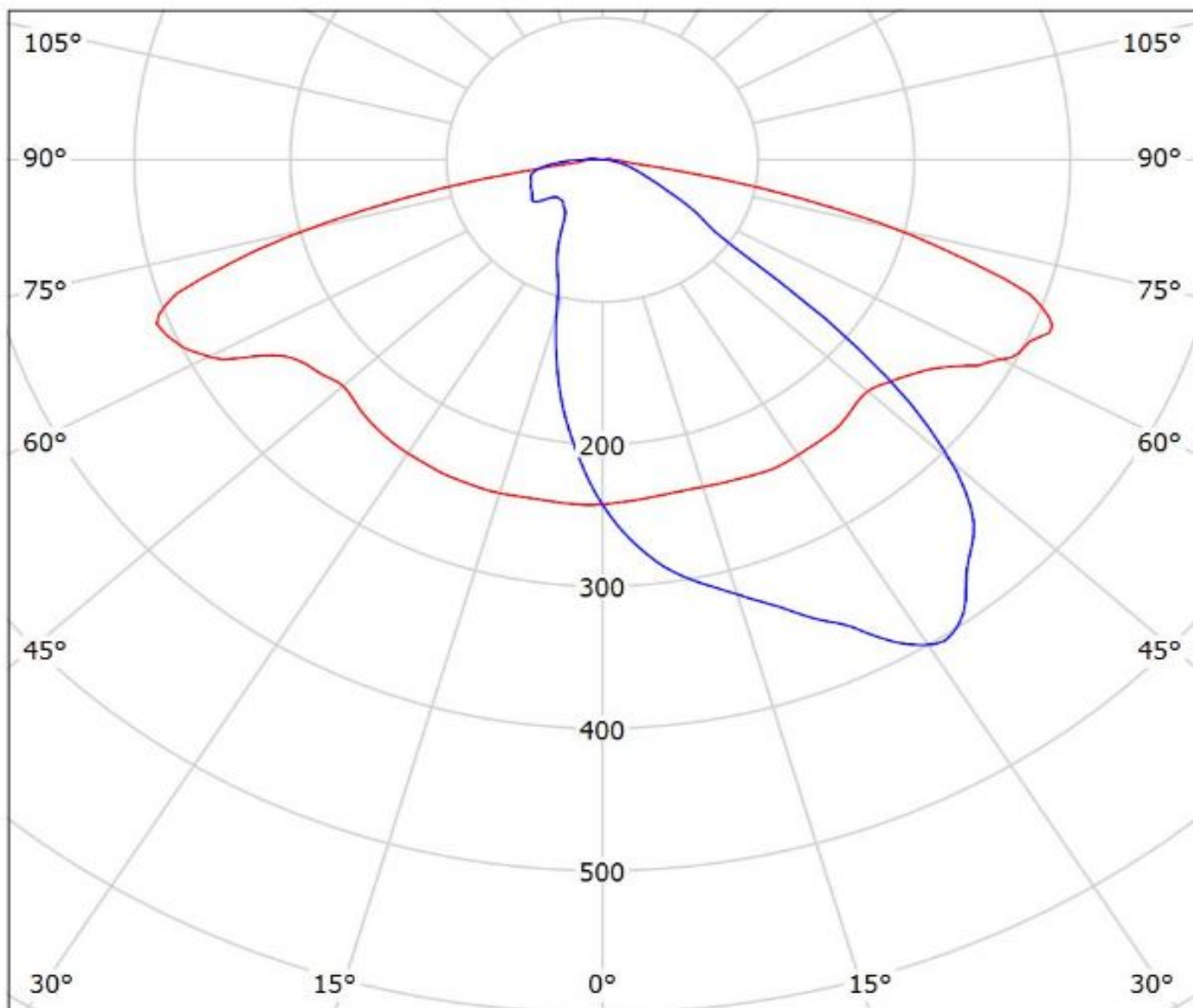

cd/klm

— C0 - C180 — C90 - C270

$\eta = 98\%$

LEDiL Oy C13299_STRADA-2X2-ME_(Z5P) Eff.94.0% / LDC (Polar)

Luminaire: LEDiL Oy C13299_STRADA-2X2-ME_(Z5P) Eff.94.0%

Lamps: 1 x Seoul_Z5P_2x2_290.05lm@250mA_P=3.6208W_I=249.9mA

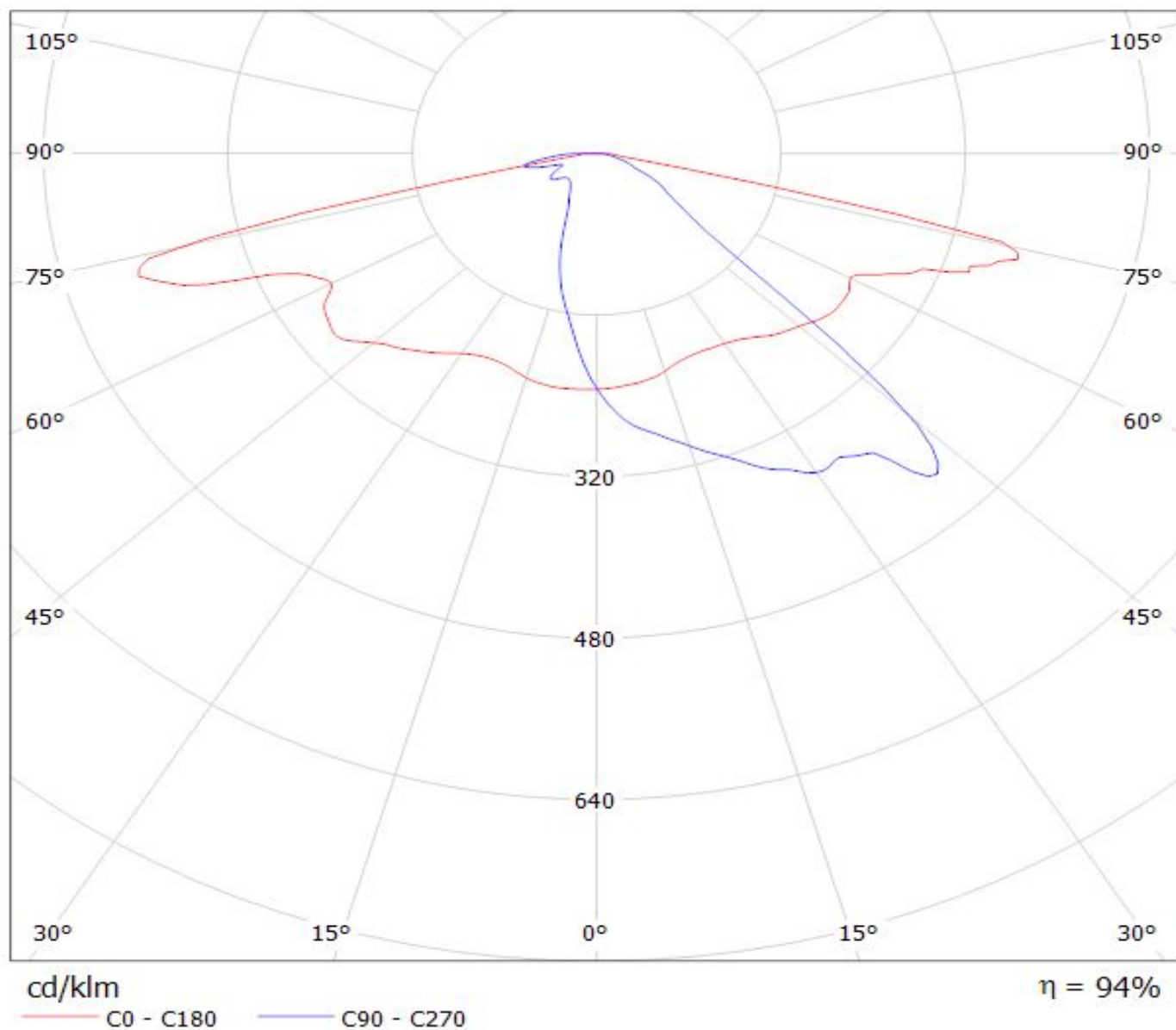

Luminaire: LEDiL Oy C13299_STRADA-2x2-ME_(MJT4040) Eff. 94%

Lamps: 1 x SEOUL ACHRICH MJT4040 (SAW09H0A) 255lm@40mA P=2.37W I=40mA

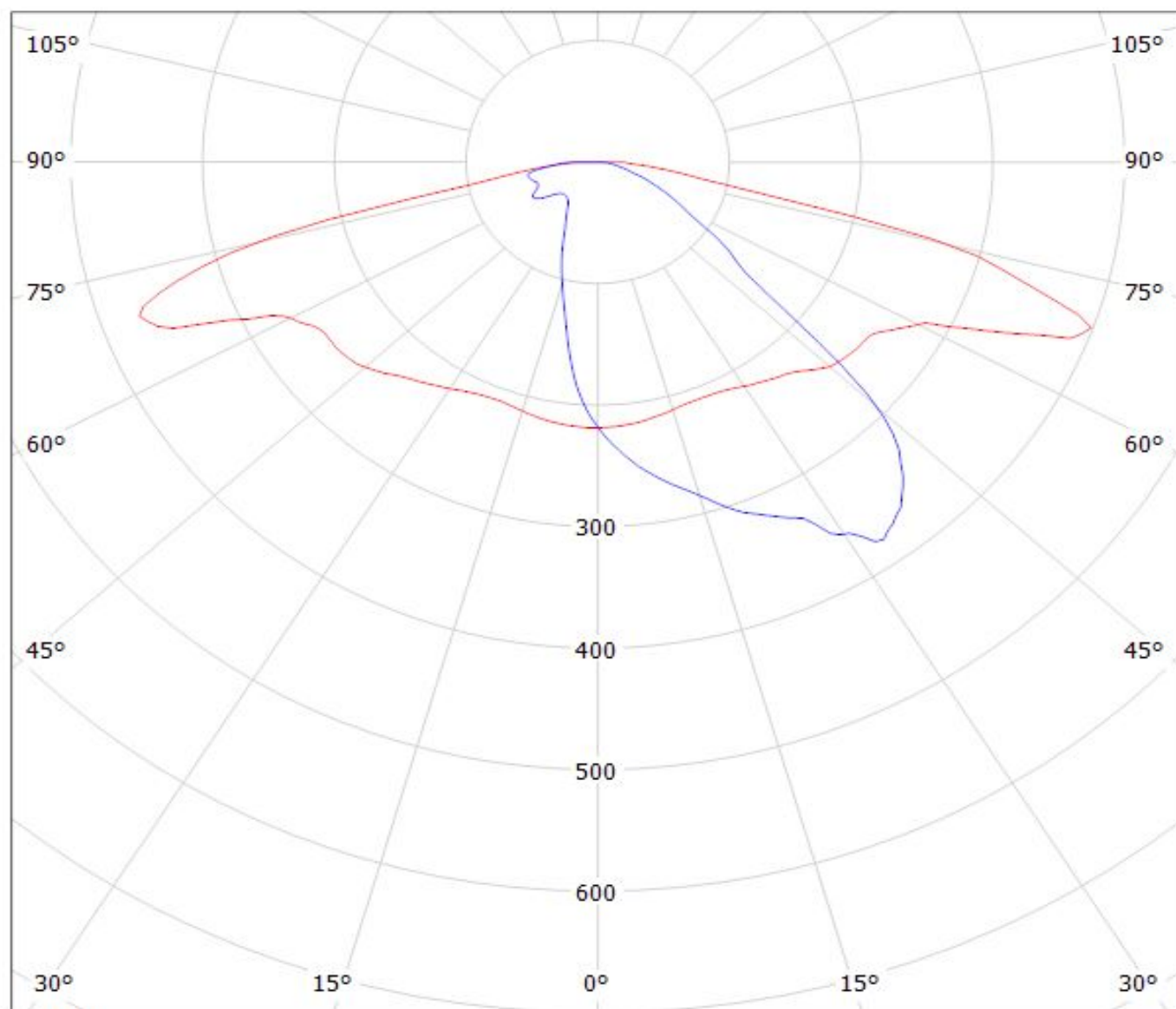

cd/klm

— C0 - C180

— C90 - C270

$\eta = 95\%$

LEDiL Oy C13299_STRADA-2X2-ME_(Z5M) Eff.94.0% / LDC (Polar)

Luminaire: LEDiL Oy C13299_STRADA-2X2-ME_(Z5M) Eff.94.0%

Lamps: 1 x SEOUL_Z5M_(SZ5-M0-W0-00)_364.5lm@250mA_P=2.95788W_I=249.8mA

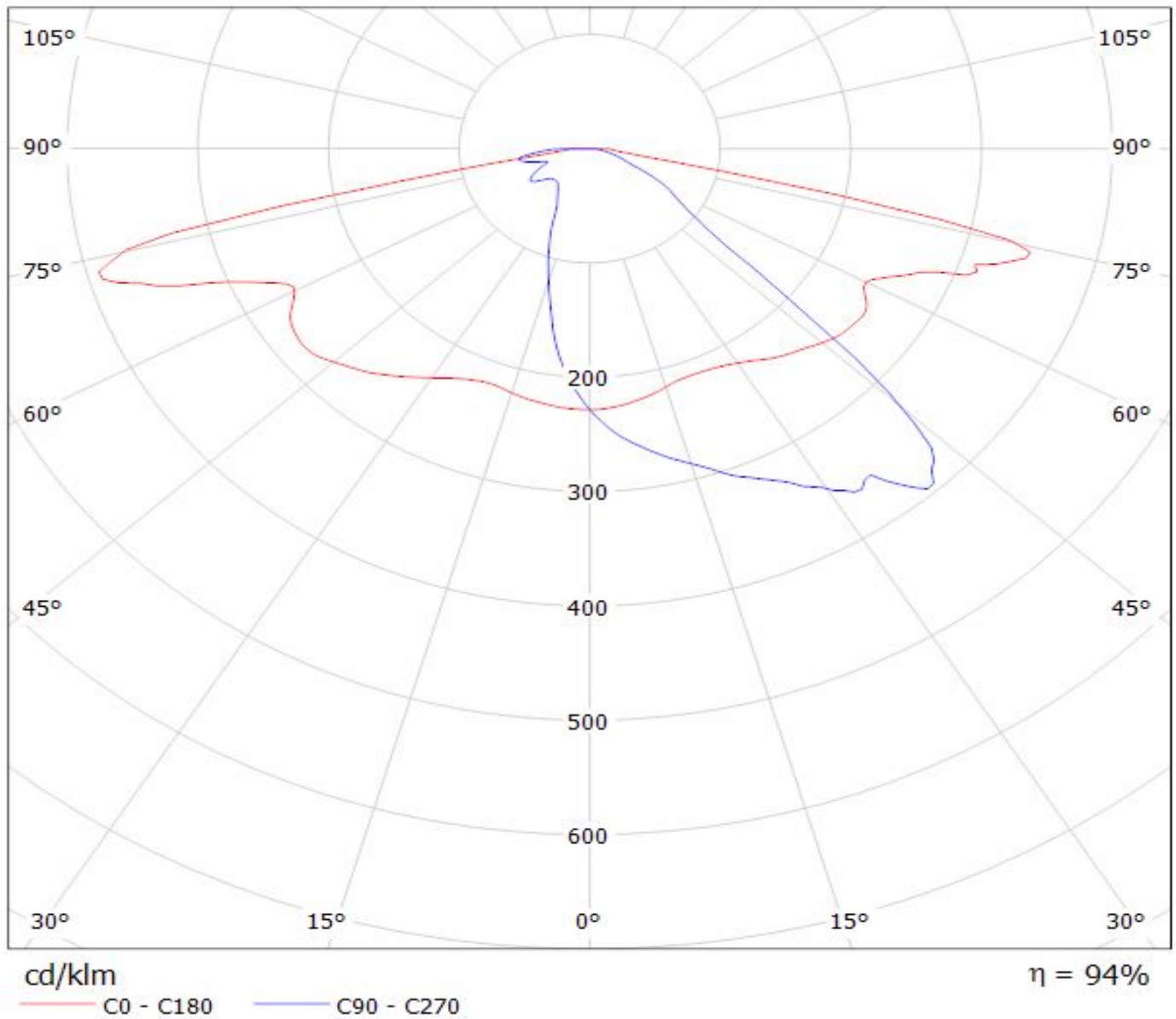

Luminaire: LEDil Oy C13299_STRADA-2X2-ME_(Z5M1) Efficiency=94%
Lamps: 1 x Seoul Z5M1 (SZ5-M1-WN-C8) 379lm @ 250mA CCT=4600K P=2.9W I=250mA

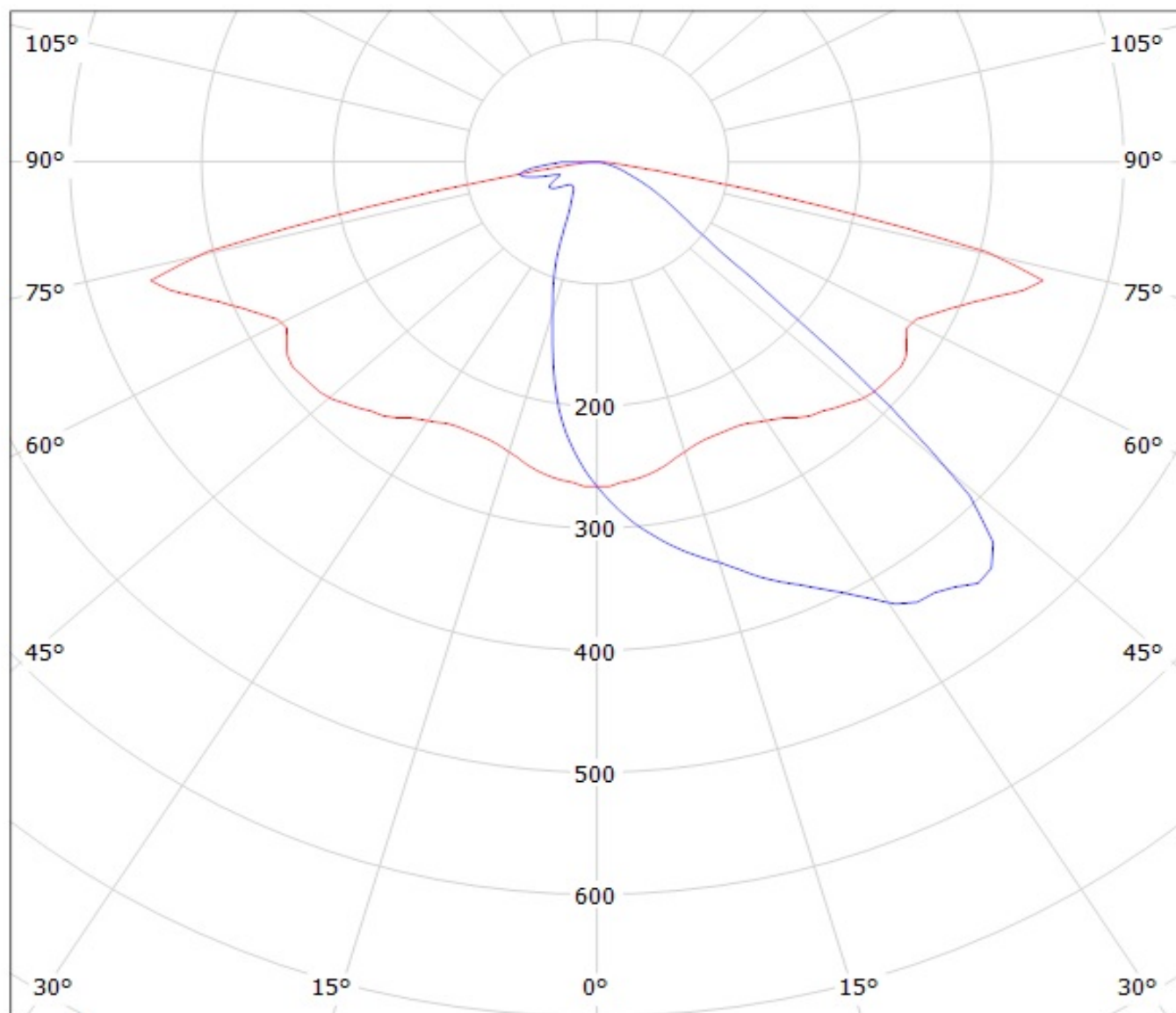

cd/klm

— C0 - C180 — C90 - C270

Luminaire: Ledil C13299_STRADA-2X2-ME_(Z8Y22plus)

Lamps: 1 x Seoul_Z8Y22plus_(W6E2G)_513.996lm@250mA_P=2.754W_I=0.250A

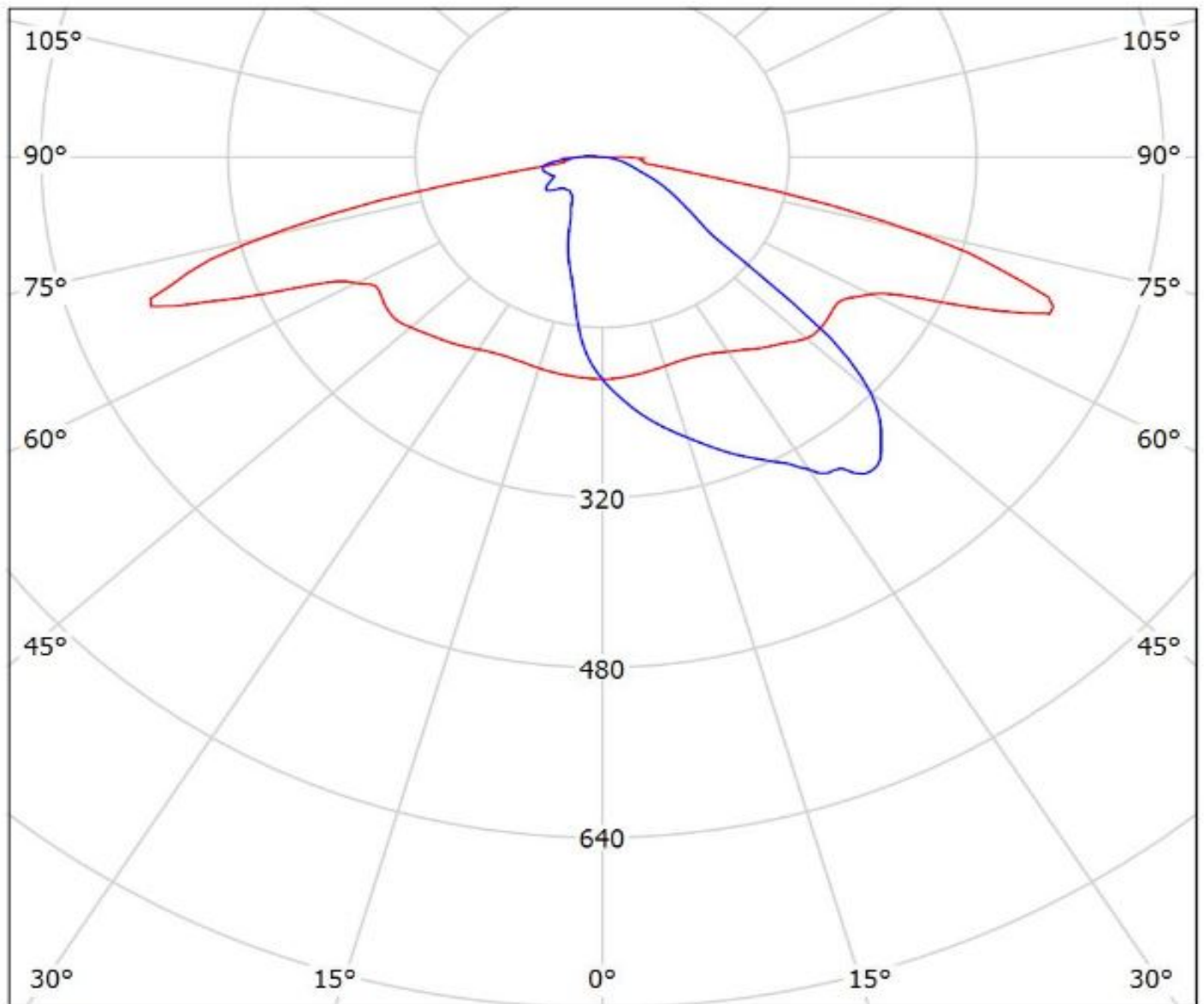

cd/klm

— C0 - C180 — C90 - C270

$\eta = 97\%$

Ledil C13299_STRADA-2X2-ME_(TL1L3) / LDC (Polar)

Luminaire: Ledil C13299_STRADA-2X2-ME_(TL1L3)

Lamps: 1 x Toshiba_TL1L3_2x2_(TL1L3-NW1.L)_387.773lm@250mA_CCT=5000K_P=2.829W_I=0.25A

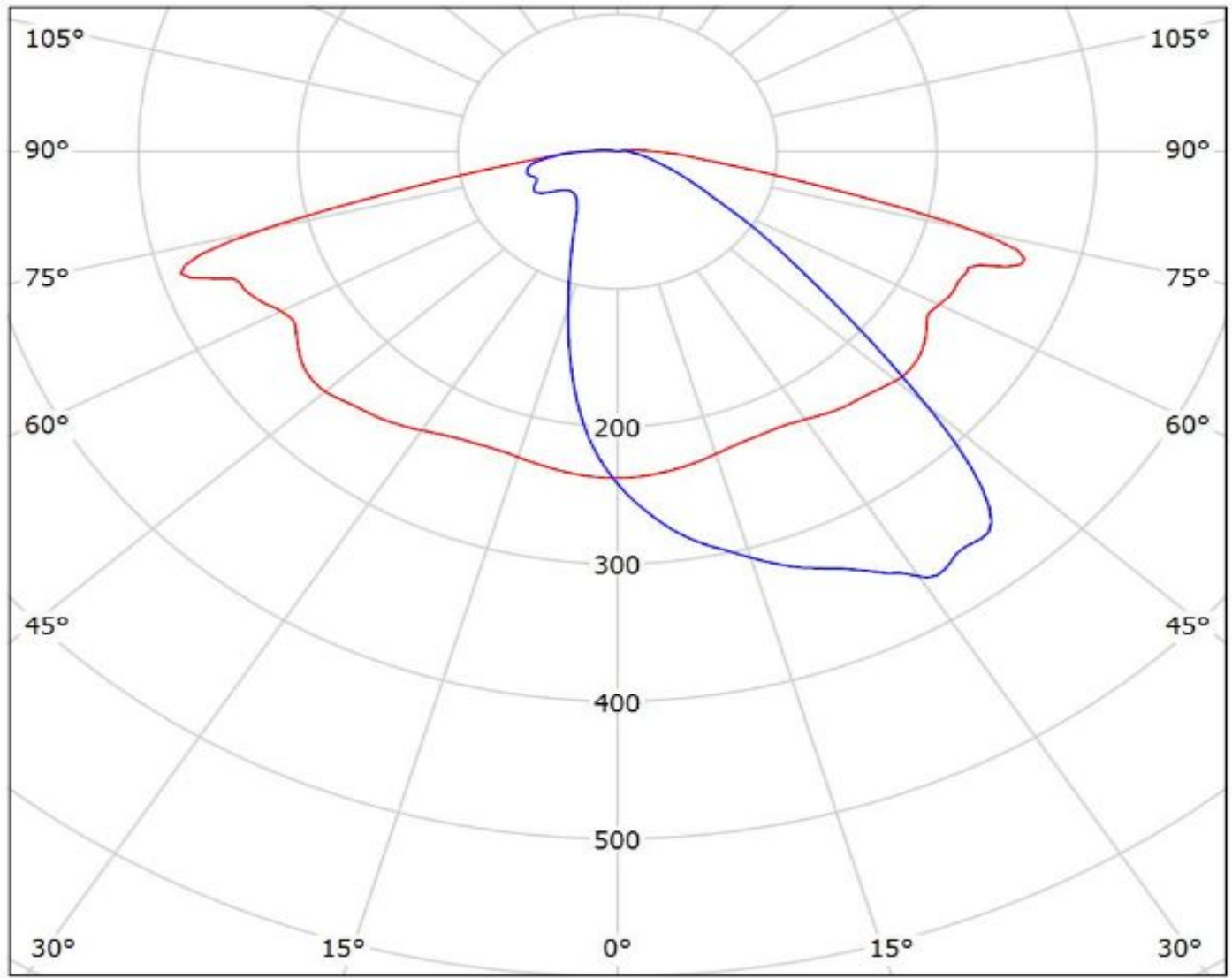

cd/klm

— C0 - C180

— C90 - C270

$\eta = 96\%$

Ledil C13299_STRADA-2X2-ME_(TL1L4) / LDC (Polar)

Luminaire: Ledil C13299_STRADA-2X2-ME_(TL1L4)

Lamps: 1 x Toshiba_TL1L4_2x2_(TL1L4-DW0)_472.639lm@250mA_CCT=6500K_P=2.9W_I=0.25A

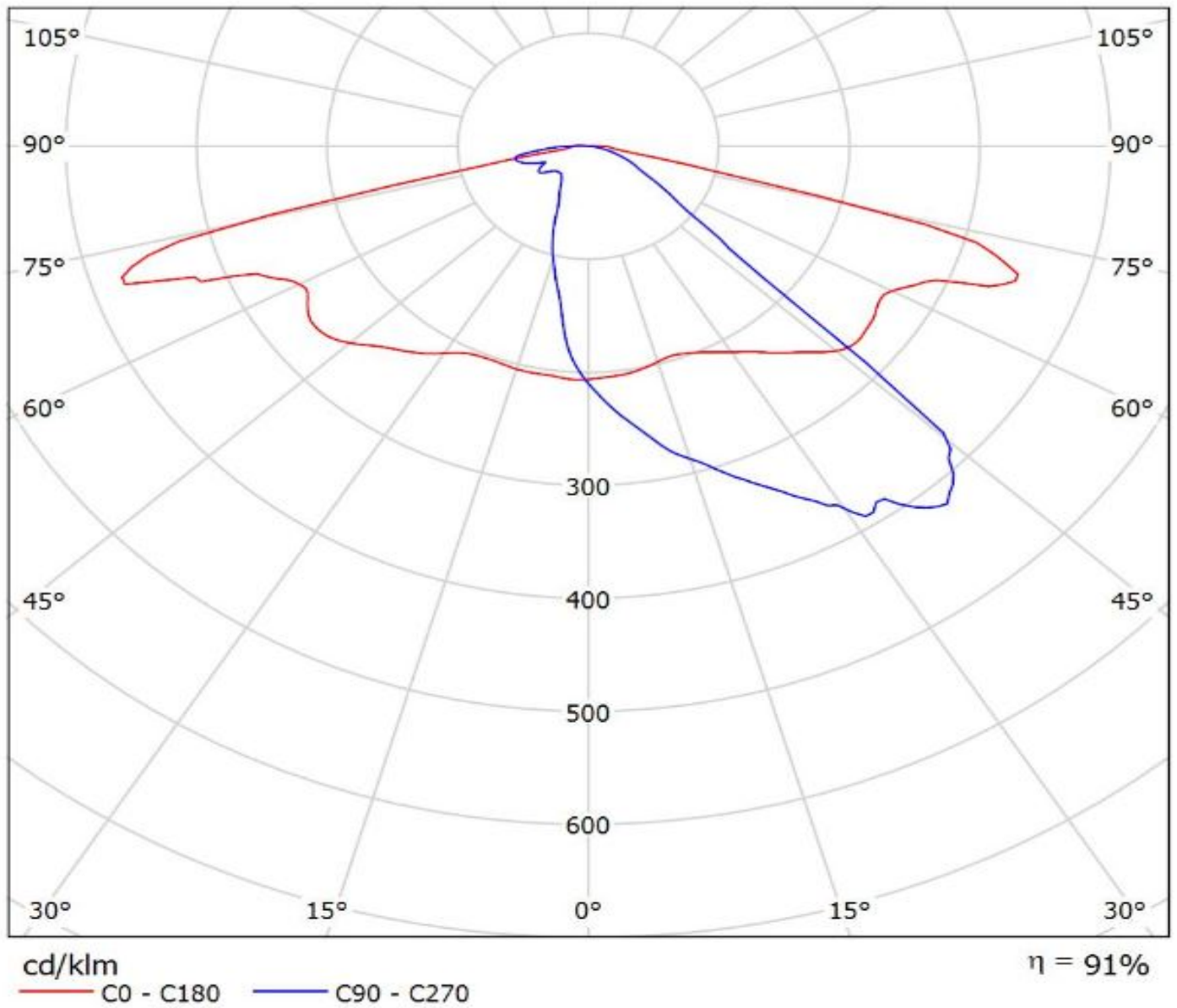

Luminaire: LEDiL Oy C13299_STRADA-2X2-ME_(Tridonic_Module_RLE_G1)
Lamps: 1 x Tridonic_Module_RLE_G1_4576.03lm@700mA_P=32.0681W_I=0.700A

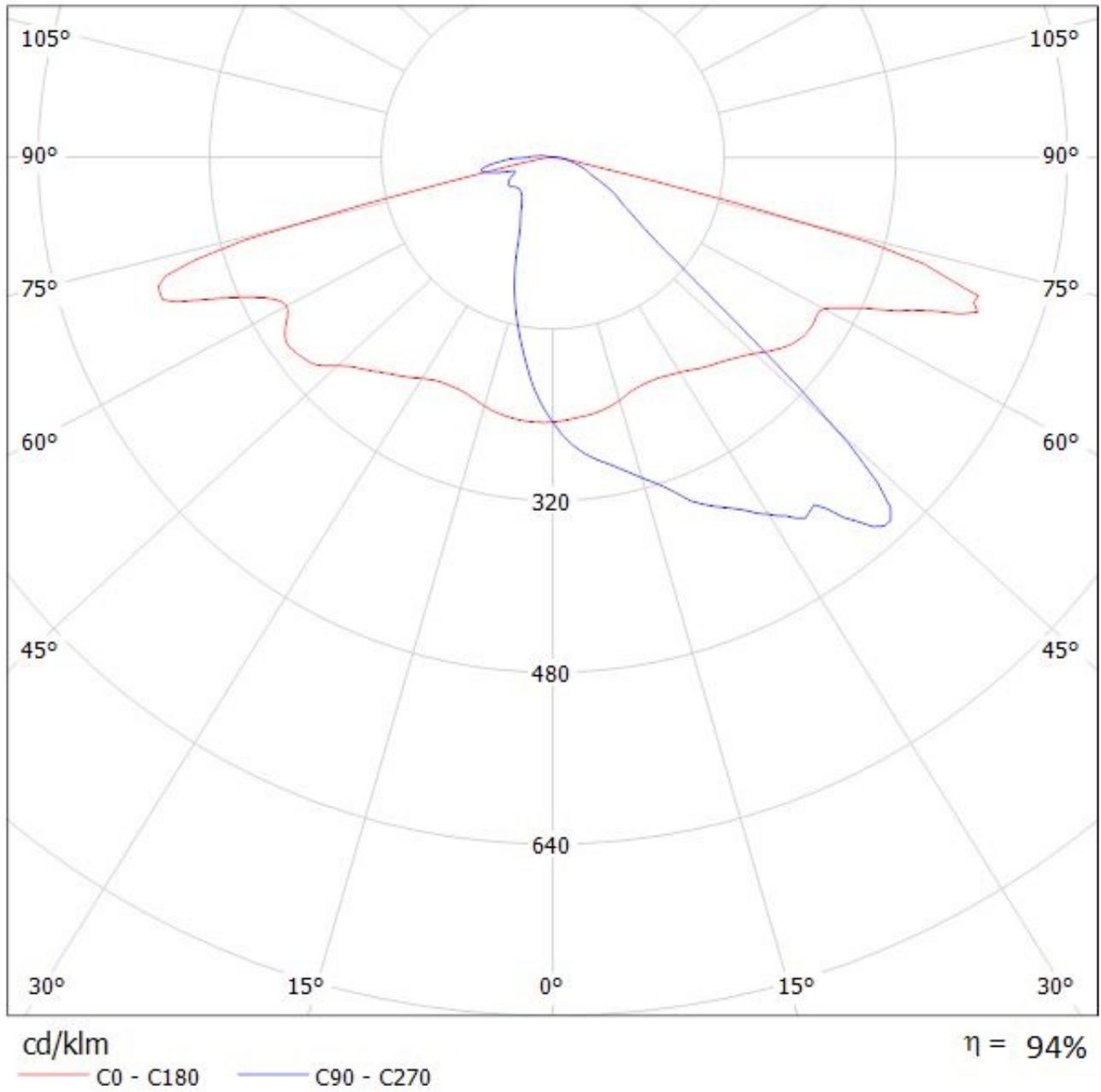

Luminaire: LEDiL Oy C13299_STRADA-2X2-ME_(Tridonic_Module_RLE_G1)
Lamps: 1 x Tridonic_Module_RLE_G1_4576.03lm@700mA_P=32.0681W_I=0.700A

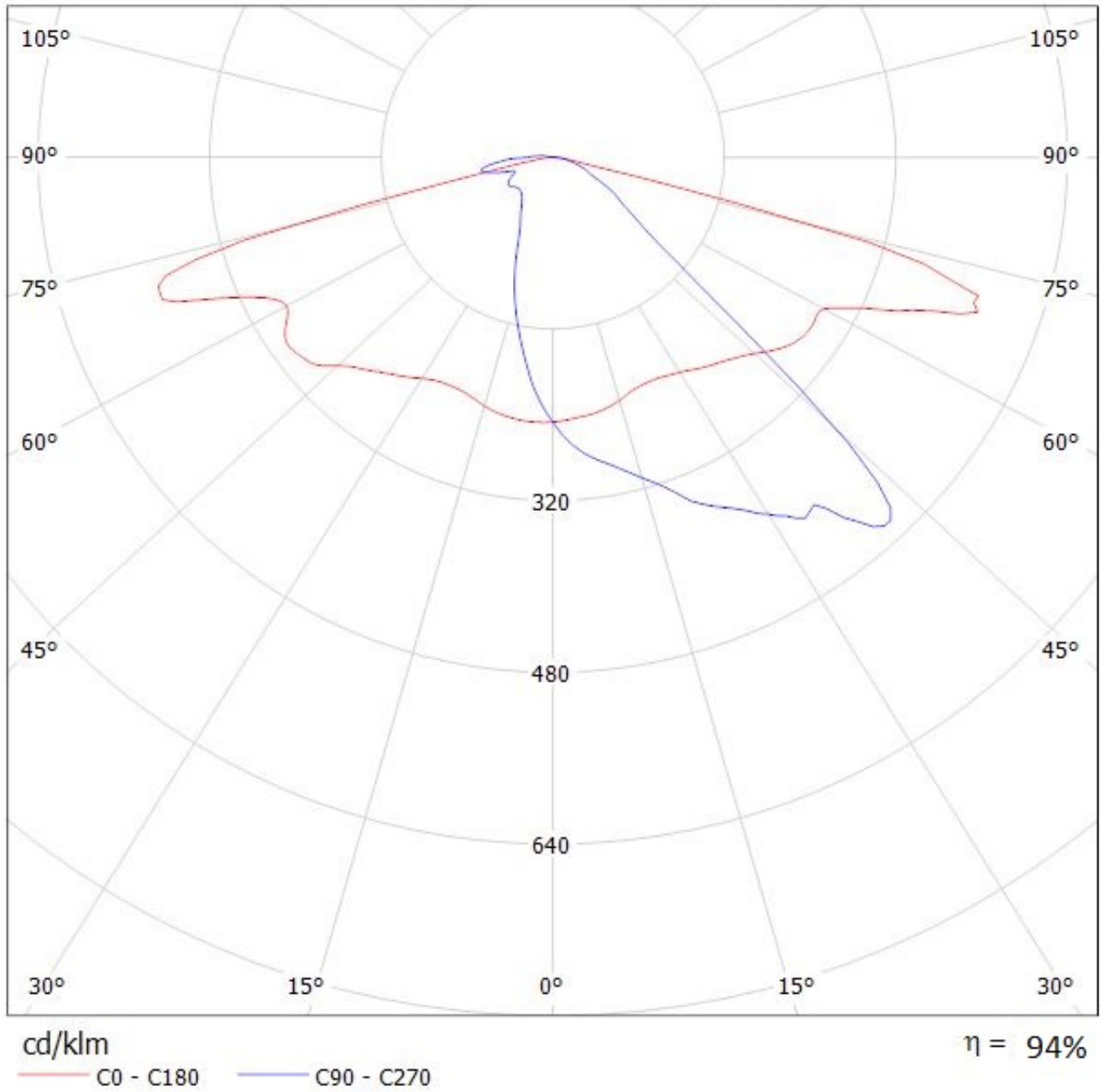

Luminaire: LEDiL Oy C13299_STRADA-2X2-ME_(Tridonic_Module_RLE_G1)
Lamps: 1 x Tridonic_Module_RLE_G1_2288lm@700mA_P=16W_I=0.700A

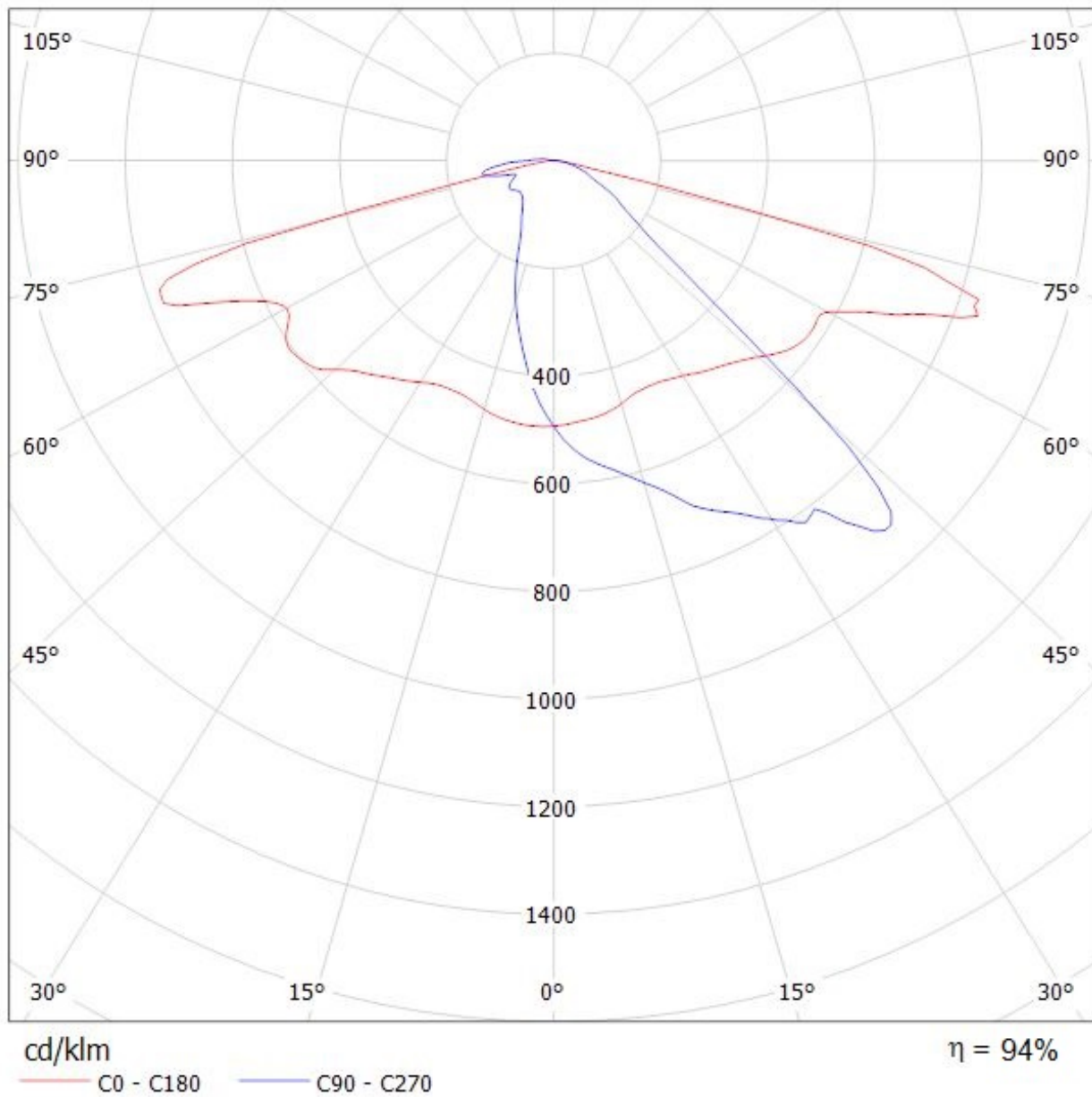

Luminaire: LEDiL Oy C13299_STRADA-2X2-ME_(Tridonic_Module_RLE_G1)
Lamps: 1 x Tridonic_Module_RLE_G1_2288lm@700mA_P=16W_I=0.700A

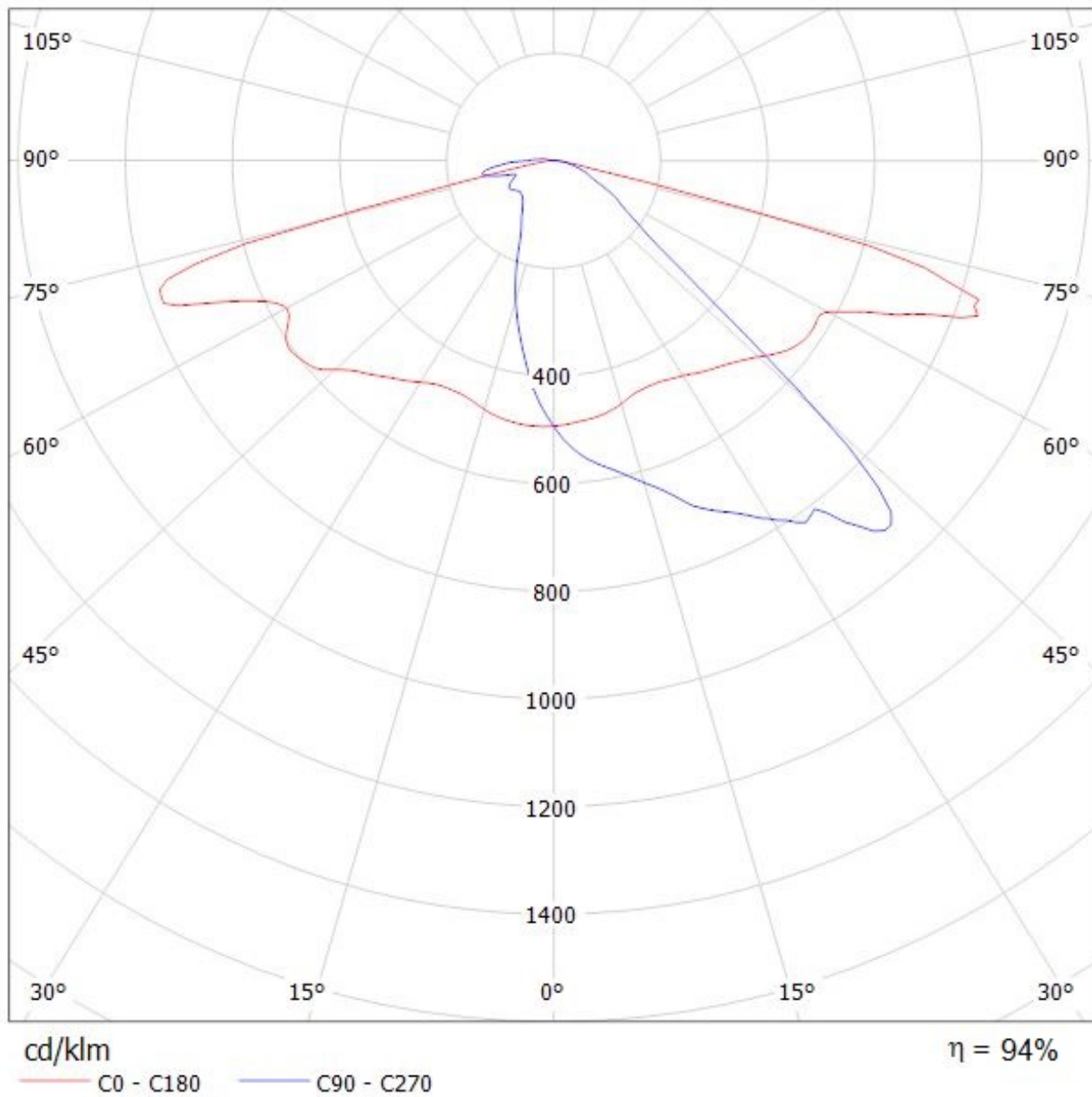

NOTE: The typical divergence will be changed by different color, chip size and chip position tolerance. The typical total divergence is the full angle measured where the luminous intensity is half of the peak value.