

## DETAILS

<b>Product Number</b>	C13528_VERONICA-RS
<b>Family</b>	Veronica
<b>Type</b>	Lens
<b>Color</b>	clear
<b>Diameter</b>	26 mm
<b>Height</b>	12,2 mm
<b>Style</b>	round
<b>Optic Material</b>	PMMA
<b>Holder Material</b>	
<b>Fastening</b>	pin, glue
<b>Status</b>	production ready
<b>ROHS Compliant</b>	Yes
<b>Date Updated</b>	28/10/2013



## OPTICAL PROPERTIES

LED	Viewing	Light	Efficiency	cd/lm	Connector
	Angle	Beam			
XP-G2	10 deg	Real spot	90 %	19.000	-
XP-G	12 deg	Real spot	90 %	18.400	-
XM-L2	16 deg	Real spot	90 %	8.500	-
XB-H	11 deg	Real spot	89 %	15.900	-
LUXEON A	13 deg	Real spot	89 %	14.700	-
LUXEON Rebel	12 deg	Real spot	88 %	14.900	-
NVSxx19B/NVSxx19C	13 deg	Real spot	87 %	12.200	-
NCSxx19A	13 deg	Real spot	86 %	15.000	-
NVSxx19A	14 deg	Real spot	85 %	10.000	-
NVSW3x9A	13 deg	Real spot	89 %	10.300	-
LH351Z	11 deg	Real spot	89 %	19.900	-
LH351B	sim: 12	Real spot	93 %	-	-
Z8Y22P	11 deg	Real spot	87 %	10.400	-

D

C

B

A

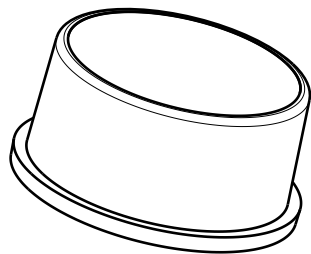

Isometric view

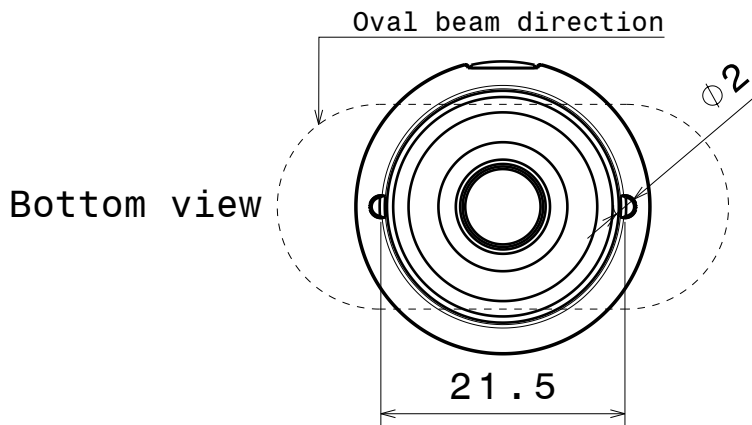

Bottom view

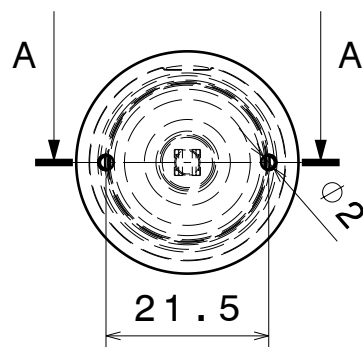

Front view

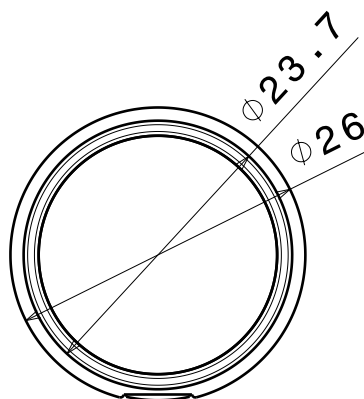
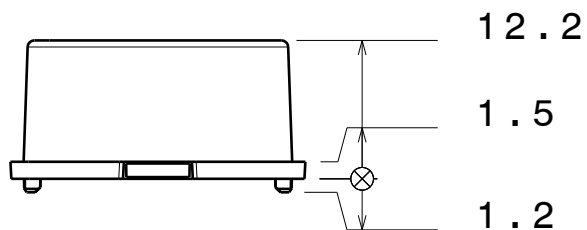

Top view

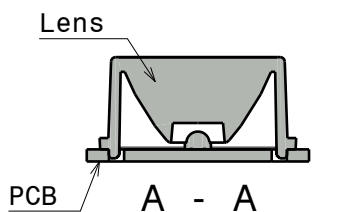

PCB suggestion

INDEX	PART NO	DESCRIPTION	MATERIAL	COLOUR
1	-	VERONICA	PMMA	

Tolerances if not otherwise shown  
 According to DIN ISO 2768-1  
 Linear measures:  
 Up to 30mm class M, otherwise class C.  
 According to DIN ISO 2768-2  
 Form and position: class L

**LEDiL** LediL Oy  
 Salorankatu 10  
 FIN 24240 SALO  
 Finland

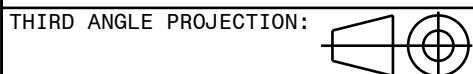

DRAWING TITLE  
**VERONICA SERIES**

This drawing is the property  
 of LEDiL Oy. It may not be  
 reproduced, copied or  
 communicated without a written  
 agreement with LEDiL Oy."

SIZE	PART NUMBER
A4	-

SCALE	1:1	WEIGHT	SHEET	1/1
-------	-----	--------	-------	-----

D

A

Luminaire: Ledil Oy C13528\_VERONICA-RS\_XP-G2\_Simulated\_100LM C13528\_VERONICA-RS\_XP-G2\_Simulated\_100LM  
Lamps: 1 x Cree XP-G2 100lm

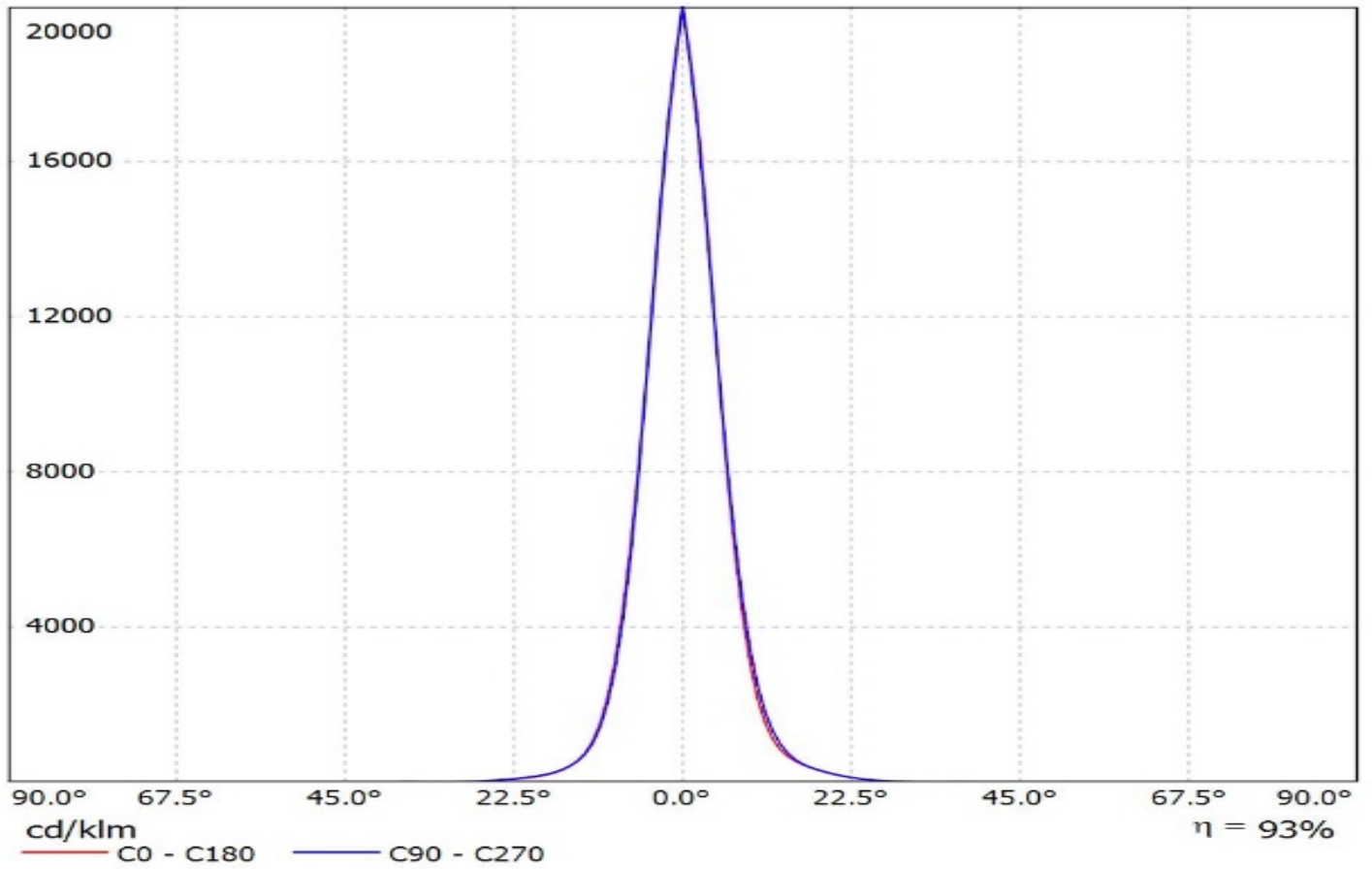

Luminaire: Ledil Oy C13528\_VERONICA-RS\_(XP-G) Efficiency=90%  
Lamps: 1 x Cree XP-G (XPGWHT-L1-GWPI-00BE7) 67lm @ 250mA CCT=3100K P=0.8W I=250mA

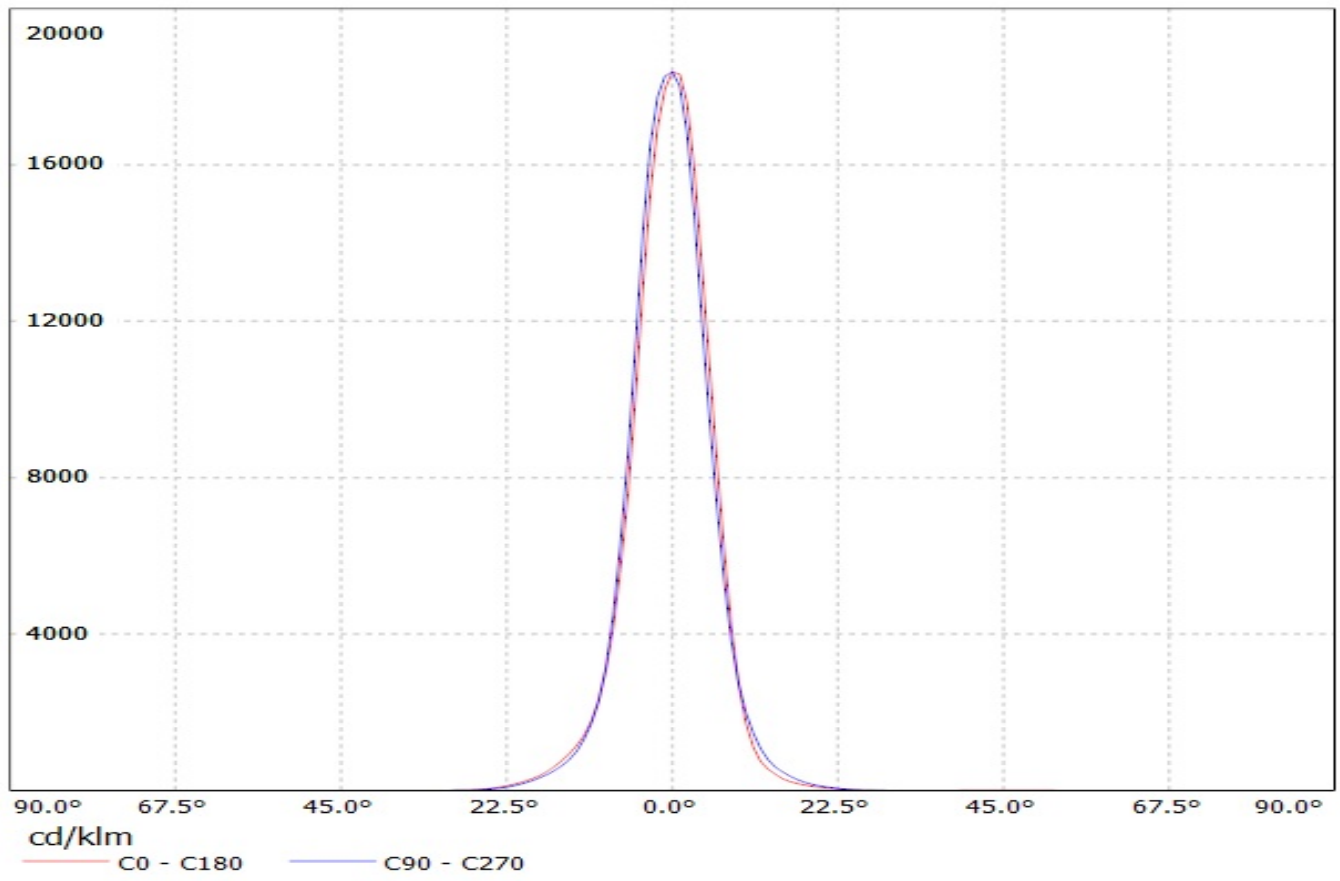

Luminaire: Ledil Oy C13528\_VERONICA-RS\_(XM-L2) Efficiency=90%  
Lamps: 1 x Cree Xm-L2 (XMLBWT-0-7B4-T30-0L-001) 91lm @ 250mA CCT=3200K P=0.7W I=250mA

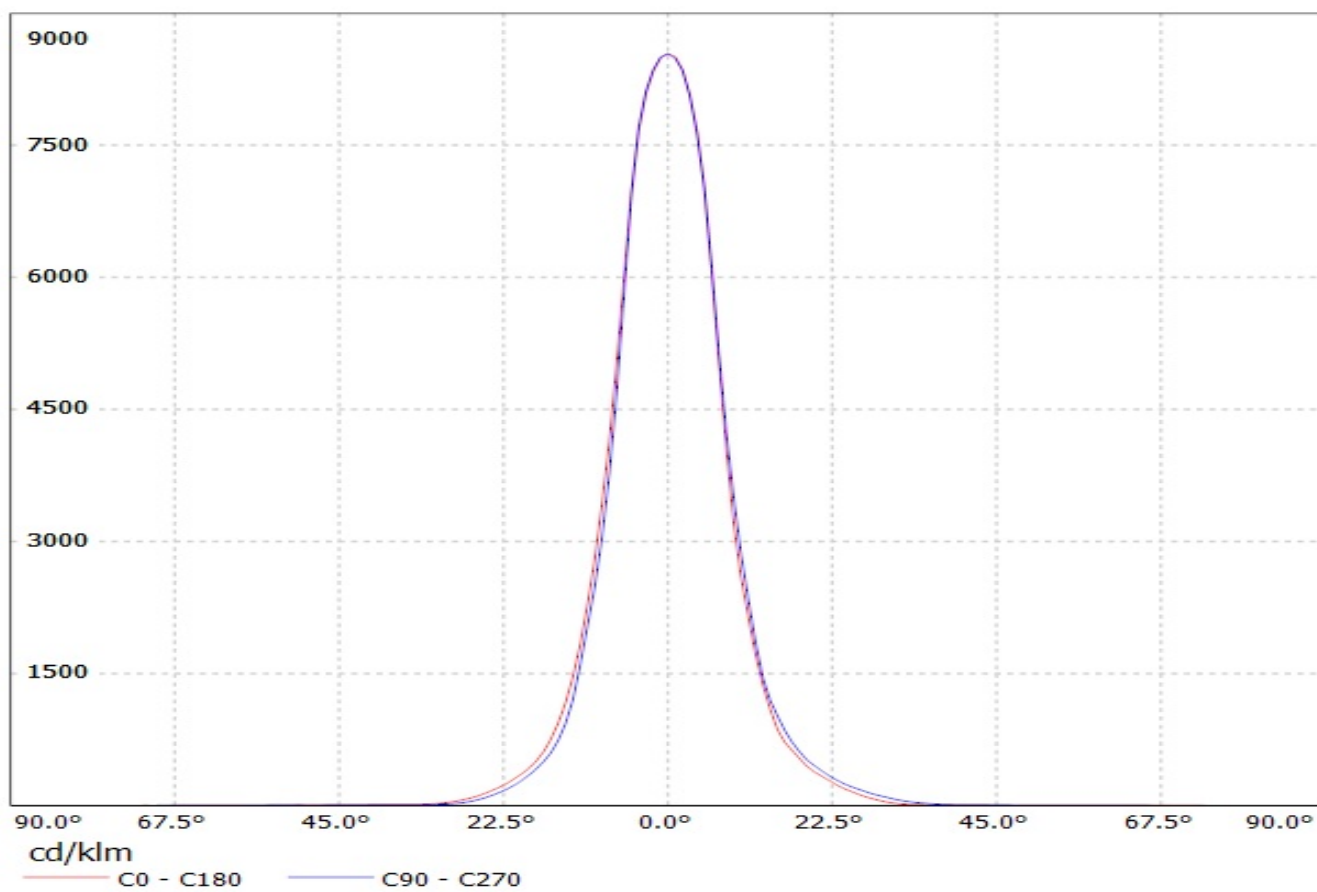

Luminaire: Ledil Oy C13528\_VERONICA-RS\_(XB-H)

Lamps: 1 x Cree XB-H (XBHAWT-0-3C0-T50-0B-0001) 109lm @ 250mA CCT= P=0.73W I=250mA

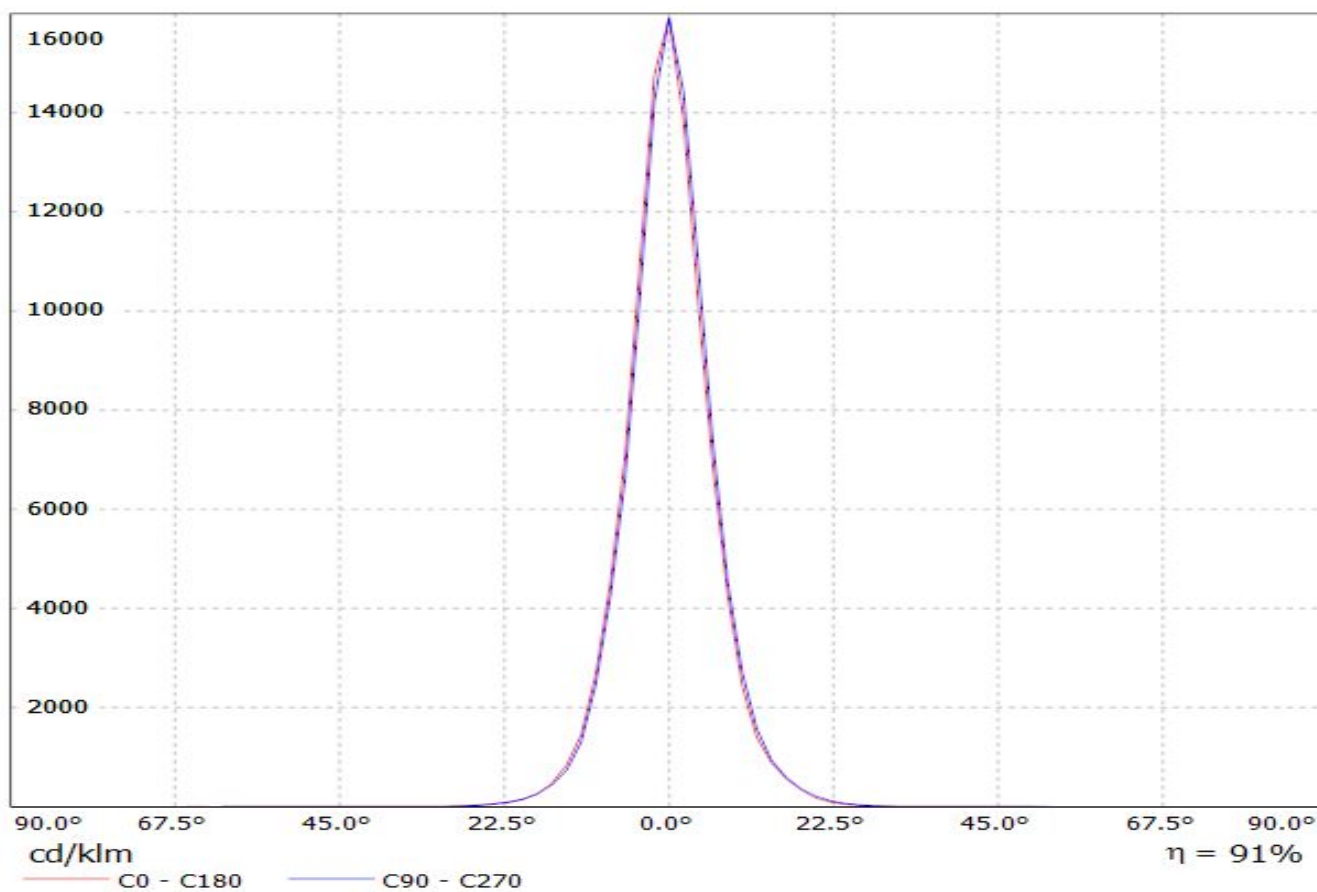

Luminaire: Ledil Oy C13528\_VERONICA-RS\_(Luxeon\_A) Efficiency=89%  
Lamps: 1 x Philips Lumileds Luxeon A (66lm @ 250mA) CCT=2900K P=0.8W I=250mA

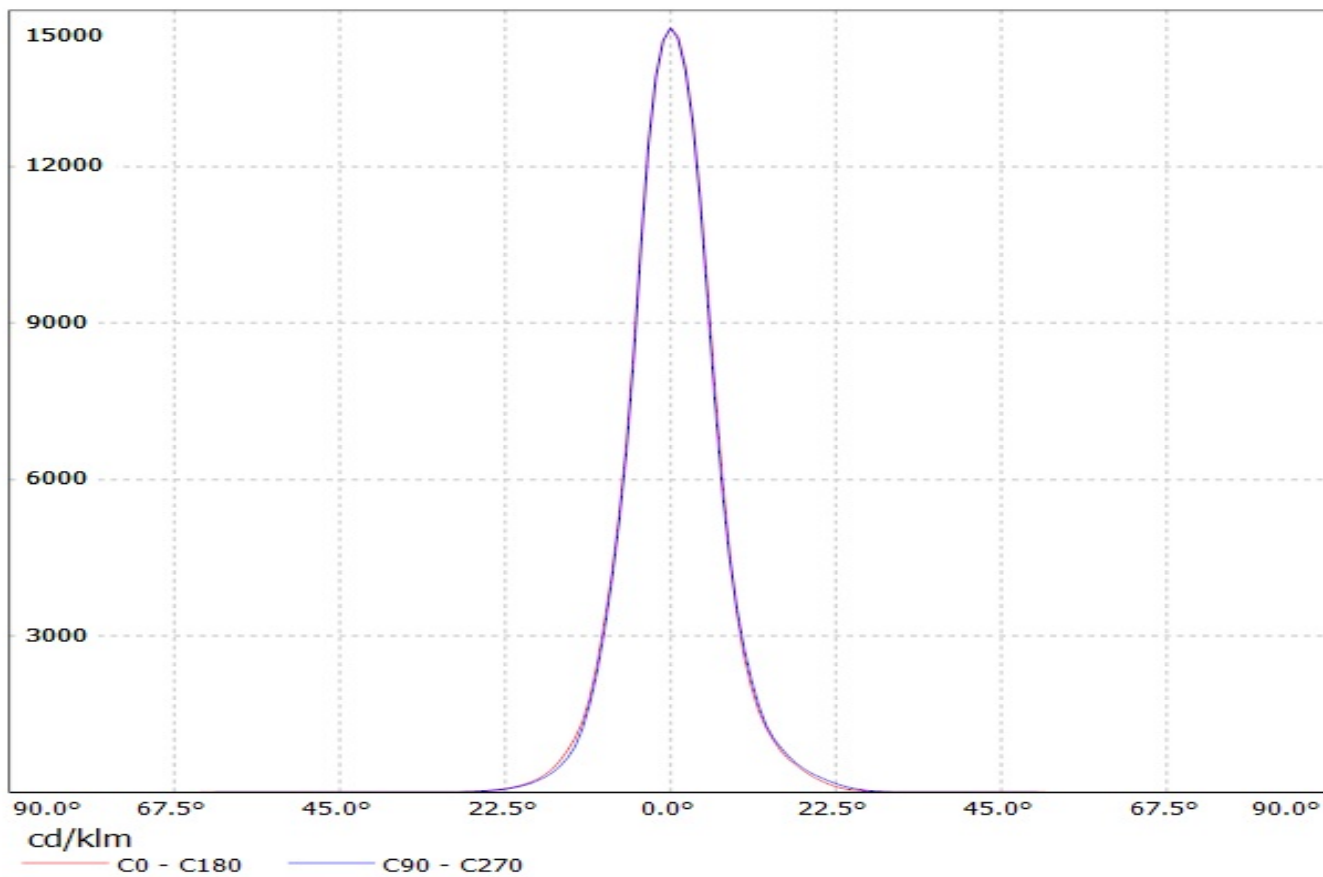

Luminaire: Ledil Oy C13528\_VERONICA-RS\_(Luxeon\_Rebel) Efficiency=88%  
Lamps: 1 x Philips Lumileds Luxeon Rebel (LXM8-PW40) 71lm @ 250mA CCT=2900k P=0.8W I=250mA

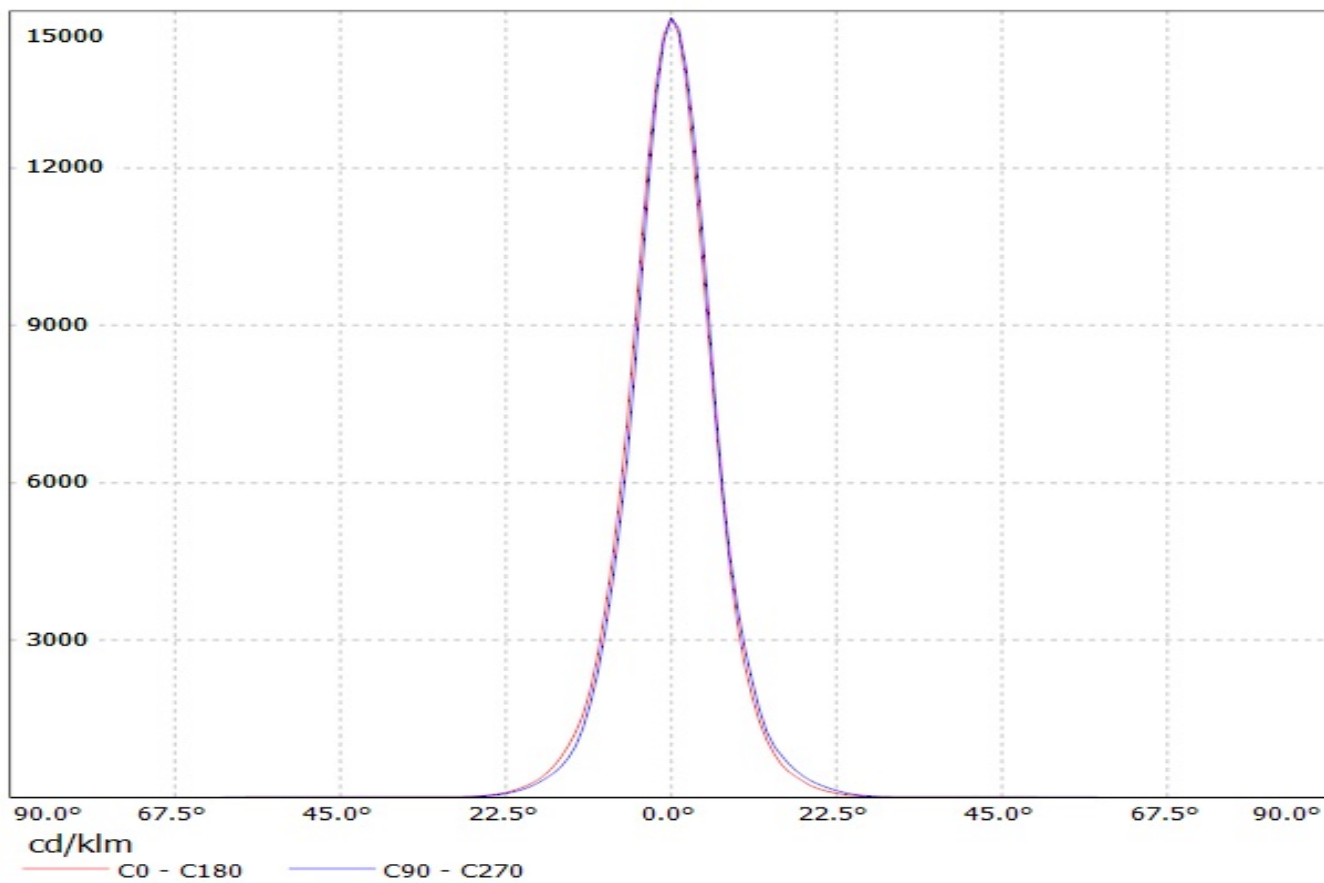



Luminaire: Ledil Oy C13528\_VERONICA-RS\_(NVSxx19B) Efficiency=87%  
Lamps: 1 x Nichia NVSxx19B (108lm @ 250mA) CCT=5400K P=0.8W I=250mA

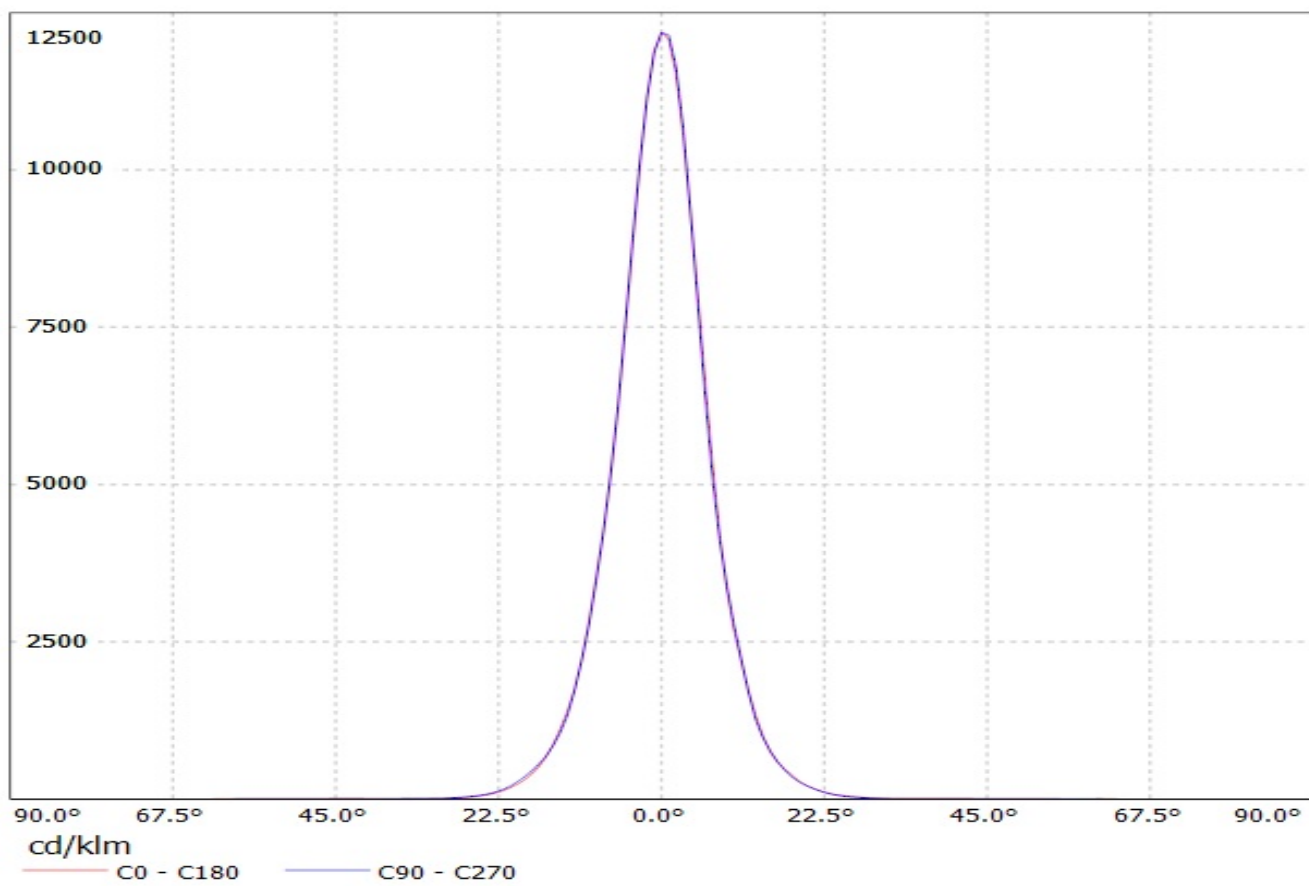

Luminaire: Ledil Oy C13528\_VERONICA-RS\_(NCSxx19A) Efficiency=86%  
Lamps: 1 x Nichia NCSxx19A (48lm @ 250mA) CCT=48 P=0.8W I=250mA

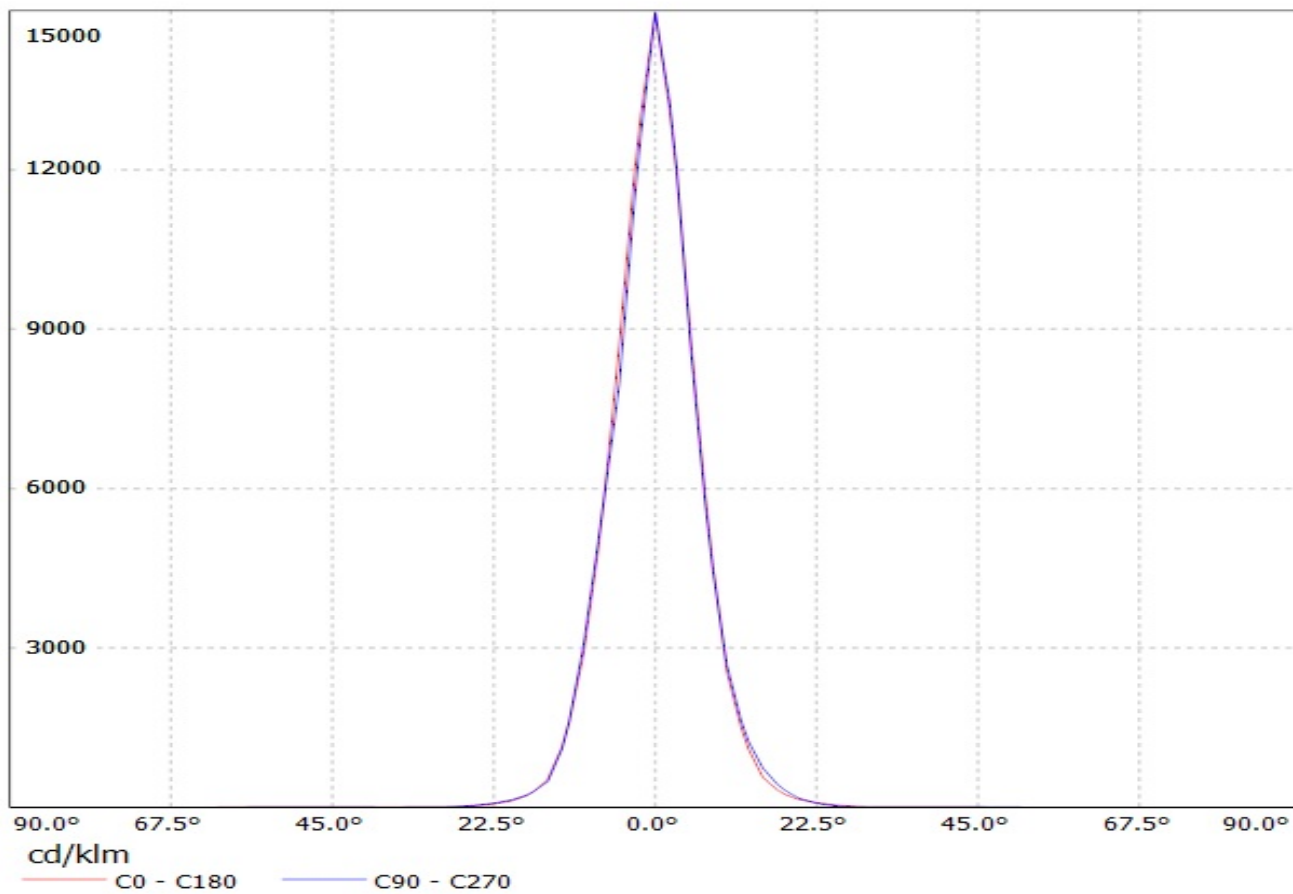

Luminaire: Ledil Oy C13528\_VERONICA-RS\_(NVSxx19A) Efficiency=85%  
Lamps: 1 x Nichia NVSxx19A (98lm @ 250mA) CCT=5300K P=0.8W I=250mA

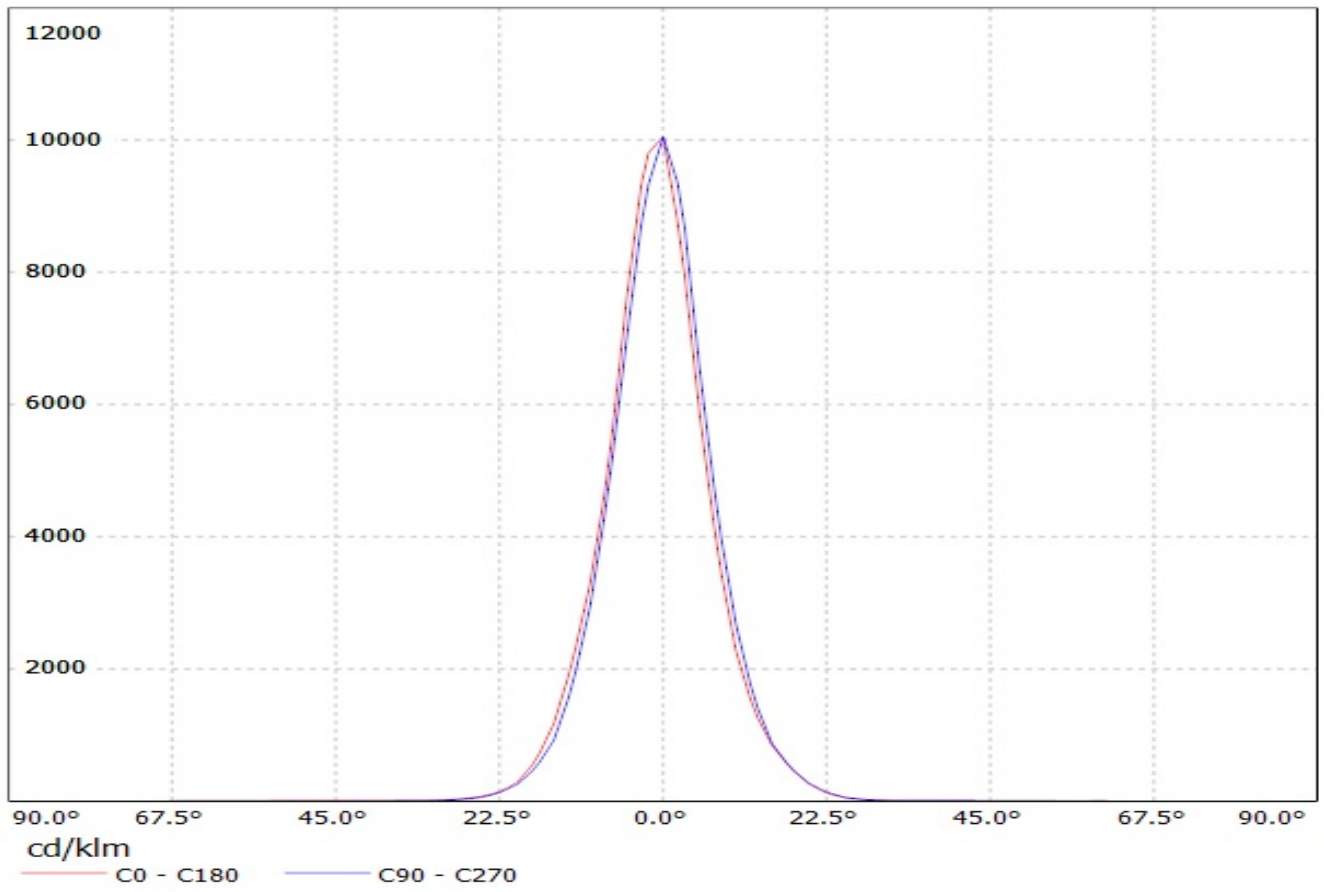

Luminaire: LEDiL Oy C13528\_VERONICA-RS\_(NVSW3x9A)

Lamps: 1 x Nichia\_NVSW3x9A\_(sm405/R70)\_122.334lm@250mA\_P=0.705435W\_I=0.250A

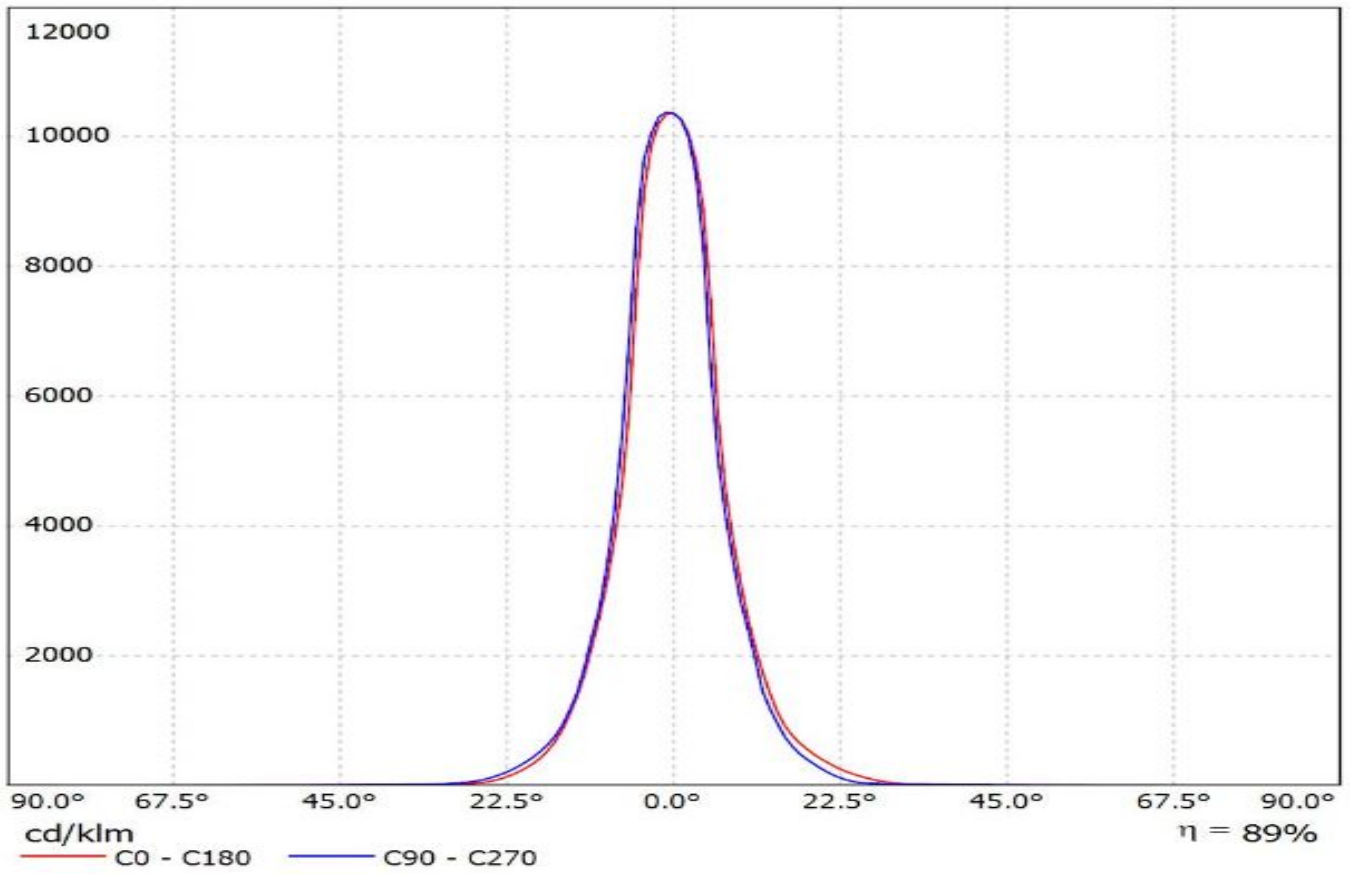

Luminaire: Ledil Oy C13528\_VERONICA-RS\_(LH351Z) Efficiency=89%  
Lamps: 1 x Samsung LH351Z (90.14lm @ 250mA) CCT=6500K P=0.7W I=250mA

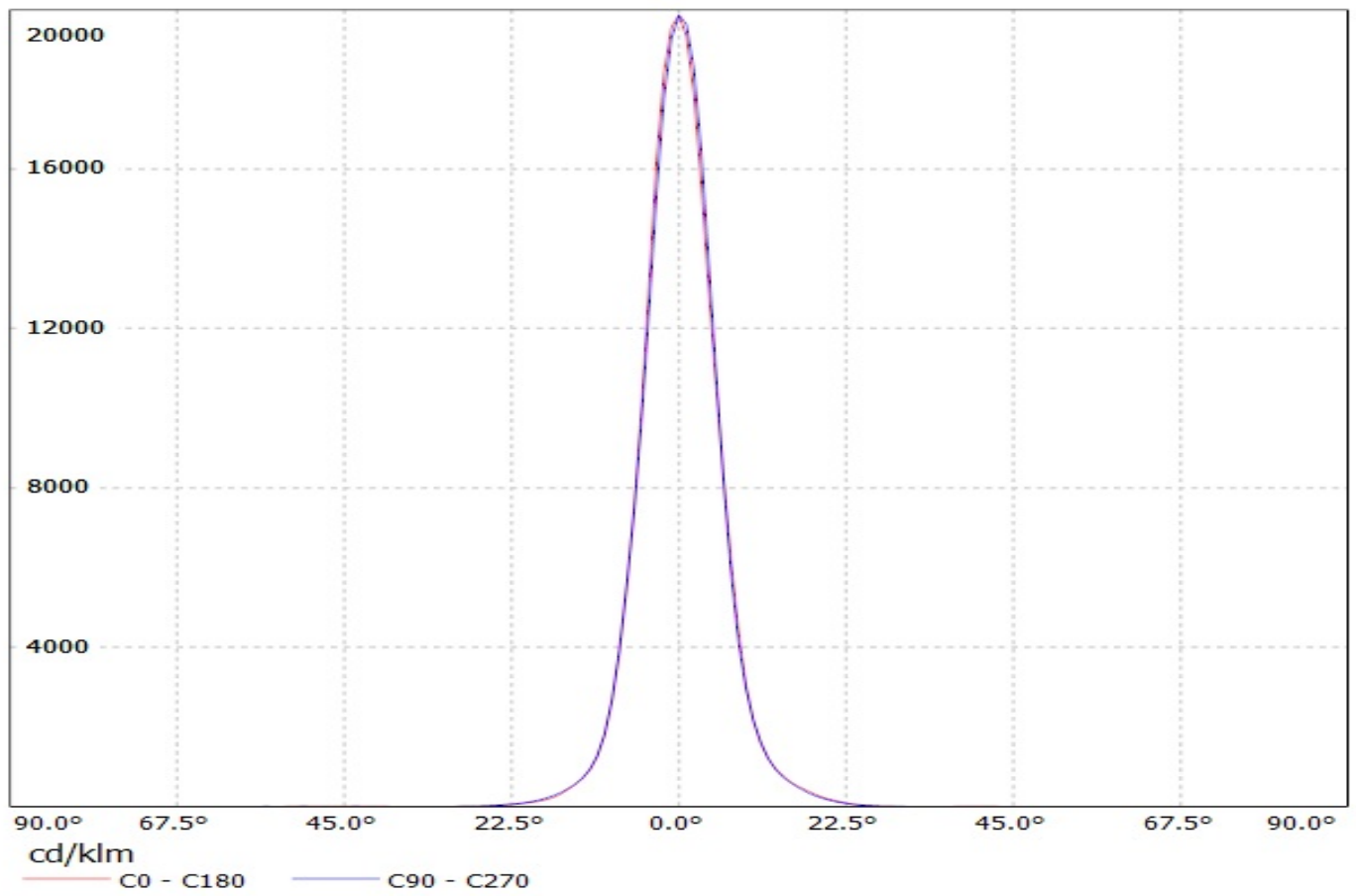

Luminaire: LEDiL Oy C13528\_VERONICA-RS\_(Z8Y22plus)

Lamps: 1 x Seoul\_Z8Y22plus\_(W6E2G)\_125.652lm@250mA\_P=0.69312W\_I=0.250A

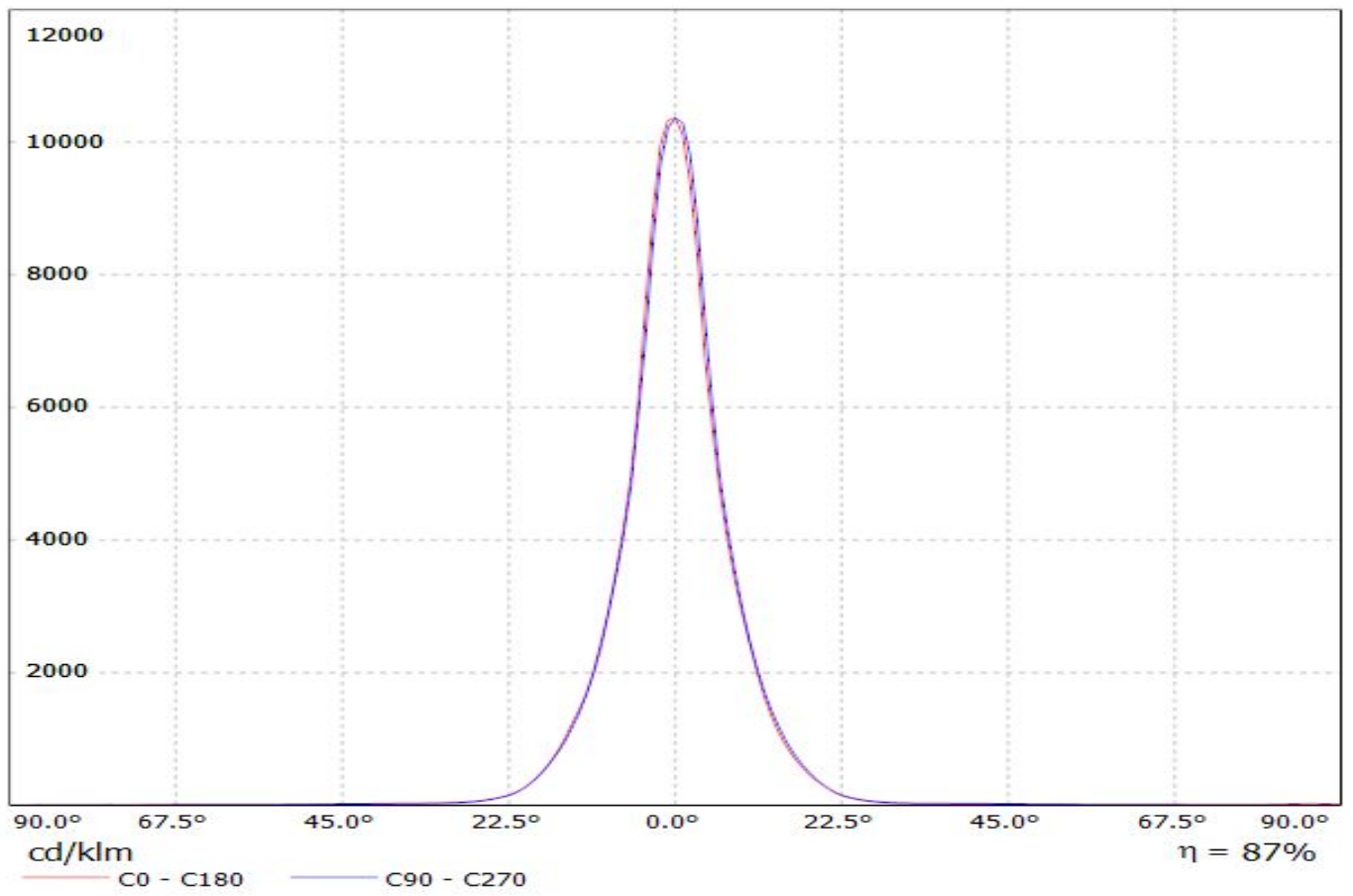

Luminaire: Ledil Oy C13528\_VERONICA-RS\_XP-G2\_Simulated\_100LM C13528\_VERONICA-RS\_XP-G2\_Simulated\_100LM  
Lamps: 1 x Cree XP-G2 100lm

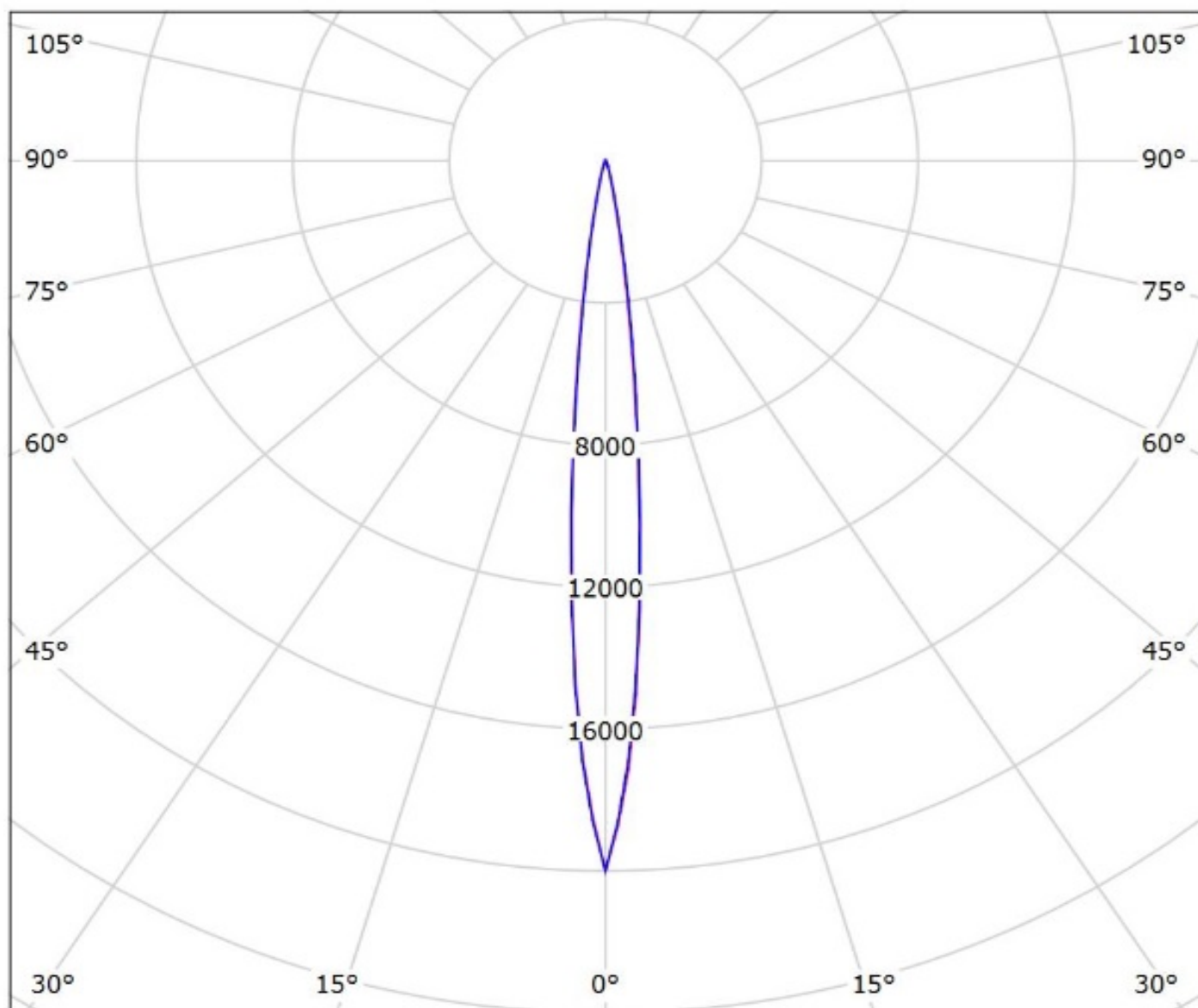

cd/klm

— C0 - C180 — C90 - C270

$\eta = 93\%$

Luminaire: Ledil Oy C13528\_VERONICA-RS\_(XP-G) Efficiency=90%  
Lamps: 1 x Cree XP-G (XPGWHT-L1-GWPI-00BE7) 67lm @ 250mA CCT=3100K P=0.8W I=250mA

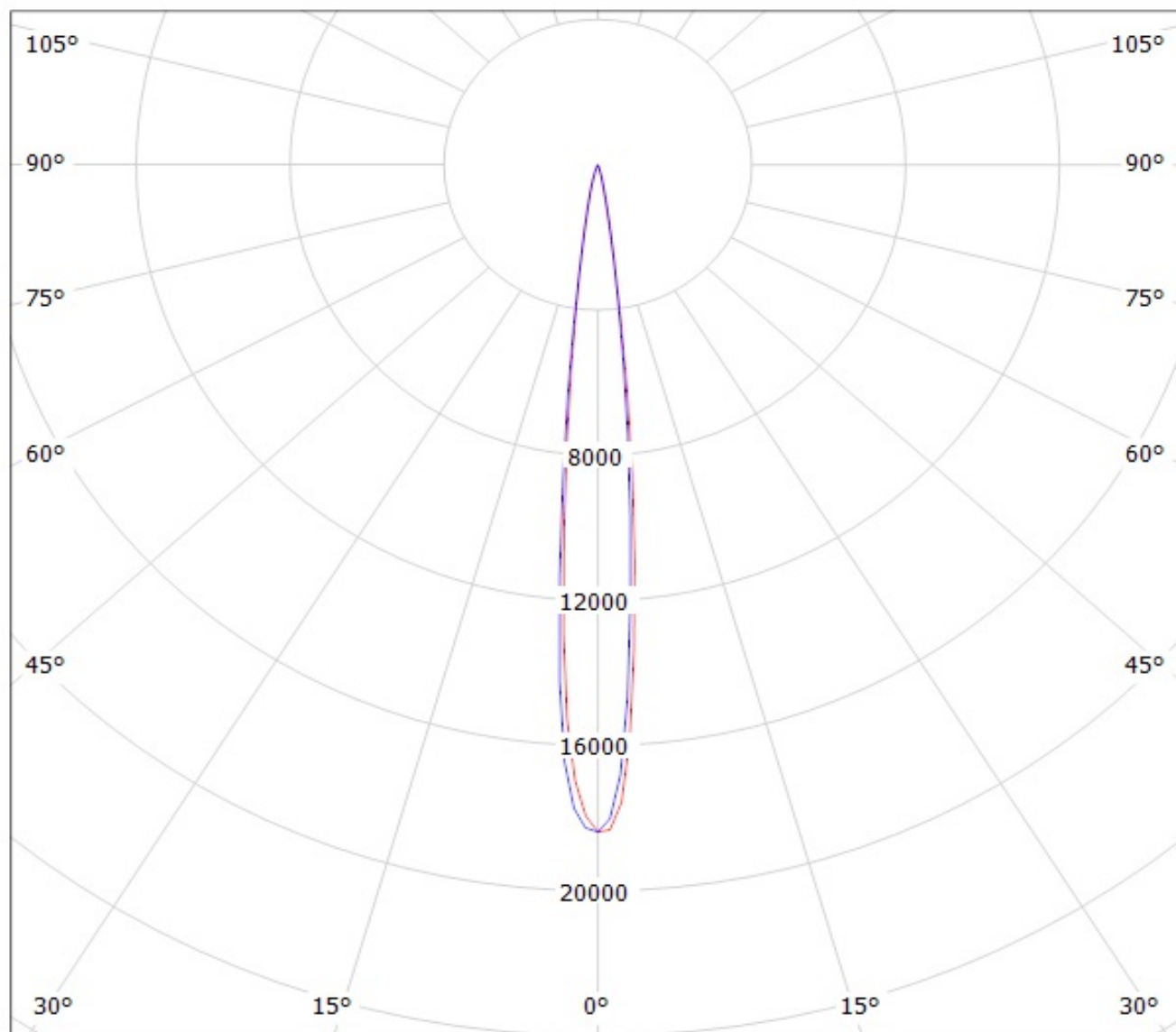

cd/klm

— C0 - C180

— C90 - C270



Luminaire: Ledil Oy C13528\_VERONICA-RS\_(XM-L2) Efficiency=90%

Lamps: 1 x Cree Xm-L2 (XMLBWT-0-7B4-T30-0L-001) 91lm @ 250mA CCT=3200K P=0.7W I=250mA

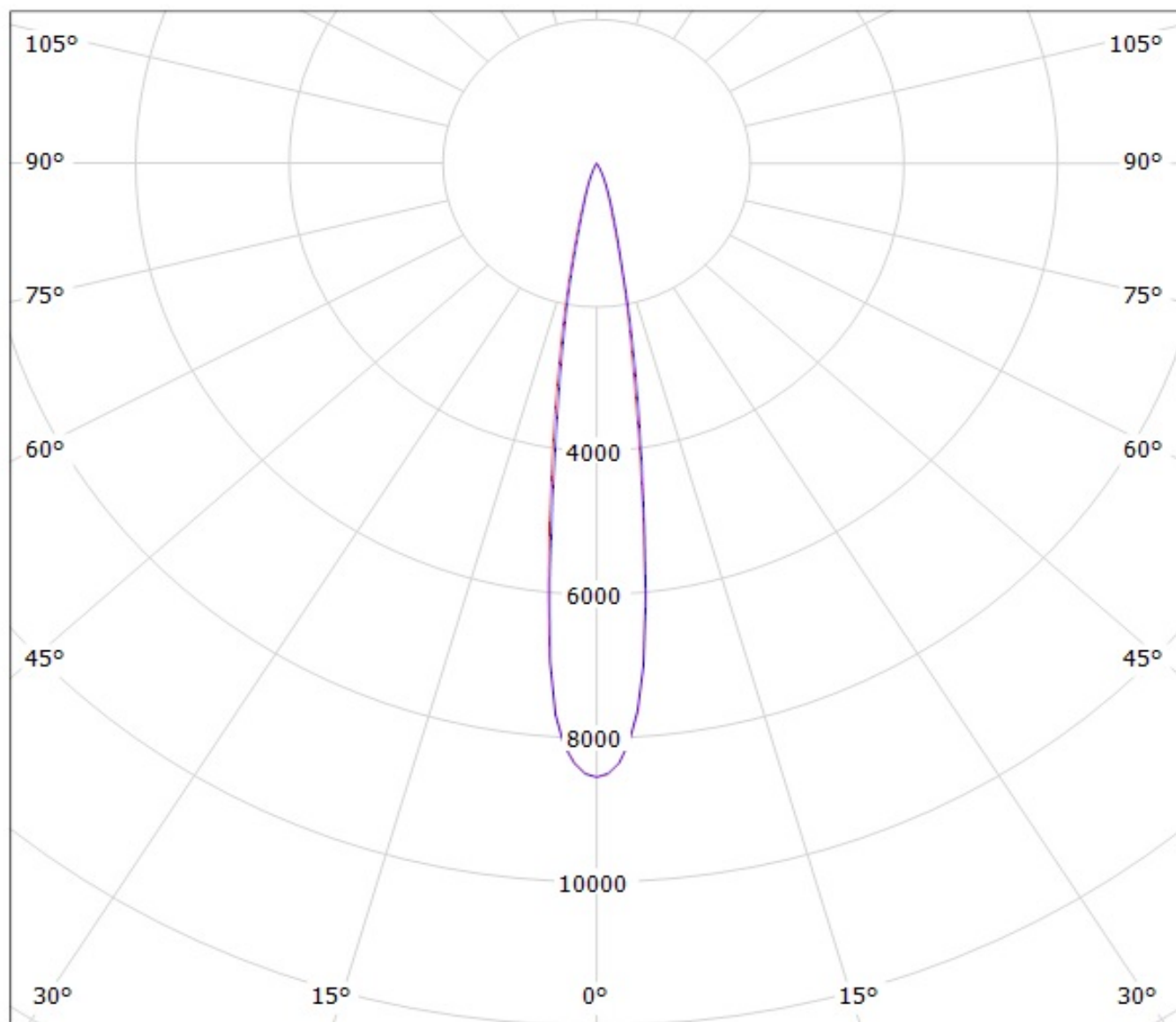

cd/klm

— C0 - C180

— C90 - C270

Luminaire: Ledil Oy C13528\_VERONICA-RS\_(XB-H)

Lamps: 1 x Cree XB-H (XBHAWT-0-3C0-T50-0B-0001) 109lm @ 250mA CCT= P=0.73W I=250mA

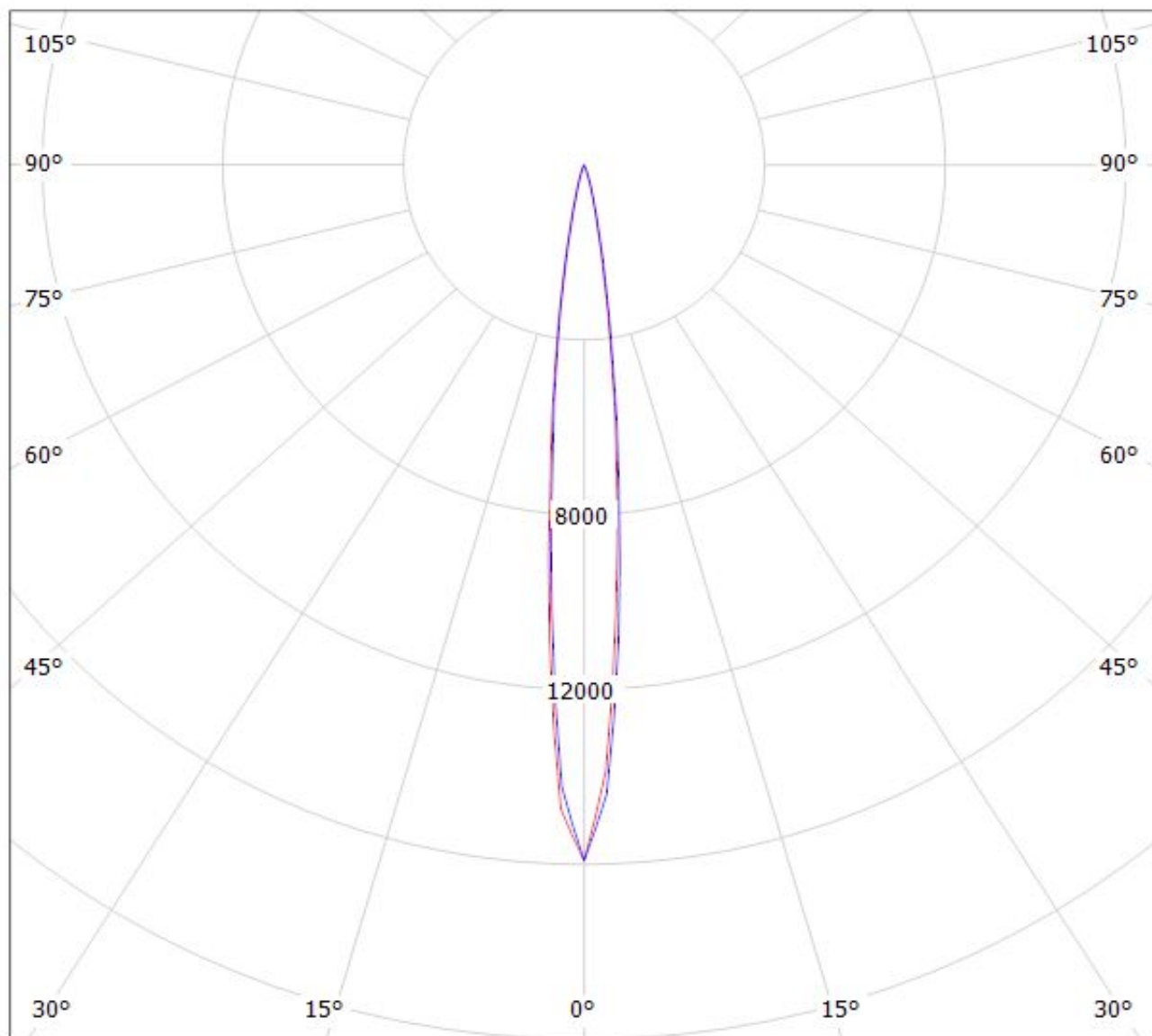

cd/klm

$\eta = 91\%$

— C0 - C180

— C90 - C270

Luminaire: Ledil Oy C13528\_VERONICA-RS\_(Luxeon\_A) Efficiency=89%  
Lamps: 1 x Philips Lumileds Luxeon A (66lm @ 250mA) CCT=2900K P=0.8W I=250mA

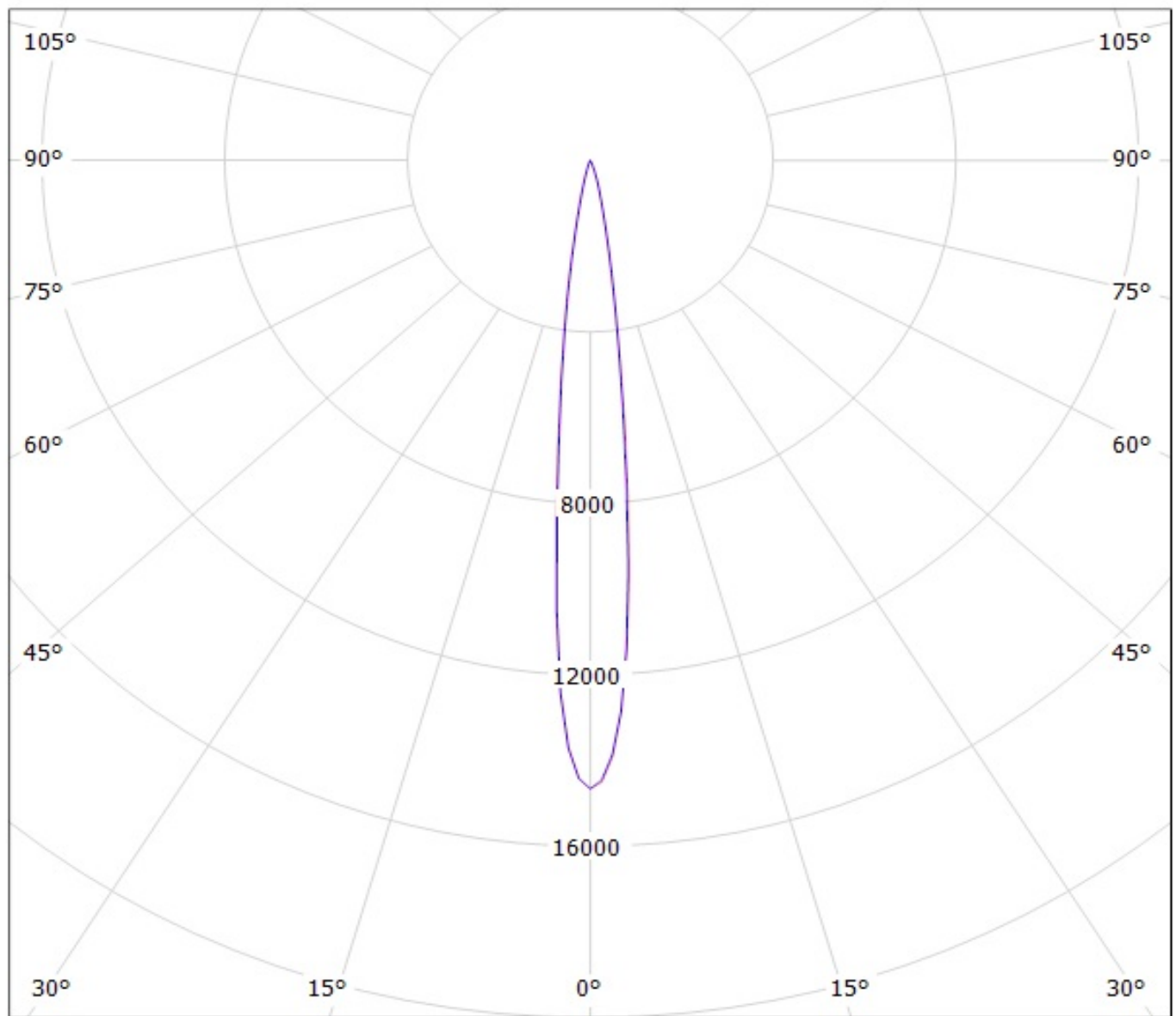

cd/klm

— C0 - C180

— C90 - C270

Luminaire: Ledil Oy C13528\_VERONICA-RS\_(Luxeon\_Rebel) Efficiency=88%  
Lamps: 1 x Philips Lumileds Luxeon Rebel (LXM8-PW40) 71lm @ 250mA CCT=2900k P=0.8W I=250mA

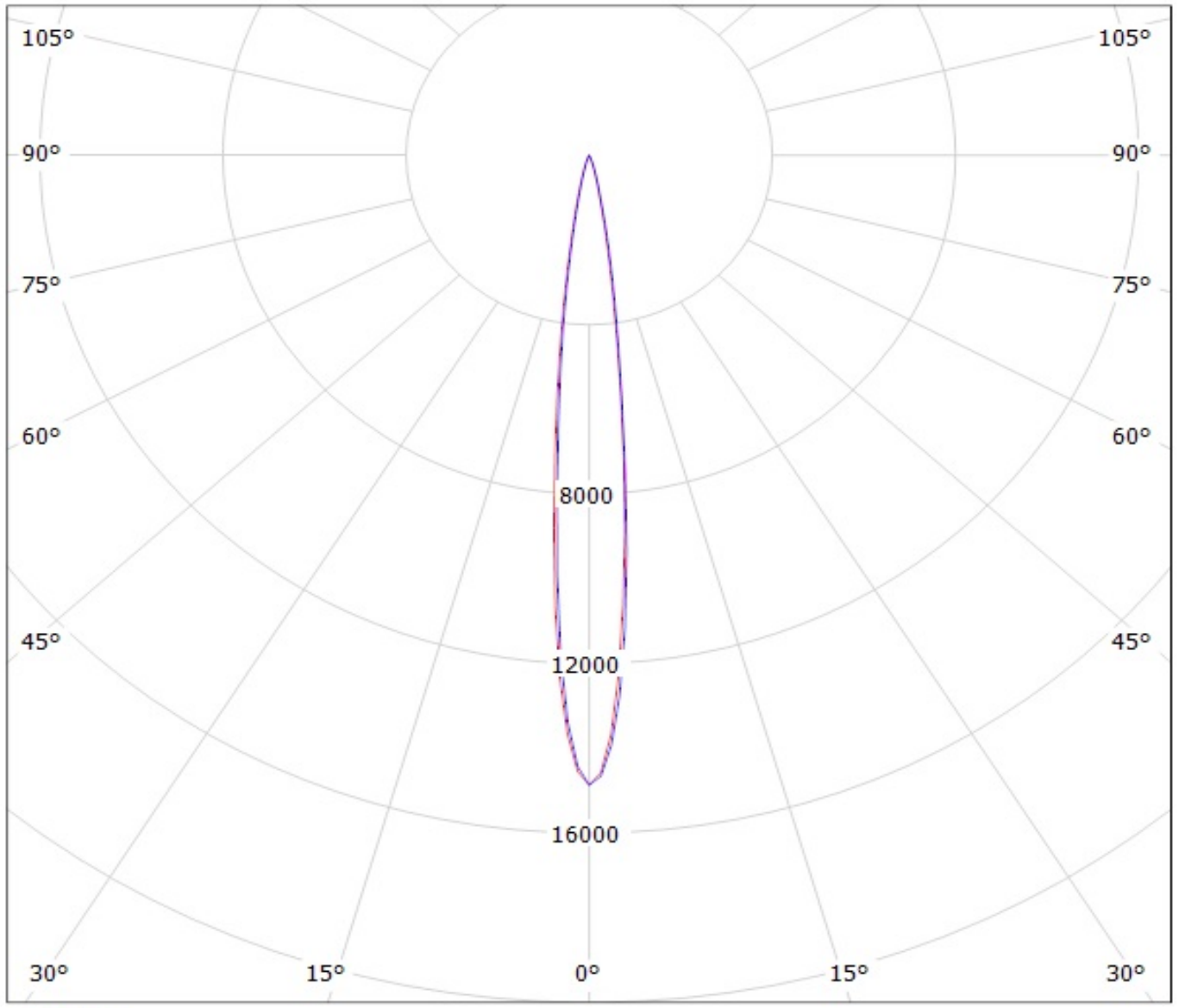

cd/klm  
— C0 - C180    — C90 - C270

Luminaire: Ledil Oy C13528\_VERONICA-RS\_(NVSxx19B) Efficiency=87%  
Lamps: 1 x Nichia NVSxx19B (108lm @ 250mA) CCT=5400K P=0.8W I=250mA

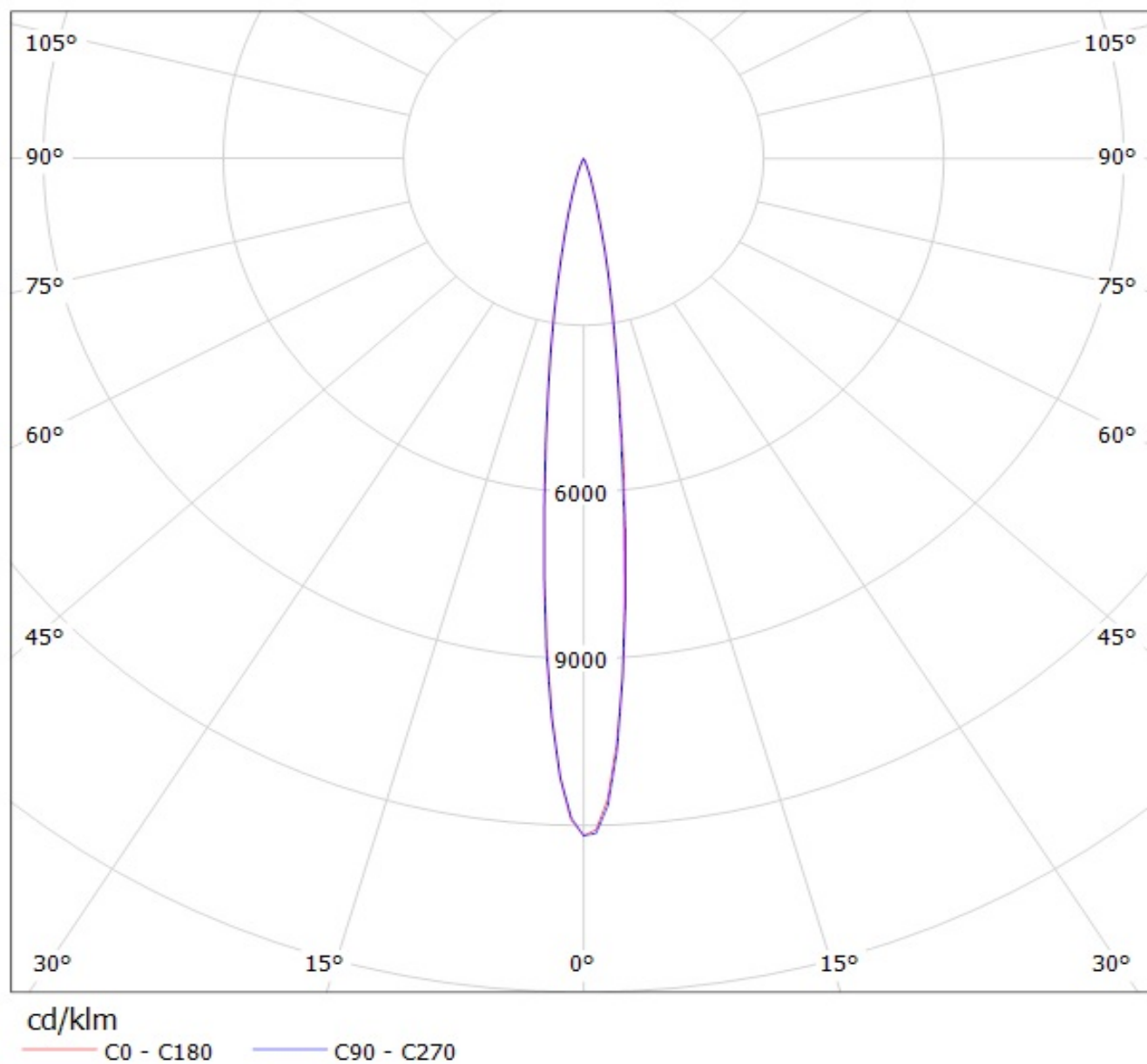

Luminaire: Ledil Oy C13528\_VERONICA-RS\_(NCSxx19A) Efficiency=86%  
Lamps: 1 x Nichia NCSxx19A (48lm @ 250mA) CCT=48 P=0.8W I=250mA

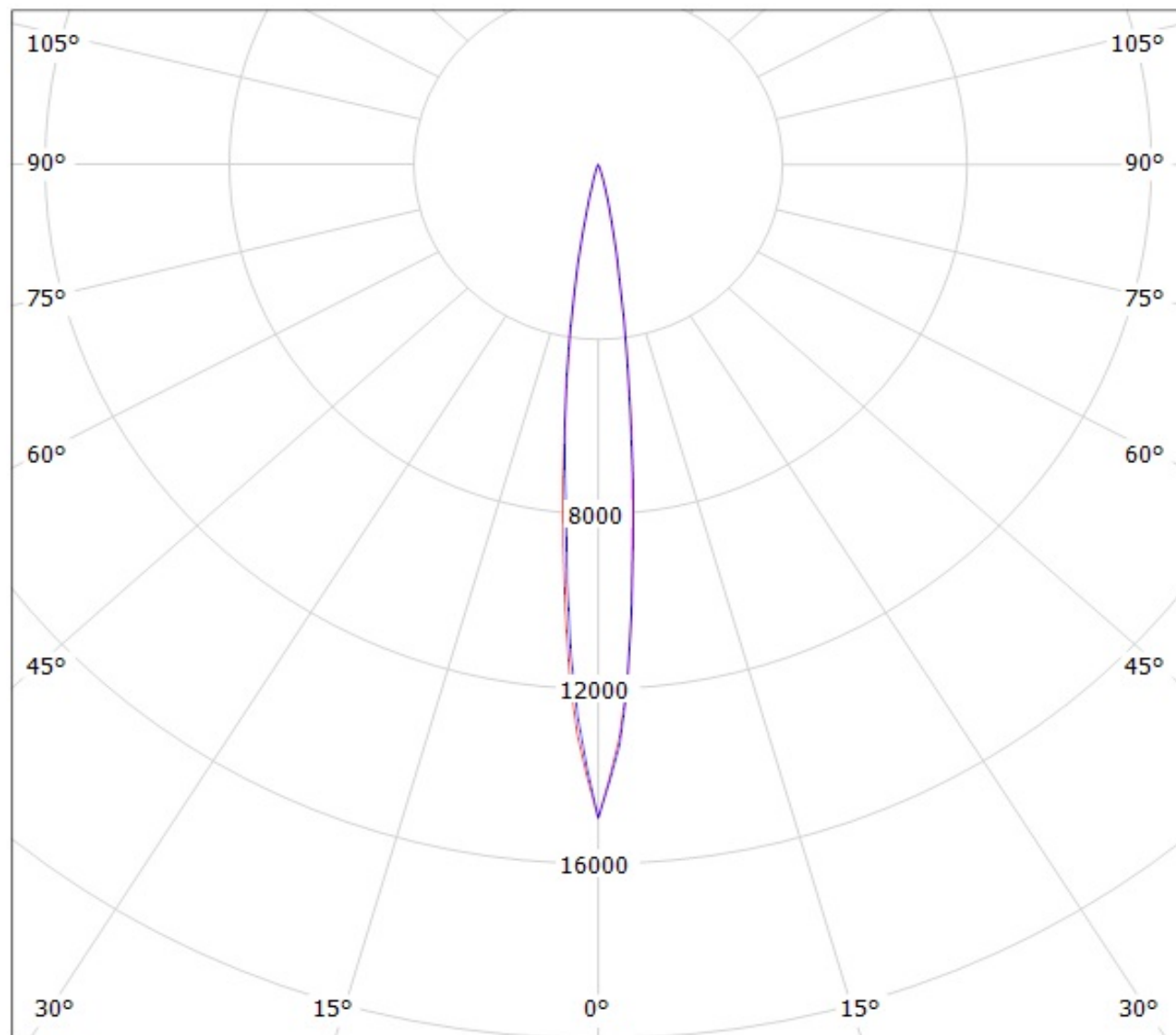

cd/klm

— C0 - C180

— C90 - C270

Luminaire: Ledil Oy C13528\_VERONICA-RS\_(NVSxx19A) Efficiency=85%  
Lamps: 1 x Nichia NVSxx19A (98lm @ 250mA) CCT=5300K P=0.8W I=250mA

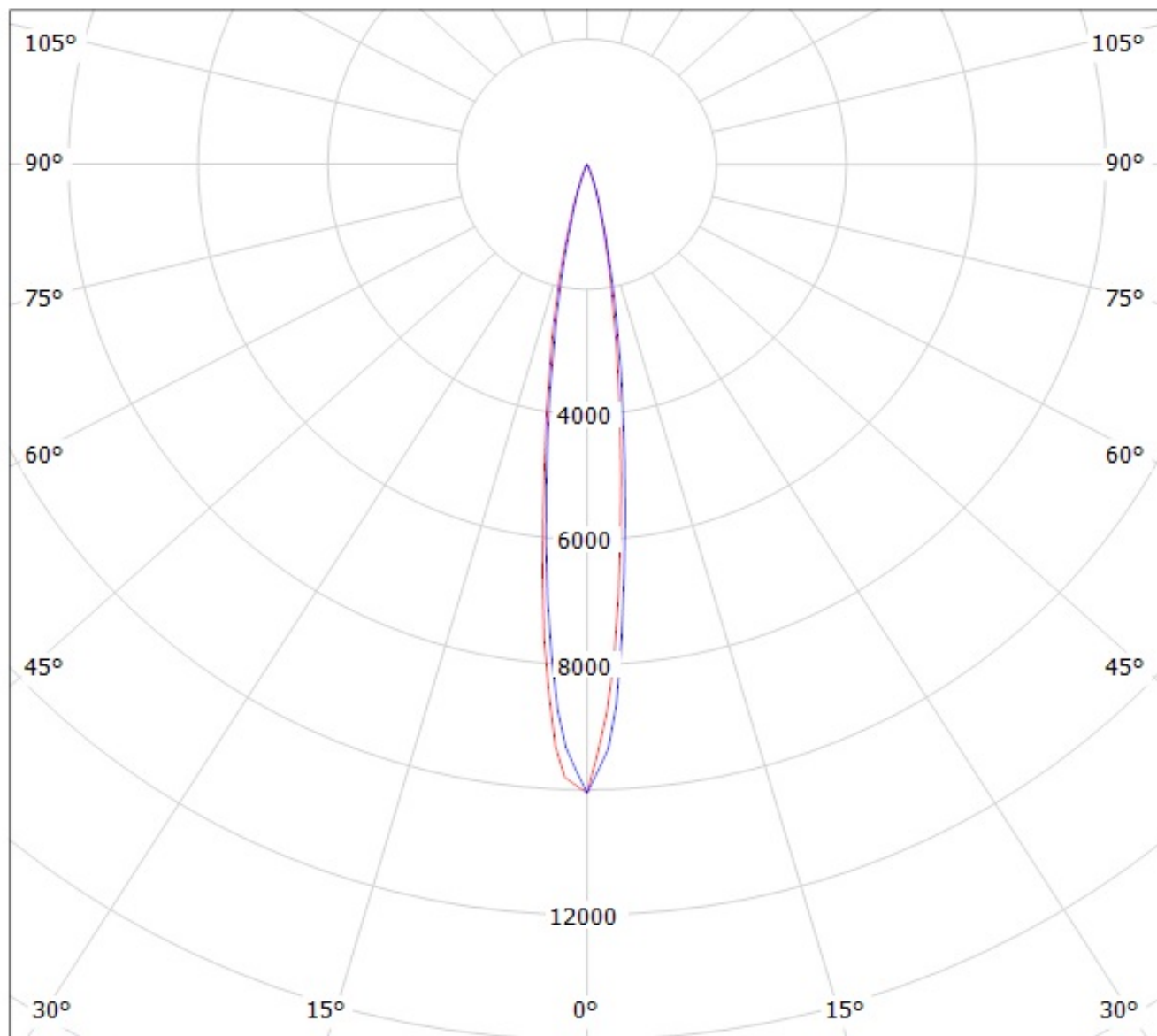

cd/klm

— C0 - C180

— C90 - C270

Luminaire: LEDiL Oy C13528\_VERONICA-RS\_(NVSW3x9A)

Lamps: 1 x Nichia\_NVSW3x9A\_(sm405/R70)\_122.334lm@250mA\_P=0.705435W\_I=0.250A

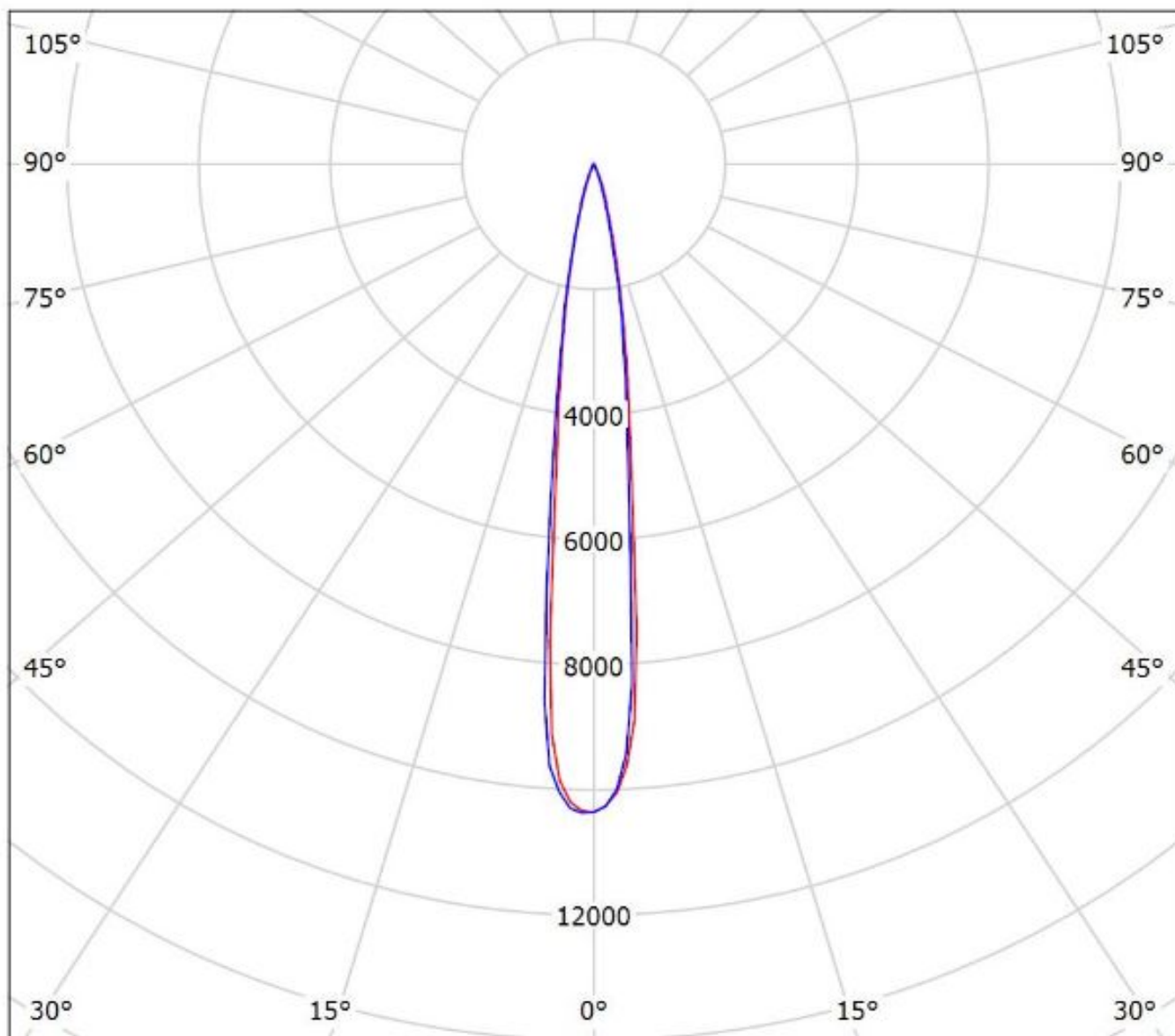

cd/klm

— C0 - C180 — C90 - C270

$\eta = 89\%$



Luminaire: Ledil Oy C13528\_VERONICA-RS\_(LH351Z) Efficiency=89%  
Lamps: 1 x Samsung LH351Z (90.14lm @ 250mA) CCT=6500K P=0.7W I=250mA

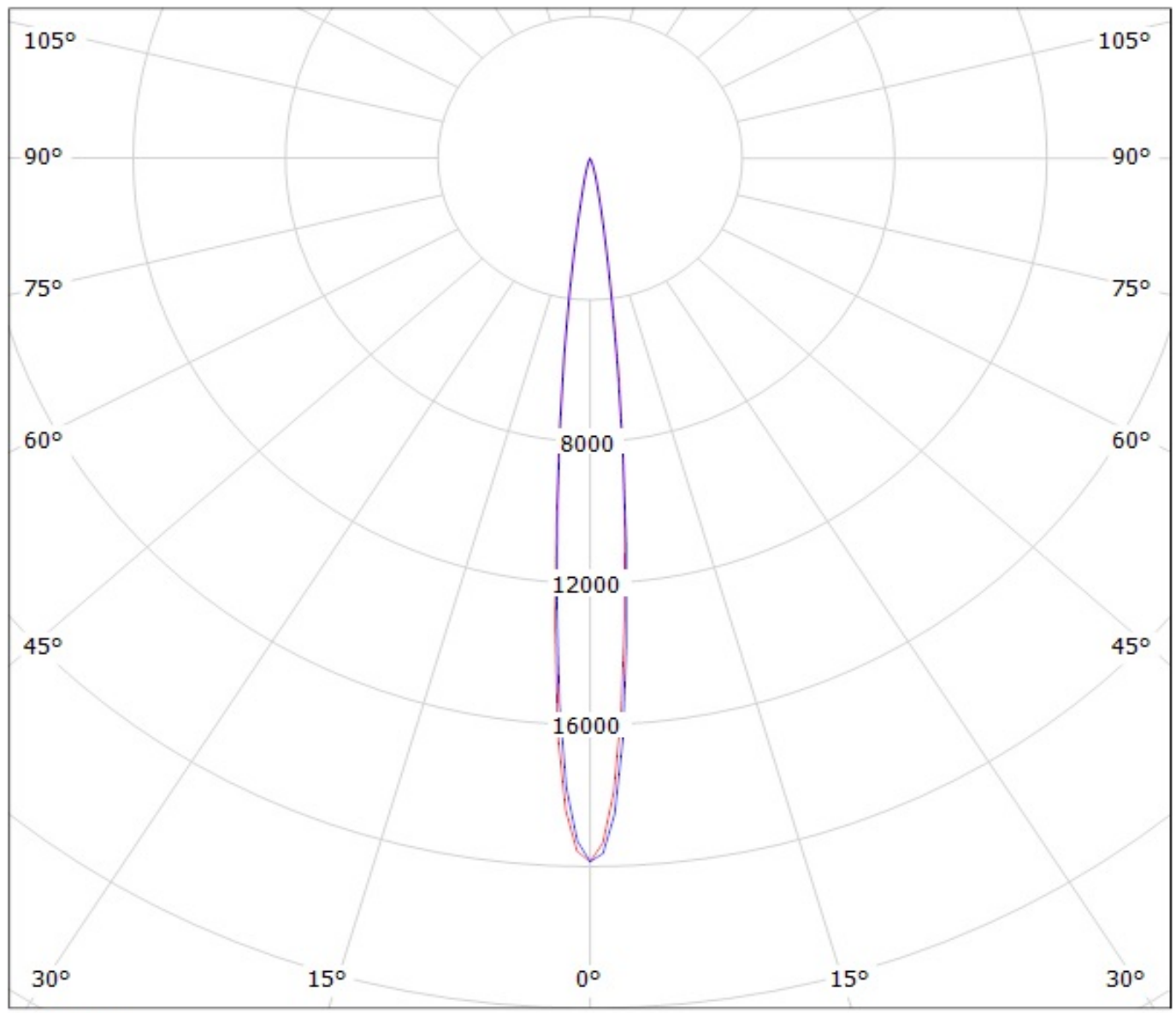

cd/klm  
— C0 - C180    — C90 - C270

Luminaire: LEDiL Oy C13528\_VERONICA-RS\_(Z8Y22plus)

Lamps: 1 x Seoul\_Z8Y22plus\_(W6E2G)\_125.652lm@250mA\_P=0.69312W\_I=0.250A

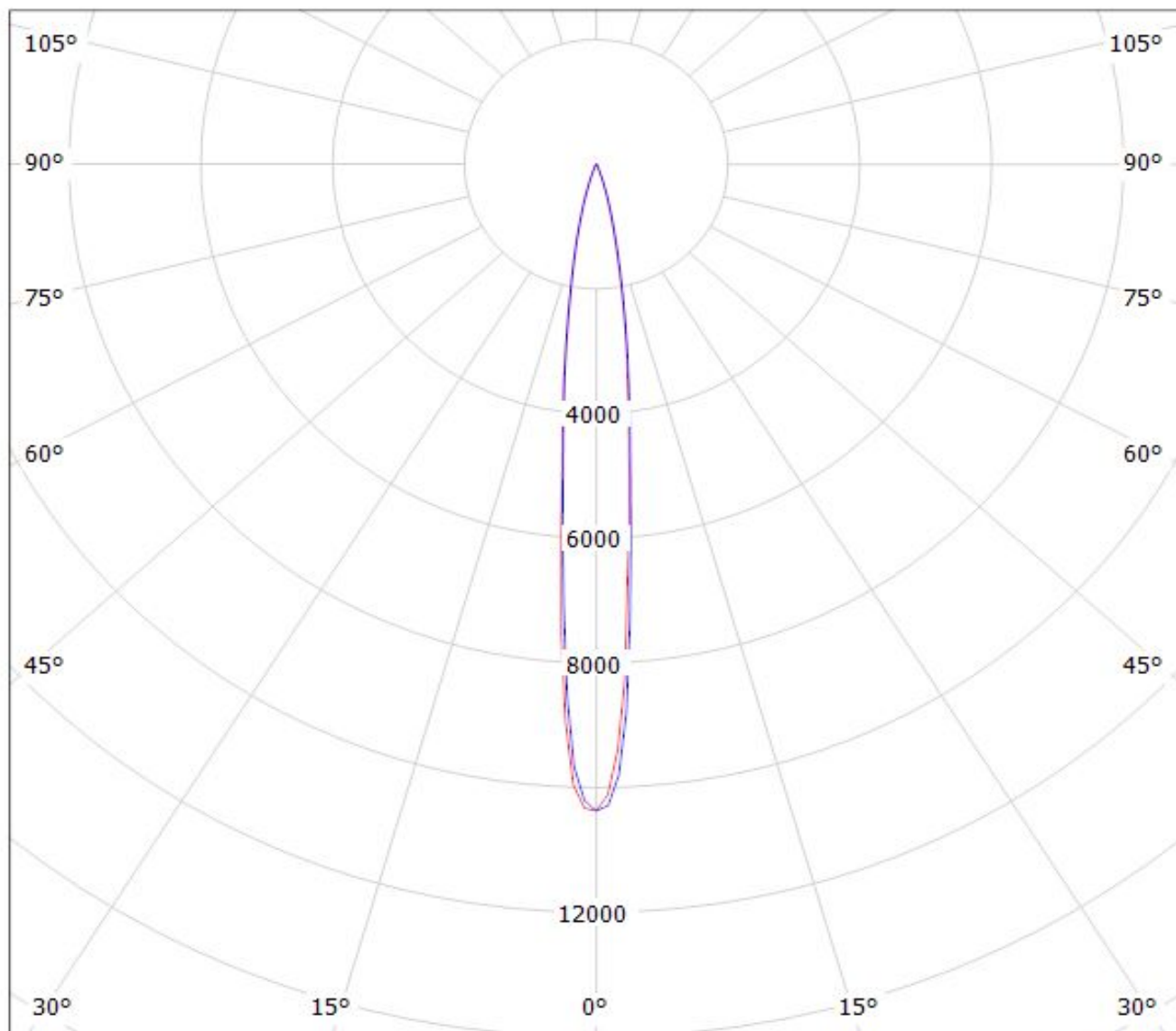

cd/klm

$\eta = 87\%$

— C0 - C180

— C90 - C270

**NOTE: The typical divergence will be changed by different color, chip size and chip position tolerance. The typical total divergence is the full angle measured where the luminous intensity is half of the peak value.**