

## Non-Dimmable, Off-Line, LED Driver with Low Total Harmonic Distortions

### Features

- Good LED Current Regulation
  - Better than 5% accuracy
- Valley Switching Buck-Boost Converter with Power Factor Correction (PFC)
  - 0.97 Power Factor (typical)
  - 5% Total Harmonic Distortion (THD) (typical)
- Uses a Standard Off-the-Shelf Inductor
  - No auxiliary winding required
- Single Input Voltage Range
  - HV98100: 110 V<sub>AC</sub> ±15%
  - HV98101: 230 V<sub>AC</sub> ±15%
- Supports 5W-15W Output Power
- Space-saving SOT-23-6L Package

### Applications

- LED Lamps
- LED Lighting Fixtures

### Description

The HV98100/HV98101 LED driver integrated circuit (IC) is an off-line, high-power factor, buck-boost controller targeted at general LED lighting products, such as LED lamps and LED lighting fixtures with a maximum power rating of about 15W.

Valley-switching buck-boost converters are preferred in off-line applications since they reduce switching losses. A typical solution is to pair a constant on-time control scheme with valley switching to achieve both a high-power factor and good efficiency. However, this control scheme results in a higher total harmonic distortion, and the actual value is dependent on the input and output voltages. The HV98100/HV98101 uses a unique control scheme to achieve a high-power factor and low THD simultaneously under all line and load conditions, while maximizing efficiency utilizing valley switching. The average LED current is also controlled in a closed-loop manner to achieve high LED accuracy.

Other unique features of the ICs are the bootstrap of the IC supply voltage from the output, as well as the unique valley-sensing scheme that allows the use of a standard off-the-shelf inductor to minimize the overall system cost.

Applications with low-output voltage can be accommodated using a coupled inductor.

### Package Types

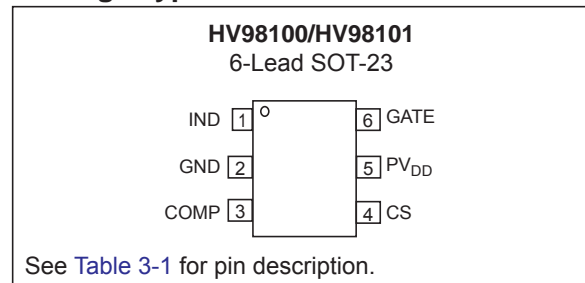



## 1.0 ELECTRICAL CHARACTERISTICS

### Absolute Maximum Ratings†

Supply Voltage PV <sub>DD</sub> to GND .....	-0.3V to +20V
GATE to GND .....	-0.3V to (PV <sub>DD</sub> + 0.5V)
CS, COMP, IND to GND .....	-0.3V to 4.5V
Operating Junction Temperature .....	-40°C to +125°C
Storage Temperature .....	-65°C to +150°C
Power Dissipation at +25°C for 6L-SOT-23 .....	800 mW
ESD Protection on all pins (HBM) .....	2 kV
ESD Protection on all pins (MM) .....	175V

\* Based on JEDEC JESD51 testing and reporting standards

† **Notice:** Stresses above those listed under “Maximum Ratings” may cause permanent damage to the device. This is a stress rating only and functional operation of the device at those or any other conditions above those indicated in the operational sections of this specification is not intended. Exposure to maximum rating conditions for extended periods may affect device reliability.

### ELECTRICAL CHARACTERISTICS

**Electrical Specifications:** Unless otherwise specified, all specifications are for T<sub>A</sub> = T<sub>J</sub> = +25°C, PV<sub>DD</sub> = 12V. Boldface specifications apply over the full temperature range T<sub>A</sub> = T<sub>J</sub> = -40°C to +125°C.

Parameter	Symbol	Min.	Typ.	Max.	Units	Conditions
<b>Power Supply (PV<sub>DD</sub>)</b>						
PV <sub>DD</sub> Clamp Voltage	PV <sub>DD,clamp</sub>	<b>15.5</b>	<b>17</b>	<b>18.5</b>	V	Current into PV <sub>DD</sub> = 4.0 mA; C <sub>GATE</sub> = 500 pF; f <sub>sw</sub> = 100 kHz;
V <sub>DD</sub> Start Voltage	V <sub>DD,ON</sub>	<b>14.5</b>	<b>16</b>	<b>17.5</b>	V	GATE starts switching
V <sub>DD</sub> Stop Voltage	V <sub>DD,OFF</sub>	<b>6.5</b>	<b>8</b>	<b>9.5</b>	V	GATE stops switching
Current into clamp	I <sub>DD,max</sub>	—	—	5	mA	<b>Note 1</b>
Current drawn by IC before start	I <sub>DD,Q</sub>	—	—	200	μA	Measured at PV <sub>DD</sub> = 12V after PV <sub>DD</sub> rises from 0V to 12V
Current drawn by IC during operation	I <sub>DD,OP</sub>	—	—	4.3	mA	C <sub>GATE</sub> = 500 pF; f <sub>sw</sub> = 100 kHz; COMP = 3V; I <sub>INDSINK</sub> = 200 μA; I <sub>INDSOURCE</sub> = 250 μA
<b>Gate Driver</b>						
GATE Driver Sourcing Current	I <sub>SOURCE</sub>	0.3	—	—	A	<b>Note 2</b>
Gate Driver Sinking Current	I <sub>SINK</sub>	0.6	—	—	A	<b>Note 2</b>
Gate Rise Time (10%-90%)	T <sub>RISE</sub>	—	—	45	ns	C <sub>GATE</sub> = 500 pF
Gate Fall Time (10%-90%)	T <sub>FALL</sub>	—	—	23	ns	C <sub>GATE</sub> = 500 pF
<b>Output Current Control</b>						
Internal Reference Voltage	CS <sub>REF</sub>	194	204	214	mV	<b>Note 2</b>
OTA Offset Voltage	V <sub>OFFSET</sub>	-7.5	—	7.5	mV	<b>Note 2</b>
Open Loop DC Gain	A <sub>V</sub>	55	—	—	dB	1V ≤ COMP ≤ 4V; Output open <b>Note 1</b>
Small Signal Transconductance	g <sub>m</sub>	160	230	300	μA/V	1V ≤ COMP ≤ 4V; <b>Note 1</b>
Gain Bandwidth Product	GBW	0.16	0.24	—	MHz	CCOMP = 150 pF <b>(Note 2)</b>

# HV98100/HV98101

## ELECTRICAL CHARACTERISTICS (CONTINUED)

**Electrical Specifications:** Unless otherwise specified, all specifications are for  $T_A = T_J = +25^\circ\text{C}$ ,  $PV_{DD} = 12\text{V}$ . Boldface specifications apply over the full temperature range  $T_A = T_J = -40^\circ\text{C}$  to  $+125^\circ\text{C}$ .

Parameter	Symbol	Min.	Typ.	Max.	Units	Conditions
$R_{ON}$ of COMP Reset FET	$R_{COMP}$	300	400	500	$\Omega$	
<b>Internal Clocks</b>						
Start-up Clock	$F_{start}$	6.25	10	15	kHz	
Maximum Frequency Limit	$F_{max}$	217	320	480	kHz	<b>Note 1</b>
<b>Valley Detect</b>						
Current into IND pin	$I_{IND}$	—	—	600	$\mu\text{A}$	<b>Note 2</b>
Voltage at IND pin	$V_{IND}$	3.87	4.3	4.73	V	$I_{IND} = 250 \mu\text{A}$
Comparator Delay Time	$T_{delay}$	—	—	50	ns	<b>Note 2</b>
<b>Control Circuit</b>						
Internal Timing Constant	$K_T$	—	1.25	—	$\mu\text{s}$	
Internal Voltage for Timing	$V_{Tref}$	—	2	—	V	HV98100
		—	2.5	—	V	HV98101
GATE On-time	$T_{ON}$	6.83	7.35	7.89	$\mu\text{s}$	HV98100 Ext Clk = 50 kHz COMP = 2V
	$T_{ON}$	6.11	6.7	7.05	$\mu\text{s}$	HV98101 Ext CSIk = 50 kHz COMP = 2V
<b>Protection</b>						
Over Voltage Protection Current Threshold	$I_{OVP}$	350	450	550	$\mu\text{A}$	GATE = LOW
Over Current Protection Reference	$OCP_{REF}$	2.2	2.35	2.5	V	
Over Current Protection Blanking Time	$T_{BLNKOCP}$	150	—	250	ns	<b>Note 2</b>
Detect time for Over Current Protection	$T_{DETOCP}$	150	—	250	ns	After TBLNKOCP ( <b>Note 2</b> )
Over Current Comparator Delay	$OCP_{DLY}$	—	50	100	ns	100 mV overdrive ( <b>Note 2</b> )

**Note 1:** Obtained by Design and Characterization; not 100% tested in production.

**2:** Design Guidance only.

**TABLE 1-1: TEMPERATURE SPECIFICATIONS**

Parameter	Symbol	Min.	Typ.	Max.	Units	Conditions
<b>Temperature Ranges</b>						
Storage Temperature	$T_A$	-65	—	+150	$^\circ\text{C}$	
Operating Junction Temperature	$T_J$	-40	—	+125	$^\circ\text{C}$	
<b>Thermal Package Resistance</b>						
Thermal Resistance, 6L-SOT-23	$\theta_{JA}$	—	<b>124</b>	—	$^\circ\text{C/W}$	
	$\theta_{JC}$	—	<b>74</b>	—	$^\circ\text{C/W}$	

## 2.0 TYPICAL OPERATING CURVES

**Note:** The graphs and tables provided following this note are a statistical summary based on a limited number of samples and are provided for informational purposes only. The performance characteristics listed herein are not tested or guaranteed. In some graphs or tables, the data presented may be outside the specified operating range (e.g., outside specified power supply range) and therefore outside the warranted range.

**Note:** Unless otherwise indicated,  $T_A = T_J = +25^\circ\text{C}$ ,  $PV_{DD} = 12\text{V}$ . Boldface specifications apply over the full temperature range  $T_A = T_J = -40^\circ\text{C}$  to  $+125^\circ\text{C}$ .

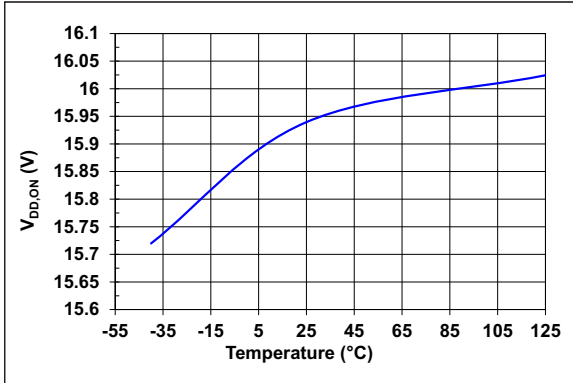

**FIGURE 2-1:**  $V_{DD}$  Start Voltage vs. Junction Temperature.

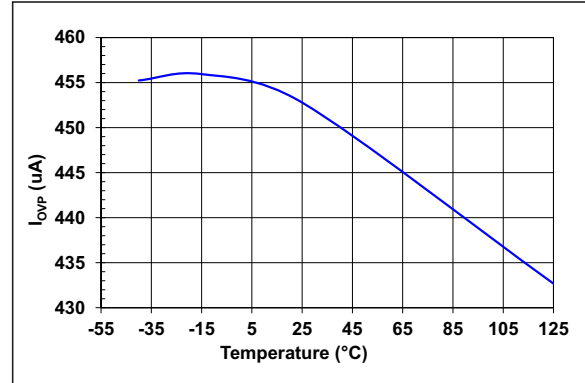

**FIGURE 2-4:** Over Voltage Protection Current Threshold vs. Junction Temperature.

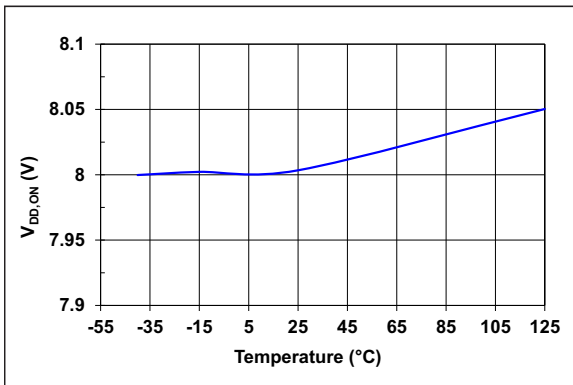

**FIGURE 2-2:**  $V_{DD}$  Stop Voltage vs. Junction Temperature.

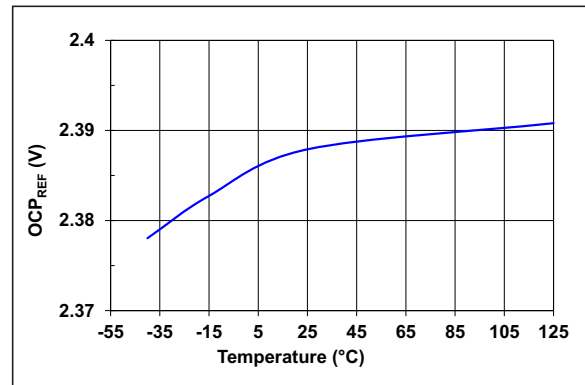

**FIGURE 2-5:** Over Current Protection Reference vs. Junction Temperature.

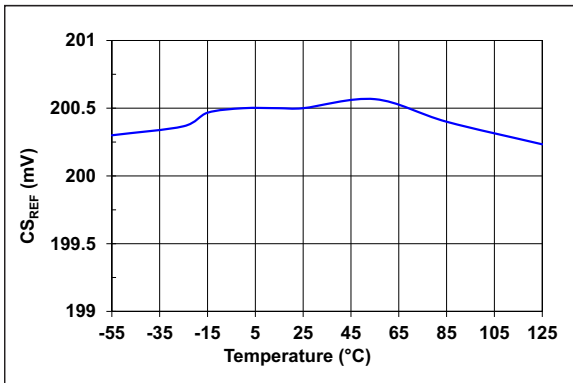

**FIGURE 2-3:** Internal Reference Voltage vs. Junction Temperature.

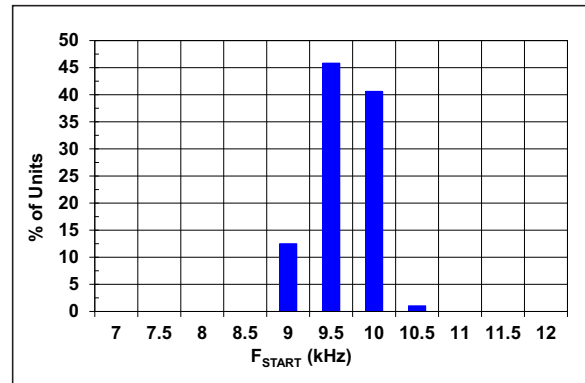

**FIGURE 2-6:** Startup Clock Frequency Histogram.

# HV98100/HV98101

---

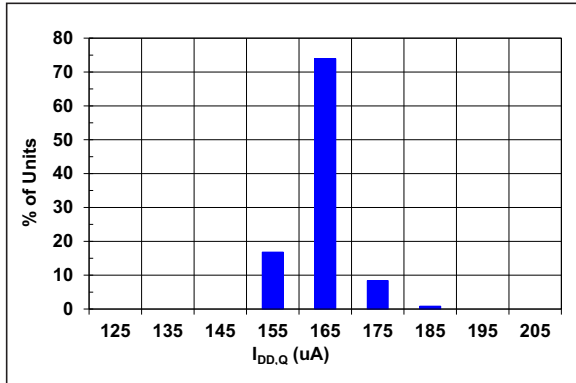

**FIGURE 2-7:** Quiescent Current Histogram.

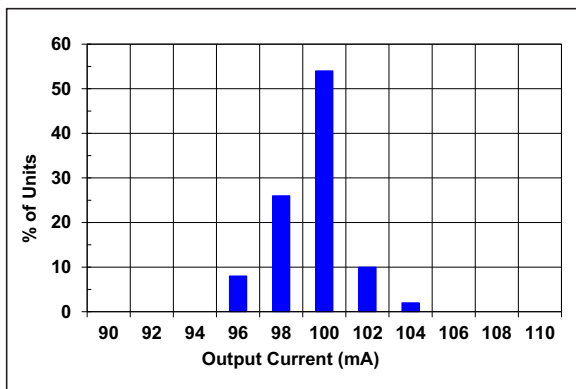

**FIGURE 2-8:** Output Current Accuracy in Application.

## 3.0 PIN DESCRIPTION

The description of the pins are listed in [Table 3-1](#).

**TABLE 3-1: PIN DESCRIPTION**

HV98100/HV98101 SOT-23	Symbol	Description
1	IND	Input from LED String Anode for both valley detection and over-voltage protection Pin
2	GND	Common connection for all circuits Pin
3	COMP	Loop compensation for stable response Pin
4	CS	Current sense input for sensing inductor current Pin
5	PV <sub>DD</sub>	Supply Voltage for the IC Pin
6	GATE	Gate driver for driving the external MOSFET Pin

### 3.1 IND

This pin is used for detecting the valley, as well as for over-voltage protection. The voltage at pin is maintained at approximately 4.3V. When the switching FET is off, current is sourced out of this pin. If this current exceeds 450  $\mu$ A, then over voltage is detected and the IC shuts down. This current sourced out of the pin is also used to detect the valley, using a patented method.

For proper operation, the IND pin should be shielded to prevent mis-triggering due to the large voltage slew rates present in application. A recommended layout is shown in [Figure 3-1](#).

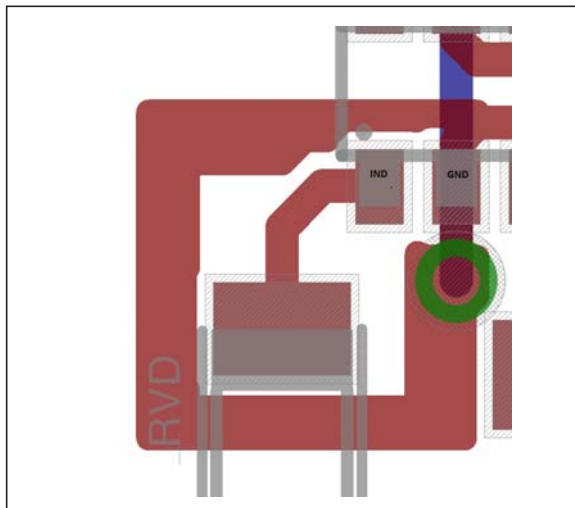

**FIGURE 3-1:** Shielding the IND Pin.

### 3.2 Power Ground Pin (GND)

This is the ground pin of the IC. The V<sub>DD</sub> capacitor and COMP network should be connected to this pin and the GND pin should be connected to the sense resistor, as shown in the [Typical Application Circuit](#) for proper functioning of the IC. [Figure 3-2](#) shows a recommended layout. Red traces in the layout are on the top layer, whereas blue traces on the layout are on the bottom layer.

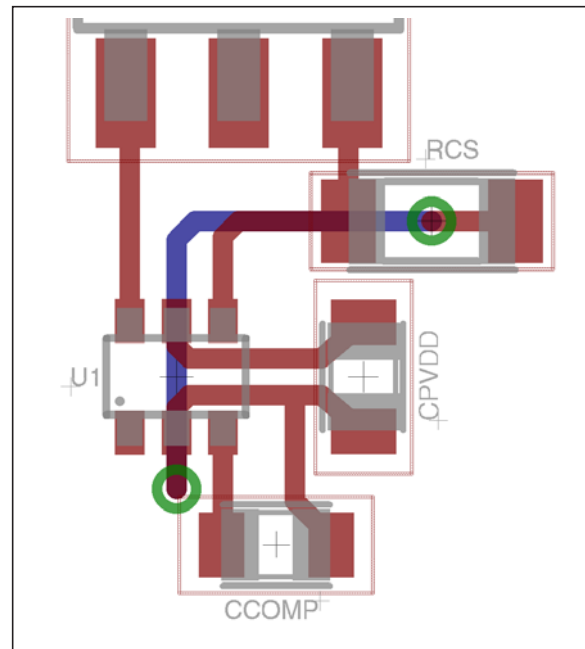

**FIGURE 3-2:** Connection to the GND Pin.

# HV98100/HV98101

---

## 3.3 COMP

This pin is the output of the internal transconductance amplifier. A compensation network connected between COMP and GND pins is used to stabilize the closed loop control of the LED current.

## 3.4 CS

This pin is used to sense the inductor current. The inductor current information is used to derive the output LED current, as well as to protect the inductor from saturation.

## 3.5 PV<sub>DD</sub>

This pin is the power supply pin for the IC. A minimum of 4.7  $\mu$ F capacitor needs to be connected between PV<sub>DD</sub> and GND for stability of the internal shunt regulator. The C<sub>PVDD</sub> capacitor needs to be placed physically close to the IC to minimize the trace length between the PV<sub>DD</sub> pin and the capacitor.

## 3.6 GATE

This pin is the gate drive output of the IC and is used to control the switching of the external FET.



## 4.0 FUNCTIONAL DESCRIPTION

### 4.1 Introduction

The HV98100/HV98101 control ICs provide constant average LED current for LED lamps and fixtures with a single-stage, valley-switching, buck-boost power-supply topology.

The IC is targeted at designs at a single-line voltage, such as 110 V<sub>AC</sub> (HV98100) or 230 V<sub>AC</sub> (HV98101) and does not support designs for universal input voltage range.

### 4.2 Principle of Operation

The IC adopts a novel control mechanism to vary both on-time and switching period at the same instant over the line cycle in a way that forces the average input current to be proportional to the input voltage, realizing high-power factor and low THD which is independent of the load voltage ( $V_O$ ) (unlike a constant on-time control where the THD is dependent on the LED string voltage).

In order to determine the LED current regulation, power balancing is used to maintain the mean programmable LED current ( $I_O$ ) in a closed-loop manner by means of the adaptive  $V_{COMP}$  swing upon the defined input/output voltage variation, as shown in [Equation 4-1](#).

#### EQUATION 4-1:

$$I_O = \frac{V_{in,rms}^2 \cdot K_T \cdot V_{COMP}}{V_O}$$

Assume a  $V_{COMP}$  variation from 1.2V to 3.8V, an input voltage ( $V_{IN,rms}$ ) variation of  $\pm 15\%$  and the internal timing constant ( $K_T$ ) variation of  $\pm 12\%$ . With these assumptions, the maximum variation in the LED string voltage (to maintain constant LED current) cannot exceed  $\pm 18\%$  approximately.

# HV98100/HV98101

## 5.0 APPLICATION INFORMATION

### 5.1 Introduction

This section describes the operation of the various blocks in the IC. Detailed design information, along with a design example, is provided in [Section 6.0 “Design Example”](#).

### 5.2 PV<sub>DD</sub> Regulator

The supply current is initially fed from the rectified AC input directly via an external start-up resistor ( $R_{HV}$ ) to peak charge a hold-up capacitor ( $C_{PVDD}$ ) connected at this pin. Note that a switching diode ( $D_{HV}$ ) is required in series to prevent the capacitor from discharging when the buck-boost converter FET ( $M_{BBT}$ ) turns on. As the voltage on the  $V_{DD}$  capacitor increases, the IC is held in a Stand-by mode and draws minimum current (200  $\mu$ A max.). Once the voltage at  $V_{DD}$  reaches  $V_{DD,ON}$ , the IC turns on and starts switching at an internally fixed switching frequency of 10 kHz, until the valley can be detected. Once the valley is detected, the converter starts working in the normal Valley-Switching mode and tries to regulate the LED current. In this mode, the current drawn by the IC from  $V_{DD}$  increases causing the voltage across the  $V_{DD}$  capacitor to start dropping (since the current supplied by the external start-up resistor is not sufficient).

If the  $V_{DD}$  voltage drops below  $V_{DD,OFF}$ , the IC enters into Stand-by mode and the process starts again. If the bootstrap from the output capacitor ( $C_O$ ) is available to prevent the  $V_{DD}$  voltage from going below  $V_{DD,OFF}$ , then the LED driver operates normally. In this way, as shown in [Figure 5-1](#), the  $PV_{DD}$  voltage bounces between  $V_{DD,ON}$  and  $V_{DD,OFF}$  within a hysteresis band for the IC to start GATE switching, until the energy stored in the output capacitor can be partially delivered to  $PV_{DD}$  through the bootstrapping resistor-diode network ( $R_{PVDD}$ - $D_{PVDD}$ ).

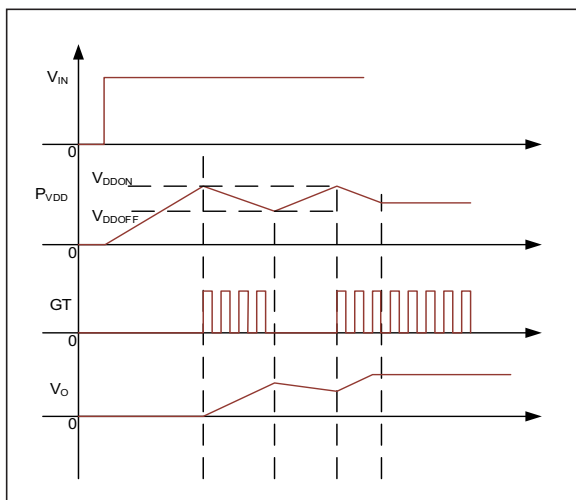

**FIGURE 5-1:** Typical Startup Waveforms.

The IC includes an internal  $V_{DD}$  clamp circuit. The clamp limits the voltage on the  $V_{DD}$  supply pin to the maximum value ( $PV_{DD,clamp}$ ). If the maximum current supplied through the external resistors minus the current consumption of the IC is lower than the maximum value that the Zener clamp can sustain ( $I_{DD,MAX}$ ), no external Zener diode is required.

### 5.3 LED Current Regulator

The LED current ( $I_O$ ) is sensed directly using an external sense resistor  $R_{CS}$  and compared to an internal fixed reference ( $CS_{REF}$ ). An internal transconductance amplifier is used to close the loop on the LED current with an external compensation capacitor. The LED current can be programmed as in [Equation 5-1](#).

#### EQUATION 5-1:

$$I_{LED} = \frac{CS_{REF}}{R_{CS}}$$

### 5.4 Valley Switching

The driver incorporates valley switching (quasi-resonant switching), a technique for reducing switching loss at the turn-on event of the buck-boost converter FET. Valley detect is accomplished by sensing the current sunk into the IND pin when the GATE is low. The operation is illustrated in [Figure 5-2](#). When the inductor current  $I_L$  has decreased to zero at  $t_2$ , the positive LED voltage  $V_L$  starts to oscillate around the 0V level (with respect to the IC GND), with an amplitude  $V_O$ . The GATE turns on again when the first lowest level (valley) is detected.

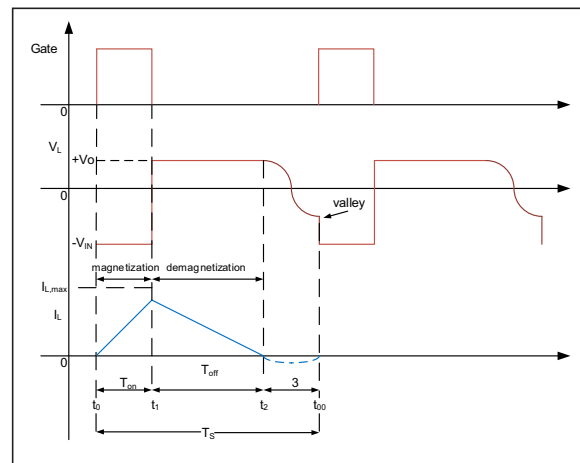

**FIGURE 5-2:** Valley Detect Waveforms.

However, in case the valley is not detected (during startup, output short circuit and input voltage zero crossings), a 10 kHz internal clock is used to start the next cycle.

## 5.5 Over-Voltage and Short-Circuit Protection

### 5.5.1 OVER-VOLTAGE PROTECTION

Apart from the valley detect, measuring the current sunk into the IND pin when the GATE is low can be used to sense an output over voltage or open circuit. The IND triggering level is  $I_{OVP}$ .

When the current into the IND pin exceeds  $I_{OVP}$ , the gate driver shuts down. The  $PV_{DD}$  capacitor starts discharging (since there is no bootstrap and the current through the input start-up resistor is insufficient to charge the capacitor). Once the voltage at  $PV_{DD}$  drops to  $V_{DD,OFF}$ , the IC goes into a low-current mode and the start-up procedure starts. This process keeps repeating until the over-voltage condition disappears.

### 5.5.2 SHORT-CIRCUIT PROTECTION

Output short circuit (or input under voltage) causes the converter to go into Continuous Conduction mode (CCM) by sensing the inductor current when  $M_{BBT}$  is on.

When the GATE turns on, a leading edge blanking circuit is activated within the IC. The blanking circuit has two functions:

1. Blank the first  $T_{BLNKOCP}$  of the GATE on-time. During this time,  $R_{CS}$  will detect the leading edge spike, and the edge spike is not allowed to propagate to the comparator since it might cause false triggering of the OCP comparator.
2. Allow the OCP comparator to see the next  $T_{DETOCP}$  of the inductor current. Since the converter is assumed to be in Boundary Conduction mode during normal operation, when the GATE turns on, the inductor current will start at zero and start ramping up. The IC compares the second voltage across  $R_{CS}$  in the detect window after the GATE turns on and determines if the converter is operating in CCM.

If the IC detects four consecutive cycles of CCM, the GATE is turned off and the IC goes through a POR.

Typical waveforms are shown in Figures 5-3 and 5-4.

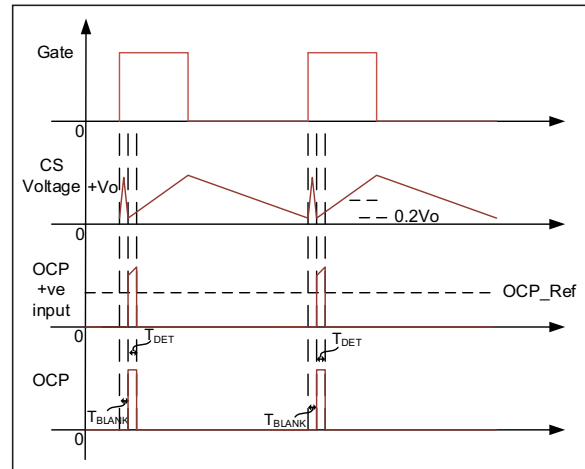

**FIGURE 5-3:** Waveforms During Normal Operation.

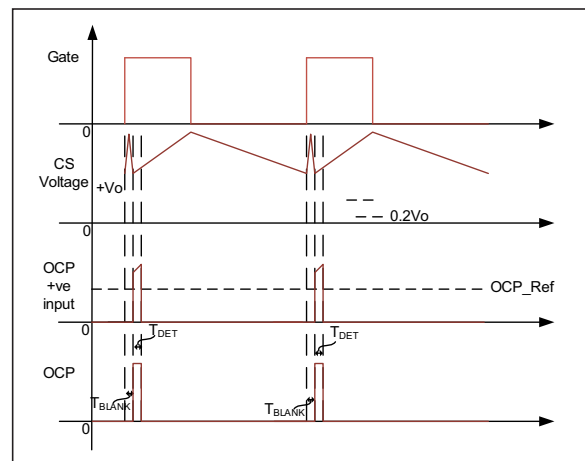

**FIGURE 5-4:** Waveforms During Short Circuit.

# HV98100/HV98101

## 6.0 DESIGN EXAMPLE

This section describes the procedure to design an HV98100/HV98101 LED driver. The specifications used for this example are:

- **Input:** 230 V<sub>AC</sub> r.m.s ±15%, 50 Hz
- **Output Current:** 150 mA
- **LED String Voltage:** 88V - 122V

### 6.1 Power stage design

#### 6.1.1 CALCULATING INPUT CURRENT

The maximum output power (P<sub>Omax</sub>) can be computed as:

##### EQUATION 6-1:

$$P_{O,max} = V_{O,max} \cdot I_O = 122V \cdot 150\text{ mA} = 18.3W$$

Assuming a sinusoidal input current wave-shape, the peak input current at the minimum input voltage and maximum output power can be computed to be:

##### EQUATION 6-2:

$$I_{IN,max,pk} = \frac{\sqrt{2} \cdot P_{O,max}}{V_{IN,min,rms} \cdot \eta} = \frac{\sqrt{2} \cdot 18.3W}{195.5V \cdot 0.85} = 156\text{ mA}$$

where:

η = the assumed efficiency of the converter

#### 6.1.2 SELECTING THE INDUCTOR

The typical inductor current waveform for a Boundary Conduction mode buck-boost converter is shown in [Figure 5-2](#). Ignoring the dead-time, the peak input current can be expressed as a function of the peak inductor current.

##### EQUATION 6-3:

$$I_{IN,max,peak} = \frac{1}{2} \cdot I_{L,max,pk} \cdot \frac{T_{ON,max}}{T_{S,max}}$$

Since a Boundary Conduction mode converter has the same DC transfer function as a Continuous Conduction mode (CCM) converter, the ratio of the on-time to the switching frequency can be expressed as:

##### EQUATION 6-4:

$$\frac{T_{ON,max}}{T_{S,max}} = \frac{I}{1 + \frac{\sqrt{2} \cdot V_{IN,min,rms}}{V_{O,max}}} = \frac{I}{1 + \frac{\sqrt{2} \cdot 195.5V}{122V}} = 0.31$$

Combining [Equations 6-2](#), [6-3](#) and [6-4](#):

##### EQUATION 6-5:

$$\begin{aligned} I_{L,max,pk} &= 2 \cdot I_{IN,max,peak} \cdot \frac{T_{S,max}}{T_{ON,max}} \\ &= 2 \cdot 156\text{ mA} \cdot \frac{1}{0.31} = 1A \end{aligned}$$

Assuming a minimum switching frequency of 30 kHz, the inductor value can be computed as:

##### EQUATION 6-6:

$$T_{ON,max} = \frac{T_{S,max}}{1 + \frac{\sqrt{2} \cdot V_{IN,min,rms}}{V_{O,max}}} = \frac{33.33\ \mu s}{1 + \frac{\sqrt{2} \cdot 195.5V}{122V}} = 10.2\ \mu s$$

##### EQUATION 6-7:

$$\begin{aligned} L_{BBT} &= \frac{\sqrt{2} \cdot V_{IN,min,rms} \cdot T_{ON,max}}{I_{L,max,pk}} \\ &= \frac{\sqrt{2} \cdot 195.5V \cdot 10.2\ \mu s}{1A} = 2.79\text{ mH} \end{aligned}$$

The inductor peak current has already been computed in [Equation 6-5](#). The r.m.s current can be computed using:

##### EQUATION 6-8:

$$\begin{aligned} K_{IL} &= \sqrt{\frac{(\sqrt{2} \cdot V_{IN,min,rms})^2}{8 \cdot V_{O,max}^2} + \frac{8 \cdot \sqrt{2} \cdot V_{IN,min,rms}}{9 \cdot \pi \cdot V_{O,max}} + \frac{1}{6}} \\ &= \sqrt{\frac{(\sqrt{2} \cdot 195.5V)^2}{8 \cdot 122V^2} + \frac{8 \cdot \sqrt{2} \cdot 195.5V}{9 \cdot \pi \cdot 122V} + \frac{1}{6}} \\ &= 1.204 \end{aligned}$$

**EQUATION 6-9:**

$$\begin{aligned}
 I_{L,rms} &= K_{IL} \cdot \frac{4 \cdot V_{O,max} \cdot I_O}{n \cdot \sqrt{2} \cdot V_{IN,min,rms}} \\
 &= 1.204 \cdot \frac{4 \cdot 122V \cdot 0.15A}{0.85 \cdot (\sqrt{2} \cdot 195.5V)} \\
 &= 0.375A
 \end{aligned}$$

**6.1.3 SELECTING THE SWITCHING FET**

The voltage rating of the switching FET should be:

**EQUATION 6-10:**

$$\begin{aligned}
 BV_{DSS,min} &= 1.3 \cdot (\sqrt{2} \cdot V_{IN,max,rms} + V_{O,max}) \\
 &= 1.3 \cdot (\sqrt{2} \cdot 264.5V + 122V) = 645V
 \end{aligned}$$

A 650V rated switching FET should be chosen for this application.

The r.m.s current through the FET is:

**EQUATION 6-11:**

$$\begin{aligned}
 I_{Q,rms,max} &= \\
 &\frac{4 \cdot V_{O,max} \cdot I_O}{n \cdot (\sqrt{2} \cdot V_{IN,min,rms})} \cdot \sqrt{\frac{1}{3} \cdot \left( \frac{4 \cdot (\sqrt{2} \cdot V_{IN,min,rms})}{3 \cdot \pi \cdot V_{O,max}} + \frac{1}{2} \right)} = \\
 &\frac{4 \cdot 122V \cdot 0.15A}{0.85 \cdot (\sqrt{2} \cdot 195.5)} \cdot \sqrt{\frac{1}{3} \cdot \left( \frac{4 \cdot (\sqrt{2} \cdot 195.5V)}{3 \cdot \pi \cdot 122V} + \frac{1}{2} \right)} \\
 &= 217.48 \text{ mA}
 \end{aligned}$$

The  $R_{ds,on}$  of the FET can be computed assuming a 3% power loss at maximum output power and minimum input voltage.

**EQUATION 6-12:**

$$R_{ds,on,25C} = \frac{0.03 \cdot P_{O,max}}{1.5 \cdot I_{Q,rms}^2} = \frac{0.03 \cdot 18.3W}{1.5 \cdot 0.217^2} = 7.77\Omega$$

The 1.5 factor in the denominator is used to account for the higher FET resistance in actual operation due to higher junction temperature.

**6.1.4 SELECTING THE SWITCHING DIODE**

The voltage rating of the switching diode should match or exceed the voltage rating of the switching FET. A high-speed diode with reverse recovery time in the order of 50 ns should be chosen for this application. The peak, r.m.s and average current through the diode can be computed using the following equations:

**EQUATION 6-13:**

$$I_{DBBT,avg} = I_O = 0.15A$$

**EQUATION 6-14:**

$$\begin{aligned}
 K_{ID} &= \sqrt{\frac{\sqrt{2} \cdot V_{IN,min,rms}}{3 \cdot V_{O,max}} \cdot \left( \frac{3 \cdot \sqrt{2} \cdot V_{IN,min,rms}}{8 \cdot V_{O,max}} + \frac{4}{3 \cdot \pi} \right)} \\
 &= \sqrt{\frac{\sqrt{2} \cdot 195.5V}{3 \cdot 122V} \cdot \left( \frac{3 \cdot (\sqrt{2} \cdot 195.5V)}{8 \cdot 122V} + \frac{4}{3 \cdot \pi} \right)} \\
 &= 0.981
 \end{aligned}$$

**EQUATION 6-15:**

$$\begin{aligned}
 I_{DBBT,max,rms} &= \frac{4 \cdot V_{O,max} \cdot I_O}{n \cdot \sqrt{2} \cdot V_{IN,min,rms}} \cdot K_{ID} \\
 &= \frac{4 \cdot 122V \cdot 0.15A}{0.85 \cdot \sqrt{2} \cdot 195.5V} \cdot 0.981 = 0.306A
 \end{aligned}$$

**EQUATION 6-16:**

$$I_{DBBT,peak} = I_{L,max,pk} = 1.0A$$

**6.1.5 CHOOSING THE OUTPUT CAPACITOR**

The output capacitor is chosen based on the maximum allowable line frequency ripple in the LED current. This can be computed if the desired flicker index is known.

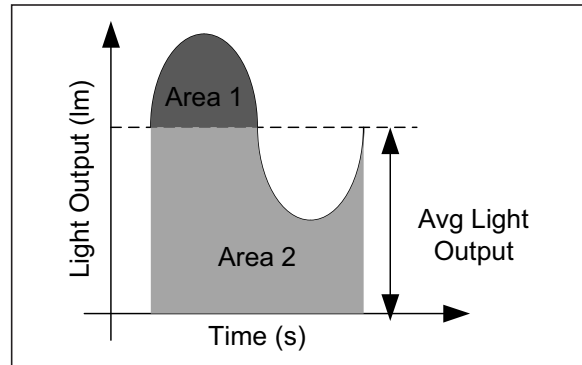

**FIGURE 6-1:** Flicker Index.

For a given instantaneous light output waveform (shown in Figure 6-1), the flicker index can be computed to be:

# HV98100/HV98101

## EQUATION 6-17:

$$FI = \frac{Area1}{(Area1) + (Area2)}$$

where:

- Area1 = the area of the curve above the average
- Area2 = the area of the curve below the average

Assuming that the instantaneous light output is directly proportional to the instantaneous LED current, the flicker index can be computed from the instantaneous LED current waveform shown in [Figure 6-1](#).

## EQUATION 6-18:

$$FI = \frac{\Delta I_O}{2 \cdot \pi \cdot I_O}$$

$$\Rightarrow \Delta I_O = 2 \cdot FI \cdot \pi \cdot I_O = 2 \cdot 0.15 \cdot \pi \cdot 0.15A = 0.14A$$

The typical LED string dynamic resistance can be computed as:

## EQUATION 6-19:

$$R_{LED} = 0.05 \cdot \frac{V_{O,max}}{I_O} = 0.05 \cdot \frac{122V}{0.15A} = 40.67\Omega$$

The corresponding line frequency peak-to-peak ripple in the output voltage is:

## EQUATION 6-20:

$$\Delta V_O = \Delta I_O \cdot R_{LED} = 0.14A \cdot 40.67\Omega = 5.69V$$

The output capacitor is usually dominated by the low-frequency ripple component. It can be computed using the following equation:

## EQUATION 6-21:

$$C_O = \frac{I_O}{4 \cdot \pi \cdot f_L \cdot \Delta V_O} = \frac{0.15A}{4 \cdot \pi \cdot 50Hz \cdot 5.69V} = 42\mu F$$

Voltage rating of the output capacitor should be about 20% higher than the maximum output voltage.

## EQUATION 6-22:

$$V_{CO} = 1.2 \cdot V_{O,max} = 1.2 \cdot 122V = 146V$$

The r.m.s current through the output capacitor is:

## EQUATION 6-23:

$$I_{Co,rms} = \sqrt{I_{DBBT,max,rms}^2 - I_O^2} = \sqrt{0.305A^2 - 0.15A^2} = 0.265A$$

### 6.1.6 SELECTING THE INPUT CAPACITOR

The input capacitor is selected to reduce the input ripple voltage. A simple first-pass selection can be computed as:

## EQUATION 6-24:

$$C_{REC} = \frac{0.5 \cdot I_{L,max,pk} \cdot T_{ON,max}}{0.1 \cdot \sqrt{2} \cdot V_{IN,min,rms}}$$

$$= \frac{0.5 \cdot 1A \cdot 10.2\mu s}{0.1 \cdot (\sqrt{2} \cdot 195.5V)} = 0.185\mu F$$

This capacitor will need to be adjusted in once a prototype is built. A large value will increase the THD where as a low value will affect the EMI performance.

## 6.2 Control Stage Design

### 6.2.1 SELECTING THE CURRENT SENSE RESISTOR

The current sense resistor value is set by the output current. The resistor's power rating is set by the inductor current.

## EQUATION 6-25:

$$R_{CS} = \frac{C_{S,REF}}{I_O} = \frac{0.2V}{0.15A} = 1.33\Omega$$

$$P_{Rcs} = I_{L,rms}^2 \cdot R_{CS} = 0.375A^2 \cdot 1.33\Omega = 0.187W$$

### 6.2.2 SELECTING THE VALLEY SENSE COMPONENTS

The resistor used for detecting the valley is also used for over-voltage protection. Hence, the resistor should be chosen based on the over-voltage setting desired.

Assume a 10% headroom over the maximum output voltage to set the minimum over-voltage threshold. Then, the resistor is:

## EQUATION 6-26:

$$R_{VD} = \frac{1.1 \cdot V_{O,max} - V_{IND}}{I_{OCP,min}} = \frac{1.1 \cdot 122V - 4.3V}{350\mu A} = 371k\Omega$$

Then maximum output voltage that can occur during over-voltage conditions is:

## EQUATION 6-27:

$$\begin{aligned} OVP_{max} &= I_{OCP,max} \cdot R_{VD} + V_{IND} = 550\mu A \cdot 371k\Omega + 4.3V \\ &= 208V \end{aligned}$$

Note that since this is not a continuous operation, the voltage rating of the output capacitor should be chosen to withstand this voltage, but not to operate at this voltage continuously.

The diode in series with this resistor should be a 500  $\mu$ A switching diode with a breakdown voltage of at least 400V (250V for a HV98100 design).

### 6.2.3 SELECTING THE START-UP NETWORK

The start-up resistor should be chosen based on the maximum start-up time that is allowable before the GATE starts switching. Note that selecting a shorter

start-up time will cause higher losses in the resistor during operation. The start-up time and power loss should be iterated until a reasonable compromise is achieved for both parameters.

The minimum capacitor at PV<sub>DD</sub> required is 4.7  $\mu$ F. In most cases this capacitor value is sufficient for hold-up.

Assuming a 100 ms start-up time ( $T_{STRT}$ ), the start-up resistor can be computed as shown in Equation 6-28.

## EQUATION 6-28:

$$\begin{aligned} R_{HV} &= \frac{\sqrt{2} \cdot V_{in,min,rms} - V_{DD,ON}}{C_{PVDD} \cdot V_{DD,ON} + 200\mu A} \cdot T_{STRT} = \frac{\sqrt{2} \cdot 195.5V - 16V}{\frac{4.7\mu F \cdot 16V}{100ms} + 200\mu A} \\ &= 273k\Omega \end{aligned}$$

The maximum power loss in the resistor occurs at high line and is shown in Equation 6-29.

## EQUATION 6-29:

$$\begin{aligned} P_{RHV,max} &= \frac{\sqrt{2} \cdot V_{in,max,rms} \cdot (4 \cdot V_{O,max} + \pi \cdot \sqrt{2} \cdot V_{in,max,rms})}{2 \cdot \pi \cdot R_{HV}} \\ &= \frac{\sqrt{2} \cdot 264.5V \cdot (4 \cdot 122V + \pi \cdot \sqrt{2} \cdot 264.5V)}{2 \cdot \pi \cdot 273k\Omega} = 0.363W \end{aligned}$$

The minimum average current supplied by RHV during operation is shown in Equation 6-30.

## EQUATION 6-30:

$$\begin{aligned} I_{RHV,min,avg} &= \frac{2 \cdot \sqrt{2} \cdot V_{in,min,rms}}{\pi \cdot R_{HV}} \\ &= \frac{2 \cdot \sqrt{2} \cdot 195.5V}{\pi \cdot 273k\Omega} \\ &= 645\mu A \end{aligned}$$

The diode in the start-up network ( $D_{HV}$ ) can be a simple 1N4148.

### 6.2.4 SELECTING BOOTSTRAP COMPONENTS

The total current required by the IC during normal operation comes from two sources

- Current through  $R_{HV}$
- Current through  $R_{PVDD}$

The current through  $R_{HV}$  resistor has been computed in Equation 6-28. The average current supplied through  $R_{PVDD}$  is:

## EQUATION 6-31:

$$I_{RPVDD,AVG} = \frac{1}{\pi} \cdot \int_0^{\pi} \left( \frac{V_O - PV_{DD}}{R_{PVDD}} \cdot \frac{\hat{V}_{IN} \cdot \sin\theta}{V_O + \hat{V}_{IN} \cdot \sin\theta} \right) d\theta$$

However, the closed form solution for the integral in Equation 6-31 is very complex. The equation can be simplified using a curve fit solution.

## EQUATION 6-32:

$$\begin{aligned} I_{RPVDD,AVG} &= \\ &= \frac{V_O - PV_{DD}}{R_{PVDD}} \cdot \left( 0.193 \cdot \ln\left(\frac{\hat{V}_{IN}}{V_O}\right) + 0.3801 \right) \end{aligned}$$

This approximation is valid as long as

$$2 \leq \frac{\hat{V}_{IN}}{V_O} \leq 10$$

# HV98100/HV98101

Assuming we need a total current of about 4 mA during normal operation, the  $R_{PVDD}$  resistor can be chosen as:

## EQUATION 6-33:

$$\begin{aligned}
 R_{PVDD} &= \\
 &= \frac{V_{O,min} - PV_{DD}}{(I_{PVDD} - I_{RHV})} \cdot \left( 0.193 \cdot \ln\left(\frac{\hat{V}_{IN}}{V_{O,min}}\right) + 0.3801 \right) \\
 &= \frac{88V - 16V}{(4mA - 645\mu A)} \cdot \left( 0.193 \cdot \ln\left(\frac{\sqrt{2} \cdot 195.5V}{88V}\right) + 0.3801 \right) \\
 &= 12k\Omega
 \end{aligned}$$

The power dissipated in the  $R_{PVDD}$  resistor can be computed as:

## EQUATION 6-34:

$$\begin{aligned}
 I_{RPVDD,rms} &= \frac{V_{O} - PV_{DD}}{R_{PVDD}} \cdot \sqrt{\left( 0.193 \cdot \ln\left(\frac{\hat{V}_{IN}}{V_{O}}\right) + 0.3801 \right)} \\
 &= \frac{88V - 16V}{12.9k\Omega} \cdot \sqrt{\left( 0.193 \cdot \ln\left(\frac{\sqrt{2} \cdot 195.5V}{88V}\right) + 0.3801 \right)} \\
 &= 4.33mA \\
 P_{RPVDD} &= I_{RPVDD,rms}^2 \cdot R_{PVDD} \\
 &= 4.33mA^2 \cdot 12.9k\Omega = 0.242W
 \end{aligned}$$

The average current drawn by the IC is not easy to estimate. It is recommended to start with an assumed higher value for the current consumed by the IC (4 mA-5 mA) and increase  $R_{PVDD}$  by trial and error.

The bootstrap diode should have a voltage rating of at least 400V (at least 250V for an HV98100 design) and an average current rating of about 5 mA. This should be a switching diode with a very low-junction capacitance (< 10 pF preferable).

## 6.2.5 CHOOSING THE COMPENSATION CAPACITOR

The compensation capacitor serves two functions in a power factor correction circuit:

- maintain loop stability
- reduce third harmonic distortion in the input current.

The capacitor can be chosen based on either criteria. For this design example, the capacitor is chosen based on the third harmonic distortion criterion. This criterion leads to a larger compensation capacitor value which also ensures stability in most cases.

The second harmonic component of the COMP voltage causes third harmonic distortion in the input current. The criterion used to design the compensation capacitor is that the second harmonic peak-to-peak voltage in COMP voltage is 2% of the DC component of the COMP voltage.

Equation 6-35 shows the relation between the input current and the DC component of the COMP voltage.

## EQUATION 6-35:

$$I_{IN,rms,max} = \frac{1}{2} \cdot \frac{V_{IN,rms,min}}{L} \cdot \frac{2 \cdot K_T \cdot COMP}{V_{TREF}}$$

Substituting values in Equation 6-35:

## EQUATION 6-36:

$$COMP = \frac{2 \cdot 2.79mH \cdot 110mA \cdot 2.5V}{2 \cdot 195.5V \cdot 1.25\mu s} = 3.14V$$

The compensation capacitor can be computed as:

## EQUATION 6-37:

$$\begin{aligned}
 C_{COMP} &= \frac{\Delta I_O \cdot R_{CS} \cdot g_m}{2 \cdot (2 \cdot \pi \cdot f_L) \cdot \Delta V_{COMP}} = \\
 &= \frac{0.14A \cdot 1.3\Omega \cdot 230\mu\frac{A}{V}}{2 \cdot (2 \cdot \pi \cdot 50Hz) \cdot 0.06V} = 1.11\mu F
 \end{aligned}$$

**Note:** The design of the EMI filter is beyond the scope of this design example. The design example is intended to provide a first pass design that can be further optimized in hardware.



## 7.0 PACKAGING INFORMATION

### 7.1 Package Marking Information

6-Lead, SOT-23  
(HV98100/HV98101)

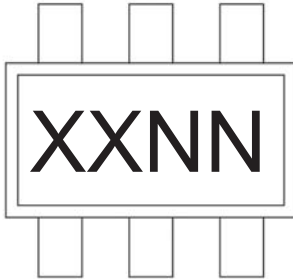

Product Number	Code
HV98100T-E/CH	S6NN
HV98101T-E/CH	S7NN

Example

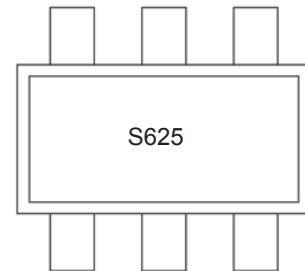

# HV98100/HV98101

## 6-Lead Plastic Small Outline Transistor (CH) [SOT-23]

**Note:** For the most current package drawings, please see the Microchip Packaging Specification located at <http://www.microchip.com/packaging>

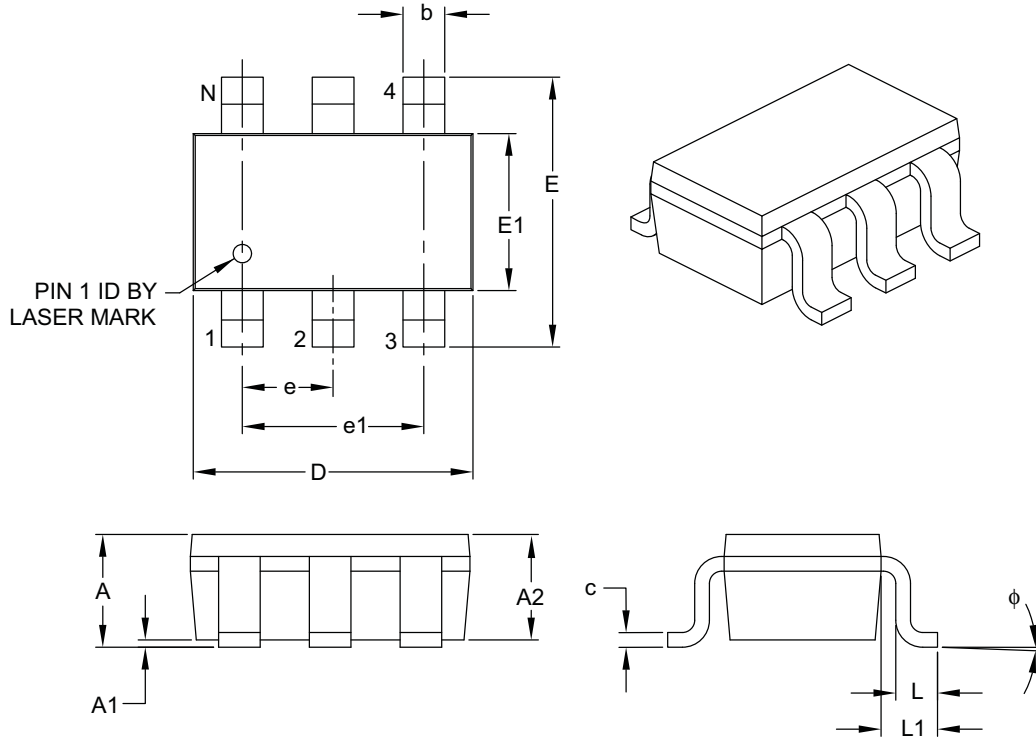

		Units	MILLIMETERS		
Dimension Limits			MIN	NOM	MAX
Number of Pins	N		6		
Pitch	e		0.95 BSC		
Outside Lead Pitch	e1		1.90 BSC		
Overall Height	A	0.90	–		1.45
Molded Package Thickness	A2	0.89	–		1.30
Standoff	A1	0.00	–		0.15
Overall Width	E	2.20	–		3.20
Molded Package Width	E1	1.30	–		1.80
Overall Length	D	2.70	–		3.10
Foot Length	L	0.10	–		0.60
Footprint	L1	0.35	–		0.80
Foot Angle	$\phi$	0°	–		30°
Lead Thickness	c	0.08	–		0.26
Lead Width	b	0.20	–		0.51

**Notes:**

- Dimensions D and E1 do not include mold flash or protrusions. Mold flash or protrusions shall not exceed 0.127 mm per side.
- Dimensioning and tolerancing per ASME Y14.5M.

BSC: Basic Dimension. Theoretically exact value shown without tolerances.

Microchip Technology Drawing C04-028B

## 6-Lead Plastic Small Outline Transistor (CH) [SOT-23]

**Note:** For the most current package drawings, please see the Microchip Packaging Specification located at <http://www.microchip.com/packaging>

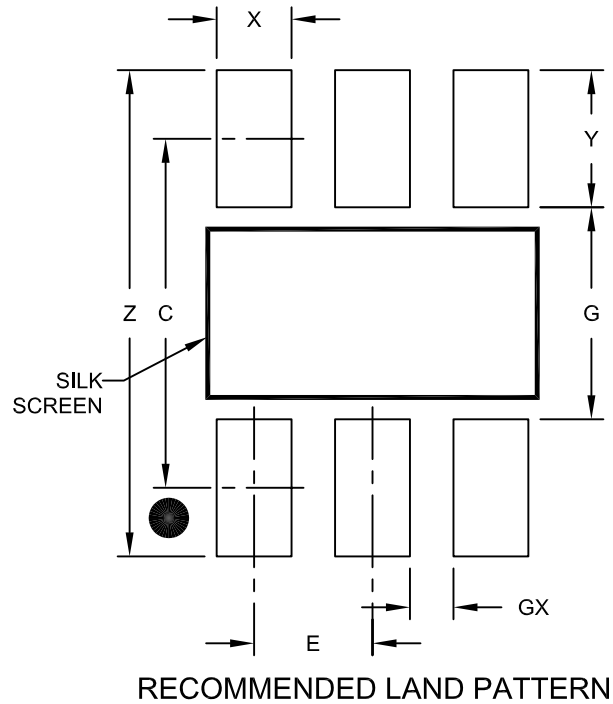

Dimension Limits	Units	MILLIMETERS		
		MIN	NOM	MAX
Contact Pitch	E	0.95 BSC		
Contact Pad Spacing	C	2.80		
Contact Pad Width (X6)	X			0.60
Contact Pad Length (X6)	Y			1.10
Distance Between Pads	G	1.70		
Distance Between Pads	GX	0.35		
Overall Width	Z			3.90

**Notes:**

1. Dimensioning and tolerancing per ASME Y14.5M

BSC: Basic Dimension. Theoretically exact value shown without tolerances.

Microchip Technology Drawing No. C04-2028A

# HV98100/HV98101

---

NOTES:

## APPENDIX A: REVISION HISTORY

### Revision A (October 2016)

- Original Release of this Document.

# HV98100/HV98101

---

NOTES:

## PRODUCT IDENTIFICATION SYSTEM

To order or obtain information, e.g., on pricing or delivery, refer to the factory or the listed sales office.

<u>PART NO.</u>	<u>[X]</u> <sup>(1)</sup>	<u>X</u>	<u>/XX</u>	
Device	Tape and Reel Option	Temperature Range	Package	
<b>Device:</b> HV98100= Off-line, high-power factor, buck-boost controller HV98101= Off-line, high-power factor, buck-boost controller				<b>Examples:</b> a) HV98100T-E/CH: Tape and Reel, Extended Temperature, 6LD SOT-23 package  b) HV98101T-E/CH: Tape and Reel, Extended Temperature, 6LD SOT-23 package  <b>Note 1:</b> Tape and Reel identifier only appears in the catalog part number description. This identifier is used for ordering purposes and is not printed on the device package. Check with your Microchip Sales Office for package availability with the Tape and Reel option.
<b>Tape and Reel Option:</b>	T = Tape and Reel <sup>(1)</sup>			
<b>Temperature Range:</b>	E = -40°C to +125°C(Extended)			
<b>Package:</b>	CH = Plastic Small Outline Transistor			

# HV98100/HV98101

---

NOTES:



---

**Note the following details of the code protection feature on Microchip devices:**

- Microchip products meet the specification contained in their particular Microchip Data Sheet.
- Microchip believes that its family of products is one of the most secure families of its kind on the market today, when used in the intended manner and under normal conditions.
- There are dishonest and possibly illegal methods used to breach the code protection feature. All of these methods, to our knowledge, require using the Microchip products in a manner outside the operating specifications contained in Microchip's Data Sheets. Most likely, the person doing so is engaged in theft of intellectual property.
- Microchip is willing to work with the customer who is concerned about the integrity of their code.
- Neither Microchip nor any other semiconductor manufacturer can guarantee the security of their code. Code protection does not mean that we are guaranteeing the product as “unbreakable.”

Code protection is constantly evolving. We at Microchip are committed to continuously improving the code protection features of our products. Attempts to break Microchip's code protection feature may be a violation of the Digital Millennium Copyright Act. If such acts allow unauthorized access to your software or other copyrighted work, you may have a right to sue for relief under that Act.

---

Information contained in this publication regarding device applications and the like is provided only for your convenience and may be superseded by updates. It is your responsibility to ensure that your application meets with your specifications. MICROCHIP MAKES NO REPRESENTATIONS OR WARRANTIES OF ANY KIND WHETHER EXPRESS OR IMPLIED, WRITTEN OR ORAL, STATUTORY OR OTHERWISE, RELATED TO THE INFORMATION, INCLUDING BUT NOT LIMITED TO ITS CONDITION, QUALITY, PERFORMANCE, MERCHANTABILITY OR FITNESS FOR PURPOSE. Microchip disclaims all liability arising from this information and its use. Use of Microchip devices in life support and/or safety applications is entirely at the buyer's risk, and the buyer agrees to defend, indemnify and hold harmless Microchip from any and all damages, claims, suits, or expenses resulting from such use. No licenses are conveyed, implicitly or otherwise, under any Microchip intellectual property rights unless otherwise stated.

*Microchip received ISO/TS-16949:2009 certification for its worldwide headquarters, design and wafer fabrication facilities in Chandler and Tempe, Arizona; Gresham, Oregon and design centers in California and India. The Company's quality system processes and procedures are for its PIC® MCUs and dsPIC® DSCs, KEELoq® code hopping devices, Serial EEPROMs, microperipherals, nonvolatile memory and analog products. In addition, Microchip's quality system for the design and manufacture of development systems is ISO 9001:2000 certified.*

**QUALITY MANAGEMENT SYSTEM  
CERTIFIED BY DNV  
= ISO/TS 16949 =**

### Trademarks

The Microchip name and logo, the Microchip logo, AnyRate, dsPIC, FlashFlex, flexPWR, Heldo, JukeBlox, KeeLoq, KeeLoq logo, Klear, LANCheck, LINK MD, MediaLB, MOST, MOST logo, MPLAB, OptoLyzer, PIC, PICSTART, PIC32 logo, RightTouch, SpyNIC, SST, SST Logo, SuperFlash and UNI/O are registered trademarks of Microchip Technology Incorporated in the U.S.A. and other countries.

ClockWorks, The Embedded Control Solutions Company, ETHERSYNCH, Hyper Speed Control, HyperLight Load, IntelliMOS, mTouch, Precision Edge, and QUIET-WIRE are registered trademarks of Microchip Technology Incorporated in the U.S.A.

Analog-for-the-Digital Age, Any Capacitor, AnyIn, AnyOut, BodyCom, chipKIT, chipKIT logo, CodeGuard, dsPICDEM, dsPICDEM.net, Dynamic Average Matching, DAM, ECAN, EtherGREEN, In-Circuit Serial Programming, ICSP, Inter-Chip Connectivity, JitterBlocker, KlearNet, KlearNet logo, MiWi, motorBench, MPASM, MPF, MPLAB Certified logo, MPLIB, MPLINK, MultiTRAK, NetDetach, Omniscient Code Generation, PICDEM, PICDEM.net, PICkit, PICtail, PureSilicon, RightTouch logo, REAL ICE, Ripple Blocker, Serial Quad I/O, SQL, SuperSwitcher, SuperSwitcher II, Total Endurance, TSHARC, USBCheck, VariSense, ViewSpan, WiperLock, Wireless DNA, and ZENA are trademarks of Microchip Technology Incorporated in the U.S.A. and other countries.

SQTP is a service mark of Microchip Technology Incorporated in the U.S.A.

Silicon Storage Technology is a registered trademark of Microchip Technology Inc. in other countries.

GestIC is a registered trademarks of Microchip Technology Germany II GmbH & Co. KG, a subsidiary of Microchip Technology Inc., in other countries.

All other trademarks mentioned herein are property of their respective companies.

© 2016, Microchip Technology Incorporated, Printed in the U.S.A., All Rights Reserved.

ISBN: 978-1-5224-1046-1



# MICROCHIP

## Worldwide Sales and Service

### AMERICAS

**Corporate Office**  
2355 West Chandler Blvd.  
Chandler, AZ 85224-6199  
Tel: 480-792-7200  
Fax: 480-792-7277  
Technical Support:  
<http://www.microchip.com/support>  
Web Address:  
[www.microchip.com](http://www.microchip.com)

**Atlanta**  
Duluth, GA  
Tel: 678-957-9614  
Fax: 678-957-1455

**Austin, TX**  
Tel: 512-257-3370

**Boston**  
Westborough, MA  
Tel: 774-760-0087  
Fax: 774-760-0088

**Chicago**  
Itasca, IL  
Tel: 630-285-0071  
Fax: 630-285-0075

**Cleveland**  
Independence, OH  
Tel: 216-447-0464  
Fax: 216-447-0643

**Dallas**  
Addison, TX  
Tel: 972-818-7423  
Fax: 972-818-2924

**Detroit**  
Novi, MI  
Tel: 248-848-4000

**Houston, TX**  
Tel: 281-894-5983

**Indianapolis**  
Noblesville, IN  
Tel: 317-773-8323  
Fax: 317-773-5453

**Los Angeles**  
Mission Viejo, CA  
Tel: 949-462-9523  
Fax: 949-462-9608

**New York, NY**  
Tel: 631-435-6000

**San Jose, CA**  
Tel: 408-735-9110

**Canada - Toronto**  
Tel: 905-695-1980  
Fax: 905-695-2078

### ASIA/PACIFIC

**Asia Pacific Office**  
Suites 3707-14, 37th Floor  
Tower 6, The Gateway  
Harbour City, Kowloon

**Hong Kong**  
Tel: 852-2943-5100  
Fax: 852-2401-3431

**Australia - Sydney**  
Tel: 61-2-9868-6733  
Fax: 61-2-9868-6755

**China - Beijing**  
Tel: 86-10-8569-7000  
Fax: 86-10-8528-2104

**China - Chengdu**  
Tel: 86-28-8665-5511  
Fax: 86-28-8665-7889

**China - Chongqing**  
Tel: 86-23-8980-9588  
Fax: 86-23-8980-9500

**China - Dongguan**  
Tel: 86-769-8702-9880

**China - Guangzhou**  
Tel: 86-20-8755-8029

**China - Hangzhou**  
Tel: 86-571-8792-8115  
Fax: 86-571-8792-8116

**China - Hong Kong SAR**  
Tel: 852-2943-5100  
Fax: 852-2401-3431

**China - Nanjing**  
Tel: 86-25-8473-2460  
Fax: 86-25-8473-2470

**China - Qingdao**  
Tel: 86-532-8502-7355  
Fax: 86-532-8502-7205

**China - Shanghai**  
Tel: 86-21-5407-5533  
Fax: 86-21-5407-5066

**China - Shenyang**  
Tel: 86-24-2334-2829  
Fax: 86-24-2334-2393

**China - Shenzhen**  
Tel: 86-755-8864-2200  
Fax: 86-755-8203-1760

**China - Wuhan**  
Tel: 86-27-5980-5300  
Fax: 86-27-5980-5118

**China - Xian**  
Tel: 86-29-8833-7252  
Fax: 86-29-8833-7256

### ASIA/PACIFIC

**China - Xiamen**  
Tel: 86-592-2388138  
Fax: 86-592-2388130

**China - Zhuhai**  
Tel: 86-756-3210040  
Fax: 86-756-3210049

**India - Bangalore**  
Tel: 91-80-3090-4444  
Fax: 91-80-3090-4123

**India - New Delhi**  
Tel: 91-11-4160-8631  
Fax: 91-11-4160-8632

**India - Pune**  
Tel: 91-20-3019-1500

**Japan - Osaka**  
Tel: 81-6-6152-7160  
Fax: 81-6-6152-9310

**Japan - Tokyo**  
Tel: 81-3-6880-3770  
Fax: 81-3-6880-3771

**Korea - Daegu**  
Tel: 82-53-744-4301  
Fax: 82-53-744-4302

**Korea - Seoul**  
Tel: 82-2-554-7200  
Fax: 82-2-558-5932 or  
82-2-558-5934

**Malaysia - Kuala Lumpur**  
Tel: 60-3-6201-9857  
Fax: 60-3-6201-9859

**Malaysia - Penang**  
Tel: 60-4-227-8870  
Fax: 60-4-227-4068

**Philippines - Manila**  
Tel: 63-2-634-9065  
Fax: 63-2-634-9069

**Singapore**  
Tel: 65-6334-8870  
Fax: 65-6334-8850

**Taiwan - Hsin Chu**  
Tel: 886-3-5778-366  
Fax: 886-3-5770-955

**Taiwan - Kaohsiung**  
Tel: 886-7-213-7828

**Taiwan - Taipei**  
Tel: 886-2-2508-8600  
Fax: 886-2-2508-0102

**Thailand - Bangkok**  
Tel: 66-2-694-1351  
Fax: 66-2-694-1350

### EUROPE

**Austria - Wels**  
Tel: 43-7242-2244-39  
Fax: 43-7242-2244-393

**Denmark - Copenhagen**  
Tel: 45-4450-2828  
Fax: 45-4485-2829

**France - Paris**  
Tel: 33-1-69-53-63-20  
Fax: 33-1-69-30-90-79

**Germany - Dusseldorf**  
Tel: 49-2129-3766400

**Germany - Karlsruhe**  
Tel: 49-721-625370

**Germany - Munich**  
Tel: 49-89-627-144-0  
Fax: 49-89-627-144-44

**Italy - Milan**  
Tel: 39-0331-742611  
Fax: 39-0331-466781

**Italy - Venice**  
Tel: 39-049-7625286

**Netherlands - Drunen**  
Tel: 31-416-690399  
Fax: 31-416-690340

**Poland - Warsaw**  
Tel: 48-22-3325737

**Spain - Madrid**  
Tel: 34-91-708-08-90  
Fax: 34-91-708-08-91

**Sweden - Stockholm**  
Tel: 46-8-5090-4654

**UK - Wokingham**  
Tel: 44-118-921-5800  
Fax: 44-118-921-5820

06/23/16