

Part Number: APHB1608LSYKSURKC

Super Bright Yellow
Hyper Red

Features

- 1.6mmX0.8mm SMD LED, 0.5mm thickness.
- Compatible with reflow soldering.
- Available in various color combination.
- Package: 2000pcs / reel .
- Moisture sensitivity level : level 3.
- Tinned pads for improved solderability.
- Low current IF=2mA operating.
- RoHS compliant.

Descriptions

- The Super Bright Yellow device is made with AlGaInP (on GaAs substrate) light emitting diode chip.
- The Hyper Red source color devices are made with Al GaInP on GaAs substrate Light Emitting Diode.

Package Dimensions

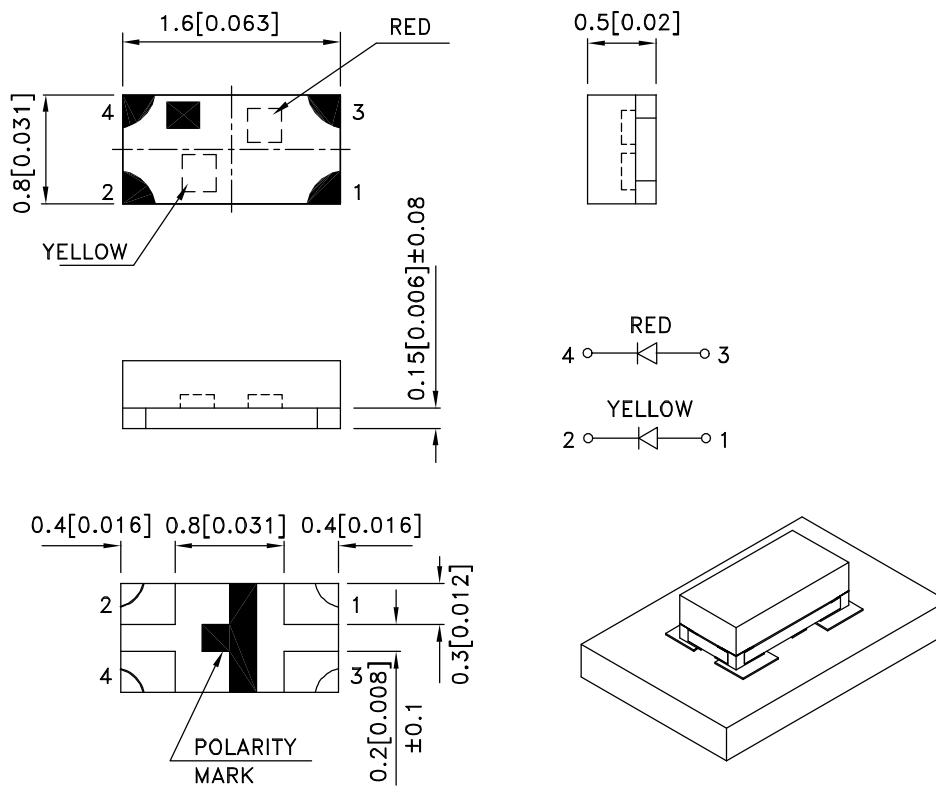

Notes:

1. All dimensions are in millimeters (inches).
2. Tolerance is $\pm 0.15(0.006)$ unless otherwise noted.
3. The specifications, characteristics and technical data described in the datasheet are subject to change without prior notice.
4. The device has a single mounting surface. The device must be mounted according to the specifications.



Selection Guide

Part No.	Emitting Color (Material)	Lens Type	Iv (mcd) [2] @ 2mA		Viewing Angle [1]
			Min.	Typ.	2θ1/2
APHB1608LSYKSURKC	Super Bright Yellow (AlGaInP)	Water Clear	6	10	130°
			*6	*10	
	Hyper Red (AlGaInP)		10	20	
			*2	*8	

Notes:

1. θ1/2 is the angle from optical centerline where the luminous intensity is 1/2 of the optical peak value.
2. Luminous intensity/ luminous Flux: +/-15%.
- * Luminous intensity value is traceable to the CIE127-2007 compliant national standards.

Electrical / Optical Characteristics at TA=25°C

Symbol	Parameter	Emitting Color	Min.	Typ.	Max.	Units	Test Conditions
λpeak	Peak Wavelength	Super Bright Yellow Hyper Red		590 645		nm	If=2mA
λD [1]	Dominant Wavelength	Super Bright Yellow Hyper Red		590 630		nm	If=2mA
Δλ1/2	Spectral Line Half-width	Super Bright Yellow Hyper Red		20 28		nm	If=2mA
C	Capacitance	Super Bright Yellow Hyper Red		20 35		pF	Vf=0V;f=1MHz
Vf [2]	Forward Voltage	Super Bright Yellow Hyper Red	1.5 1.5	1.85 1.75	2.1 2.1	V	If=2mA
IR	Reverse Current	Super Bright Yellow Hyper Red			10 10	uA	VR = 5V

Notes:

1. Wavelength: +/-1nm.
2. Forward Voltage: +/-0.1V.
3. Wavelength value is traceable to the CIE127-2007 compliant national standards.
4. Excess driving current and/or operating temperature higher than recommended conditions may result in severe light degradation or premature failure.

Absolute Maximum Ratings at TA=25°C

Parameter	Super Bright Yellow	Hyper Red	Units
Power dissipation	63	63	mW
DC Forward Current	30	30	mA
Peak Forward Current [1]	175	185	mA
Reverse Voltage	5		V
Operating Temperature	-40°C To +85°C		
Storage Temperature	-40°C To +85°C		

Note:

1. 1/10 Duty Cycle, 0.1ms Pulse Width.

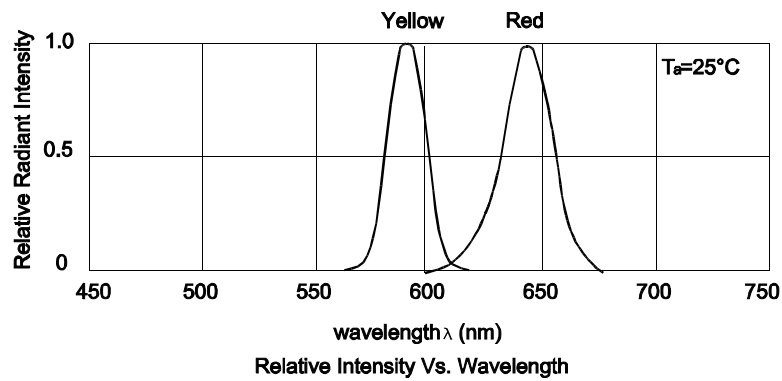

APHB1608LSYKSURKC Super Bright Yellow

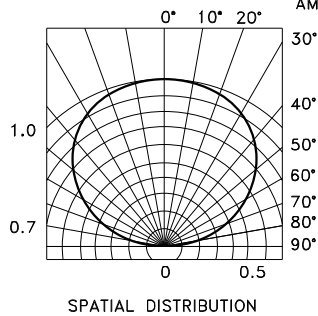
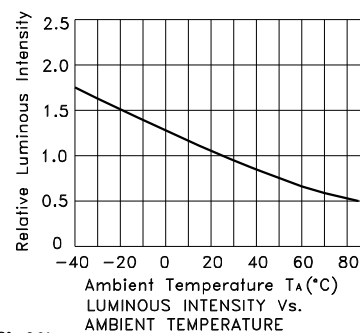
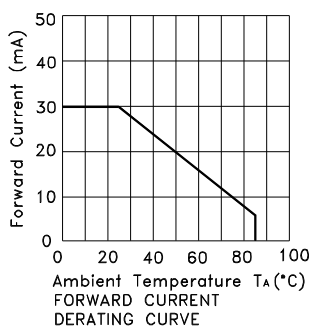
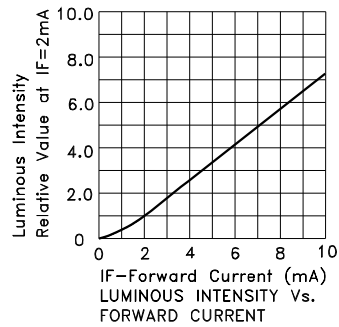
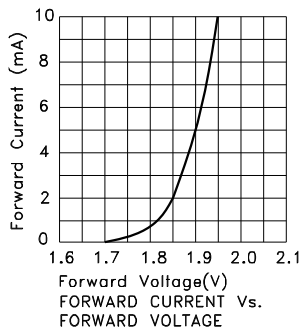

Kingbright

Hyper Red

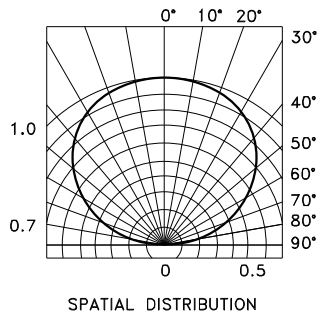
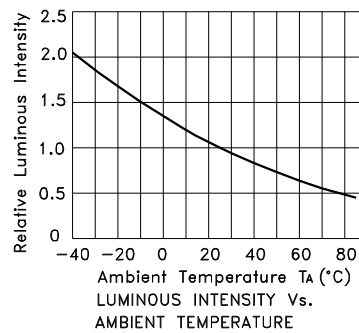
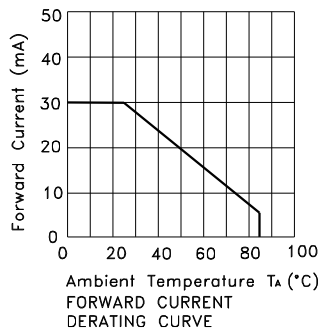
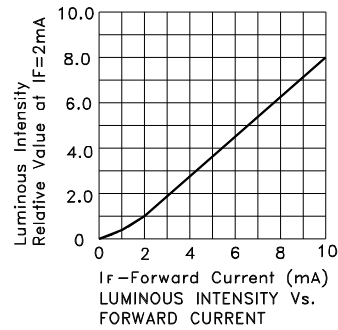
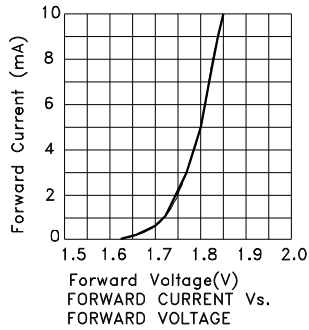

APHB1608LSYKSURKC

Reflow soldering is recommended and the soldering profile is shown below.
Other soldering methods are not recommended as they might cause damage to the product.

Reflow Soldering Profile For Lead-free SMT Process.



NOTES:

1. We recommend the reflow temperature 245°C(+/-5°C). The maximum soldering temperature should be limited to 260°C.
2. Don't cause stress to the epoxy resin while it is exposed to high temperature.
3. Number of reflow process shall be 2 times or less.

Recommended Soldering Pattern (Units : mm; Tolerance: ± 0.1)

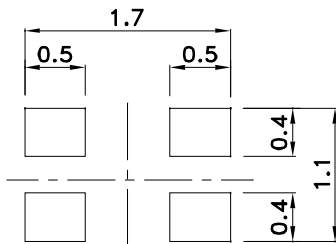

Reel Dimension



Tape Dimensions (Units : mm)

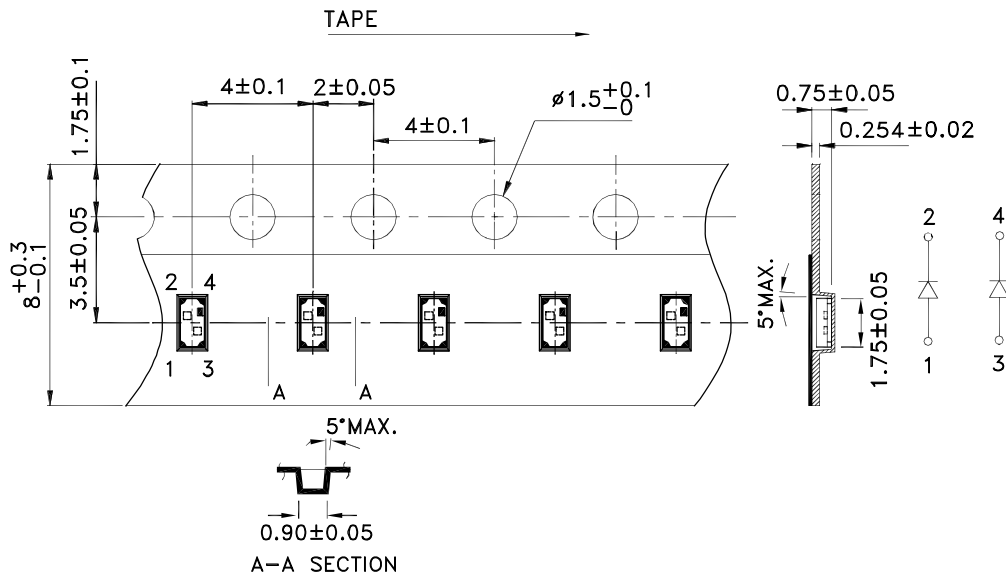

PACKING & LABEL SPECIFICATIONS

APHB1608LSYKSURKC

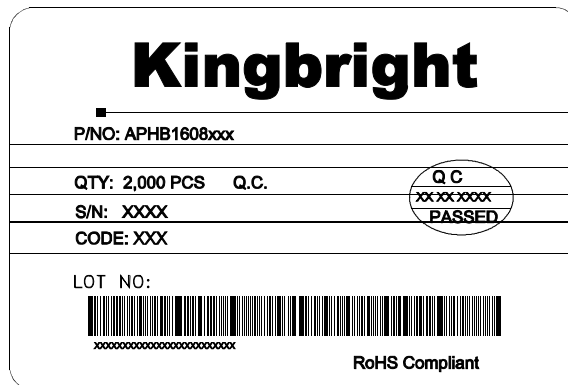
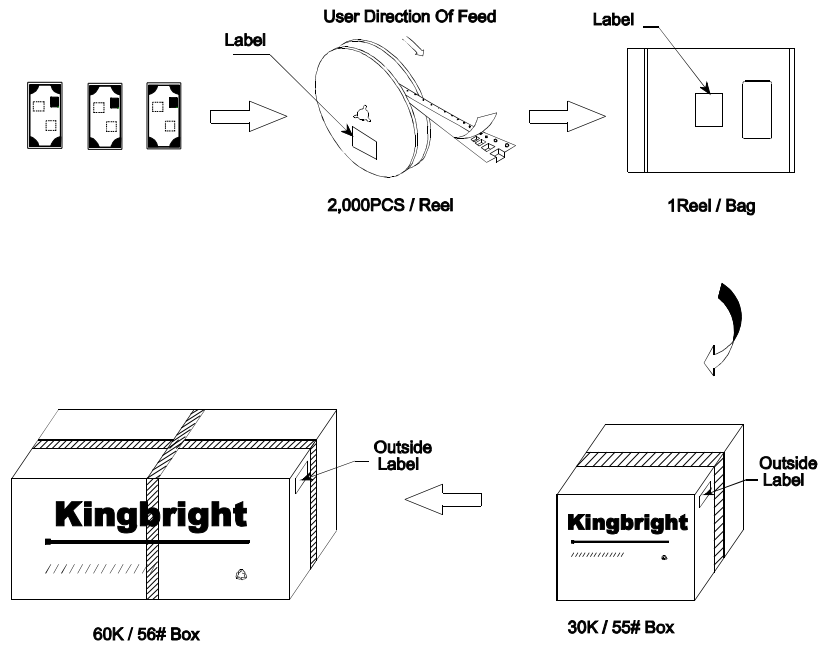

Terms and conditions for the usage of this document

1. The information included in this document reflects representative usage scenarios and is intended for technical reference only.
2. The part number, type, and specifications mentioned in this document are subject to future change and improvement without notice. Before production usage customer should refer to the latest datasheet for the updated specifications.
3. When using the products referenced in this document, please make sure the product is being operated within the environmental and electrical limits specified in the datasheet. If customer usage exceeds the specified limits, Kingbright will not be responsible for any subsequent issues.
4. The information in this document applies to typical usage in consumer electronics applications. If customer's application has special reliability requirements or have life-threatening liabilities, such as automotive or medical usage, please consult with Kingbright representative for further assistance.
5. The contents and information of this document may not be reproduced or re-transmitted without permission by Kingbright.
6. All design applications should refer to Kingbright application notes available at <http://www.KingbrightUSA.com/ApplicationNotes>