

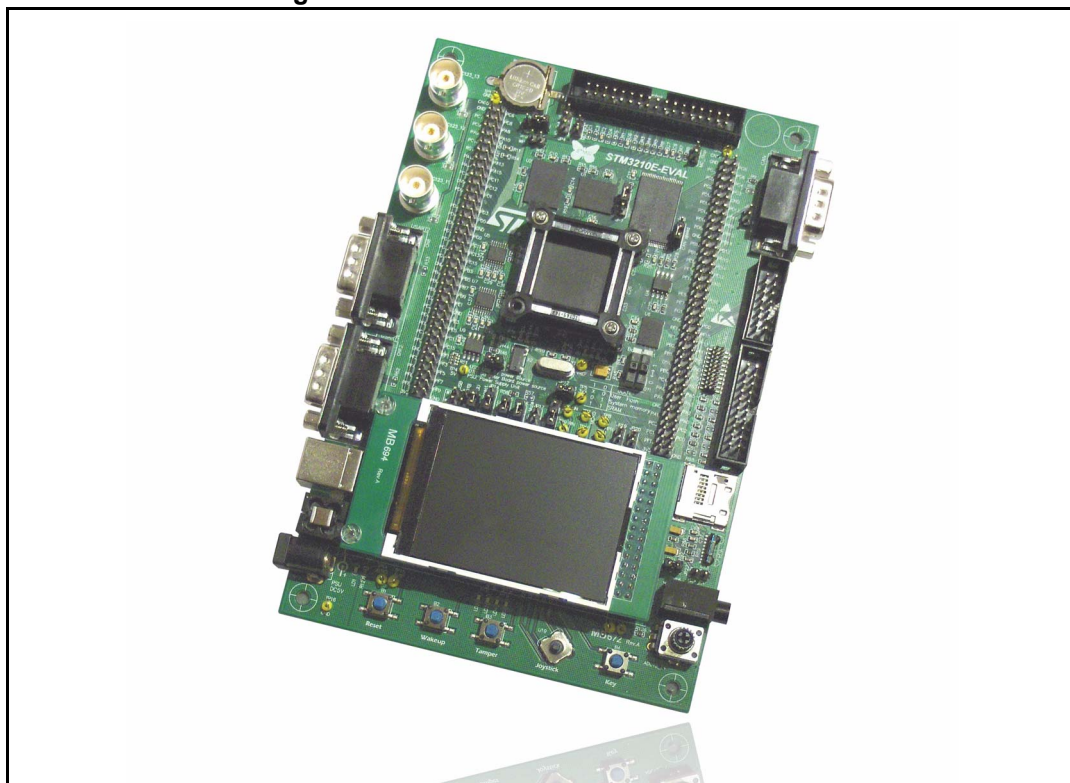
Introduction

The STM3210E-EVAL evaluation board is designed as a complete development platform for STMicroelectronics' ARM Cortex-M3 core-based STM32F103ZGT6 microcontroller with full speed USB2.0, CAN2.0A/B compliant interface, two I2S channels, two I2C channels, five USART channels with smartcard support, three SPI channels, two DAC channels, FSMC interface, SDIO, internal 96 KB SRAM and 1 MB Flash, JTAG and SWD debug support.

The STM3210E-EVAL products delivered with the MB672 board versions D-03 or older are based on the STM32F103ZET6 instead of the STM32F103ZGT6 and include 64 KB internal SRAM and 512 KB Flash. The board number and version are on a label on the bottom side of the board.

The full range of hardware features on the board helps you to evaluate all peripherals (USB, motor control, CAN, MicroSD Card, smartcard, USART, NOR Flash, NAND Flash, SRAM) and develop your own applications. Extension headers make it easy to connect a daughterboard or wrapping board for your specific application.

Figure 1. STM3210E-EVAL evaluation board



Contents

1	Overview	6
1.1	Order code	6
1.2	Features	6
1.3	Demonstration software	6
2	Hardware layout and configuration	7
2.1	Power supply	9
2.2	Boot option	10
2.3	Clock source	10
2.4	Reset source	10
2.5	Audio	11
2.6	Serial Flash	11
2.7	CAN	11
2.8	RS-232 connectors	12
2.9	Motor control	12
2.10	Smartcard	13
2.11	MicroSD Card	13
2.12	Temperature sensor	14
2.13	Analog input	14
2.14	IrDA	14
2.15	USB	14
2.16	Development and debug support	15
2.17	Display and input devices	15
2.18	SRAM	16
2.19	NAND Flash	16
2.20	NOR Flash	17
3	Connectors	18
3.1	Motor control connector CN1	18
3.2	Analog input connectors CN2, CN3 and CN5	19
3.3	CAN D-type 9-pin male connector CN4	19

3.4	QST connector CN6	19
3.5	Trace debugging connector CN7	20
3.6	RS-232 connector CN8 with RTS/CTS handshake support	21
3.7	JTAG debugging connector CN9	21
3.8	Daughterboard extension connectors CN10 and CN11	22
3.9	RS-232 connector CN12	28
3.10	MicroSD Card connector CN13	28
3.11	USB type B connector CN14	29
3.12	Audio jack CN15	29
3.13	TFT LCD connector CN16	29
3.14	Power connector CN17	29
3.15	Smartcard connector CN18	30
4	Schematic diagrams	31
	Appendix A STM3210E-EVAL I/O assignment	44
	Revision history	49

List of tables

Table 1.	Power related jumpers	9
Table 2.	Boot related switches	10
Table 3.	Reset related jumper	10
Table 4.	Audio related jumpers	11
Table 5.	CAN related jumpers	11
Table 6.	Motor control related jumpers	12
Table 7.	Connection between ST8024 and STM32F103ZGT6	13
Table 8.	Smartcard related jumpers	13
Table 9.	MicroSD Card related jumpers	14
Table 10.	IrDA related jumpers	14
Table 11.	USB related jumpers	15
Table 12.	LCD modules	15
Table 13.	NAND Flash related jumpers	17
Table 14.	NOR Flash related jumpers	17
Table 15.	NOR Flash reference	17
Table 16.	Motor control connector CN1	18
Table 17.	Analog input connector CN2, CN3 and CN5	19
Table 18.	CAN D-type 9-pins male connector CN4	19
Table 19.	QST connector CN6	20
Table 20.	Trace debugging connector CN7	20
Table 21.	RS-232 connector CN8 with RTS/CTS handshake support	21
Table 22.	JTAG debugging connector CN9	21
Table 23.	Daughterboard extension connector CN10	22
Table 24.	Daughterboard extension connector CN11	25
Table 25.	RS-232 connector CN12	28
Table 26.	MicroSD Card connector CN13	28
Table 27.	USB type B connector CN14	29
Table 28.	Smartcard connector CN18	30
Table 29.	STM3210E-EVAL I/O assignment	44
Table 30.	Document revision history	49

List of figures

Figure 1.	STM3210E-EVAL evaluation board	1
Figure 2.	Hardware block diagram	7
Figure 3.	STM3210E-EVAL evaluation board layout	8
Figure 4.	Motor control connector CN1 (top view)	18
Figure 5.	Analog input connector CN2, CN3 and CN5 bottom view	19
Figure 6.	CAN D-type 9-pin male connector CN4 (front view)	19
Figure 7.	QST connector CN6 (front view)	19
Figure 8.	Trace debugging connector CN7 (top view)	20
Figure 9.	RS-232 connector CN8 with RTS/CTS handshake support (front view)	21
Figure 10.	JTAG debugging connector CN9 (top view)	21
Figure 11.	RS-232 connector CN12 (front view)	28
Figure 12.	MicroSD Card connector CN13 (front view)	28
Figure 13.	USB type B connector CN14 (top view)	29
Figure 14.	Power supply connector CN17 (front view)	29
Figure 15.	Smartcard connector CN18 (front view)	30
Figure 16.	Microcontroller	32
Figure 17.	MCU	33
Figure 18.	Peripherals	34
Figure 19.	RS-232 and IrDA	35
Figure 20.	Audio	36
Figure 21.	LCD and joystick	37
Figure 22.	SD Card and smartcard	38
Figure 23.	Motor control	39
Figure 24.	JTAG and trace connectors	40
Figure 25.	Power supply	41
Figure 26.	SRAM and Flash	42
Figure 27.	Color LCD module	43

1 Overview

1.1 Order code

To order the STM32F103ZGT6GT6 evaluation board, use the order code STM3210E-EVAL.

1.2 Features

- Three 5 V power supply options: power jack, USB connector or daughterboard
- Boot from user Flash, system memory or SRAM
- I2S audio DAC, stereo audio jack
- 128 Mbyte MicroSD Card™
- Both A and B type smartcard support
- 64 or 128 Mbit serial Flash, 512 Kx16 SRAM, 512 Mbit or 1 Gbit NAND Flash and 128 Mbit NOR Flash
- I2C/SMBus compatible serial interface temperature sensor
- Two RS-232 channels with RTS/CTS handshake support on one channel
- IrDA transceiver
- USB2.0 full speed connection
- CAN2.0A/B compliant connection
- Inductor motor control connector
- JTAG and trace debug support
- 240x320 TFT color LCD
- Joystick with 4-direction control and selector
- Reset, wakeup, tamper and user buttons
- 4 color LEDs
- RTC with backup battery

1.3 Demonstration software

Demonstration software is preloaded in board's Flash memory for easy demonstration of the device peripherals in stand-alone mode. For more information and to download the latest version available, please refer to the STM3210E-EVAL demonstration software available from www.st.com

To use the STM3210E-EVAL evaluation board, you must have the demonstration software version 1.1 or later. If the version installed on your evaluation board is earlier than version 1.1, you must download the latest version from www.st.com.

2 Hardware layout and configuration

The STM3210E-EVAL evaluation board is designed around the **STM32F103ZGT6** microcontroller in a 144-pin TQFP package. The hardware block diagram [Figure 2](#) illustrates the connections between the STM32F103ZGT6 and peripherals (LCD, SPI Flash, USART, IrDA, USB, audio, CAN bus, smartcard, MicroSD Card, NOR Flash, NAND Flash, SRAM, temperature sensor, audio DAC and motor control) and [Figure 3](#) helps you to locate these features on the actual evaluation board.

Figure 2. Hardware block diagram

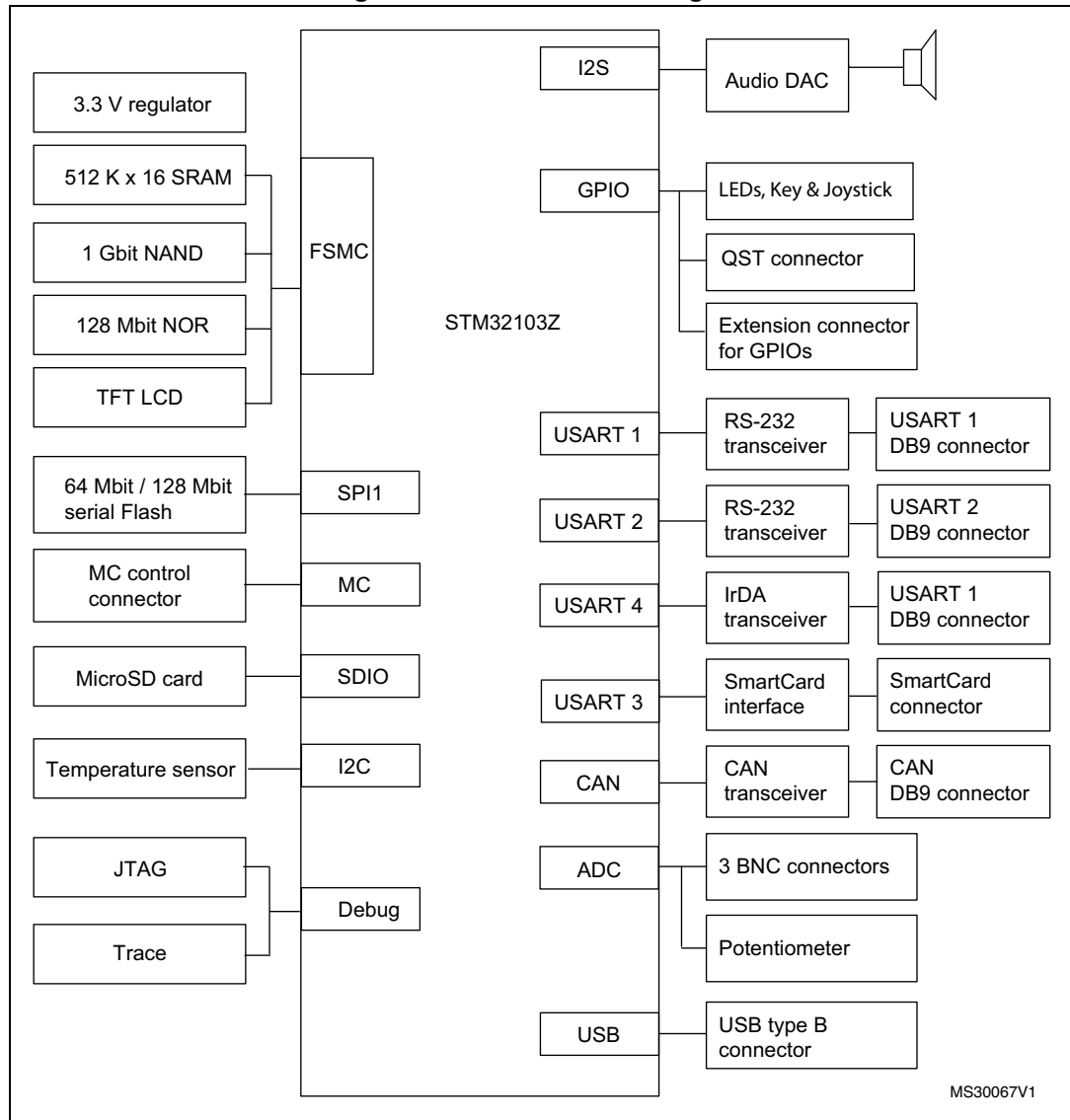
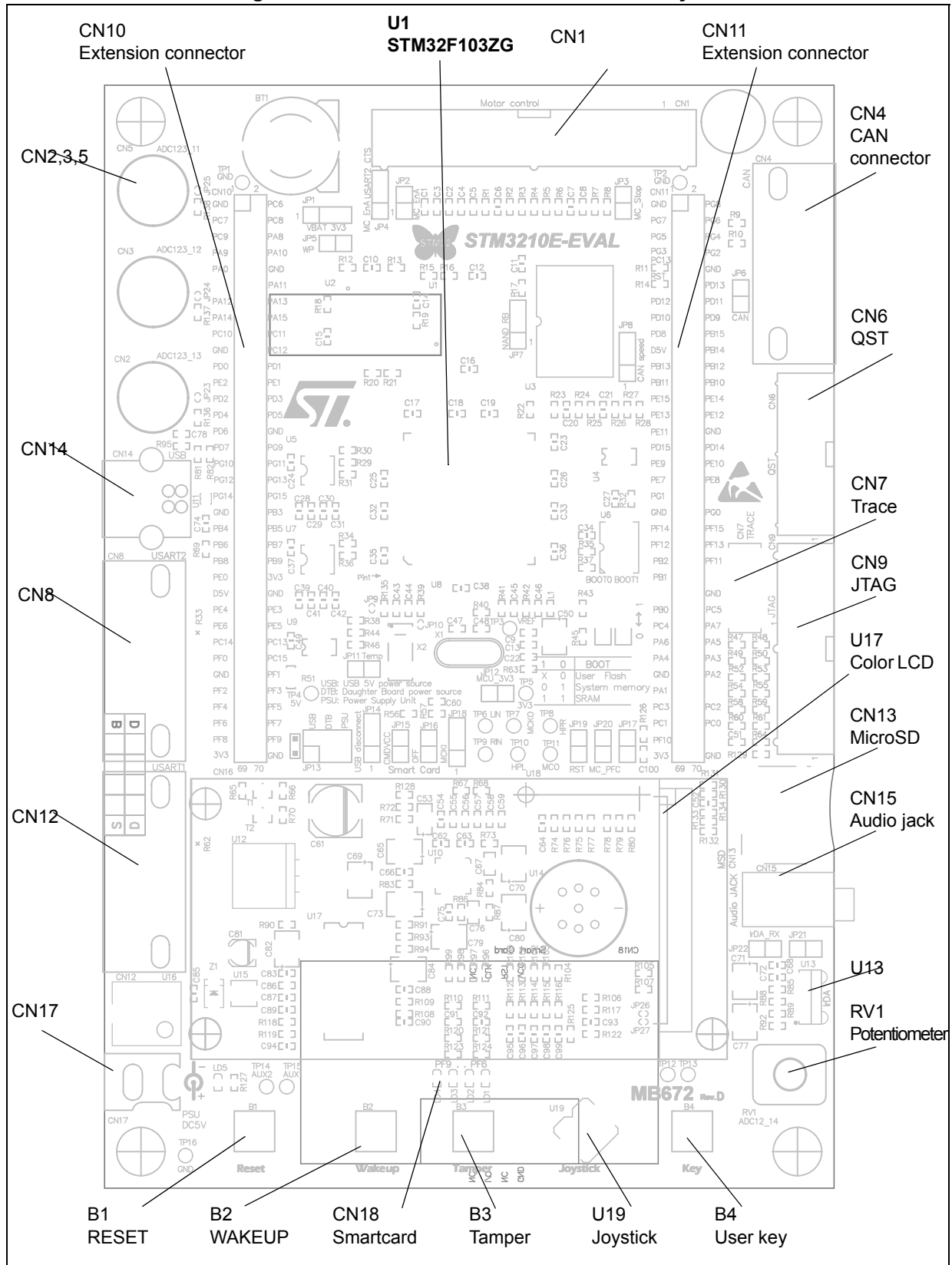


Figure 3. STM3210E-EVAL evaluation board layout




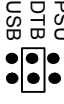

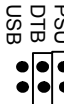


2.1 Power supply

The STM3210E-EVAL evaluation board is designed to be powered by 5V DC power supply and to be protected by PolyZen U15 in the event of wrong power plug-in. It is possible to configure the evaluation board to use any of following three sources for the power supply:

- 5V DC power adapter connected to CN17, the power jack on the board (PSU on silk screen for power supply unit).
- 5V DC power with 500 mA limitation from CN14, the type-B USB connector (USB on silkscreen).
- 5V DC power from both CN10 and CN11, the extension connector for daughterboard (DTB for daughterboard on silkscreen).

The power supply is configured by setting the related jumpers **JP13**, **JP12** and **JP1** as described in [Table 1](#). The LED LD5 is lit when the STM3210E-EVAL evaluation board is powered correctly.

Table 1. Power related jumpers

Jumper	Description
JP13	JP13 is used to select one of the three possible power supply resources. For power supply jack (CN17) to the STM3210E-EVAL <u>only</u> , JP13 is set as shown (default setting). 
	For power supply from the daughterboard connectors (CN10 and CN11) to STM3210E-EVAL <u>only</u> , JP13 is set as shown. 
	For power supply from USB (CN14) to STM3210E-EVAL <u>only</u> , JP13 is set as shown. 
	For power supply from power supply jack (CN17) to both STM3210E-EVAL and daughterboard connected on CN10 and CN11, JP13 is set as shown (daughterboard must not have its own power supply connected). 
JP12	Enables consumption measurements of both VDD and VDDA. Default setting: Fitted
JP1	V _{bat} is connected to 3.3V power when JP1 is set as shown (default setting). 
	V _{bat} is connected to battery when JP1 is set as shown. 






2.2 Boot option

The STM3210E-EVAL evaluation board can boot from:

- Embedded user Flash
- System memory with boot loader for ISP
- Embedded SRAM for debugging

The boot option is configured by setting the switches BOOT0 and BOOT1.

Table 2. Boot related switches

Switch	Boot from	Switch configuration
BOOT0 BOOT1	STM3210E-EVAL boots from User Flash when BOOT0 is set as shown to the right. BOOT1 is not required in this configuration. (Default setting)	 Boot 0 0 ←→ 1
	STM3210E-EVAL boot from Embedded SRAM when BOOT0 and BOOT1 are set as shown to the right.	 Boot 0  Boot 1 0 ←→ 1
	STM3210E-EVAL boot from System Memory when BOOT0 and BOOT1 are set as shown to the right.	 Boot 0  Boot 1 0 ←→ 1

2.3 Clock source

Two clock sources are available on the STM3210E-EVAL evaluation board for STM32F103 and RTC.

- X2, 32KHz crystal for embedded RTC.
- X1, 8MHz crystal with socket for STM32F103ZGT6 microcontroller, it can be removed from socket when internal RC clock is used.

2.4 Reset source

The reset signal of the STM3210E-EVAL evaluation board is low active and the reset sources include:

- Reset button B1
- Debugging tools from JTAG connector CN7 and trace connector CN9
- Daughterboard from CN11

Table 3. Reset related jumper



Jumper	Description
JP19	Enables reset of the STM32F103ZGT6 embedded JTAG TAP controller each time a system reset occurs. JP19 connects the TRST signal from the JTAG connection with the system reset signal RESET#. Default setting: not fitted

2.5 Audio

The STM3210E-EVAL evaluation board supports stereo audio play because it provides an audio DAC AK4343 connected to both I²S port and two channels of DAC of microcontroller STM32F103ZGT6. Either external slave mode or PLL slave mode (reference clock BICK or LRCK) of audio DAC can be used by setting the jumper JP18.

The I2S_MCK is multiplexed with smartcard and motor control, and can be enabled by setting the jumper JP15. Refer to [Section 2.9: Motor control](#) for details. Audio DAC AK4343 is in power-down mode when PDN pin is pulled-down by PG11.

Table 4. Audio related jumpers

Jumper	Description
JP18	External slave mode (MCK from STM32F103ZGT6) is selected when JP18 is set as shown (default setting). 
	PLL slave mode (reference clock BICK or LRCK) is selected when JP18 is set as shown. 



2.6 Serial Flash

A 64 or 128 Mbit serial Flash connected to SPI1 of STM32F103ZGT6 serial Flash chip select is managed by IO-pin PB2. The SPI1_MISO is multiplexed with motor control, it can be enabled by setting the jumper JP3. Refer to [Section 2.9: Motor control](#) for details.

2.7 CAN

The STM3210E-EVAL evaluation board supports CAN2.0A/B compliant CAN bus communication based on 3.3 V CAN transceiver. High-speed mode, standby mode and slope control mode are available and can be selected by setting JP8.

Table 5. CAN related jumpers

Jumper	Description
JP8	CAN transceiver works in standby mode when JP8 is set as shown. 
	CAN transceiver works in high-speed mode when JP8 is set as shown (default setting). 
	CAN transceiver works in slope control mode when JP8 is open.
JP6	CAN terminal resistor is enabled when JP6 is fitted. Default setting: not fitted

2.8 RS-232 connectors

Two D-type 9-pin connectors CN12 (USART1) and CN8 (USART2) are available on the STM3210E-EVAL evaluation board.

- USART1 connector is connected to RS-232 transceiver U7 .
- USART2 connector with RTS/CTS handshake signal support is connected to RS-232 transceiver U5. The USART2_CTS is multiplexed with motor control, it can be enabled by setting jumper JP4. Refer to [Section 2.9: Motor control](#) for details.

2.9 Motor control

The STM3210E-EVAL evaluation board supports three-phase brushless motor control via a 34-pin connector CN1, which provides all required control and feedback signals to and from the motor power driving board. Available signals on this connector include emergency stop, motor speed, three-phase motor current, bus voltage, heatsink temperature from the motor driving board and 6 channels of PWM control signals going to the motor driving circuit.

JP 20 selects one of the two synchronization methods for power factor correction (PFC).

The I/O pins used on the motor control connector CN1 are multiplexed with some peripherals on the board; either the motor control connector or multiplexed peripherals can be enabled by setting the jumpers **JP3, JP4, JP11, JP15** and **JP16** as described in [Table 6](#).

Table 6. Motor control related jumpers

Jumper	Description	Multiplexed peripherals
JP20	JP20 allows to have a PFC synchronization signal redirected to the timer 3 input capture 1 pin, and additionally to the timer 3 external trigger input. JTAG debugging is disabled when JP20 is fitted. Default setting: not fitted	
JP2	JP2 should be kept on open when encoder signal is input from pin 31 of CN1 while it should be kept on close when analog signal is from pin 31 of CN1 for special motor. Default setting: not fitted	
JP4	MC_EnA is enabled when JP4 is set as shown to the right (default setting): USART2_CTS is enabled when JP4 is set as show to the right:	USART2
JP3	MC_EmergencySTOP is enabled when JP3 is closed. The pin PA6 is used as SPI1_MISO when JP3 is open. Default setting: not fitted	SPI1
JP11	MC_PFCpwm is enabled when JP11 is open. The pin PB5 will be used as interrupt input from temperature sensor when JP11 is closed.	Temperature sensor
JP15	MC_UH or I2S_MCK are enabled when JP15 is open. The pin PC6 is used as Smartcard_CMDVCC when JP15 is closed.	I ² S and smartcard
JP16	MC_VH is enabled when JP16 is open. The pin PC7 is used as Smartcard_OFF when JP16 is closed	Smartcard

2.10 Smartcard

STMicroelectronics smartcard interface chip ST8024 is used on the STM3210E-EVAL board for asynchronous 3 V and 5 V smartcards. It performs all supply protection and control functions based on the connections with STM32F103ZGT6 listed in [Table 7](#).

The Smartcard_CMDVCC and Smartcard_OFF are multiplexed with motor control. They can be enabled by setting the jumpers JP15 and JP16. Refer to [Section 2.9: Motor control on page 12](#) for details.

Table 7. Connection between ST8024 and STM32F103ZGT6

ST8024 signals	Description	Connect to STM32F10X
5V/3V	Smartcard power supply selection pin	PB0
I/OUC	MCU data I/O line	PB10
XTAL1	Crystal or external clock input	PB12
OFF	Detect presence of a card, interrupt to MCU, share same pin with motor controller	PC7
RSTIN	Card reset input from MCU	PB11
CMDVCC	Start activation sequence input (active low), share same pin with I ² S DAC and motor control	PC6

Table 8. Smartcard related jumpers

Jumper	Description
JP15	The CMDVCC is connected to PC6 when JP15 is closed. It should be kept on open, or the SD Card needs to be removed from the MicroSD Card connector when PC6 is used by I ² S or motor control connector. Default setting: not fitted
JP16	The OFF is connected to PC7 when JP16 is closed. It has to be kept on open when PC7 is used by the motor control connector. Default setting: not fitted

2.11 MicroSD Card

The 128 Mbyte MicroSD Card connected to SDIO of STM32F103ZGT6 is available on the board. MicroSD Card detection is managed by standard IO port PF11.

The MicroSD Card_D3 is multiplexed with IrDA. It can be enabled by setting the jumper JP22, as explained in [Section 2.14: IrDA on page 14](#).

The MicroSD Card_D0 and MicroSD Card CMD are multiplexed with the motor control connector. They can be enabled by setting the jumpers JP17 and JP20.

Table 9. MicroSD Card related jumpers

Jumper	Description
JP17	JP17 is used to enable MicroSD Card data line D0. MicroSD Card D0 is enabled when JP17 is fitted. The JP17 should be kept on open when motor control connector CN1 is used. Default setting: fitted
JP20	JP20 is used by the motor control connector, refer to Table 6 for details. JP20 should be kept on open for MicroSD Card operation. JTAG debugging is disabled when JP20 is fitted.

2.12 Temperature sensor

One I²C interface temperature sensor STLM75 (–55°C to +125°C) connected to I²C of STM32F103ZGT6 is available on the board.

2.13 Analog input

Three BNC connectors CN2, CN3 and CN5 are connected to PC3, PC2 and PC1 of the STM32F103ZGT6 as external analog input. The 50 ohm terminal resistor can be enabled by closing the solder bridge JP23, JP24 and JP25 for each BNC connector. A low-pass filter can be implemented for each BNC connector CN5, CN3 and CN2 by replacing R5 and C22, R4 and C13, R3 and C9 with the right resistor and capacitor values, depending on the requirements of your application.

2.14 IrDA

IrDA communication is supported by the IrDA transceiver U13 connected to USART3 of STM32F103ZGT6. The IrDA transceiver can be enabled or disabled by JP21.



Table 10. IrDA related jumpers

Jumper	Description
JP21	Enables/disables the IrDA transceiver. IrDA is enabled when JP21 is fitted (default setting). IrDA is disabled when JP21 is not fitted.
JP22	IrDA_RX is enabled when JP22 is closed. I/O pin PC11 is data line 3 of the MicroSD Card when JP22 is open (default setting).

2.15 USB

The STM3210E-EVAL evaluation board supports USB2.0 compliant full speed communication via a USB type B connector (CN14). The evaluation board can be powered by this USB connection at 5 V DC with a 500 mA current limitation. USB disconnection simulation can be implemented by disconnecting the 1.5 K pull-up resistor from USB+ line. The USB disconnection simulation feature is enabled by setting JP14.

Table 11. USB related jumpers

Jumper	Description
JP14	The USB 1.5K pull-up resistor is always connected to USB+ line when JP14 is set as shown. 
	The USB 1.5K pull-up resistor can be disconnected by software from USB+ line when JP14 is set as shown. In this case, the USB connect/disconnect feature is managed by standard IO port PB14 (default setting). 

2.16 Development and debug support

The two debug connectors available on the STM3210E-EVAL evaluation board are:

- CN9: standard 20-pin JTAG interface connector, compliant with ARM7/9 debug tools.
- CN7: SAMTEC 20-pin connector FTSH-110-01-L-DV for both SWD and Trace, compliant with ARM CoreSight debug tools.

2.17 Display and input devices

The 240x320 TFT color LCD connected to bank1 NOR/PSRAM4 of FSMC interface of the STM32F103ZGT6 and four general purpose color LEDs (LD 1,2,3,4) are available as display devices. A 4-direction joystick with selection key, general purpose button (B4), wakeup button (B2) and tamper detection button (B3) are available as input devices. The jumper JP4 should be kept open to enable the wakeup button B2 which shares the same I/O with USART2 and motor control connector.

The STM3210E-EVAL evaluation board also supports a second optional 122x32 graphic LCD that can be mounted on the U18 connector. By default, the graphic LCD is not present.

Table 12. LCD modules

TFT LCD CN16 (default)			Graphic LCD U18 (optional)		
Pin on CN16	Description	Pin connection	Pin on U18	Description	Pin connection
1	CS	CS of Bank3 of FSMC	1	Vss	GND
2	RS	FSMC_A0	2	Vcc	3.3V
3	WR/SCL	FSMC_NWE	3	VO	-
4	RD	FSMC_NOE	4	CLK	PA5
5	RESET	RESET#	5	SID	PA7
6	PD1	FSMC_D0	6	CS	PF10
7	PD2	FSMC_D1	7	A	+5V
8	PD3	FSMC_D2	8	K	GND
9	PD4	FSMC_D3			

Table 12. LCD modules (continued)

TFT LCD CN16 (default)			Graphic LCD U18 (optional)		
Pin on CN16	Description	Pin connection	Pin on U18	Description	Pin connection
10	PD5	FSMC_D4			
11	PD6	FSMC_D5			
12	PD7	FSMC_D6			
13	PD8	FSMC_D7			
14	PD10	FSMC_D8			
15	PD11	FSMC_D9			
16	PD12	FSMC_D10			
17	PD13	FSMC_D11			
18	PD14	FSMC_D12			
19	PD15	FSMC_D13			
20	PD16	FSMC_D14			
21	PD17	FSMC_D15			
22	BL_GND	GND			
23	BL_control	3.3V			
24	VDD	3.3V			
25	VCI	3.3V			
26	GND	GND			
27	GND	GND			
28	BL_VDD	3.3V			
29	SDO	PA6 via JP26			
30	SDI	PA7 via JP27			

2.18 SRAM

512Kx16 SRAM is connected to bank1 NOR/PSRAM3 of the FSMC interface and both 8-bit and 16-bit access are allowed by BLN0 and BLN1 connected to BLE and BHE of SRAM respectively.

2.19 NAND Flash

The 512 Mbit x8 or 1 Gbit x8 NAND Flash is connected to bank2 of the FSMC interface. The ready/busy signal can be connected to either WAIT signal or FSMC_INT2 signal of the STM32F103ZGT6 depending on the setting of JP7.

Table 13. NAND Flash related jumpers

Jumper	Description
JP7	The ready/busy signal is connected to WAIT signal when JP7 is set as shown (default setting)
	The ready/busy signal is connected to FSMC_INT2 signal when JP7 is set as shown.



2.20 NOR Flash

128 Mbit NOR Flash is connected to bank1 NOR/PSRAM2 of the FSMC interface. The 16-bit operation mode is selected by a pull-up resistor connected to the BYTE pin of the NOR Flash. Write protection can be enabled or disabled by jumper JP5.

Table 14. NOR Flash related jumpers

Jumper	Description
JP5	Write protection is enabled when JP5 is fitted. Write protection is disabled when JP5 is not fitted (default setting).

Three different NOR 128-Mbit references can be present on the evaluation board depending on component availability.

Table 15. NOR Flash reference

Reference	Manufacturer
M29W128GL70ZA6E	NUMONYX
M29W128GH70ZA6E	NUMONYX
S29GL128P90FFIR20	SPANSION

These three references are not identical in terms of ID code, speed, timing or block protection. The demonstration firmware and the software library delivered with the board support these three NOR Flash references. However, during the development of your application software, you must verify which NOR reference is implemented on your board (component referenced as U2 on silkscreen and schematic), and take its characteristics into account.

3 Connectors

3.1 Motor control connector CN1

Figure 4. Motor control connector CN1 (top view)

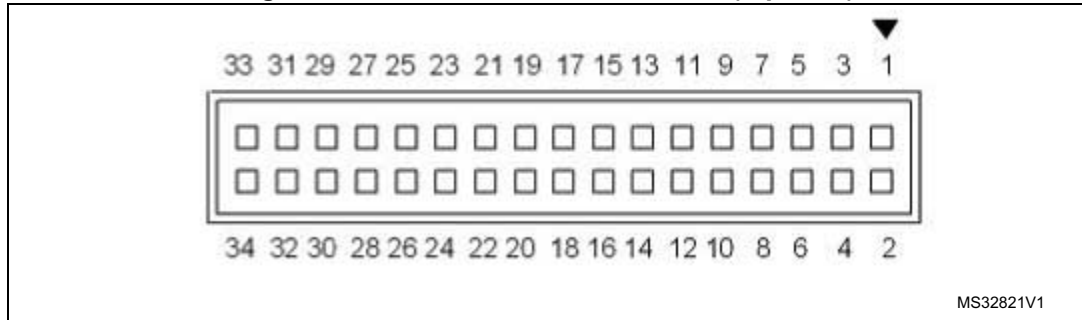


Table 16. Motor control connector CN1

Description	STM32F103Z GT6 pin	CN1 pin #	CN1 pin #	STM32F103Z GT6 pin	Description
Emergency stop	PA6	1	2		GND
PWM-UH	PC6	3	4		GND
PWM-UL	PA7	5	6		GND
PWM-VH	PC7	7	8		GND
PWM-VL	PB0	9	10		GND
PWM-WH	PC8	11	12		GND
PWM-WL	PB1	13	14	PC0	Bus voltage
Phase A current	PC1	15	16		GND
Phase B current	PC2	17	18		GND
Phase C current	PC3	19	20		GND
NTC bypass relay	PB12	21	22		GND
Dissipative brake PWM	PA3 through 0 ohm resistor unfitted	23	24		GND
+5V power	+5V	25	26	PC5	Heatsink temperature
PFC SYNC	PB4 and PD2	27	28		3.3V power
PFC PWM	PB5	29	30		GND
Encoder A	PA0	31	32		GND
Encoder B	PA1	33	34	PA2	Encoder index

3.2 Analog input connectors CN2, CN3 and CN5

Figure 5. Analog input connector CN2, CN3 and CN5 bottom view

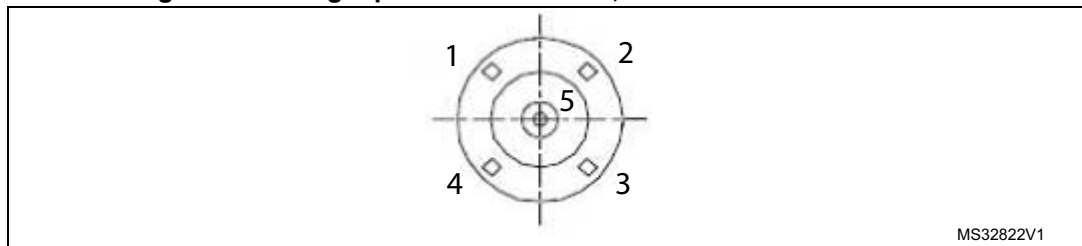


Table 17. Analog input connector CN2, CN3 and CN5

Pin number	Description	Pin number	Description
1	GND	4	GND
2	GND	5	Analog input PC3, PC2 and PC1 for CN2, CN3 and CN5 respectively
3	GND		

3.3 CAN D-type 9-pin male connector CN4

Figure 6. CAN D-type 9-pin male connector CN4 (front view)

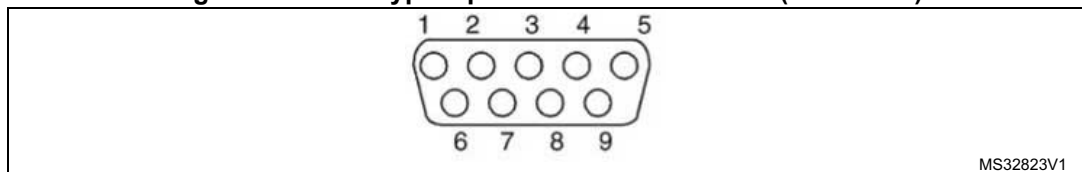


Table 18. CAN D-type 9-pins male connector CN4

Pin number	Description	Pin number	Description
1,4,8,9	NC	7	CANH
2	CANL	3,5,6	GND

3.4 QST connector CN6

The QST connector connects the STM3210E-EVAL to the QST evaluation board to demonstrate the QST function.

Figure 7. QST connector CN6 (front view)

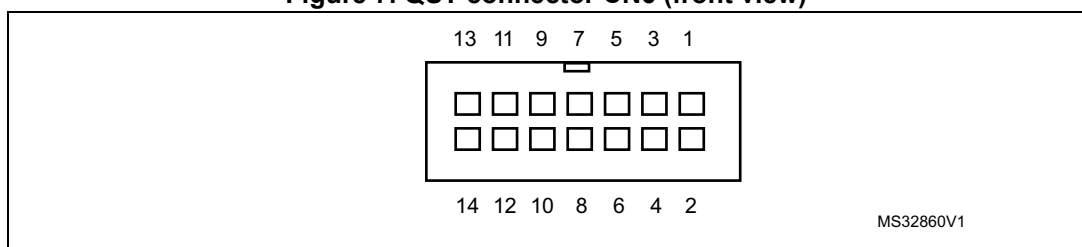


Table 19. QST connector CN6

Pin number	Description	Pin number	Description
1	+5V	2	+5V
3	PB6	4	PA5
5	PB7	6	PA7
7	PB1	8	PA6
9	PF11	10	PB5
11	PA8	12	-
13	GND	14	GND

3.5 Trace debugging connector CN7

Figure 8. Trace debugging connector CN7 (top view)

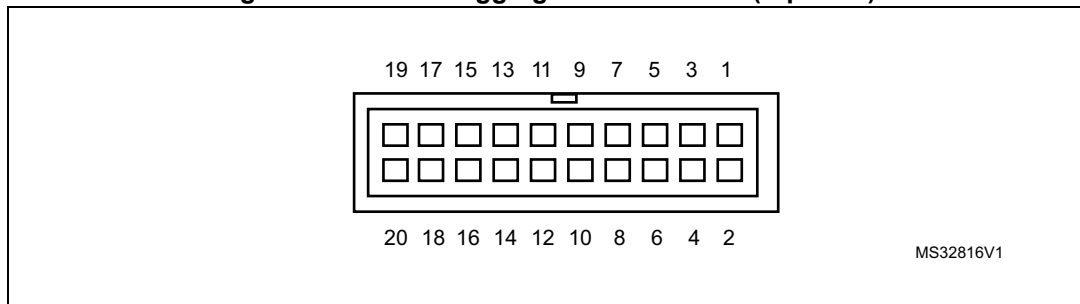


Table 20. Trace debugging connector CN7

Pin number	Description	Pin number	Description
1	3.3V power	2	TMS/PA13
3	GND	4	TCK/PA14
5	GND	6	TDO/PB3
7	KEY	8	TDI/PA15
9	GND	10	RESET#
11	GND	12	TraceCLK/PE2
13	GND	14	TraceD0/PE3 or SWO/PB3
15	GND	16	TraceD1/PE4 or nTRST/PB4
17	GND	18	TraceD2/PE5
19	GND	20	TraceD3/PE6

3.6 RS-232 connector CN8 with RTS/CTS handshake support

Figure 9. RS-232 connector CN8 with RTS/CTS handshake support (front view)

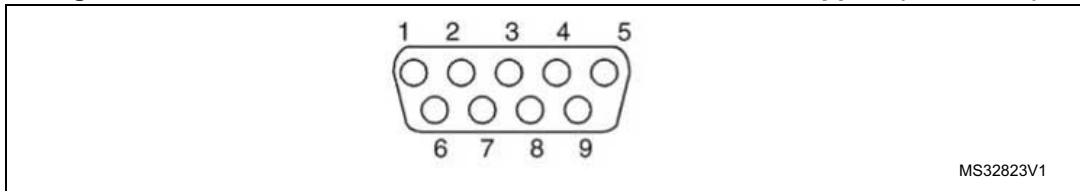


Table 21. RS-232 connector CN8 with RTS/CTS handshake support

Pin number	Description	Pin number	Description
1	NC	6	Connect to Pin 4
2	USART2_PA3	7	USART2_PA1
3	USART2_PA2	8	USART2_PA0
4	Connect to Pin 6	9	NC
5	GND		

3.7 JTAG debugging connector CN9

Figure 10. JTAG debugging connector CN9 (top view)

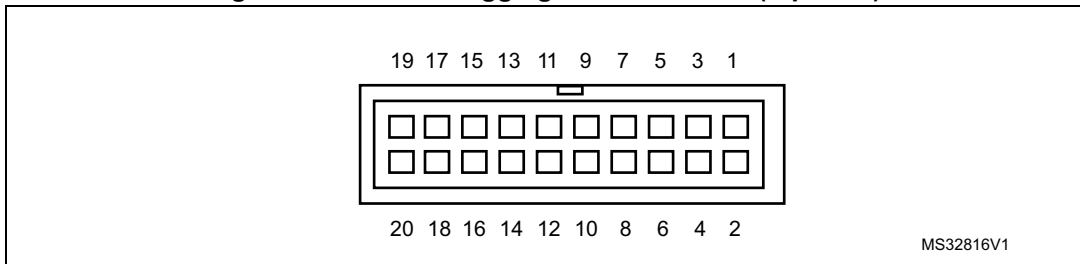


Table 22. JTAG debugging connector CN9

Pin number	Description	Pin number	Description
1	3.3V power	2	3.3V power
3	PB4	4	GND
5	PA15	6	GND
7	PA13	8	GND
9	PA14	10	GND
11	RTCK	12	GND
13	PB3	14	GND
15	RESET#	16	GND
17	DBGREQ	18	GND
19	DBGACK	20	GND

3.8 Daughterboard extension connectors CN10 and CN11

Two 70-pin male headers CN10 and CN11 can be used to connect a daughterboard or standard wrapping board to the STM3210E-EVAL evaluation board. All total 112 GPIOs are available on it. The space between these two connectors and the position of power, GND and RESET pins (marked in gray in [Table 23](#) and [Table 24](#)) are defined as a standard which allows to develop common daughterboards for several evaluations boards. The standard width between CN10 pin1 and CN11 pin1 is 2700 mils (68.58 mm). This standard is implemented on the majority of evaluation boards.

Each pin on CN10 and CN11 can be used by a daughterboard after disconnecting it from the corresponding function block on the STM3210E-EVAL evaluation board, as described in [Table 23](#) and [Table 24](#).

Table 23. Daughterboard extension connector CN10

Pin #	Description	Alternative function	How to disconnect from function block on STM3210E-EVAL board
1	GND	-	-
3	PC7	MC/Smartcard	Disconnect STM3210E-EVAL evaluation board from motor power drive board. Keep JP16 on open.
5	PC9	MicroSD Card	Remove SD Card from MicroSD Card connector.
7	PA9	UASRT1_TX	-
9	PA0	MC/Wakeup/USART2_CTS	Keep JP4 on open.
11	-	-	-
13	PA12	USB_DP	Remove R82.
15	PA14	Debug_TCK	-
17	PC10	IrDA_TX/MicroSDcard_D2	Remove SD Card from MicroSD Card connector.
19	GND	-	-
21	PD0	FSMC_D2	-
23	PE2	Trace_CLK/FSMC_A23	-
25	PD2	MicroSDcard_CMD/MC	Disconnect STM3210E-EVAL evaluation board from motor power drive board. Remove SD Card from MicroSD Card connector.
27	PD4	FSMC_OEN	-
29	PD6	FSMC_WAITN	-
31	PD7	FSMC_EBAR0	Remove R22.
33	PG10	FSMC_EBAR2	Remove R15.
35	PG12	FSMC_EBAR3	Remove R77.
37	PG14	Joystick_Left	Remove R102.
39	GND	-	-

Table 23. Daughterboard extension connector CN10 (continued)

Pin #	Description	Alternative function	How to disconnect from function block on STM3210E-EVAL board
41	PB4	Debug_TRST/MC	Disconnect STM3210E-EVAL evaluation board from motor power drive board. Keep JP19 on open.
43	PB6	I2C_SCL/QST	Disconnect STM3210E-EVAL evaluation board from QST board.
45	PB8	CAN_RX	Remove R32.
47	PE0	FSMC_BLN0	-
49	D5V	-	-
51	PE4	Trace_D1/FSMC_A20	-
53	PE6	Trace_D3/FSMC_A22	-
55	PC14	OSC32_IN	Remove R135, Keep JP9 (solder bridge) on close.
57	PF0	FSMC_A0	-
59	GND	-	-
61	PF2	FSMC_A2	-
63	PF4	FSMC_A4	-
65	PF6	LD2	Remove R96.
67	PF8	LD4	Remove R98.
69	+3V3	-	-
2	PC6	Smartcard/MC/I2S_MCK	Disconnect STM3210E-EVAL evaluation board from motor power drive board. Keep JP15 on open.
4	PC8	MicroSDcard_D0/MC	Disconnect STM3210E-EVAL evaluation board from motor power drive board. Remove SD Card from MicroSD Card connector.
6	PA8	MCO/LCD_backlight/QST	Disconnect STM3210E-EVAL evaluation board from QST board.
8	PA10	USART1_RX	Remove R36.
10	GND	-	-
12	PA11	USB_DM	Remove R81.
14	PA13	Debug TMS	-
16	PA15	Debug TDI	-
18	PC11	IrDA_RX/MicroSDcard_D2	Remove SD Card from MicroSD Card connector. Remove R89.
20	PC12	MicroSDcard_CLK	Remove SD Card from MicroSD Card connector.
22	PD1	FSMC_D3	-
24	PE1	FSMC_BLN1	-
26	PD3	Joystick_Down	Remove R100.

Table 23. Daughterboard extension connector CN10 (continued)

Pin #	Description	Alternative function	How to disconnect from function block on STM3210E-EVAL board
28	PD5	FSMC_WEN	-
30	GND	-	-
32	PG9	FSMC_EBAR1	Remove R21.
34	PG11	-	-
36	PG13	Joystick_Right	Remove R103.
38	PG15	Joystick_Up	Remove R104.
40	PB3	Debug_TDO	-
42	PB5	MC/QST/Temperature sensor	Disconnect STM3210E-EVAL evaluation board from motor power drive board and QST board. Remove R46.
44	PB7	I2C_SDA/QST	Disconnect STM3210E-EVAL evaluation board from QST board.
46	PB9	CAN_TX	-
48	3V3	-	-
50	GND	-	-
52	PE3	Trace_D0/FSMC_A19	-
54	PE5	Trace_D2/FSMC_A21	-
56	PC13	Anti-tamper button	Remove R111.
58	PC15	OSC32_OUT	Remove R39, Keep JP10 (solder bridge) on close.
60	PF1	FSMC_A1	-
62	PF3	FSMC_A3	-
64	PF5	FSMC_A5	-
66	PF7	LD3	Remove R97.
68	PF9	LD5	Remove R99.
70	GND	-	-

Table 24. Daughterboard extension connector CN11

Pin #	Description	Alternative function	How to disconnect from function block on STM3210E-EVAL board
1	GND	-	-
3	PG7	Joystick_Select	Remove R101.
5	PG5	FSMC_A15	-
7	PG3	FSMC_A13	-
9	PC13 Button B3	-	-
11	RESET#	-	-
13	PD12	FSMC_A17	-
15	PD10	FSMC_D15	-
17	PD8	FSMC_D13	-
19	D5V	-	-
21	PB13	I2S_CLK	-
23	PB11	Smartcard_Reset	-
25	PE15	FSMC_D12	-
27	PE13	FSMC_D10	-
29	PE11	FSMC_D8	-
31	PD15	FSMC_D1	-
33	PE9	FSMC_D6	-
35	PE7	FSMC_D4	-
37	PG1	FSMC_A11	-
39	GND	-	-
41	PF14	FSMC_A8	-
43	PF12	FSMC_A6	-
45	PB2	BOOT1/SPI_NSS	-
47	PB1	MC/QST	Disconnect STM3210E-EVAL evaluation board from motor power drive board and QST board.
49	-	-	-
51	PB0	Smartcard_3/5V/MC	Disconnect STM3210E-EVAL evaluation board from motor power drive board.
53	PC4	Potentiometer	Remove R126.
55	PA6	MC/SPI_MISO/QST	Disconnect STM3210E-EVAL evaluation board from motor power drive board and QST board. Remove R37.
57	PA4	Audio_RIN	Remove R67.
59	GND	-	-

Table 24. Daughterboard extension connector CN11 (continued)

Pin #	Description	Alternative function	How to disconnect from function block on STM3210E-EVAL board
61	PA1	MC/USART2_RTS	Disconnect STM3210E-EVAL evaluation board from motor power drive board.
63	PC3	MC/BNC3	Disconnect STM3210E-EVAL evaluation board from motor power drive board. Disconnect analog signal from BNC3.
65	PC1	MC/BNC1	Disconnect STM3210E-EVAL evaluation board from motor power drive board. Disconnect analog signal from BNC1.
67	PF10	LCD_CS	-
69	+3V3	-	-
2	PG8	User button B4	Remove R106.
4	PG6	FSMC_INT2	Keep JP7 on open.
6	PG4	FSMC_A14	-
8	PG2	FSMC_A12	-
10	GND	-	-
12	PD13	FSMC_A18	-
14	PD11	FSMC_A16	-
16	PD9	FSMC_A14	-
18	PB15	I2S_DIN	-
20	PB14	USB disconnect	Connect pin1 of JP14 to pin2.
22	PB12	Smartcard_CK/MC/I2S_CMD	Disconnect STM3210E-EVAL evaluation board from motor power drive board.
24	PB10	Smartcard_IO	Remove R94.
26	PE14	FSMC_D11	-
28	PE12	FSMC_D9	-
30	GND	-	-
32	PD14	FSMC_D0	-
34	PE10	FSMC_D7	-
36	PE8	FSMC_D5	-
38	-	-	-
40	PG0	FSMC_A10	-
42	PF15	FSMC_A9	-
44	PF13	FSMC_A7	-
46	PF11	QST / MicroSD Card detection	Disconnect STM3210E-EVAL evaluation board from QST board. Remove SD Card from card socket CN13.
48	-	-	-

Table 24. Daughterboard extension connector CN11 (continued)

Pin #	Description	Alternative function	How to disconnect from function block on STM3210E-EVAL board
50	GND	-	-
52	PC5	MC	Disconnect STM3210E-EVAL evaluation board from motor power drive board.
54	PA7	MC/SPI_MOSI/QST	Disconnect STM3210E-EVAL evaluation board from motor power drive board and QST board.
56	PA5	SPI_CLK/DAC_LIN/QST	Disconnect STM3210E-EVAL evaluation board from QST board. Remove R68.
58	PA3	MC/USART2_RX	Disconnect STM3210E-EVAL evaluation board from motor power drive board. Remove R29.
60	PA2	MC/USART2_TX	Disconnect STM3210E-EVAL evaluation board from motor power drive board.
62	-	-	-
64	PC2	MC/BNC2	Disconnect STM3210E-EVAL evaluation board from motor power drive board. Disconnect analog signal from BNC2.
66	PC0	MC	Disconnect STM3210E-EVAL evaluation board from motor power drive board. Remove C7 & R63.
68	-	-	-
70	GND	-	-

3.9 RS-232 connector CN12

Figure 11. RS-232 connector CN12 (front view)

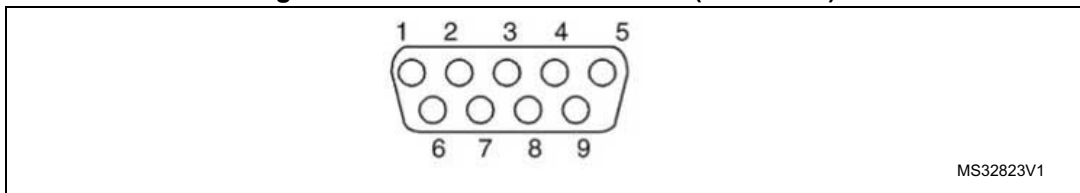


Table 25. RS-232 connector CN12

Pin number	Description	Pin number	Description
1	NC	6	Connect to Pin 4
2	USART1_PA10	7	Connect to Pin 8
3	USART1_PA9	8	Connect to Pin 7
4	Connect to Pin 6	9	NC
5	GND		

3.10 MicroSD Card connector CN13

Figure 12. MicroSD Card connector CN13 (front view)

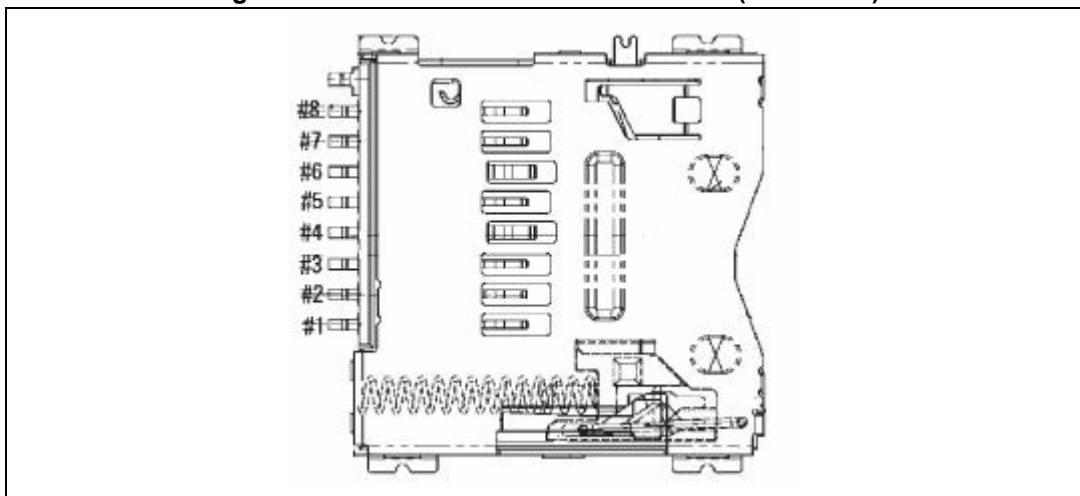
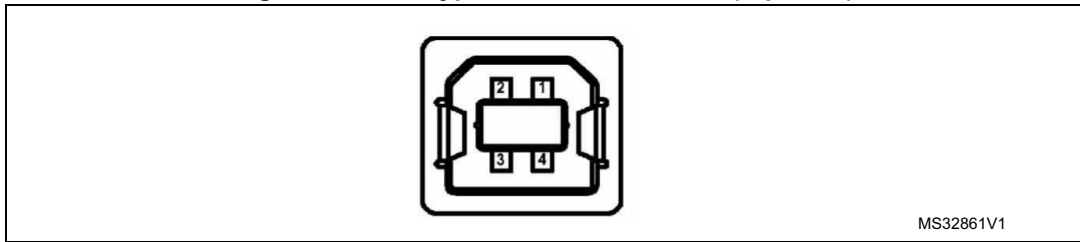


Table 26. MicroSD Card connector CN13

Pin number	Description	Pin number	Description
1	MicroSDcard_D2 (PC10)	5	MicroSDcard_CLK (PC12)
2	MicroSDcard_D3 (PC11)	6	Vss/GND
3	MicroSDcard_CMD (PD2)	7	MicroSDcard_D0 (PC8)
4	+3V3	8	MicroSDcard_D1 (PC9)
		9	MicroSDcard_detect (PF11)

3.11 USB type B connector CN14

Figure 13. USB type B connector CN14 (top view)



MS32861V1

Table 27. USB type B connector CN14

Pin number	Description	Pin number	Description
1	VBUS (power)	4	GND
2	PA11	5,6	Shield
3	PA12		

3.12 Audio jack CN15

A 3.5 mm stereo audio jack CN15 connected to the audio DAC is available on the STM3210E-EVAL board.

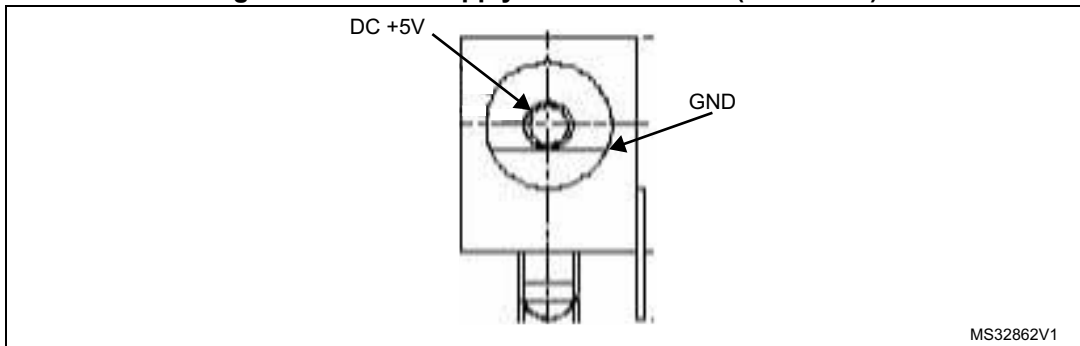
3.13 TFT LCD connector CN16

One 30-pin male header is available on the board to connect the LCD module board MB895 to the FSMC interface of the STM32F103ZGT6. Refer to [Section 2.17: Display and input devices on page 15](#) for details.

3.14 Power connector CN17

Your STM3210E-EVAL board can be powered from a DC 5 V power supply via the external power supply jack (CN17) shown in [Figure 14](#). The central pin of CN17 must be positive.

Figure 14. Power supply connector CN17 (front view)



MS32862V1

3.15 Smartcard connector CN18

Figure 15. Smartcard connector CN18 (front view)

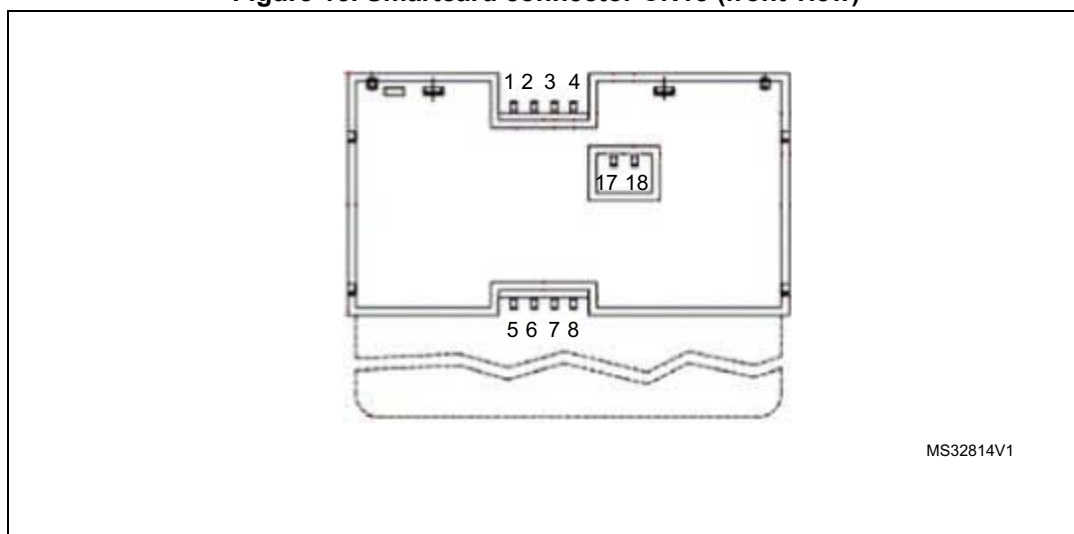


Table 28. Smartcard connector CN18

Pin number	Description	Pin number	Description
1	VCC	5	GND
2	RST	6	NC
3	CLK	7	I/O
4	NC	8	NC
17	Detection pin of card presence	18	Detection pin of card presence

4 Schematic diagrams

This section provides the design schematics for the STM3210E-EVAL board key features, to help you implement these features in your applications. Schematics are provided for:

- Microcontroller connections, see [Figure 16](#)
- MCU, see [Figure 17](#)
- Peripherals, see [Figure 18](#)
- RS-232 and IrDA, see [Figure 19](#)
- Audio, see [Figure 20](#)
- LCD and joystick, see [Figure 21](#)
- SD Card and smartcard, see [Figure 22](#)
- Motor control, see [Figure 23](#)
- JTAG and trace, see [Figure 24](#)
- Power supply, see [Figure 25](#)
- SRAM and Flash, see [Figure 26](#)
- Color LCD module, see [Figure 27](#)

Figure 17. MCU

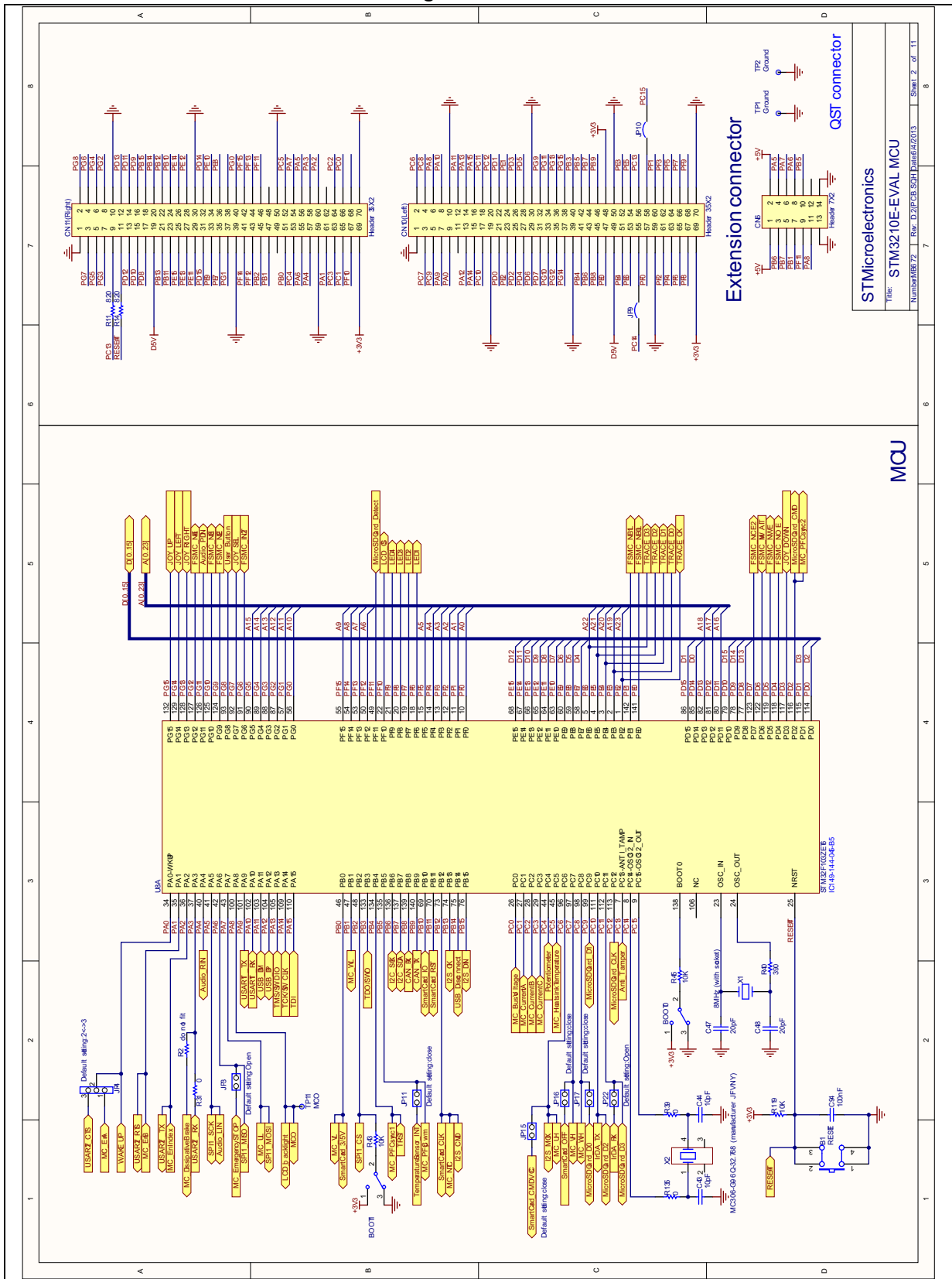
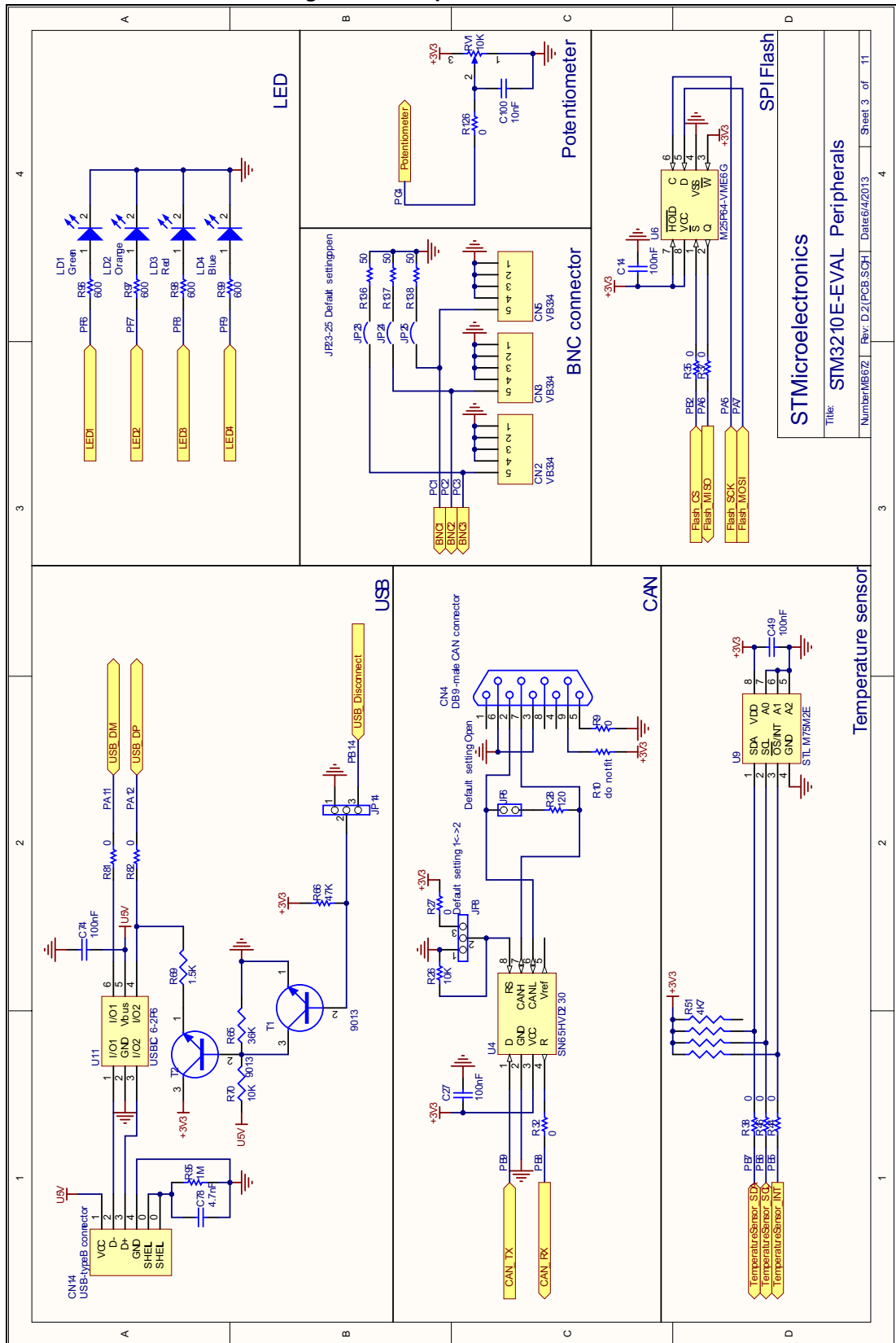


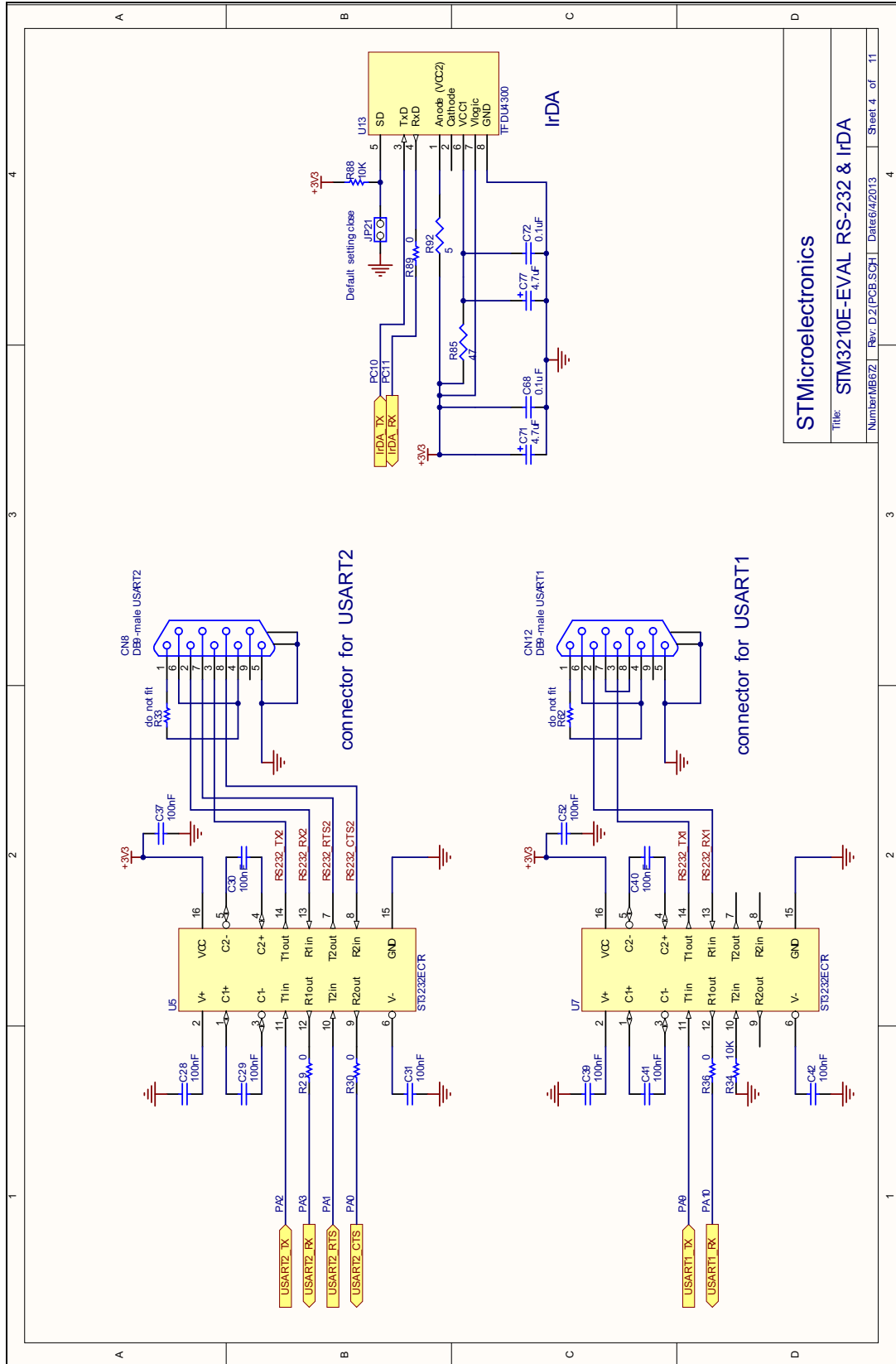
Figure 18. Peripherals



STMicroelectronics
 Title: STM3210E-EVAL Peripherals
 Number: MB66Z Rev. D.2 (PCB SGH) Date: 6/4/2013 Sheet 3 of 11

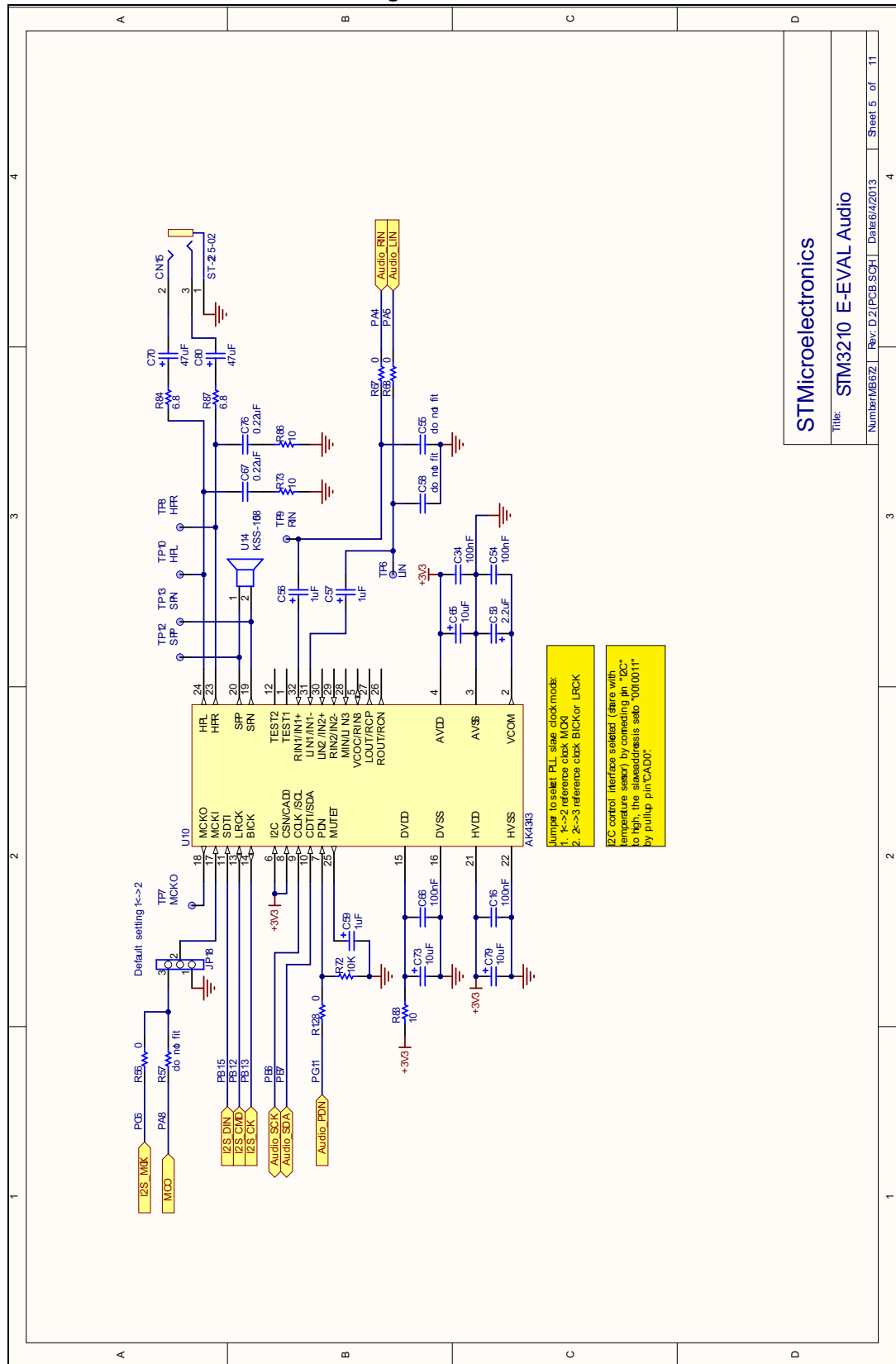


Figure 19. RS-232 and IrDA



STMicroelectronics	
Title: STM3210E-EVAL RS-232 & IrDA	
Number: MB62	Rev: D2 PCB SCH Date: 6/4/2013
Sheet 4 of 11	

Figure 20. Audio



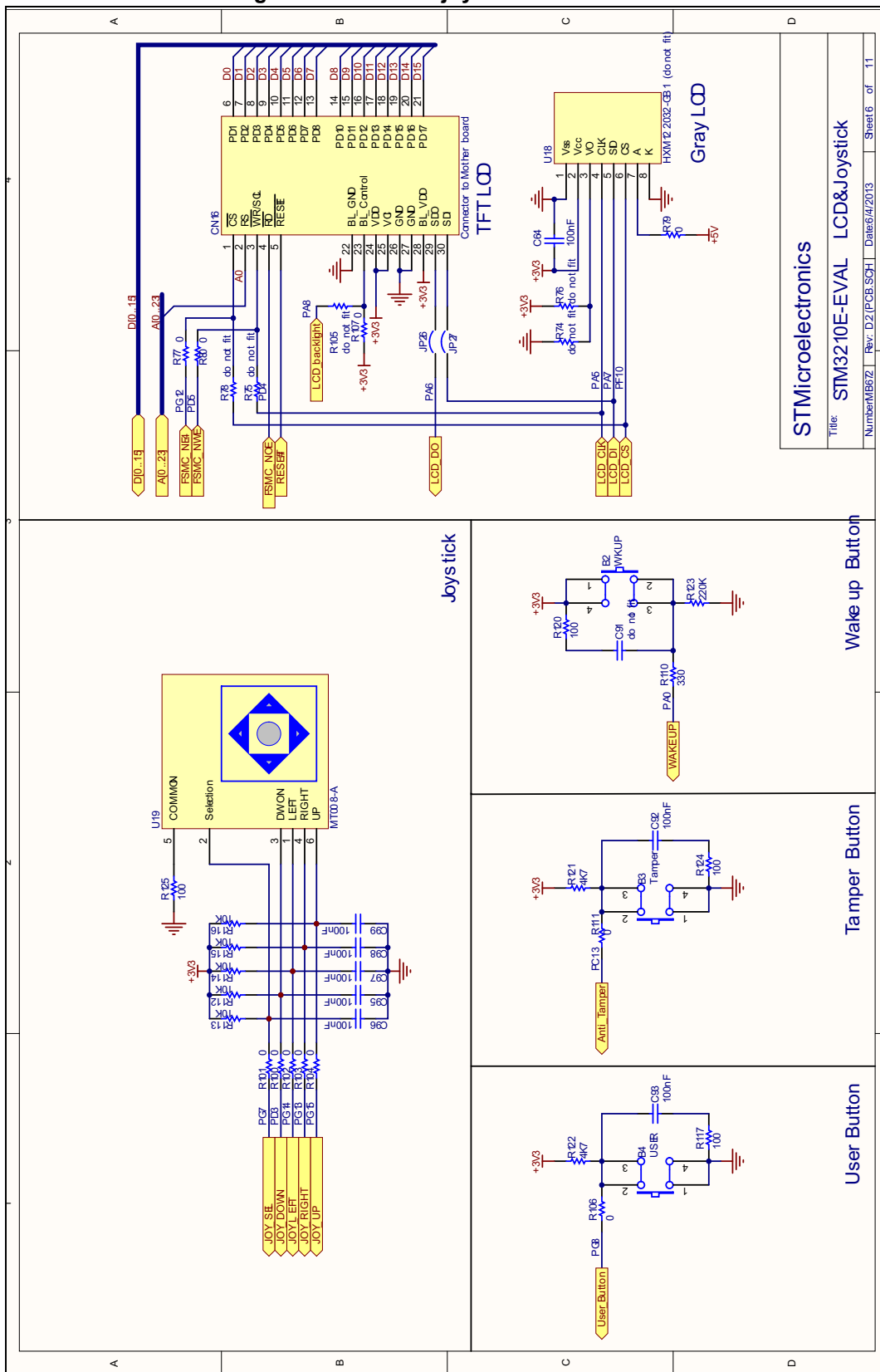
STMicroelectronics

Title: STM3210 E-EVAL Audio

Number: MB62 Rev: D2(PCB_SCH) Date: 6/4/2013 Sheet 5 of 11

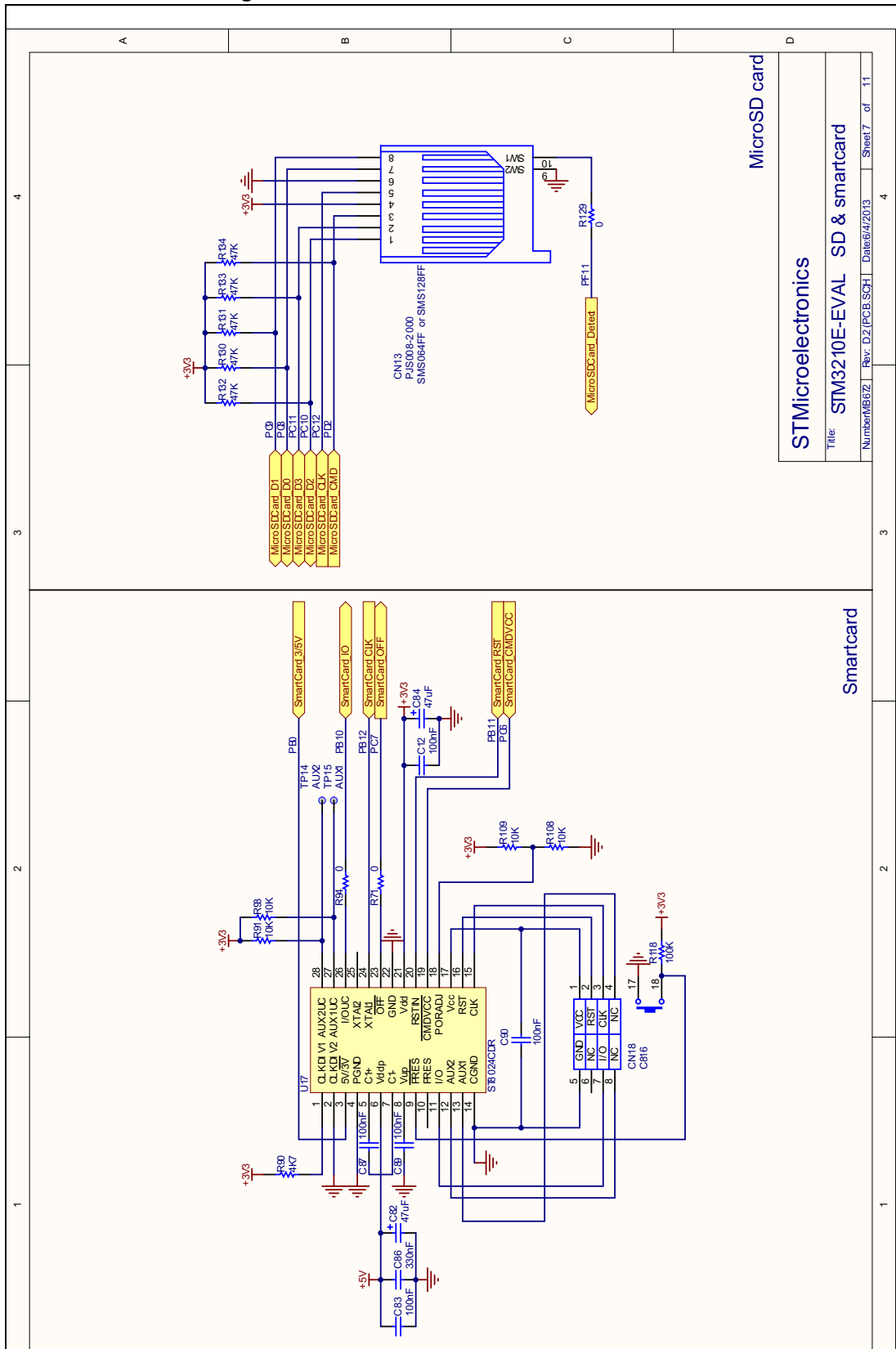


Figure 21. LCD and joystick



STMicroelectronics	
Title: STM3210E-EVAL LCD&Joystick	
Number: MB62	Rev: D2 PCB: SGH Date: 6/4/2013
Sheet 6 of 11	

Figure 22. SD Card and smartcard



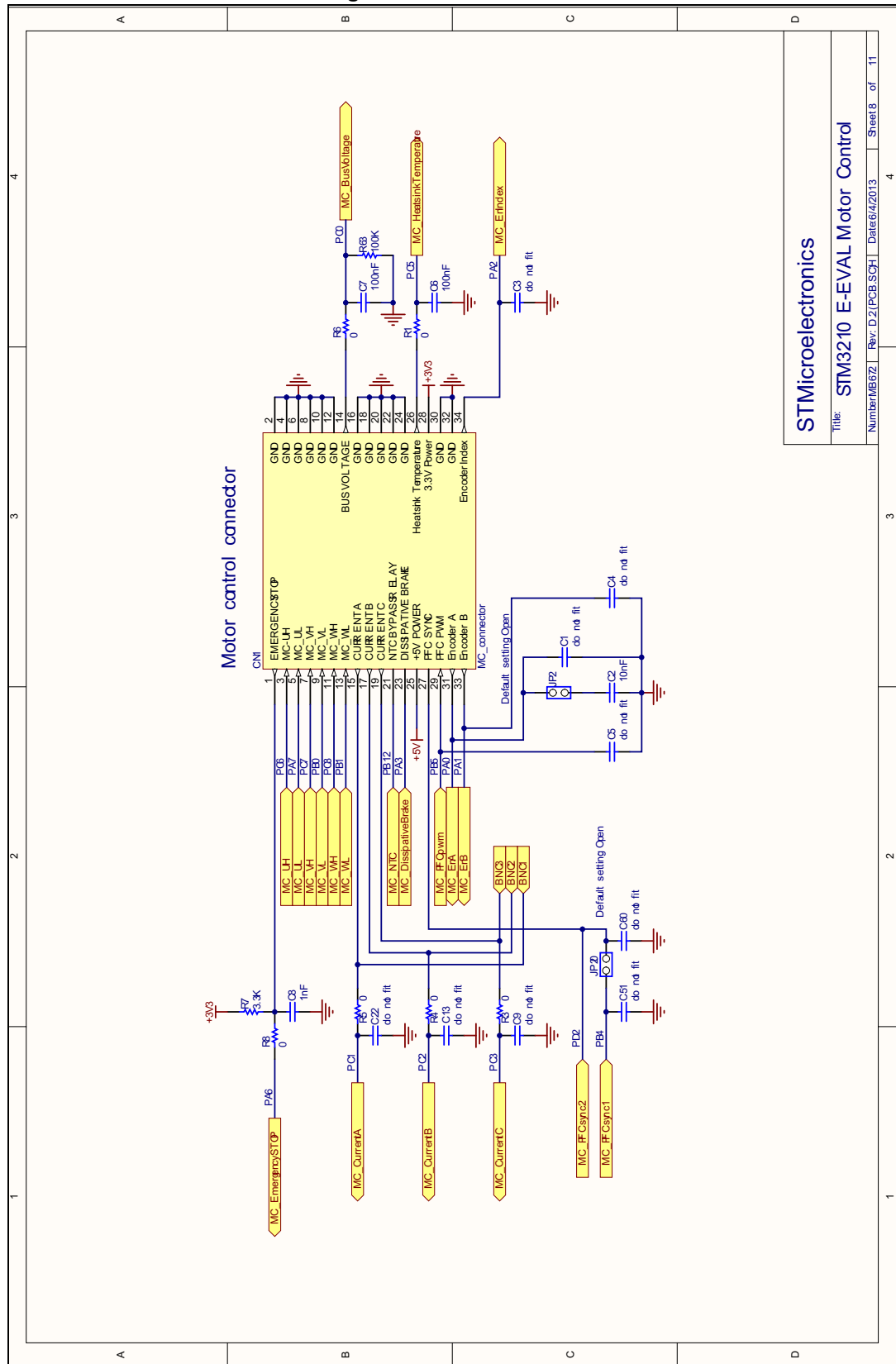
MicroSD card

STMicroelectronics	
Title: STM3210E-EVAL SD & smartcard	
Number: MB62	Rev: D2 (PCB.SGH)
Date: 6/4/2013	Sheet 7 of 11

Smartcard



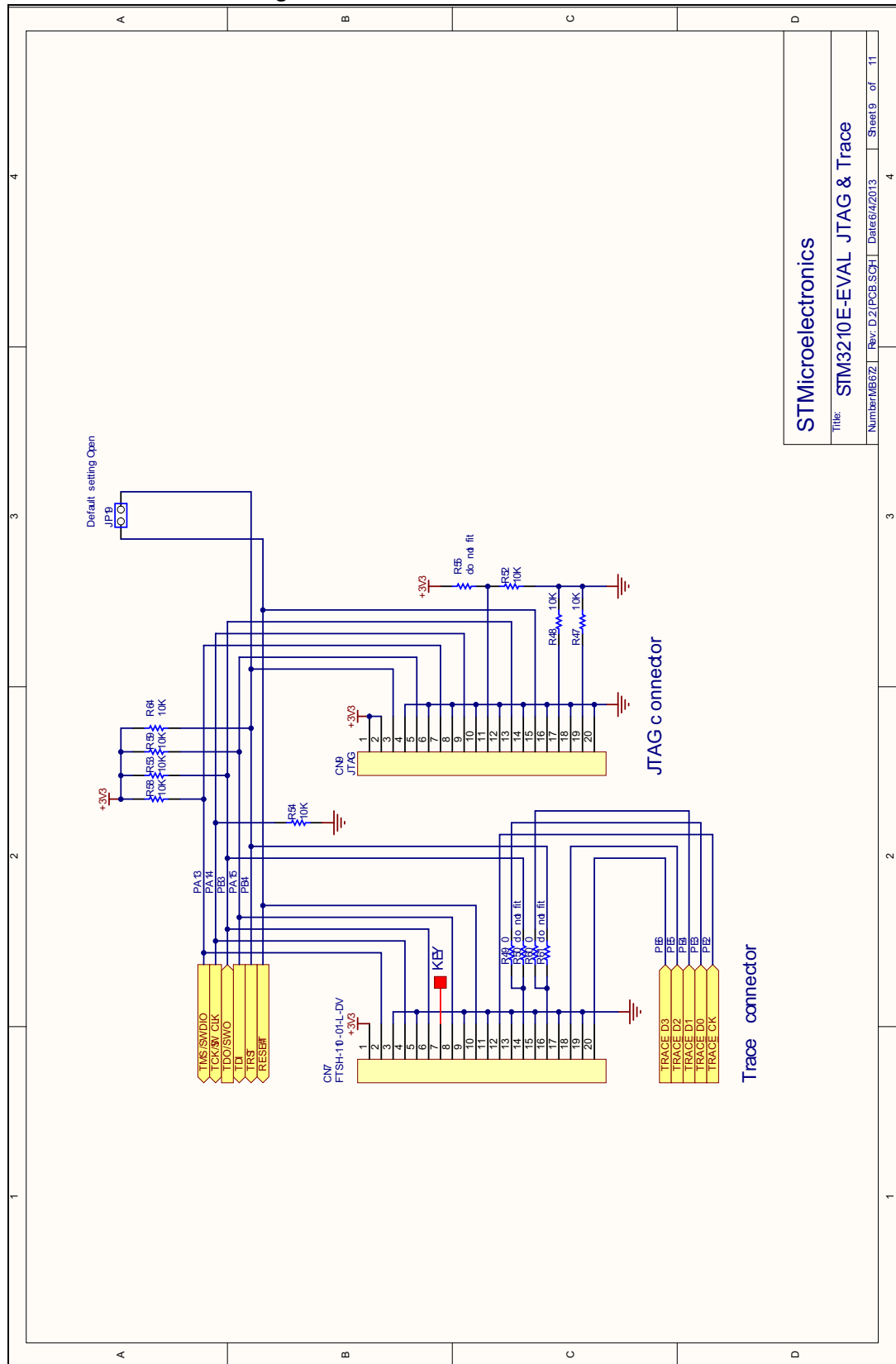
Figure 23. Motor control



STMicroelectronics	
Title: STM3210 E-EVAL Motor Control	
Number: MB62	Rev: D2 PCB_SGH Date: 6/4/2013
Sheet 8	of 11



Figure 24. JTAG and trace connectors



STMicroelectronics	
Title: STM3210E-EVAL JTAG & Trace	
Number: MB62	Rev: D2 PCB SCH Date: 6/4/2013
Sheet: 9	of 11



Figure 25. Power supply

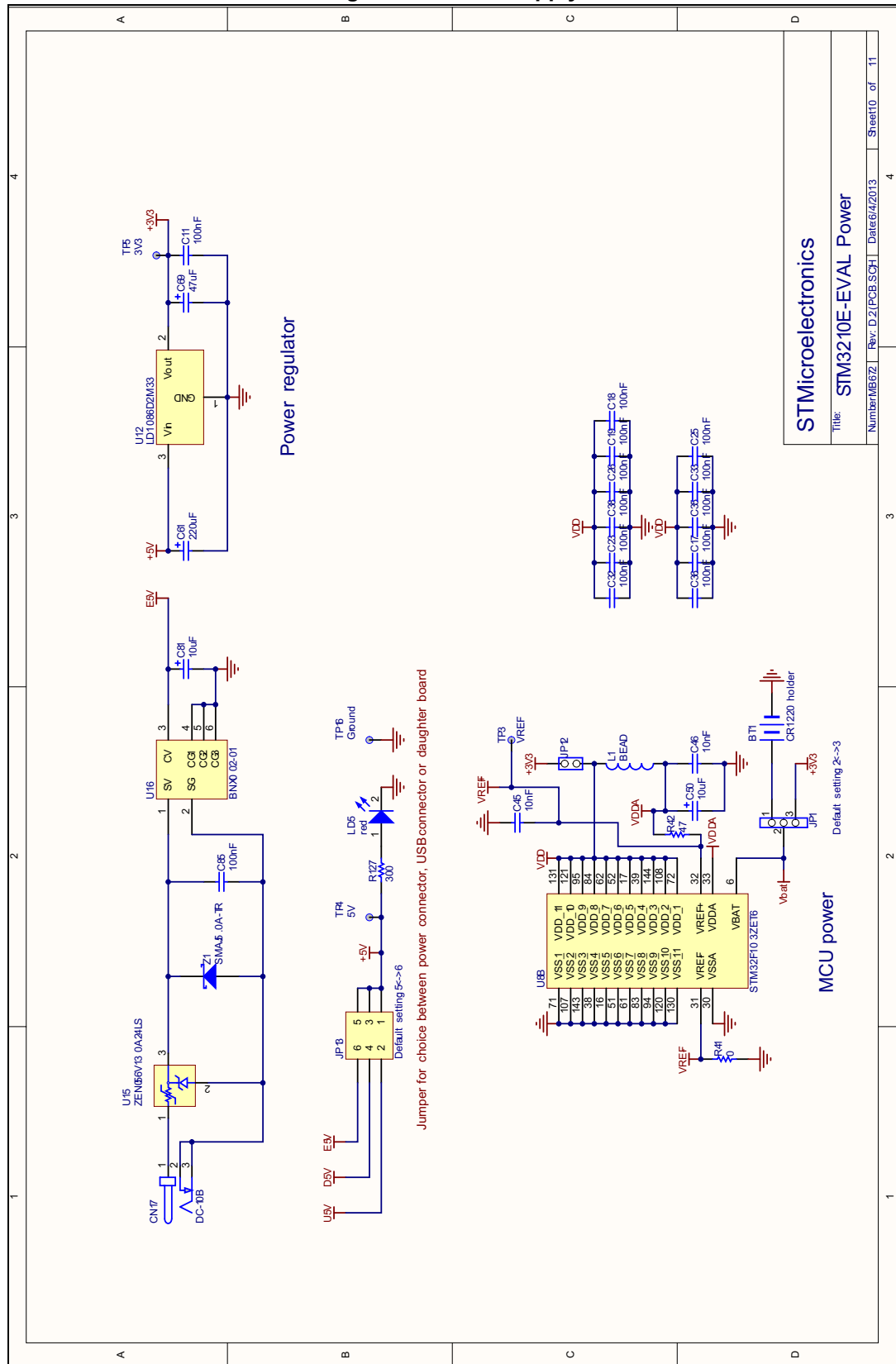
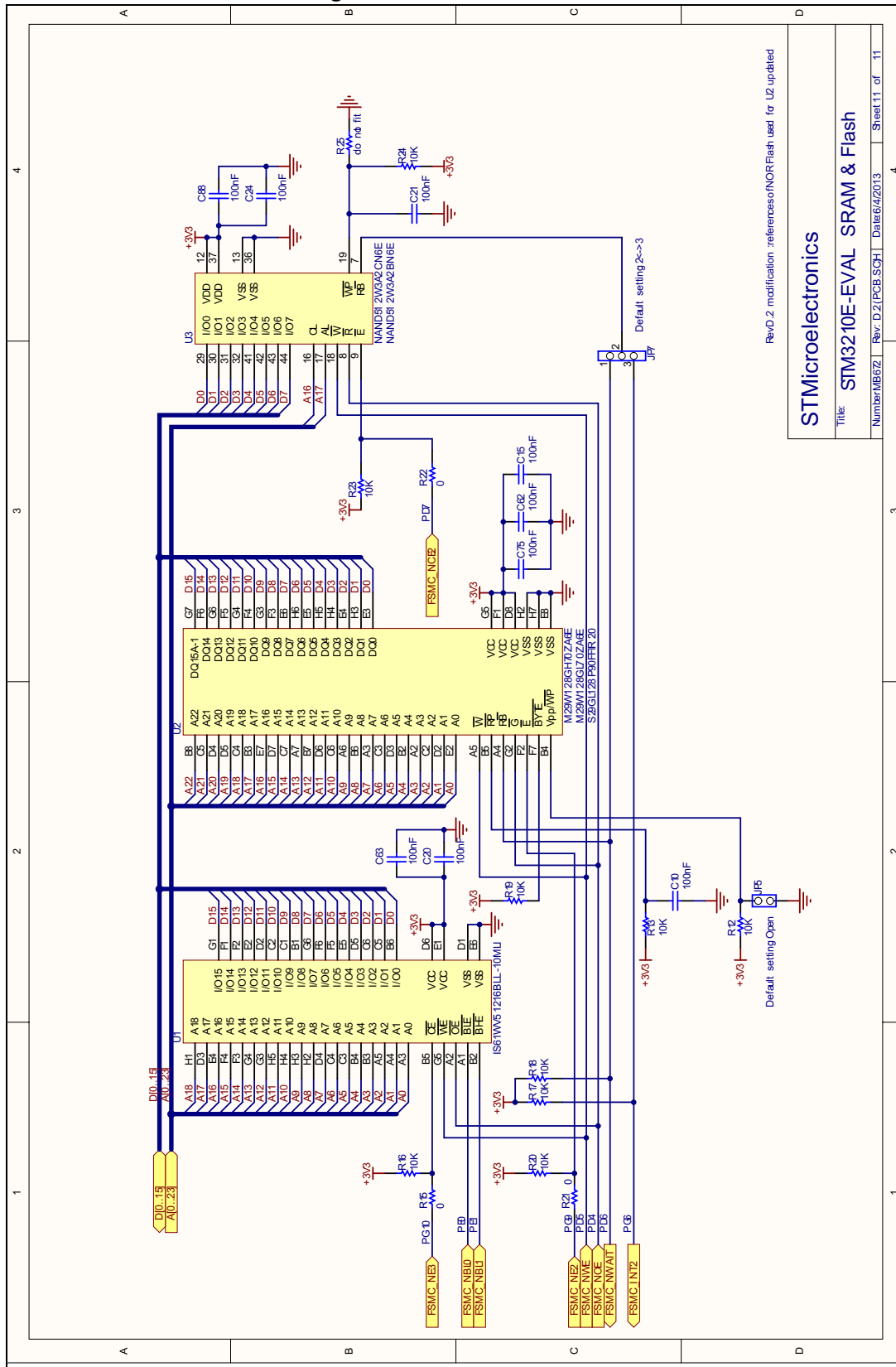


Figure 26. SRAM and Flash



Rev D.2 modification: references to NORFlash used for U2 updated

STMicroelectronics

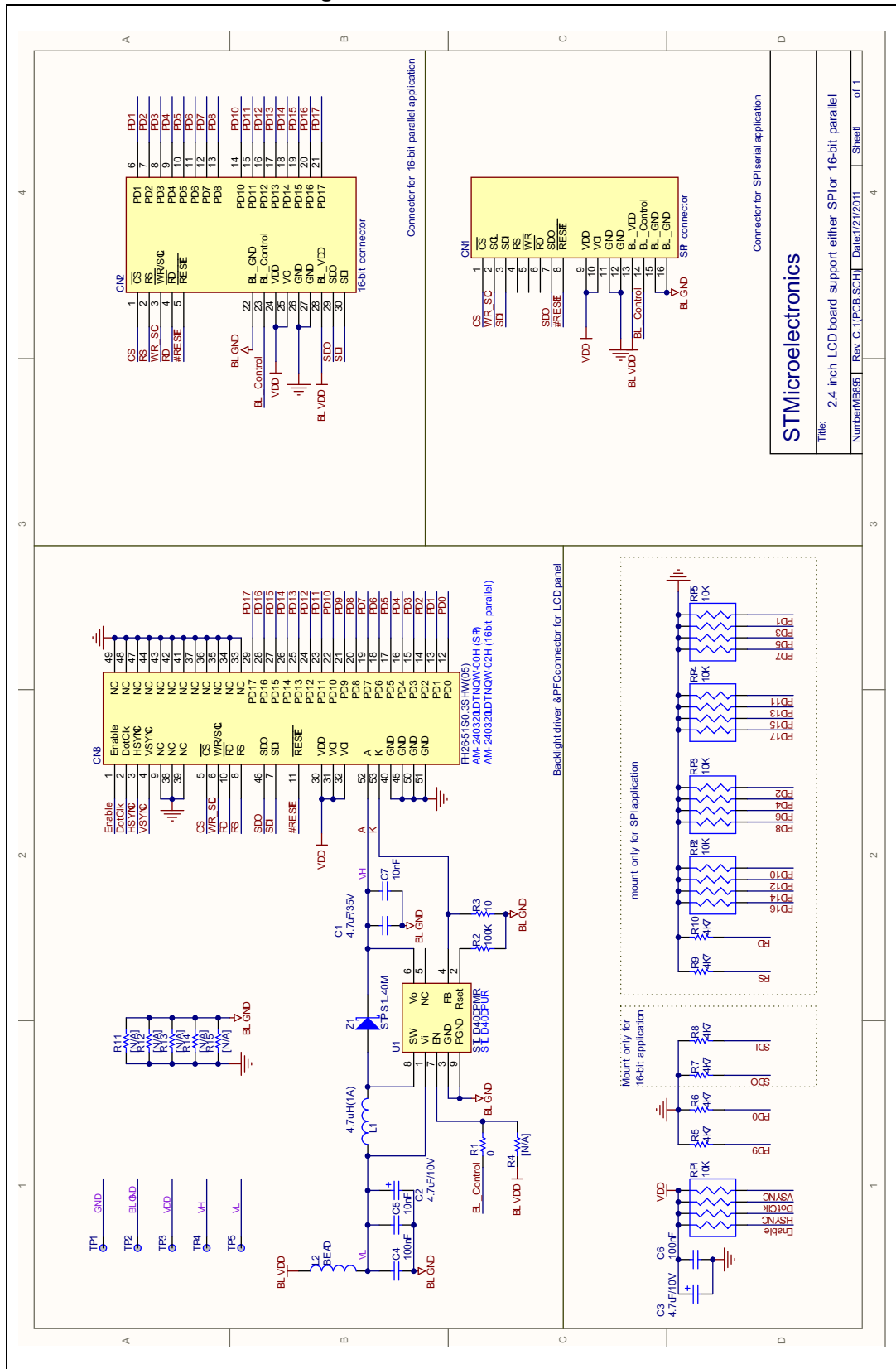
Title: STM3210E-EVAL SRAM & Flash

Number: MB67Z Rev: D.2 (PCB_SCH) Date: 6/4/2013

Sheet 11 of 11



Figure 27. Color LCD module



Appendix A STM3210E-EVAL I/O assignment

Table 29. STM3210E-EVAL I/O assignment

Pin #	Pin name	STM3210E-EVAL I/O assignment
1	PE2	Trace_CLK/FSMCA23
2	PE3	Trace_D0/FSMCA19
3	PE4	Trace_D1/FSMCA20
4	PE5	Trace_D2/FSMCA21
5	PE6	Trace_D3/FSMCA22
6	VBAT	+3V3 or battery
7	PC13-ANTI_TAMP	Anti-tamper button
8	PC14-OSC32_IN	32K OSC
9	PC15-OSC32_OUT	32K OSC
10	PF0	FSMCA0
11	PF1	FSMCA1
12	PF2	FSMCA2
13	PF3	FSMCA3
14	PF4	FSMCA4
15	PF5	FSMCA5
16	VSS_5	GND
17	VDD_5	+3V3
18	PF6	LD2
19	PF7	LD3
20	PF8	LD4
21	PF9	LD5
22	PF10	LCD_CS for graphic LCD (optional)
23	OSC_IN	8MHz crystal X1
24	OSC_OUT	8MHz crystal X1
25	NRST	Reset button B1
26	PC0	MC_ADC_123_10 pin14 (bus voltage)
27	PC1	MC_ADC11 pin 15 / BNC1
28	PC2	MC_ADC12 pin 17 / BNC2
29	PC3	MC_ADC13 pin 19 / BNC3
30	VSSA	GND
31	VREF-	GND
32	VREF+	+3V3

Table 29. STM3210E-EVAL I/O assignment (continued)

Pin #	Pin name	STM3210E-EVAL I/O assignment
33	VDDA	+3V3
34	PA0-WKUP	MC_TIM2_CH1 pin 31(Ena) / WAKEUP /USART2 CTS
35	PA1	MC_TIM2_CH2 pin 33 (EnB)/USART2 RTS
36	PA2	MC_TIM2_CH3 pin34 (EnIndex)/USART2 TX
37	PA3	MC_TIM6_CH4 pin 23 (dissipative brake)/USART2 RX
38	VSS_4	GND
39	VDD_4	+3V3
40	PA4	DAC1_Audio RIN
41	PA5	SPI_Flash_CLK / DAC2_Audio LIN / QST pin4
42	PA6	MC_STOP pin 1 (Emergency stop) / SPI_Flash_MISO / QST pin8
43	PA7	MC_TIM5_CH1N pin 5 (UL) / SPI_Flash_MOSI / QST pin6
44	PC4	Potentiometer
45	PC5	MC_ADC_12_15 pin 26 (heatsink temperature)
46	PB0	MC_TIM5_CH2N pin 9 (VL) / SmartCard_3/5
47	PB1	MC1_TIM5_CH3N pin 13 (WL) / QST pin7
48	PB2	Boot1/ NSS_SPI_Flash
49	PF11	QST pin9 / MicroSD Card detection
50	PF12	FSMCA6
51	VSS_6	GND
52	VDD_6	+3V3
53	PF13	FSMCA7
54	PF14	FSMCA8
55	PF15	FSMCA9
56	PG0	FSMCA10
57	PG1	FSMCA11
58	PE7	FSMCD4
59	PE8	FSMCD5
60	PE9	FSMCD6
61	VSS_7	GND
62	VDD_7	+3V3
63	PE10	FSMCD7
64	PE11	FSMCD8
65	PE12	FSMCD9
66	PE13	FSMCD10
67	PE14	FSMCD11

Table 29. STM3210E-EVAL I/O assignment (continued)

Pin #	Pin name	STM3210E-EVAL I/O assignment
68	PE15	FSMCD12
69	PB10	Smart_IO
70	PB11	Smart Reset
71	VSS_1	GND
72	VDD_1	+3V3
73	PB12	Smart_CK / MC_pin21 (NTC) / Audio I2S_CMD
74	PB13	Audio I2S_CK
75	PB14	USB Disconnect
76	PB15	Audio I2S_DIN
77	PD8	FSMCD13
78	PD9	FSMCD14
79	PD10	FSMCD15
80	PD11	FSMCA16
81	PD12	FSMCA17
82	PD13	FSMCA18
83	VSS_8	GND
84	VDD_8	+3V3
85	PD14	FSMCD0
86	PD15	FSMCD1
87	PG2	FSMCA12
88	PG3	FSMCA13
89	PG4	FSMCA14
90	PG5	FSMCA15
91	PG6	FSMC_INT2
92	PG7	JOY_Select
93	PG8	User Button B4
94	VSS_9	GND
95	VDD_9	+3V3
96	PC6	MC_TIM5_CH1 pin 3 (UH) / Smart_CMD / VCC/I2S_MCK
97	PC7	MC_TIM5_CH2 pin 7(VH) / Smartcard_OFF
98	PC8	MC_TIM5_CH3 pin 11 (WH) / MicroSD Card D0
99	PC9	MicroSD Card D1
100	PA8	MCO / LCD backlight /QST pin11
101	PA9	USART1 TX
102	PA10	USART1 RX

Table 29. STM3210E-EVAL I/O assignment (continued)

Pin #	Pin name	STM3210E-EVAL I/O assignment
103	PA11	USB DM
104	PA12	USB DP
105	PA13	Debug TMS
106	NC	
107	VSS_2	GND
108	VDD_2	+3V3
109	PA14	Debug TCK
110	PA15	Debug TDI
111	PC10	IRDA TX / MicroSD Card D2
112	PC11	IRDA RX /MicroSD Card D3
113	PC12	MicroSD Card CLK
114	PD0	FSMCD2
115	PD1	FSMCD3
116	PD2	Sd card CMD / MC1_TIM3_ETR pin 27 (PFCsync2)
117	PD3	JOY_Down
118	PD4	FSMCNOE
119	PD5	FSMCNWE
120	VSS_10	GND
121	VDD_10	+3V3
122	PD6	FSMCNWAIT
123	PD7	FSMCNE1
124	PG9	FSMCNE2
125	PG10	FSMCNE3
126	PG11	PDN of Audio DAC
127	PG12	FSMCEBAR3
128	PG13	JOY_Right
129	PG14	JOY_Left
130	VSS_11	GND
131	VDD_11	+3V3
132	PG15	JOY_Up
133	PB3	Debug TDO
134	PB4	Debug TRST/MC_TIM3_CH1 pin 27 (PFCsync1)
135	PB5	Temperature SMBIA / MC_TIM3_CH2 pin 29 (PFC pwm)/ QST pin10
136	PB6	Audio I2C_SCL & Temperature SCL / QST pin3
137	PB7	Audio_I2C_SDA & Temperature SDA / QST pin5

Table 29. STM3210E-EVAL I/O assignment (continued)

Pin #	Pin name	STM3210E-EVAL I/O assignment
138	BOOT0	BOOT0
139	PB8	CAN RX
140	PB9	CAN TX
141	PE0	FSMCBLN0
142	PE1	FSMCBLN1
143	VSS_3	GND
144	VDD_3	+3V3

Revision history

Table 30. Document revision history

Date	Revision	Changes
5-May-2008	1	Initial release.
2-Jun-2008	2	Added information on NOR Flash references in Section 2.20 . Updated schematics in Section 4 .
20-Nov-2008	3	Modified cover page. Inserted a new Chapter 1 . Modified bank specified in Section 2.17 , Section 2.18 , Section 2.19 and Section 2.20 .
21-Jan-2010	4	Modified bank specified in Section 2.19 . Modified LCD in Section 3.13 and Figure 27 .
01-Jul-2010	5	Replaced STM32F103Z with STM32F103ZGT6. 64 KB internal SRAM and 512 KB Flash replaced with 96 KB internal SRAM and 1 MB Flash.
12-Aug-2013	6	Replaced schematics.

Please Read Carefully:

Information in this document is provided solely in connection with ST products. STMicroelectronics NV and its subsidiaries ("ST") reserve the right to make changes, corrections, modifications or improvements, to this document, and the products and services described herein at any time, without notice.

All ST products are sold pursuant to ST's terms and conditions of sale.

Purchasers are solely responsible for the choice, selection and use of the ST products and services described herein, and ST assumes no liability whatsoever relating to the choice, selection or use of the ST products and services described herein.

No license, express or implied, by estoppel or otherwise, to any intellectual property rights is granted under this document. If any part of this document refers to any third party products or services it shall not be deemed a license grant by ST for the use of such third party products or services, or any intellectual property contained therein or considered as a warranty covering the use in any manner whatsoever of such third party products or services or any intellectual property contained therein.

UNLESS OTHERWISE SET FORTH IN ST'S TERMS AND CONDITIONS OF SALE ST DISCLAIMS ANY EXPRESS OR IMPLIED WARRANTY WITH RESPECT TO THE USE AND/OR SALE OF ST PRODUCTS INCLUDING WITHOUT LIMITATION IMPLIED WARRANTIES OF MERCHANTABILITY, FITNESS FOR A PARTICULAR PURPOSE (AND THEIR EQUIVALENTS UNDER THE LAWS OF ANY JURISDICTION), OR INFRINGEMENT OF ANY PATENT, COPYRIGHT OR OTHER INTELLECTUAL PROPERTY RIGHT.

ST PRODUCTS ARE NOT AUTHORIZED FOR USE IN WEAPONS. NOR ARE ST PRODUCTS DESIGNED OR AUTHORIZED FOR USE IN: (A) SAFETY CRITICAL APPLICATIONS SUCH AS LIFE SUPPORTING, ACTIVE IMPLANTED DEVICES OR SYSTEMS WITH PRODUCT FUNCTIONAL SAFETY REQUIREMENTS; (B) AERONAUTIC APPLICATIONS; (C) AUTOMOTIVE APPLICATIONS OR ENVIRONMENTS, AND/OR (D) AEROSPACE APPLICATIONS OR ENVIRONMENTS. WHERE ST PRODUCTS ARE NOT DESIGNED FOR SUCH USE, THE PURCHASER SHALL USE PRODUCTS AT PURCHASER'S SOLE RISK, EVEN IF ST HAS BEEN INFORMED IN WRITING OF SUCH USAGE, UNLESS A PRODUCT IS EXPRESSLY DESIGNATED BY ST AS BEING INTENDED FOR "AUTOMOTIVE, AUTOMOTIVE SAFETY OR MEDICAL" INDUSTRY DOMAINS ACCORDING TO ST PRODUCT DESIGN SPECIFICATIONS. PRODUCTS FORMALLY ESCC, QML OR JAN QUALIFIED ARE DEEMED SUITABLE FOR USE IN AEROSPACE BY THE CORRESPONDING GOVERNMENTAL AGENCY.

Resale of ST products with provisions different from the statements and/or technical features set forth in this document shall immediately void any warranty granted by ST for the ST product or service described herein and shall not create or extend in any manner whatsoever, any liability of ST.

ST and the ST logo are trademarks or registered trademarks of ST in various countries.

Information in this document supersedes and replaces all information previously supplied.

The ST logo is a registered trademark of STMicroelectronics. All other names are the property of their respective owners.

© 2013 STMicroelectronics - All rights reserved

STMicroelectronics group of companies

Australia - Belgium - Brazil - Canada - China - Czech Republic - Finland - France - Germany - Hong Kong - India - Israel - Italy - Japan - Malaysia - Malta - Morocco - Philippines - Singapore - Spain - Sweden - Switzerland - United Kingdom - United States of America

www.st.com