

1 2 3 4 5 6

A

B

C

D

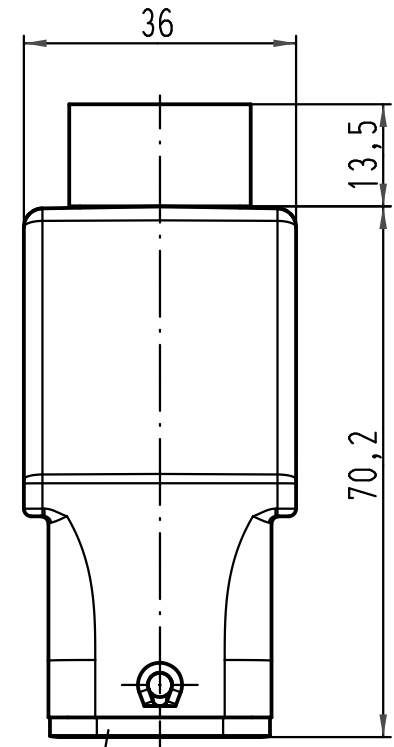
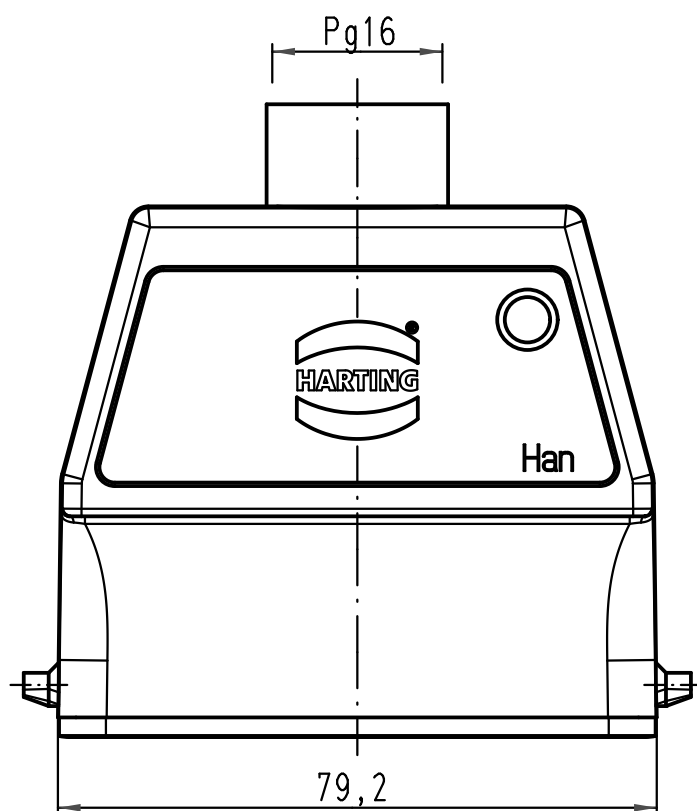

Dichtung
seal

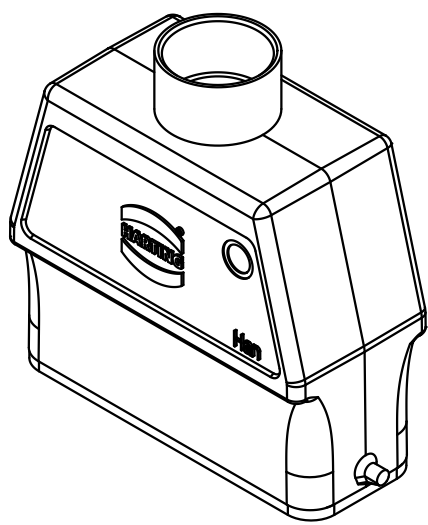

All Dimensions in mm Original Size DIN A 4			Techn. Character.			Nicht tolerierte Maß/Free size tolerances			
				Dat.	Name	Maßstab/Scale 1:1	Han 16A-gg-16 Gehäuse/hood		
			Detail.	09.04.10	Ho				
			Insp.		Tie				
			Stand.						
A			HARTING Electric GmbH & Co. KG				TB 09 20 016 0440		
Mod.	Dat.	Name	D-32339 Espelkamp						
							Sub. TB 09 20 016 0440 v. 23.04.99		Blatt/page