

# DC-DC Converter DATA Sheet

## MPDTY311S/MPDTY312S

### 1. Features

These are the Low Voltage/High current non-insulated type DC-DC converter.  
 Low profile ; 4.2mmMAX.  
 Output voltage is adjustable by using single external resistance.  
 (0.8-3.3V : MPDTY311S    0.8-2.5V : MPDTY312S )  
 ON/OFF function is built in.  
 Short circuit protection & over temperature protection is built in.

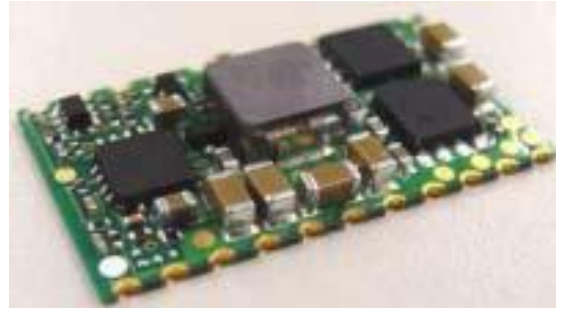

### Product line up

Input Voltage	
5.0V type	3.3V type
MPDTY311S	MPDTY312S

### 2. Appearance, Dimensions

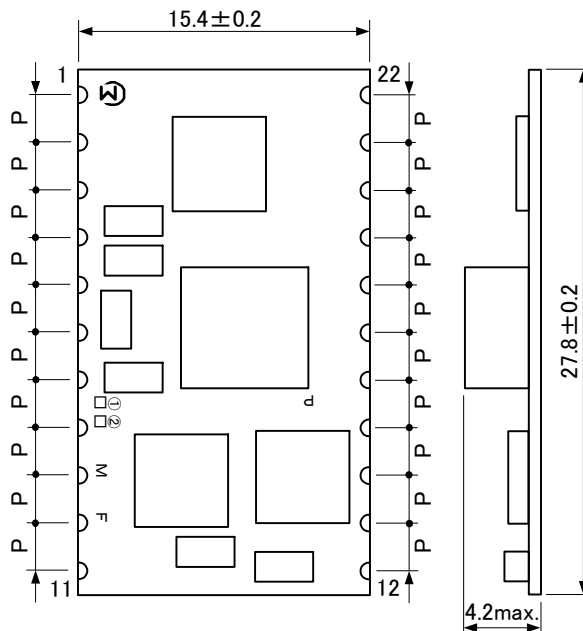

P=2.54 ±0.3mm

Tolerance is not accumulated.

【Unit : mm】

### Marking

(1) Pin No.1 Marking / MFG ID (M)  
 (2) Parts No. RN  
 (3) Lot No. □□  
                   ①②

① Production Year

② Production Month (1,2,3,···9,O,N,D)

### Pin Number and Function

Pin No.	Symbol	Function
1,2,3,4,5	Vout	Output
6,7,8,9,10, 18,19,20,21	GND	GND
11	VAR	Output voltage adjustment
12	ON/OFF	Remote ON/OFF
13,14,15,16,17	Vin	Input
22	N.C.	This pin must be left open.

### ⚠ Note:

- This datasheet is downloaded from the website of Murata Manufacturing co., Ltd. Therefore, it's specifications are subject to change or our products in it may be discontinued without advance notice. Please check with our sales representatives or product engineers before ordering.
- This datasheet has only typical specifications because there is no space for detailed specifications. Therefore, please approve our product specifications or transact the approval sheet for product specifications before ordering.

### 3. Block Diagram

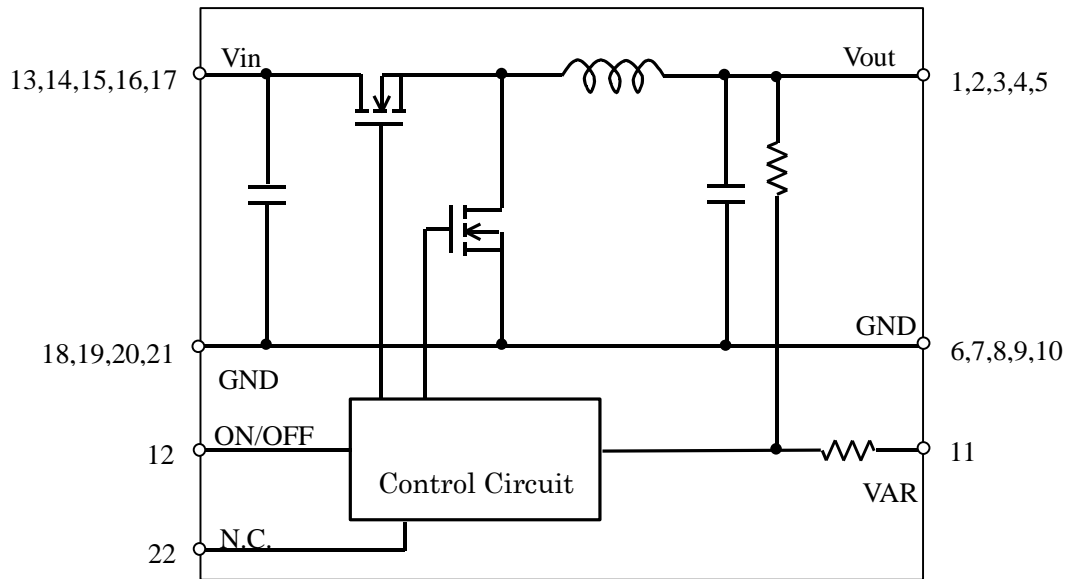

### 4. Environmental Conditions

4.1 Operating Temperature Range	-40 °C ~ +85 °C
4.2 Storage Temperature Range	-45 °C ~ +90 °C
4.3 Operating Humidity Range	20% ~ 85%(No water condenses in any cases.) Maximum wet-bulb temperature 39 °C
4.4 Storage Humidity Range	10% ~ 90%(No water condenses in any cases.) Maximum wet-bulb temperature 39 °C

### 5. Absolute Rating

Item	Unit	Absolute Rating	Remarks
Minimum Input Voltage	V	0	
Maximum Input Voltage	MPDTY311S	V	5.5
	MPDTY312S	V	3.6
VAR,ON/OFF Pin Voltage	V	Vin+0.3	

※No voltage, no matter how instantaneous, shall be applied beyond the absolute maximum voltage rating to this product. If you apply any voltage over this limit the product characteristics will deteriorate or the product itself will be destroyed. Even though it may continue operating for a while after the over-voltage event, its life will likely be shortened significantly. Reliability and life of the module may degrade similarly if the maximum operating voltage rating is continuously exceeded. This product is designed to operate within the maximum operating voltage rating specification.

#### ⚠ Note:

- This datasheet is downloaded from the website of Murata Manufacturing co., Ltd. Therefore, it's specifications are subject to change or our products in it may be discontinued without advance notice. Please check with our sales representatives or product engineers before ordering.
- This datasheet has only typical specifications because there is no space for detailed specifications. Therefore, please approve our product specifications or transact the approval sheet for product specifications before ordering.

2010.12.20

## 6. Characteristics

## 6.1 Electrical Characteristics (Ta=25 °C)

Item	Symbol	Condition	Model Number	Value			Unit
				Min.	Typ.	Max.	
Input Voltage	Vin		MPDXY311S	4.5	5.0	5.5	V
			MPDXY312S	3.0	3.3	3.6	
UVLO Threshold	UVLO		MPDXY311S	4.0	4.3	4.5	V
			MPDXY312S	2.7	2.9	3.0	
Output Voltage Adjustable Range	Vout		MPDXY311S	0.8	-	3.3	V
			MPDXY312S	0.8	-	2.5	
Output Voltage Accuracy	Vout-0.8	Vin =4.5~5.5V, Iout= 0~16A VAR= Open, ON/OFF= Open	MPDXY311S	0.776	0.80	0.824	V
	Vout-3.3	Vin =4.5~5.5V, Iout= 0~16A VAR= 560Ω, ON/OFF= Open		3.201	3.30	3.399	
	Vout-0.8	Vin =3.0~3.6V, Iout= 0~16A VAR= Open, ON/OFF= Open	MPDXY312S	0.776	0.80	0.824	
	Vout-2.5	Vin =3.0~3.6V, Iout= 0~16A VAR= 510Ω, ON/OFF= Open		2.425	2.50	2.575	
Output Current	Iout	See the thermal derating curve in clause 6.2.	All	0	-	16.0	A
Ripple Voltage	Vripl	Vin =5.0V, Iout=16A, BW=20MHz	MPDXY311S	-	15	50	mV(p_p)
		Vin =3.3V, Iout=16A, BW=20MHz	MPDXY312S				
Efficiency	EFF	Vin =5.0V, Vout=3.3V, Iout= 16A	MPDXY311S	88	92	-	%
		Vin =3.3V, Vout=2.5V, Iout= 16A	MPDXY312S	87.5	91.5	-	
Operating Frequency	Frq		All	-	600	-	kHz
ON/OFF pin High Voltage	VIH	ON/OFF pin is pulled up to Vin inside of the DC-DC Converter. If ON/OFF pin is left open, the DC-DC Converter shall be "ON". This pin will be pulled down to GND inside the DC-DC Converter when OCP or OTP events occur. Please do NOT connect this pin to Vin with low impedance line, so as not to damage the converter.					
ON/OFF pin Low Voltage	VIL	If ON/OFF pin is pulled down to GND, the DC-DC Converter shall be "OFF".		0	-	0.3	V
Short Circuit Protection	SCP	If output is shorted to GND , DC-DC Converter shall be operated in a hiccup mode. After the short circuit event has cleared, the output is automatically brought back into regulation.					
Over Temperature Protection	OTP	If OTP event is occurred, DC-DC Converter shall be shut down. After the OTP event has cleared, the output is automatically brought back into regulation.		-	115	-	°C
Additional Output Capacitor	Cout	When input voltage is ideal voltage source		0	-	1000	μF
Output Delay	Td	Output voltage 0-10% (remote on)		0.1	-	8	msec
Output Rise Time	Tr	Output voltage 10-90%		1	-	10	msec

 **Note:**

1. This datasheet is downloaded from the website of Murata Manufacturing co., Ltd. Therefore, it's specifications are subject to change or our products in it may be discontinued without advance notice. Please check with our sales representatives or product engineers before ordering.
2. This datasheet has only typical specifications because there is no space for detailed specifications. Therefore, please approve our product specifications or transact the approval sheet for product specifications before ordering.

2010.12.20

## 6. 2 Output Current Derating

This DC-DC Converter can output current in the condition of below temperature de-rating, when mounted on 101.6 mm×180 mm×1.6mm PCB.

But when there is any adjacent part of high temperature, the converter may be over heated.

Please confirm that the inductor temperature is below 106°C, and the MOSFETs are below 120°C for reliable operation.

### Thermal Derating (MPD TY311S)

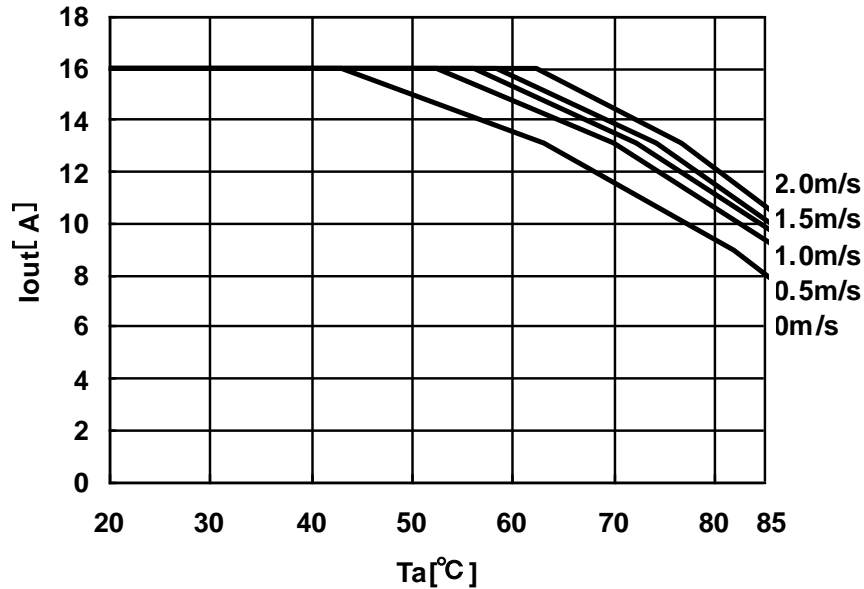

### Thermal Derating (MPD TY312S)

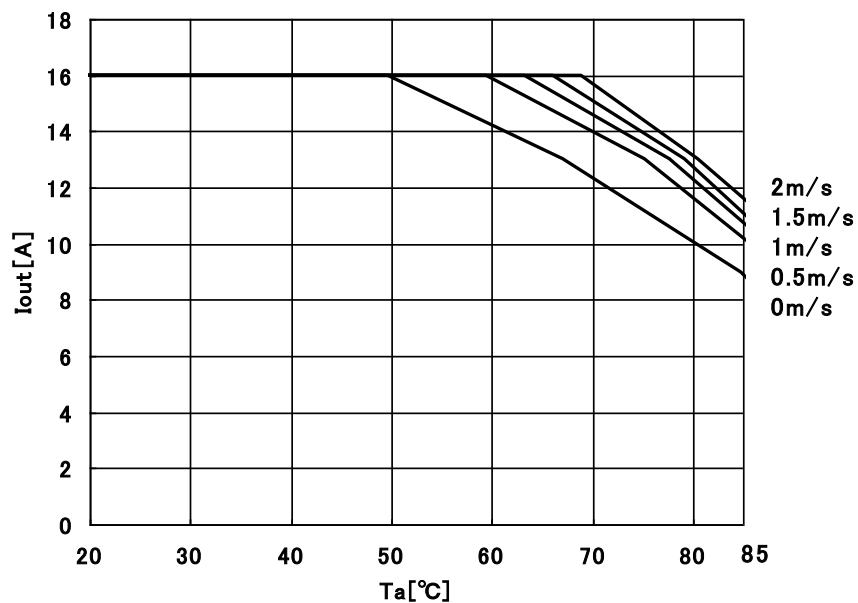

#### Note:

1. This datasheet is downloaded from the website of Murata Manufacturing co., Ltd. Therefore, it's specifications are subject to change or our products in it may be discontinued without advance notice. Please check with our sales representatives or product engineers before ordering.
2. This datasheet has only typical specifications because there is no space for detailed specifications. Therefore, please approve our product specifications or transact the approval sheet for product specifications before ordering.

## 7. Operation in information

## 7.1 Output Voltage Adjustment

0.8V~3.3V (MPDXY311S), 0.8V~2.5V (MPDXY312S)

The output voltage can be adjusted ranging by connecting resistors between VAR-pin(11pin) to GND-pin.  
The following equation gives the required external-resistor value to adjust the output voltage to Voadj.

It is strictly recommended to evaluate the characteristics of DC-DC Converter at your board conditions.

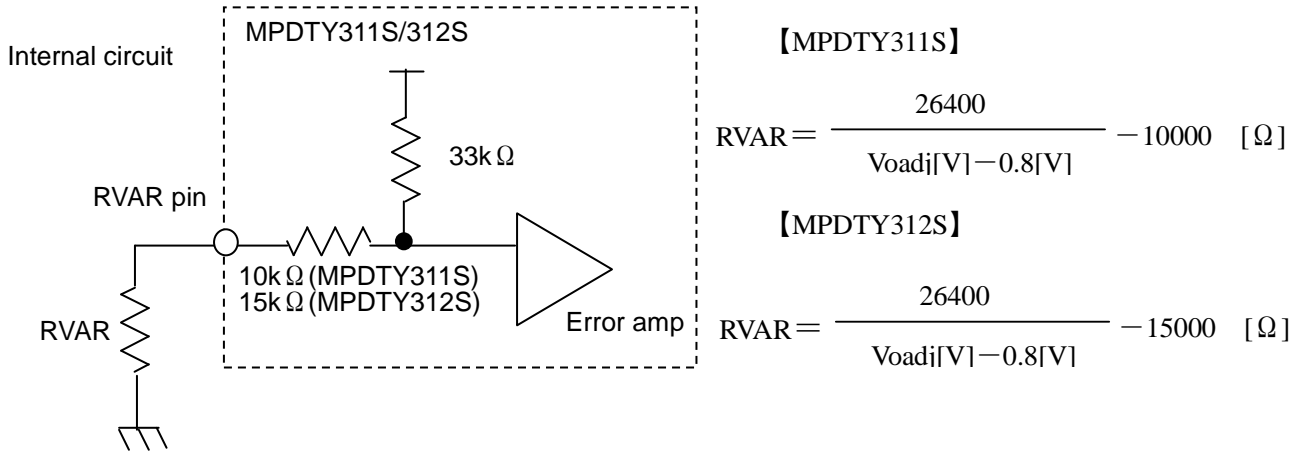

&lt; RVAR calculation example &gt;

【MPDXY311S】

Voadj [V]	Calculated RVAR[Ω]	RVAR example
3.3	560	560Ω
2.5	5529.4	5.1kΩ + 430Ω
2.0	12000	12kΩ
1.8	16400	16kΩ + 390Ω
1.5	27714.3	27kΩ + 680Ω
1.2	56000	56kΩ
1.0	122000	120kΩ + 2kΩ
0.8	∞	Open

【MPDXY312S】

Voadj [V]	Calculated RVAR[Ω]	RVAR example
2.5	529.4	510Ω
2.0	7000	6.8kΩ + 200Ω
1.8	11400	11kΩ + 390Ω
1.5	22714	22kΩ + 680Ω
1.2	51000	51kΩ
1.0	117000	100kΩ + 18kΩ
0.8	∞	Open

## ⚠ Note:

1. This datasheet is downloaded from the website of Murata Manufacturing co., Ltd. Therefore, it's specifications are subject to change or our products in it may be discontinued without advance notice. Please check with our sales representatives or product engineers before ordering.
2. This datasheet has only typical specifications because there is no space for detailed specifications. Therefore, please approve our product specifications or transact the approval sheet for product specifications before ordering.

2010.12.20

## 7.2 ON/OFF control

### ON/OFF function

The DC-DC Converter can be inactive by using ON/OFF function.

This function is effective when the sequence of a power supply system is constituted.

And it can be used for power-saving control.

In case of not using ON/OFF function

In case of not using ON/OFF function, please left open ON/OFF-pin(12pin).

If ON/OFF pin is connected to Vin with low impedance line, OCP and OTP shall be inactive.

### ON/OFF control method

Between ON/OFF-pin(12pin) and GND-pin

Open.....Output Voltage=ON

Short.....Output Voltage=OFF

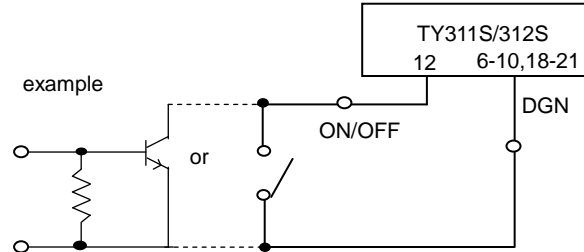

## 7.3. External output bias condition

External bias voltage level.

Less than  $V_{oadj}$

External bias current level.

Less than DC 32A

External output bias measurement condition

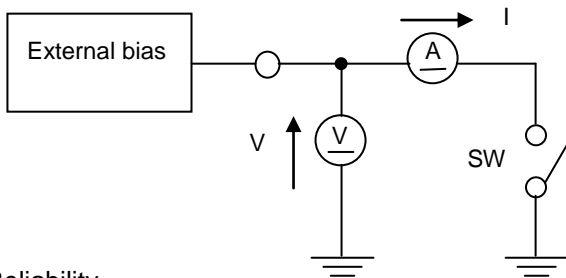

External bias voltage shall be measured when SW left open.

External bias current shall be measured when SW left short.

## 8. Reliability

### 8.1 Humidity

According to JIS-C-0022.

$40 \pm 2^\circ\text{C}$ , 90 to 95%RH, 100 hours. Leave for 4 hours at room temperature.

No damage in appearance and no deviation from electrical characteristics (section 6.1.).

### 8.2 Temperature Cycles

Repeat cycle 5 times. Leave 2 hours at room temp.

No damage in appearance and no deviation from electrical characteristics (section 6.1.).

Step	Condition	Time
1	$-40^\circ\text{C} \pm 3^\circ\text{C}$	30 minutes
2	Room Temp.	5-10 minutes
3	$+85^\circ\text{C} \pm 2^\circ\text{C}$	30 minutes
4	Room Temp.	5-10 minutes

### 8.3 Vibration

10 to 55Hz, 1.5mm amplitude (1minute cycle), 1 hour for each of X, Y, Z directions.

No damage in appearance and no deviation from electrical characteristics (section 6.1.).

### 8.4 Mechanical Shock

20G, 1 time for each X, Y, Z directions.

No damage in appearance and no deviation from electrical characteristics (section 6.1.).

### Note:

1. This datasheet is downloaded from the website of Murata Manufacturing co., Ltd. Therefore, it's specifications are subject to change or our products in it may be discontinued without advance notice. Please check with our sales representatives or product engineers before ordering.
2. This datasheet has only typical specifications because there is no space for detailed specifications. Therefore, please approve our product specifications or transact the approval sheet for product specifications before ordering.

## 9. Test Circuit

In the following test circuit, the initial values under item 6.1. should be met.

### 9.1. General Measure Circuit

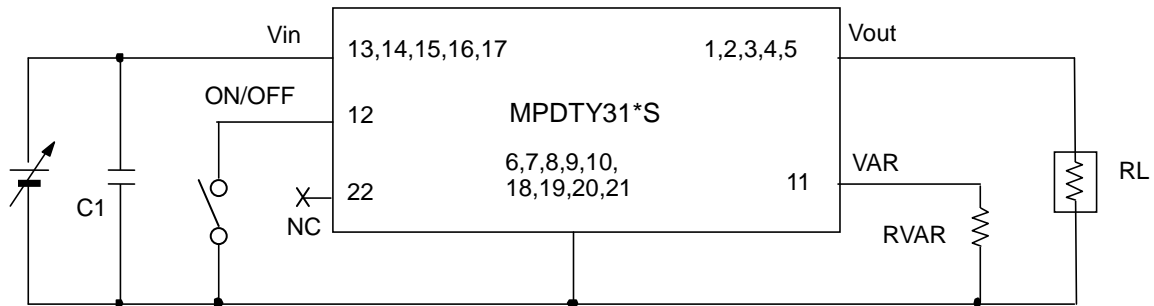

C1:100 $\mu$ F/6.3V (Ceramic Capacitor)

※ Pin 22 must be left open and should not be connected other pins.

### 9.2. Ripple Voltage Measurement Circuit

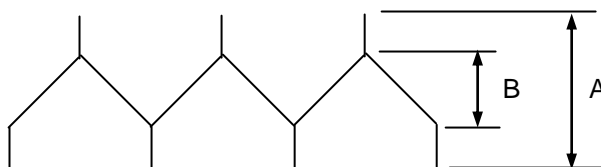
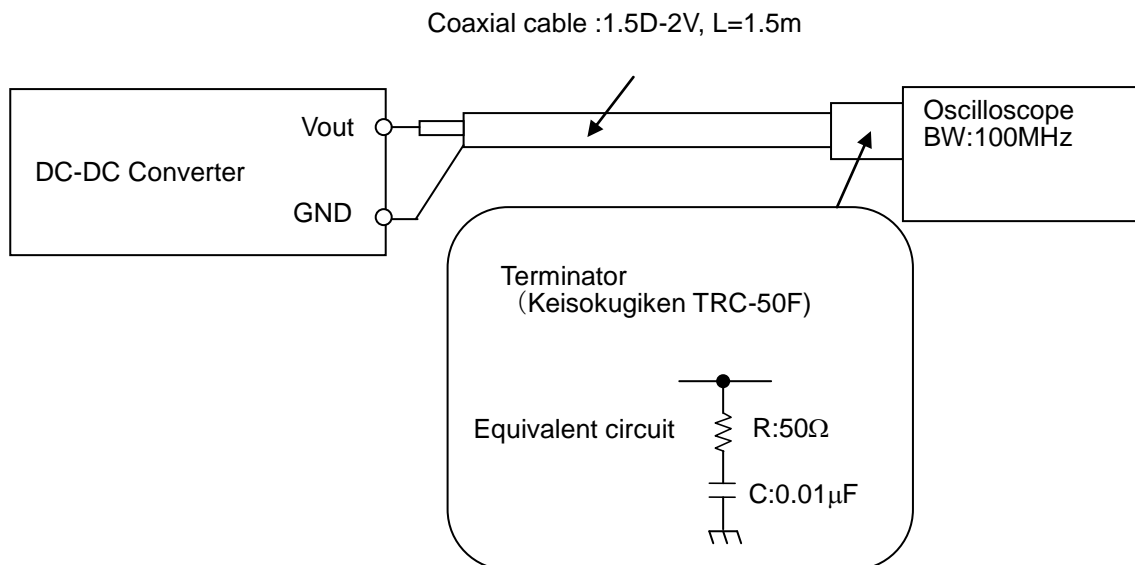

A : Output Ripple Noise  
B : Output Ripple Voltage

#### ⚠ Note:

1. This datasheet is downloaded from the website of Murata Manufacturing co., Ltd. Therefore, it's specifications are subject to change or our products in it may be discontinued without advance notice. Please check with our sales representatives or product engineers before ordering.
2. This datasheet has only typical specifications because there is no space for detailed specifications. Therefore, please approve our product specifications or transact the approval sheet for product specifications before ordering.

## 10. Packaging Specification

### 10.1. Emboss Tape Dimensions

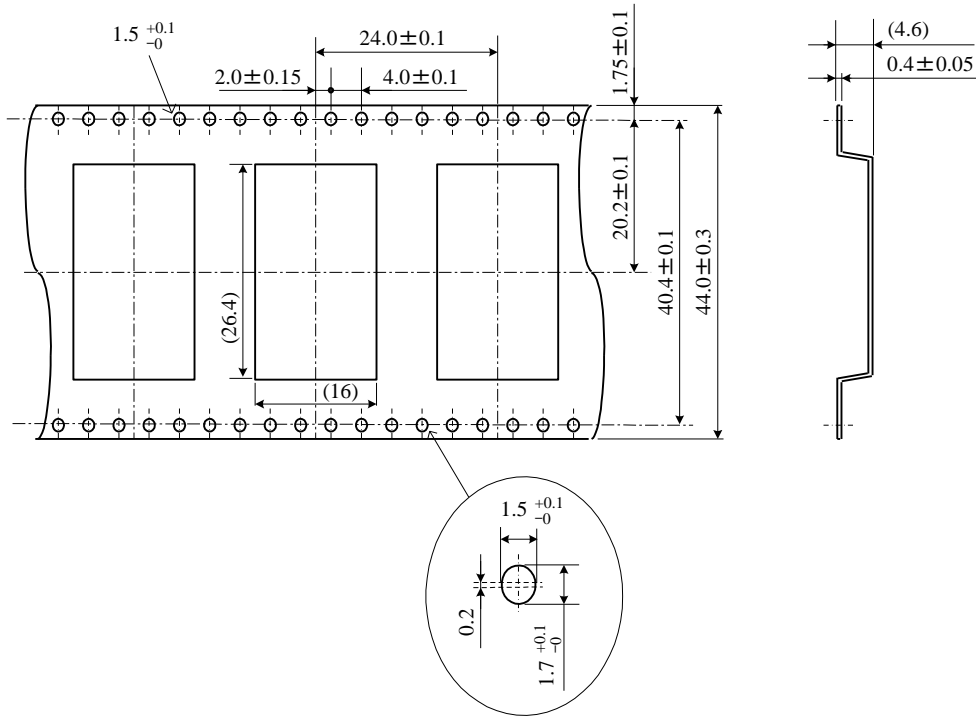

### 10.2. Real Dimensions

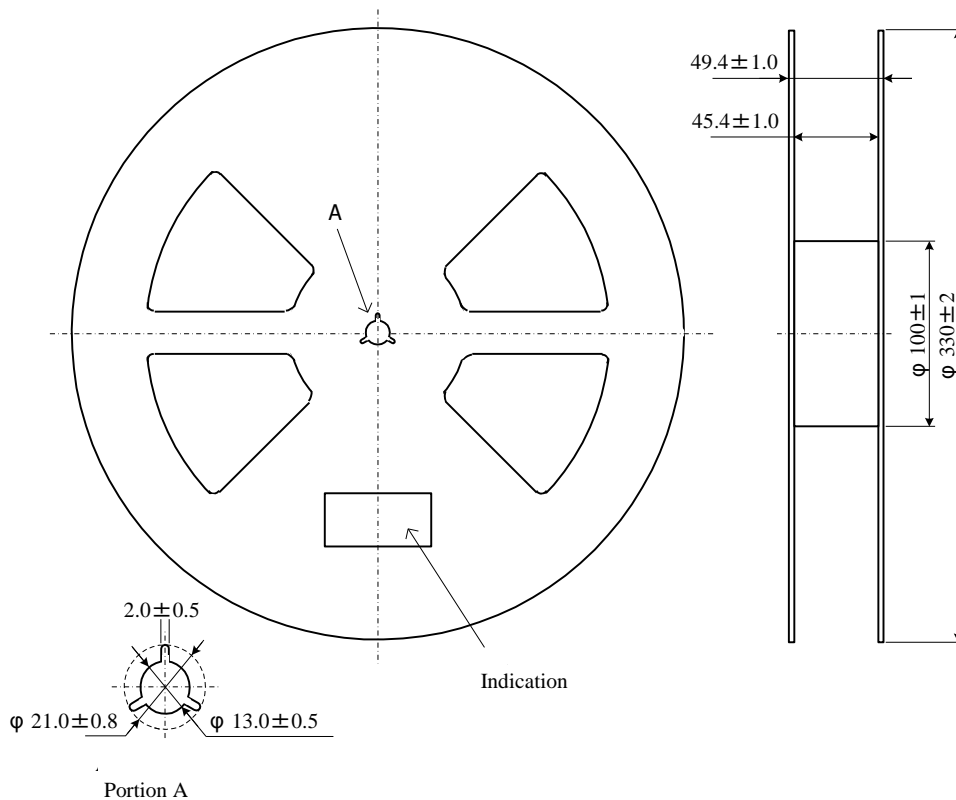

#### **Note:**

1. This datasheet is downloaded from the website of Murata Manufacturing co., Ltd. Therefore, it's specifications are subject to change or our products in it may be discontinued without advance notice. Please check with our sales representatives or product engineers before ordering.
2. This datasheet has only typical specifications because there is no space for detailed specifications. Therefore, please approve our product specifications or transact the approval sheet for product specifications before ordering.



### 10.3. Taping Specification

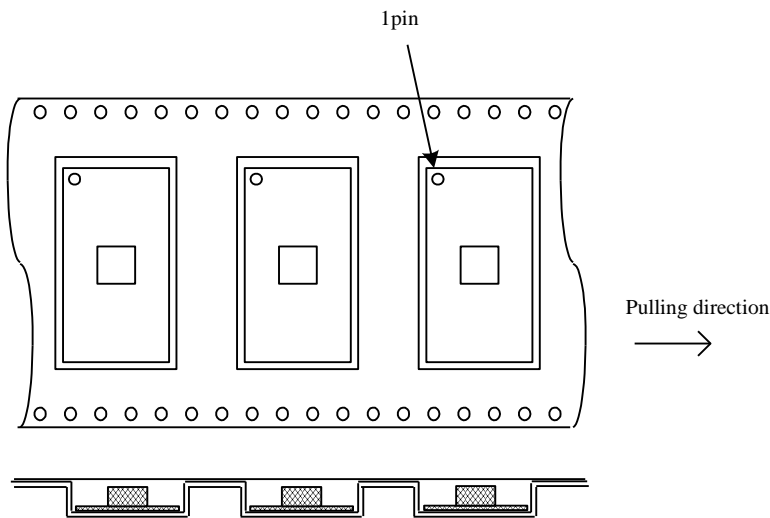
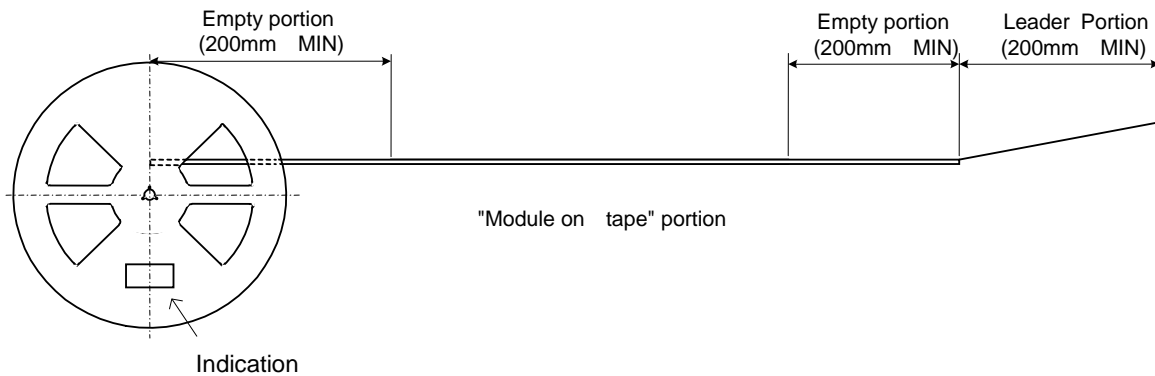

The module is located such as parts in upper side and PCB in lower side.

### 10.4. Note

1. The adhesive strength of the protective tape must be within 0.1-1N.
2. Each reel contains 300pcs.
3. The deficiency per reel is 0 piece.
4. The reel shows customer part number, Murata part number and quantity.
5. The color of reel is not designated.

### 11. Production factory

Komatsu Murata Mfg.Co., Ltd.  
 Kanazu Murata Mfg. Co., Ltd.  
 Wakura Murata Mfg. Co., Ltd.

#### Note:

1. This datasheet is downloaded from the website of Murata Manufacturing co., Ltd. Therefore, it's specifications are subject to change or our products in it may be discontinued without advance notice. Please check with our sales representatives or product engineers before ordering.
2. This datasheet has only typical specifications because there is no space for detailed specifications. Therefore, please approve our product specifications or transact the approval sheet for product specifications before ordering.

## 12. Characteristics Data

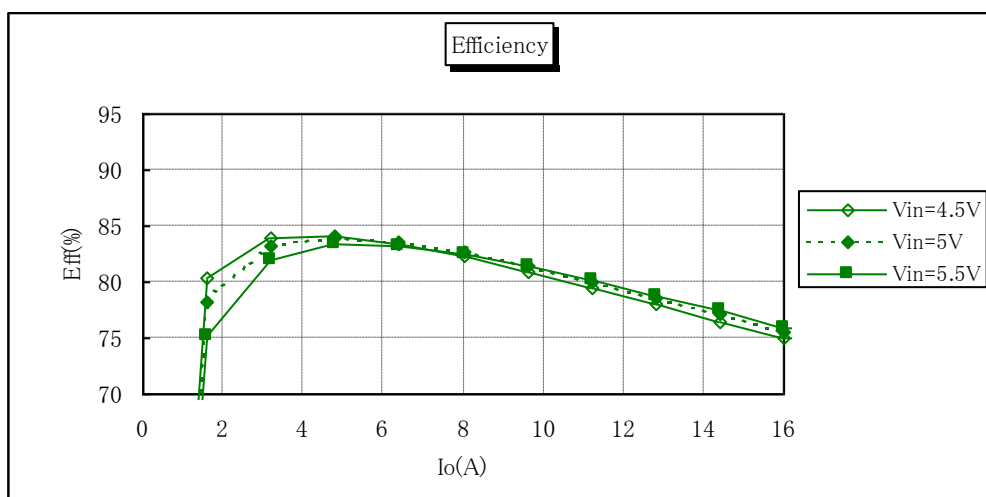
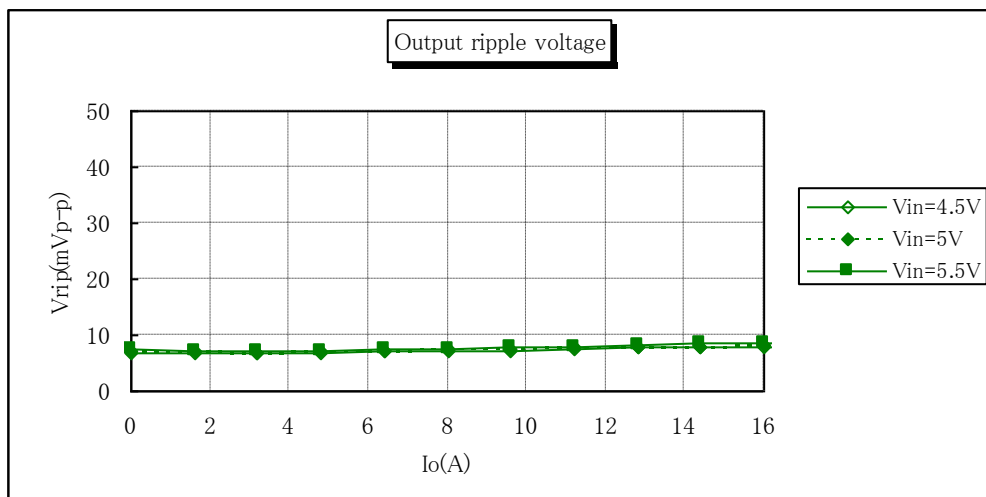
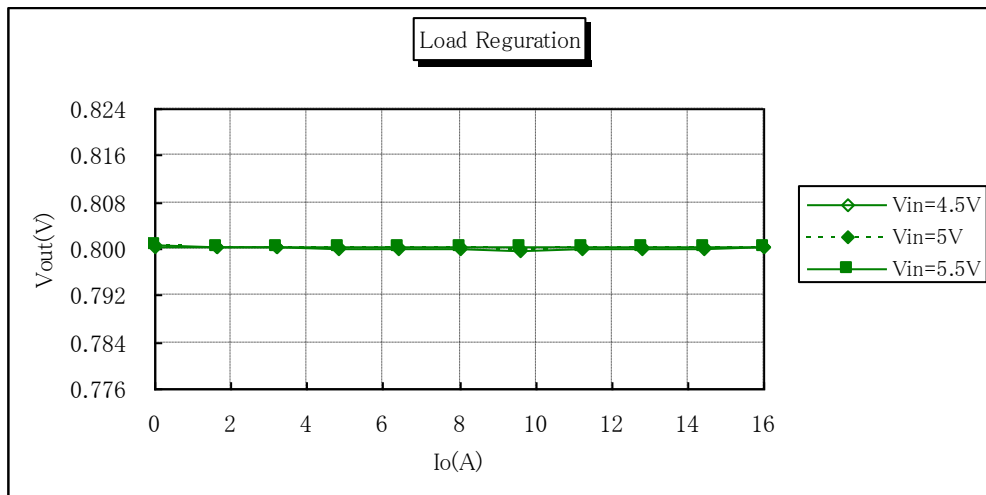
12.1 MPDXY311S ( $V_{out}=0.8V$ )

**Note:**

1. This datasheet is downloaded from the website of Murata Manufacturing co., Ltd. Therefore, it's specifications are subject to change or our products in it may be discontinued without advance notice. Please check with our sales representatives or product engineers before ordering.
2. This datasheet has only typical specifications because there is no space for detailed specifications. Therefore, please approve our product specifications or transact the approval sheet for product specifications before ordering.

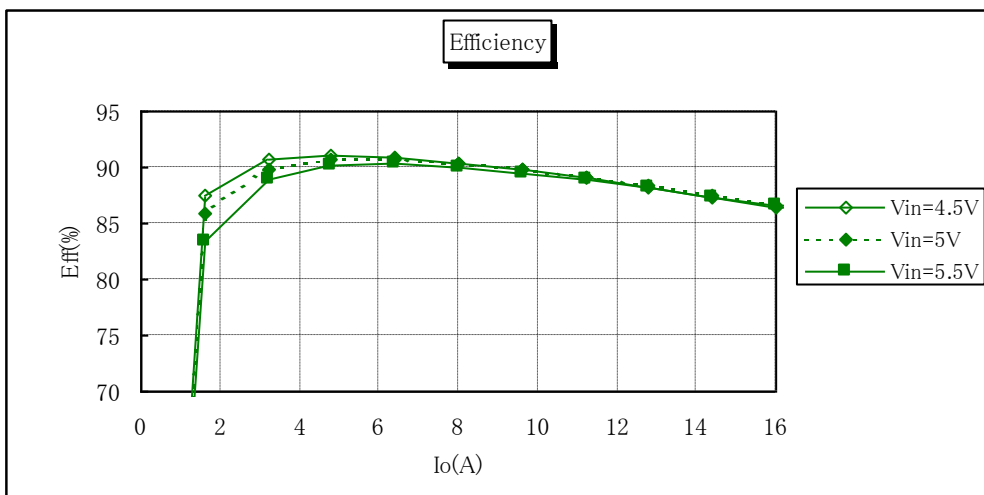
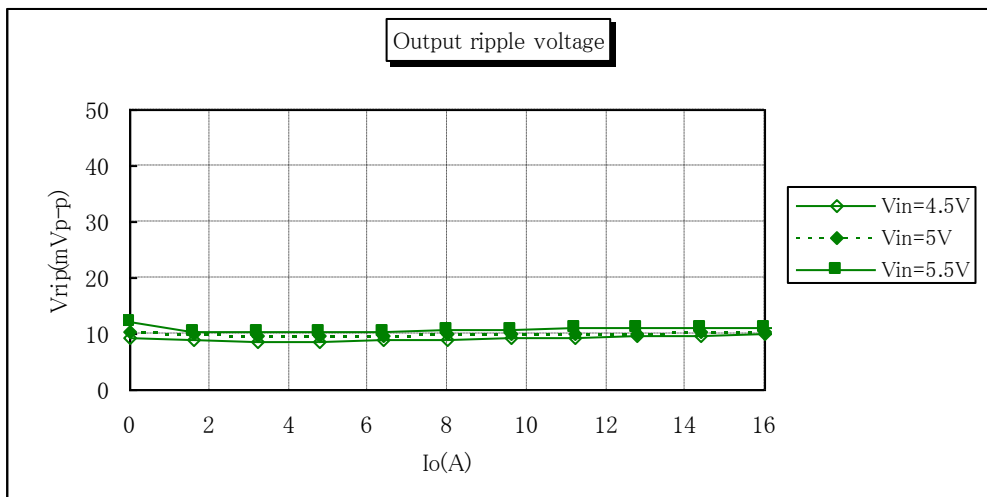
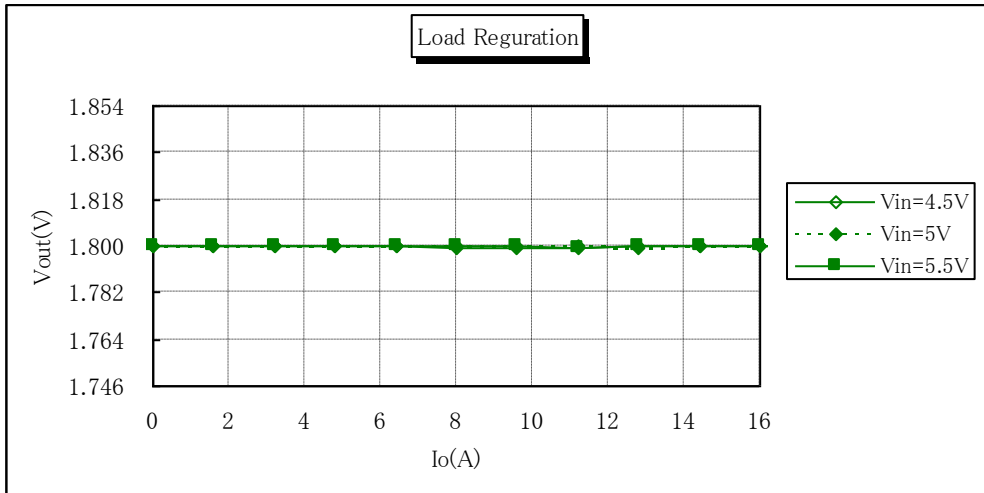
12.2 MPDTY311S ( $V_{out}=1.8V$ )

**Note:**

1. This datasheet is downloaded from the website of Murata Manufacturing co., Ltd. Therefore, it's specifications are subject to change or our products in it may be discontinued without advance notice. Please check with our sales representatives or product engineers before ordering.
2. This datasheet has only typical specifications because there is no space for detailed specifications. Therefore, please approve our product specifications or transact the approval sheet for product specifications before ordering.

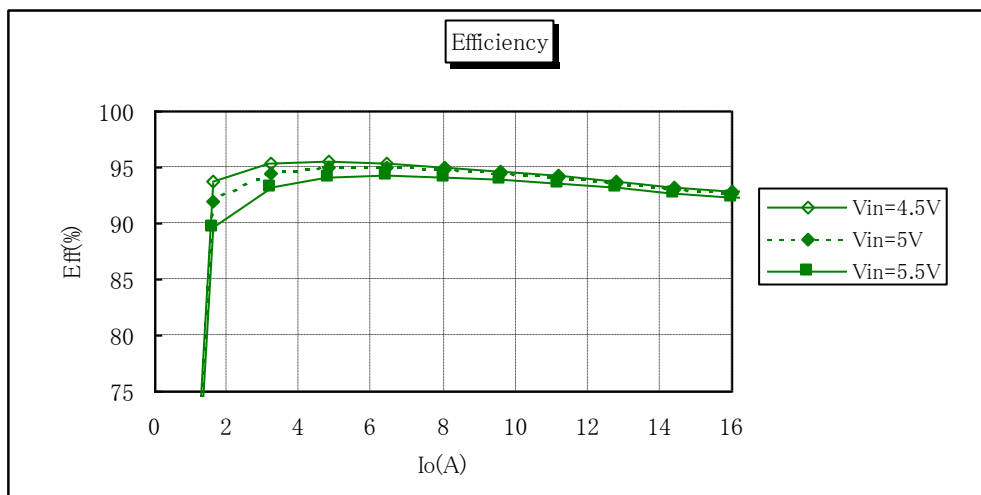
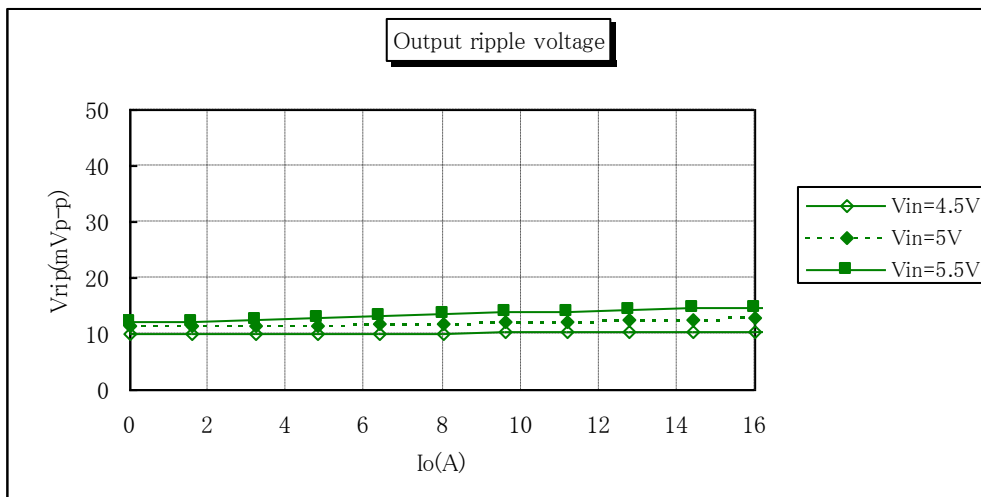
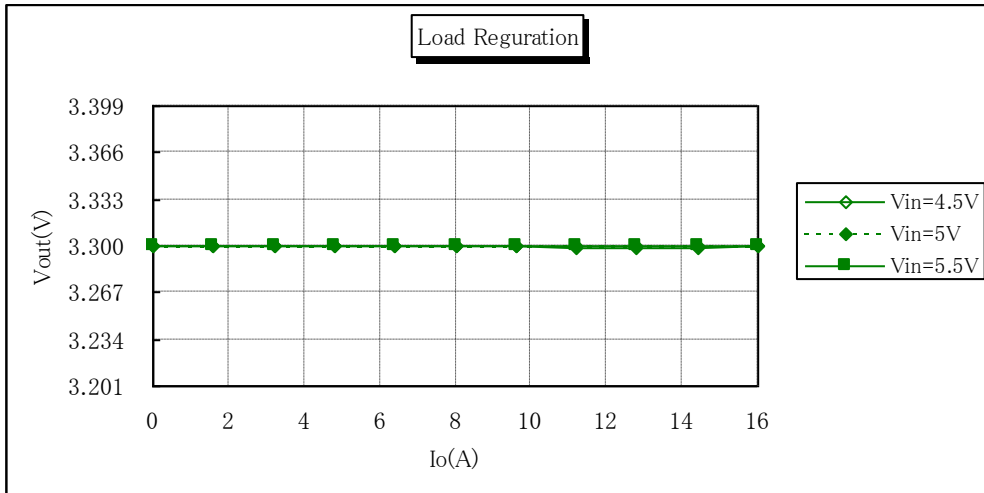
12.3 MPDTY311S ( $V_{out}=3.3V$ )

**Note:**

1. This datasheet is downloaded from the website of Murata Manufacturing co., Ltd. Therefore, it's specifications are subject to change or our products in it may be discontinued without advance notice. Please check with our sales representatives or product engineers before ordering.
2. This datasheet has only typical specifications because there is no space for detailed specifications. Therefore, please approve our product specifications or transact the approval sheet for product specifications before ordering.

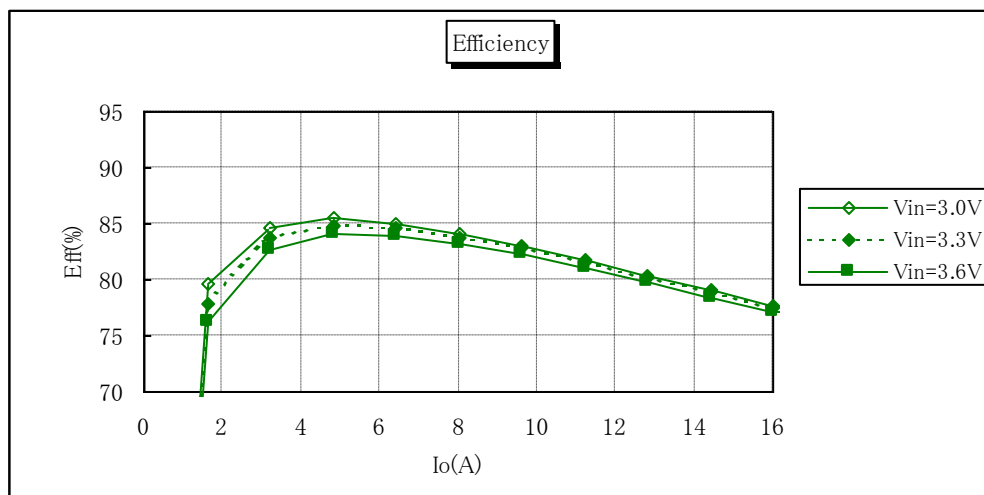
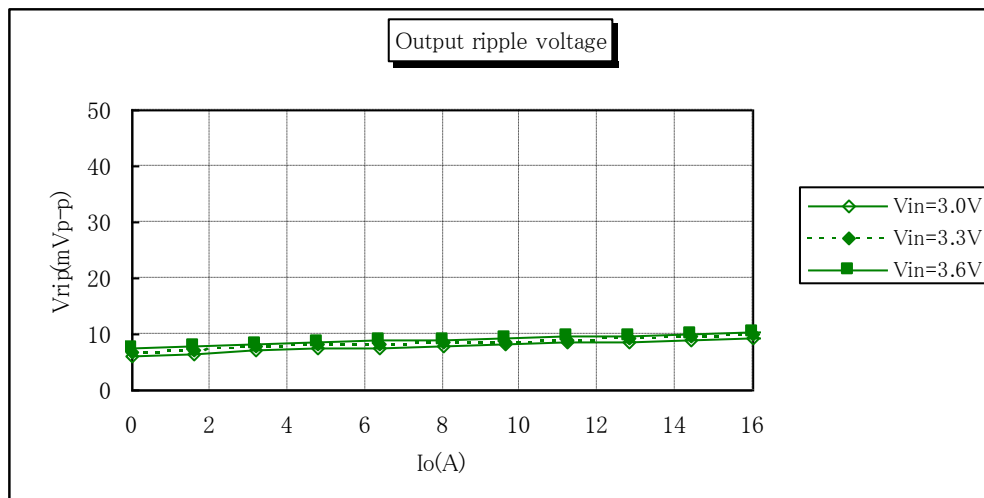
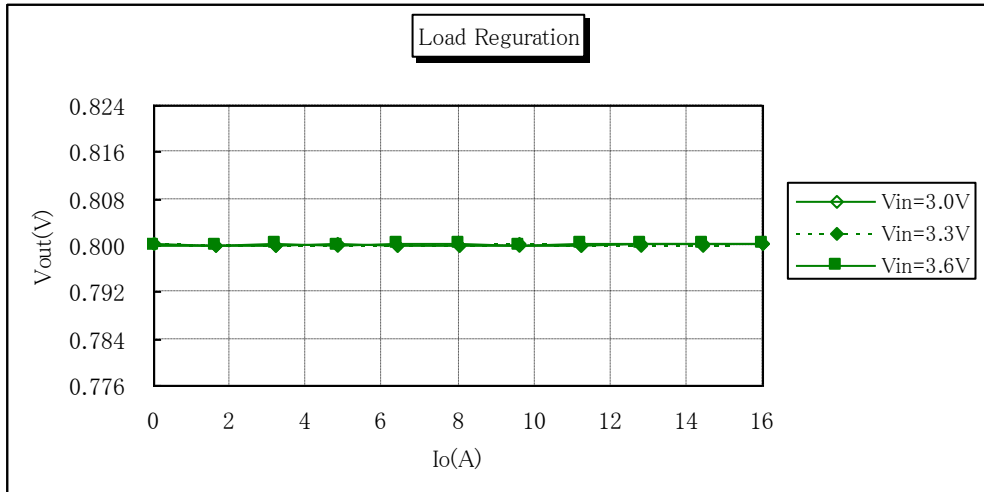
12.4 MPDTY312S ( $V_{out}=0.8V$ )

**Note:**

1. This datasheet is downloaded from the website of Murata Manufacturing co., Ltd. Therefore, it's specifications are subject to change or our products in it may be discontinued without advance notice. Please check with our sales representatives or product engineers before ordering.
2. This datasheet has only typical specifications because there is no space for detailed specifications. Therefore, please approve our product specifications or transact the approval sheet for product specifications before ordering.

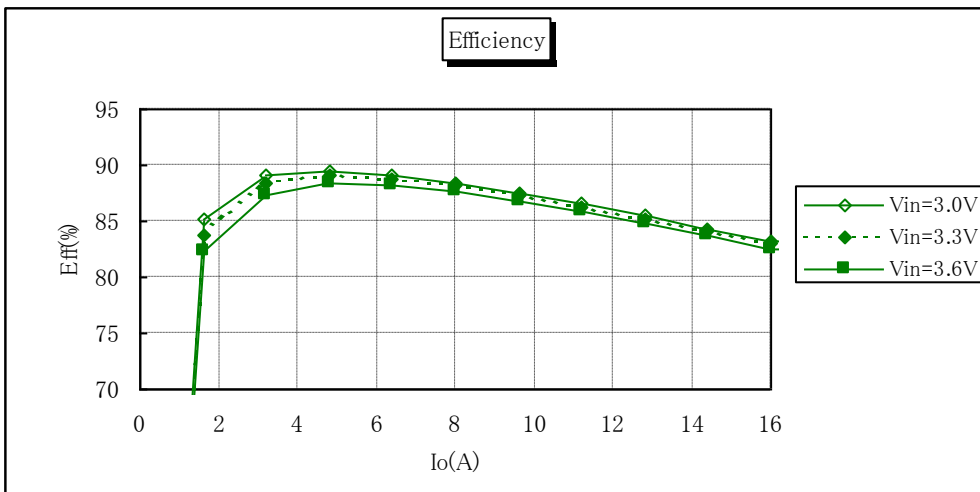
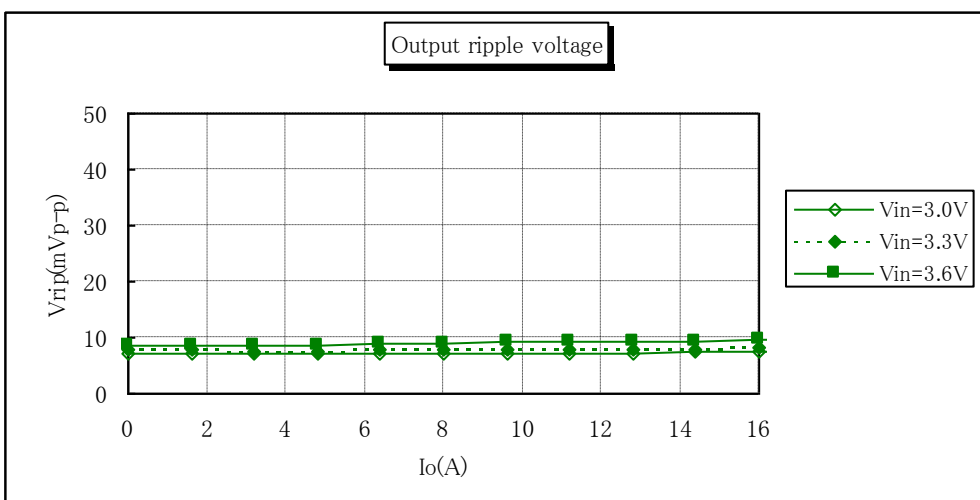
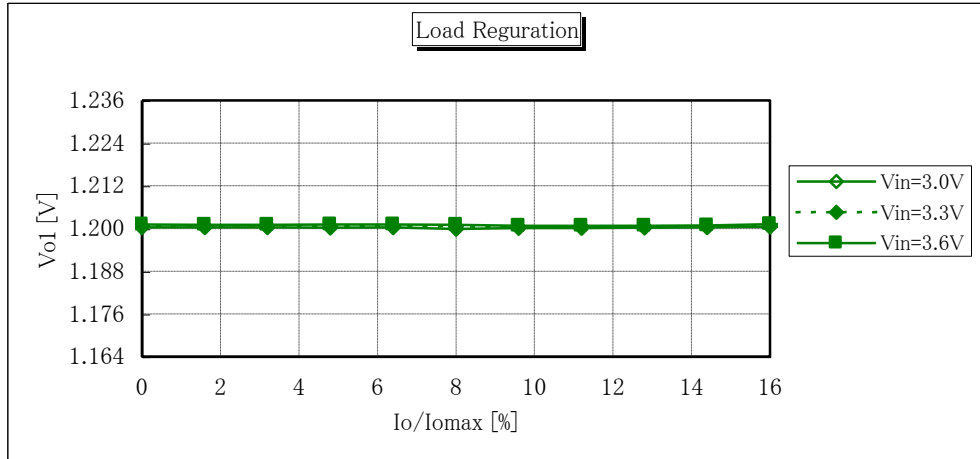
12.5 MPDTY312S ( $V_{out}=1.2V$ )

**Note:**

1. This datasheet is downloaded from the website of Murata Manufacturing co., Ltd. Therefore, it's specifications are subject to change or our products in it may be discontinued without advance notice. Please check with our sales representatives or product engineers before ordering.
2. This datasheet has only typical specifications because there is no space for detailed specifications. Therefore, please approve our product specifications or transact the approval sheet for product specifications before ordering.

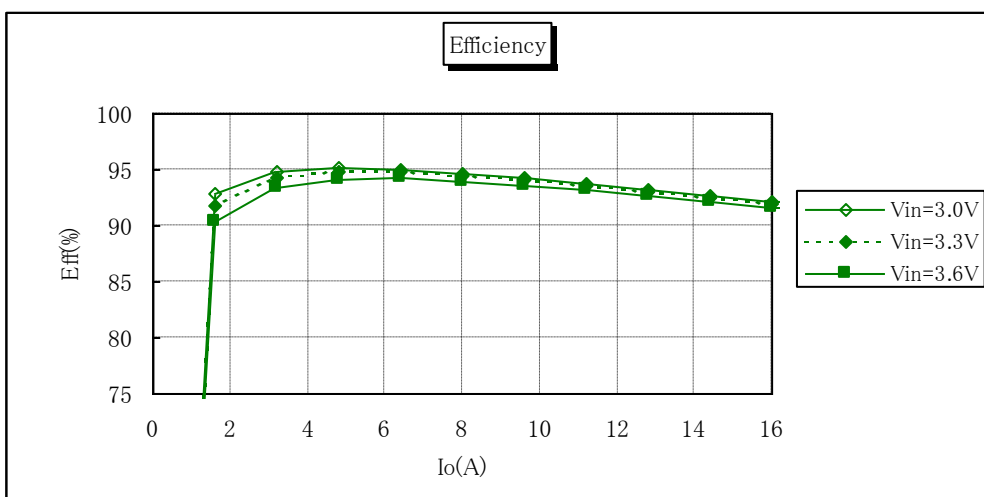
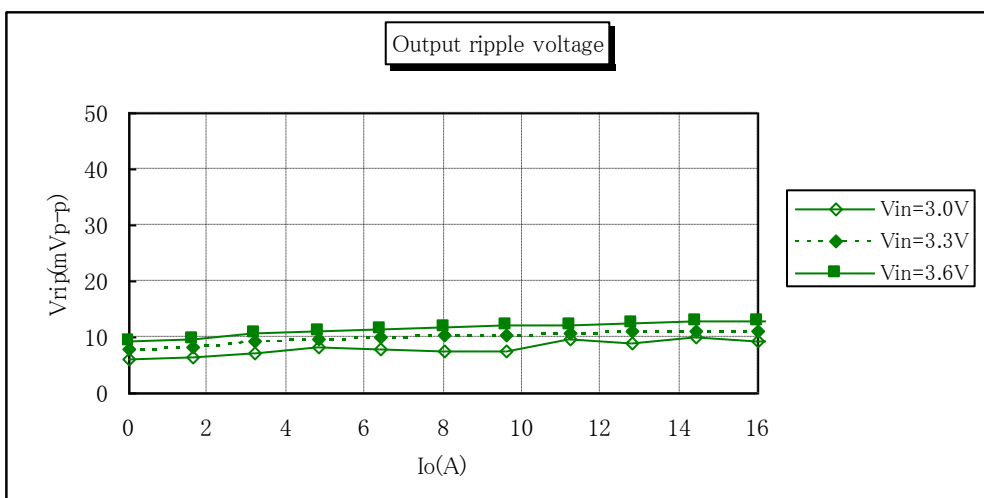
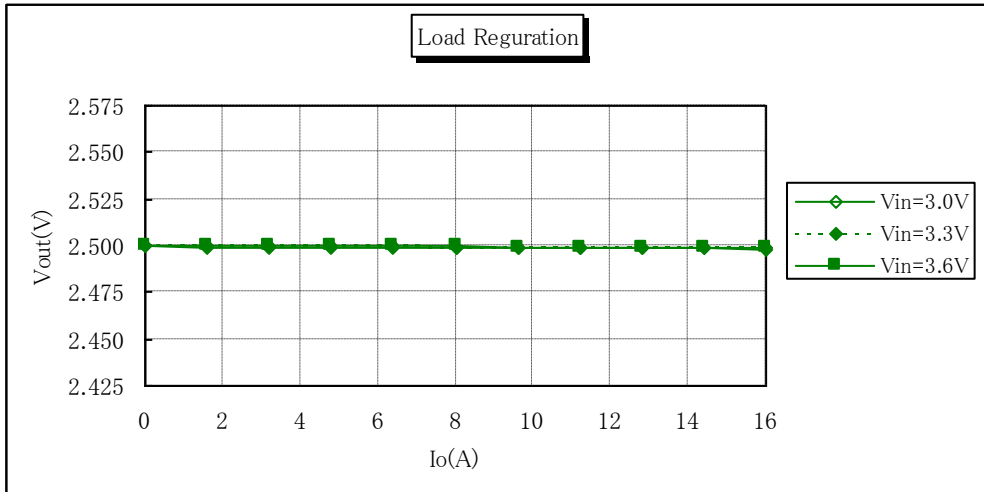
12.6 MPDXY312S ( $V_{out}=2.5V$ )

**Note:**

1. This datasheet is downloaded from the website of Murata Manufacturing co., Ltd. Therefore, it's specifications are subject to change or our products in it may be discontinued without advance notice. Please check with our sales representatives or product engineers before ordering.
2. This datasheet has only typical specifications because there is no space for detailed specifications. Therefore, please approve our product specifications or transact the approval sheet for product specifications before ordering.

## 13. Mounting Condition

## 13.1. PCB Land Pattern Recommendation

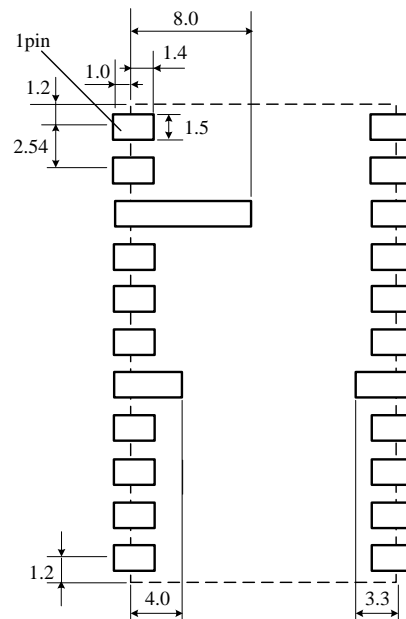

There are wiring coppers or through-hole via at the bottom side of the DC-DC converter. When you design your PCBs, please be careful not to short the circuit of the DC-DC converter or PCBs.

## 13.2. Recommendable Condition of Soldering

This product is RoHS compatible. The following profile is recommended for the reflow of this product using Pb-free solder paste (Sn-Ag-Cu).

Method : Full convection reflow soldering

Reflow Soldering Profile  
JEDEC IPC/JEDEC J-STD-020C  
Table 5-2 Classification Reflow Profile  
Pb-Free Assembly Large Body

## Profile details

Soldering temperature	: 245 °C +0/-5 °C
Soldering time	: 20 to 40 seconds, 240 to 245 °C
Heating time	: 60 to 150 seconds, over 217 °C
Preheating time	: 60 to 180 seconds, 150 to 200 °C
Programming rate	: 3 °C / sec. Max., 217 to 245 °C
Descending rate	: 6 °C / sec. Max.
Total soldering time	: 8 minutes Max., 25 to 245 °C
Times	: 2time

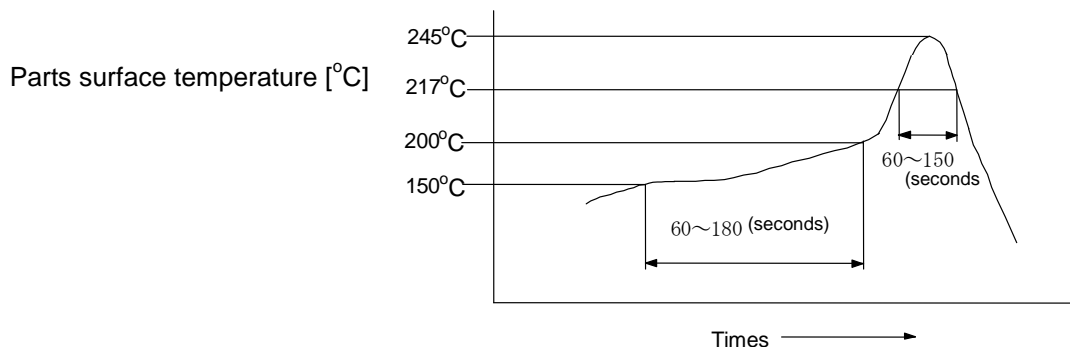

※Do not vibrate for the products on reflow.

Please need to take care temperature control because mounted parts may come off if the product are left under the high temperature.

Do not reflow DC-DC converter as follows, because DC-DC converter may fall down from a substrate during reflowing

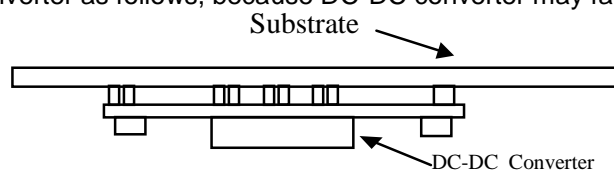

**Note:**

1. This datasheet is downloaded from the website of Murata Manufacturing co., Ltd. Therefore, it's specifications are subject to change or our products in it may be discontinued without advance notice. Please check with our sales representatives or product engineers before ordering.
2. This datasheet has only typical specifications because there is no space for detailed specifications. Therefore, please approve our product specifications or transact the approval sheet for product specifications before ordering.



## 14. Notice

## 14. 1. Input / output capacitor

When an inductance or a switch device is connected to the input line, or when you use a power supply with output inductance as the input voltage source, the input voltage of the DC-DC Converter will be fluctuated.

By this input voltage fluctuation, the transient load response of the DC-DC converter may be deteriorated or abnormal oscillation may occur. So please confirm normal operation on each application.

Please use external input capacitor in order to decrease inductance of input line.

In case you use external output capacitor in order to improve transient load response, please use input capacitor to prevent abnormal oscillation. When you use external capacitors, following capacitors are recommendable.

- ※Input capacitor C1 : Please use capacitors more than  $100\mu\text{F}$  of low impedance in high frequency range.  
Output capacitor C2 : Please use capacitors less than  $1000\mu\text{F}$

## 14. 2. Wiring of input / output capacitor

In the case of input / output capacitor connection, in order to reduce electrical noise, please design PCBs with consideration of the following item.

- ① Please be sure to check normal operation on your system.
- ② Please use low impedance capacitors with good high frequency characteristic.
- ③ Please shorten those leads of each capacitor as much as possible, and make sure the lead inductance low.
- ④ Both input-side and output side, please make the wiring loop between plus and minus as small as possible. The influence of leakage inductance can be reduced.
- ⑤ Please design the print pattern of the main circuit as wide and short as possible.

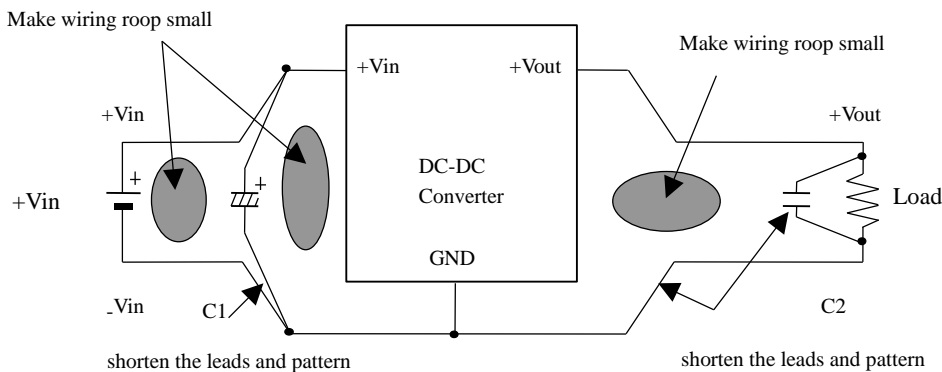

## 14. 3. This product could not be operated parallel or series.

## 14. 4. Please do not use a connector or a socket for connection with your board of this product.

Electrical performance may be deteriorated the influence of contact resistance.  
Please be sure to mount this product with solder.

## 14. 5. Be sure to provide an appropriate fail-safe function on your product to prevent a second damage that may be caused by the abnormal function or the failure of our product.

## 14. 6. Please connect the input terminal with proper polarity. If you connect wrong polarity, the DC-DC Converter may be broken. In the case of the DC-DC Converter is damaged, abnormal input current may flow in, and abnormal overheat of the DC-DC Converter, or some damage of your products may occur. Please use a diode and a fuse to as following figure.

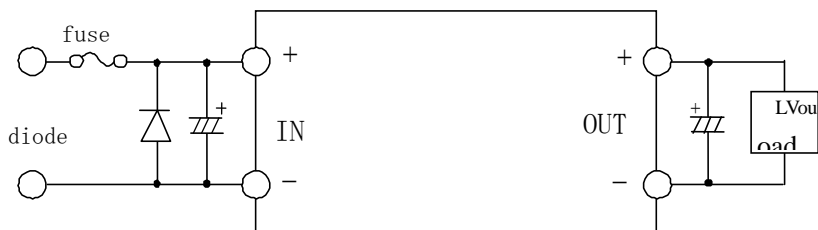

## ⚠ Note:

※Please select diode and fuse after confirming the operation.

1. This datasheet is downloaded from the website of Murata Manufacturing co., Ltd. Therefore, it's specifications are subject to change or our products in it may be discontinued without advance notice. Please check with our sales representatives or product engineers before ordering.
2. This datasheet has only typical specifications because there is no space for detailed specifications. Therefore, please approve our product specifications or transact the approval sheet for product specifications before ordering.

#### 14. 7 Cleaning

Please clean them to remove flux from them using the dipping, boiling, and vapor methods in isopropyl alcohol for up to 5 minutes.

Please inform us if you are to use aqueous or semi-aqueous cleaning or another methods.

Do not use ultrasonic cleaning because semiconductor device on the products, bonding wires may be broken by resonance.

After cleaning, please dry the products thoroughly. If you touch the products that have not been dried enough yet, you need to take care because the marking of the products may get thin or blurred.

Do not measure electrical characteristics, until the products get dried enough.

If you use no-cleaning type flux and you don't clean our products, you must confirm the reliability of the products fully in advance.

#### 14. 8 Storage

You should storage this product under MSL2 at the recommendable condition of soldering, which is described at 13.2. So this product can be stored without baking a half year at below 30°C 60%R.H.

In case you store them over the limit, please bake this product before soldering.

If these are unpacked condition, please bake them at 125°C ± 5°C/24hour. If these are packed in a tape, please bake them before soldering at 60°C ± 5°C/168hour.

Avoid damp heated places or such places where there are large temperature changes, because water may condense on the products, the characteristics may be reduced in quality, and/or be degraded in the solderability.

If you store the products for a long time (more than 1 year), the products may be degraded in solderability and may be rusty. Please confirm solderability for the products regularly.

14. 9 Please do not store the products in the places such as in a dusty place, in a place exposed directly to sea breeze, in an atmosphere containing corrosive gas (Cl<sub>2</sub>,NH<sub>3</sub>,SO<sub>2</sub>,NOX and so on).

#### 14. 10 Operational Environment and Operational Conditions

##### 14.10.1 Operational Environment

The products are not waterproof, chemical-proof or rust-proof.

In order to prevent leakage of electricity and abnormal temperature increase of the products, do not use the products under the following circumstances:

- (1) in an atmosphere containing corrosive gas (Cl<sub>2</sub>, NH<sub>3</sub>, SO<sub>2</sub>, NOX and so on).
- (2) in a dusty place.
- (3) in a place exposed to direct sunlight.
- (4) in such a place where water splashes or in such a humid place where water condenses.
- (5) in a place exposed to sea breeze.
- (6) in any other places similar to the above (1)through (5).

##### 14.10.2 Operational Conditions

Please use the products within specified values (power supply, temperature, input, output and load condition, and so on). Input voltage drop for line impedance, so please make sure that input voltage is included in specified values.

If you use the products over the specified values, it may break the products, reduce the quality, and even if the products can endure the condition for short time, it may cause degradation of the reliability.

Also please take care that the external voltage over output voltage of DC-DC Converter does not applies to output of this DC-DC Converter.

##### 14.10.3 Note prior to use

If you apply high static electricity, over rated voltage or reverse voltage to the products, it may cause defects in the products or degrade the reliability.

Please avoid the following items:

- (1) over rating power supply, reverse power supply or not-enough connection of 0 V(DC) line.
- (2) electrostatic discharge by production line and/or operator.
- (3) electrified product by electrostatic induction.

Do not give an excessive mechanical shock..

If you drop the products on the floor, etc., it may occur a crack to the core of inductors and monolithic ceramic capacitors.

Do not give a strong shock such as a drop in handling.

#### Note:

1. This datasheet is downloaded from the website of Murata Manufacturing co., Ltd. Therefore, it's specifications are subject to change or our products in it may be discontinued without advance notice. Please check with our sales representatives or product engineers before ordering.
2. This datasheet has only typical specifications because there is no space for detailed specifications. Therefore, please approve our product specifications or transact the approval sheet for product specifications before ordering.

## 14. 11 Transportation

If you transport the products, please pack them so that the package will not be damaged by mechanical vibration or mechanical shock, and please educate and guide a carrier to prevent rough handling. If you transport the products to overseas (in particular, by sea), it is expected that the transportation environment will be the worst, so please pack the products, in the package designed on the consideration of mechanical strength, vibration-resistant and humidity-resistant. The package of the products which Murata sells in Japan, may not resist over seas transport. Please consult us if you are to use the Murata package of the products sold in Japan for transport to overseas.

 Note

1. Murata recommends that customers ensure that the evaluation and testing of these devices are completed with this product actually assembled on their product.
2. Please contact our main sales office or nearby sales office before using our products for the applications listed below which require especially high reliability for the prevention of defects which might directly cause damage to the third party's life, body or property or this products for any other applications that described in the above.
  - ① Aircraft equipment
  - ② Aerospace equipment
  - ③ Undersea equipment
  - ④ Power plant control equipment
  - ⑤ Medical equipment
  - ⑥ Transportation equipment (vehicles, trains, ships, etc.)
  - ⑦ Traffic signal equipment
  - ⑧ Disaster prevention /crime prevention equipment
  - ⑨ Data-processing equipment
  - ⑩ Application of similar complexity and/or reliability requirements to the applications listed in the above.

This DATA Sheet is indicated in Apr. 2006. About the written contents, since changing without a preliminary announcement for improvement and supply are sometimes stopped, please confirm in case of ordering. If written contents are unknown, please ask to our main sales office or nearby sales office.

 Note:

1. This datasheet is downloaded from the website of Murata Manufacturing co., Ltd. Therefore, it's specifications are subject to change or our products in it may be discontinued without advance notice. Please check with our sales representatives or product engineers before ordering.
2. This datasheet has only typical specifications because there is no space for detailed specifications. Therefore, please approve our product specifications or transact the approval sheet for product specifications before ordering.