

**ML9272****40-Bit Vacuum Fluorescent Display Tube Grid/Anode Driver****GENERAL DESCRIPTION**

The ML9272 is a monolithic IC designed for directly driving the grids and anodes of the vacuum fluorescent display tube. The device contains a 40-bit bidirectional shift register, a 40-bit latch circuit, and 40-output circuit on a single chip.

Display data is serially stored in the shift register at the rising edge of a CLOCK pulse.

Setting the  $\overline{CL}$  pin low allows all the driver outputs to be driven low, which makes it possible to set the display blanking.

Also, setting both of the  $\overline{CL}$  and CHG pins high allows all the driver outputs to be driven high, which provides the easy testing of all lights after final assembly of a VFD tube panel.

The ML9272 is compatible with the MSC1162A.

**FEATURES**

- Logic Supply Voltage ( $V_{DD}$ ) : 3.3V±10%or5V±10%
- Driver Supply Voltage ( $V_{DISP}$ ) : 65V
- Driver Output Current :  $I_{OHVH1}$  (Only one driver output: "H") : -40mA  
:  $I_{OHVH2}$  (All the driver outputs:"H") : -2mA  
:  $I_{OHVL}$  : 1mA
- Directly connected to VFD tube without pull-down resistors
- Data transfer speed : 5MHz
- Package:  
60-pin plastic SSOP (SSOP60-P-700-0.65-BK)(Product name: ML9272MB)

**BLOCK DIAGRAM**

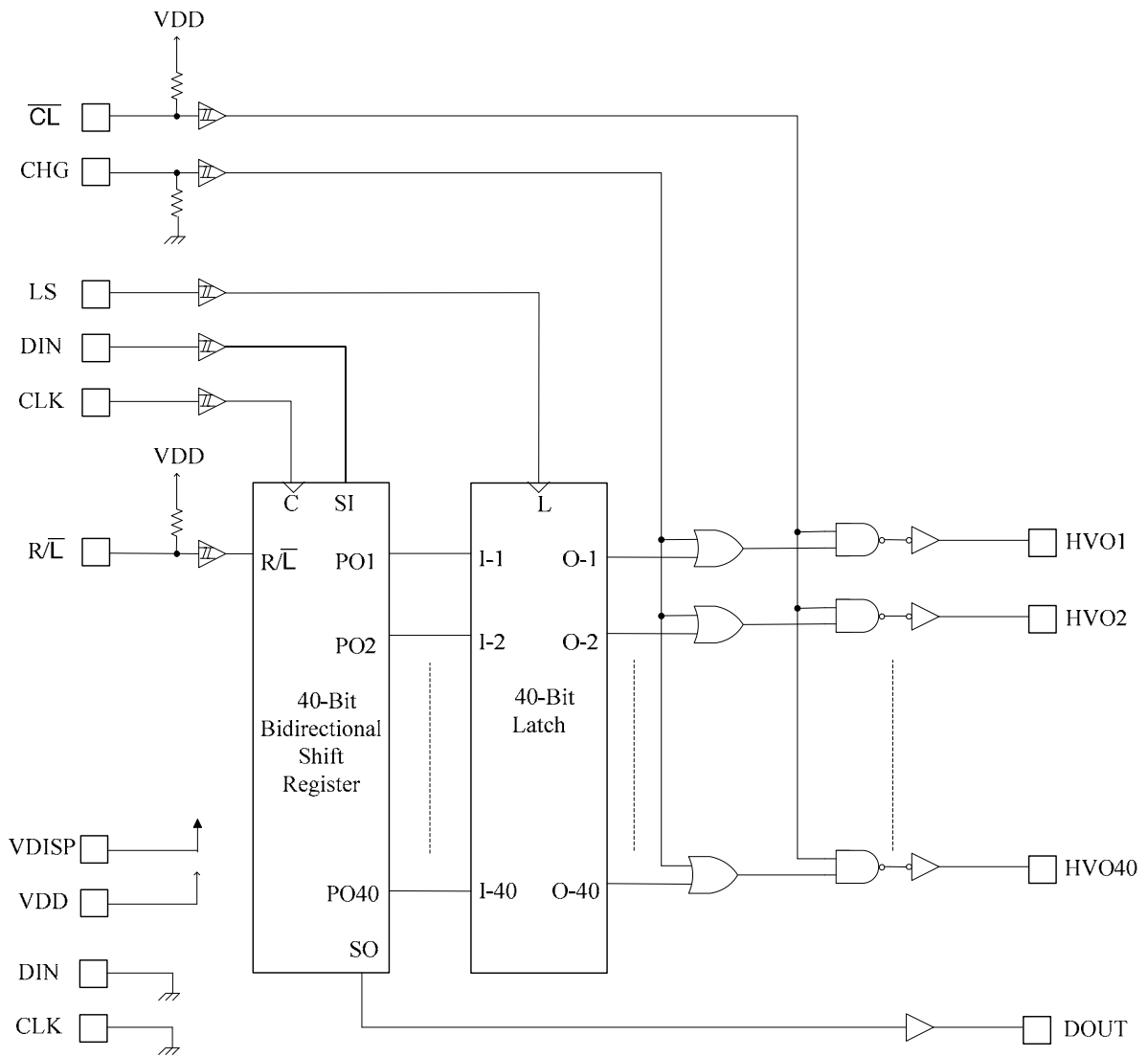

**PIN CONFIGURATION (TOP VIEW)**

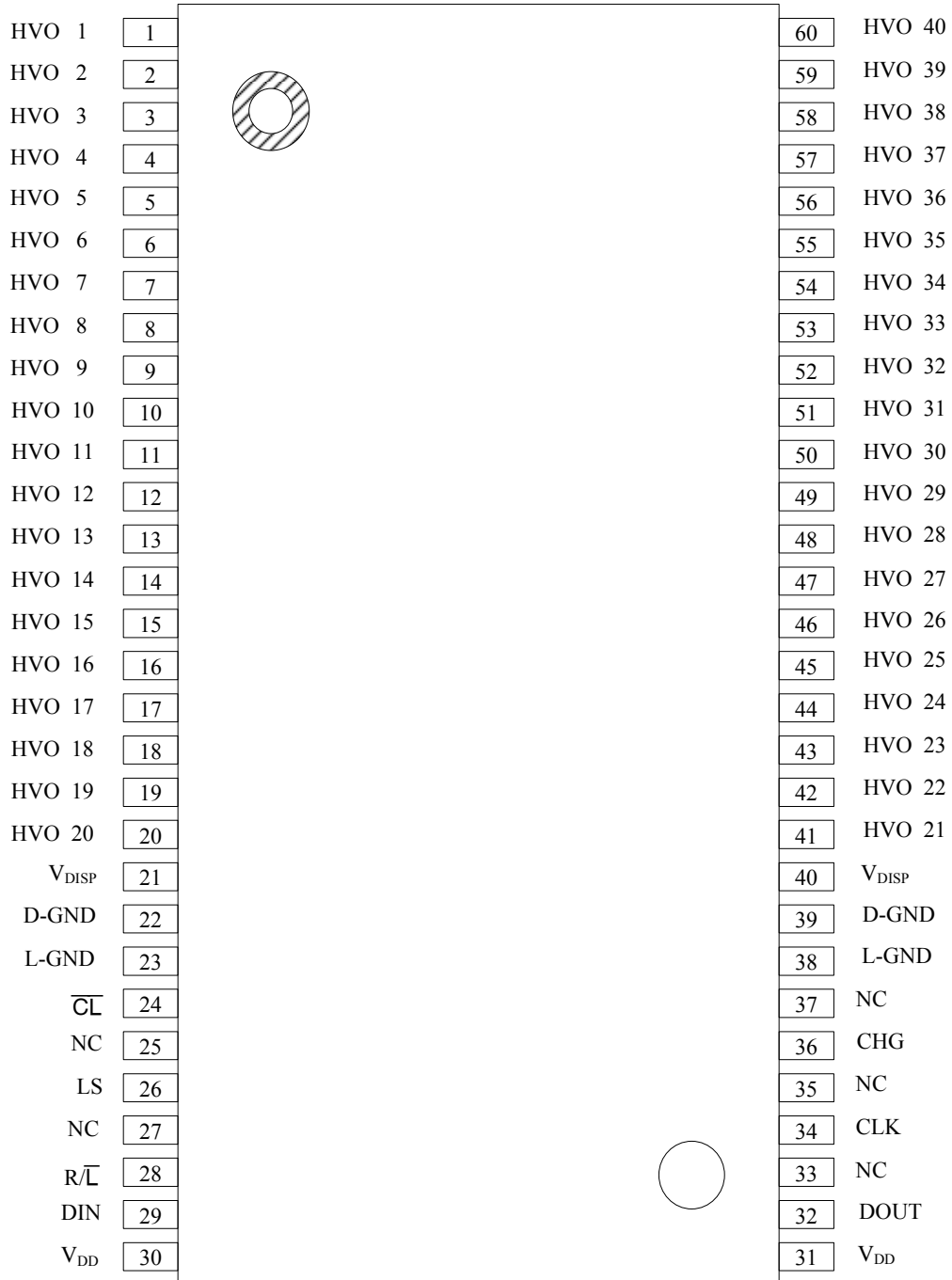

NC: No-connection pin

**60-Pin Plastic SSOP**

## PIN DESCRIPTION

Symbol	Type	Description
CLK	I	Shift register clock input pin. Shift register reads data through DIN while the CLK pin is in a low state and the data in the shift register is shifted from one stage to the next stage at the rising edge of the clock.
DIN	I	Serial data input pin of the shift register. Display data (positive logic) is input through the DIN pin in synchronization with clock.
DOUT	O	Serial data output pin of the shift register. Data is output through the DOUT pin in synchronization with the CLK signal. When $R/\bar{L}$ = High, the data of PO40 in the shift register is output through the DOUT pin. When $R/\bar{L}$ = Low, the data of PO1 in the shift register is output through the DOUT pin.
LS	I	Latch strobe input pin When LS is high, the parallel output data (PO1-40) of the shift register read out. When LS goes from high to low, the parallel output data (PO1-40) of the shift register is held.
$\bar{CL}$	I	Clear input pin with a built-in pull-up resistor The $\bar{CL}$ pin is normally being set high. If the $\bar{CL}$ pin is high and the CHG pin is low, the driver outputs (HV01 to HV40) are in phase with the corresponding latch outputs (O1 to O40). If the $\bar{CL}$ pin is high and the CHG pin is high, the driver outputs (HV01 to HV40) are high irrespective of the states of the latch outputs. If the $\bar{CL}$ pin is set low, the driver outputs are driven low irrespective of the states of the CHG pin and latch outputs. This allows display blanking to be set.
CHG	I	Input for testing (with a pull-down resistor) The CHG pin is normally being set low. If the CHG pin is low and the $\bar{CL}$ pin is high, the driver outputs (HV01 to HV40) are in phase with the corresponding latch outputs (O1 to O40). If the CHG pin is low and the $\bar{CL}$ pin is low, the driver outputs (HV01 to HV40) are low irrespective of the states of the latch outputs. If the CHG pin is set high and the $\bar{CL}$ pin is high, the driver outputs are driven high irrespective of the states of the latch outputs. This provides the easy testing of all lights after final assembly.
HVO1-40	O	High voltage driver outputs for driving a VFD tube The driver outputs are in phase with the corresponding latch outputs (O1 to O40). The direct connection to the grid or anode of a VFD tube eliminates pull-down resistors.
$V_{DISP}$	—	Power supply pin for driver circuits of VFD tube
$V_{DD}$	—	Power supply pin for logic
D-GND	—	GND pin for driver circuits of a VFD tube. (D-GND) Since the D-GND is not connected to L-GND, connect this pin to the external L-GND.
L-GND	—	GND pin for logic circuits. (L-GND) Since the L-GND pin is not connected to D-GND, connect this pin to the external D-GND.
$R/\bar{L}$	I	Data shift direction control pin with a built-in pull-up resistor. When $R/\bar{L}$ = High, the data shifts from shift register PO1 to shift register PO40. When $R/\bar{L}$ = Low, the data shifts from shift register PO40 to shift register PO1.

**ABSOLUTE MAXIMUM RATINGS**

Parameter	Symbol	Condition	Rating	Unit
Logic Supply Voltage *1	V <sub>DD</sub>	Applicable to the logic supply pin	-0.3 to +6.5	V
Driver Supply Voltage *1, *2	V <sub>DISP</sub>	Applicable to the driver supply pin	-0.3 to +7.0	V
Input Voltage	V <sub>IN</sub>	Applicable to all input pins	-0.3 to V <sub>DD</sub> +0.3	V
Data Output Voltage	V <sub>O1</sub>	Applicable to the data output pin	-0.3 to V <sub>DD</sub> +0.3	V
Driver Output Voltage	V <sub>O2</sub>	Applicable to the driver output pin	-0.3 to V <sub>DISP</sub> +0.3	V
Power Dissipation	P <sub>D</sub>	T <sub>a</sub> ≤ 105°C	266	mW
Package Thermal Resistance *3	R <sub>j-a</sub>	—	75	°C/W
Storage Temperature	T <sub>STG</sub>	—	-55 to +150	°C
Output Current	I <sub>O1</sub>	HVO1 to HVO40	-50.0 to 2.0	mA
	I <sub>O2</sub>	DOUT	-2.0 to 2.0	

Notes: \*1 Maximum Supply Voltage with respect to L-GND and D-GND

\*2 Permanent damage may be caused if the voltage is supplied over the rating value.

\*3 Package Thermal Resistance (between junction and ambient)

The junction temperature (T<sub>j</sub>) expressed by the equation indicated below should not exceed 150°C.

$T_j = P \times R_{j-a} + T_a$  (P: Maximum power dissipation)

**RECOMMENDED OPERATING CONDITIONS**

Parameter	Symbol	Condition	Min.	Typ.	Max.	Unit
Supply Voltage (1)	$V_{DD}$	When the power supply voltage is 5.0 V (typ.)	4.5	5.0	5.5	V
		When the power supply voltage is 3.3 V (typ.)	3.0	3.3	3.6	V
Supply Voltage (2)	$V_{DISP}$	Applicable to the driver supply voltage pin	10	—	65	V
CLOCK Frequency	$f_{CLK}$	See the timing diagram	—	—	5	MHz
Operating Temperature	$T_a$	—	−40	—	105	°C

## ELECTRICAL CHARACTERISTICS

### DC Characteristics

( $V_{DD} = 3.0$  to  $3.6V$  or  $4.5$  to  $5.5V$ ,  $V_{DISP} = 10$  to  $65V$ ,  $T_a = -40$  to  $+105^{\circ}C$ )

Parameter	Symbol	Condition		Min.	Typ.	Max.	Unit	
High Level Input Voltage	$V_{IH}$	All inputs	$V_{DD} = 5.0 V \pm 10 \%$	$0.8 V_{DD}$	—	—	V	
			$V_{DD} = 3.3 V \pm 10 \%$	$0.8 V_{DD}$	—	—	V	
Low Level Input Voltage	$V_{IL}$	All inputs	$V_{DD} = 5.0 V \pm 10 \%$	—	—	$0.2V_{DD}$	V	
			$V_{DD} = 3.3 V \pm 10 \%$	—	—	$0.2V_{DD}$	V	
High Level Input Current	$I_{IH1}$	$V_I = V_{DD}$	CHG pin	$V_{DD} = 5.0V$	5	—	120	$\mu A$
				$V_{DD} = 3.3V$	2.5	—	40	$\mu A$
	$I_{IH2}$	Other input pins	—1	—	1	$\mu A$		
Low Level Input Current	$I_{IL1}$	$V_I = 0V$	$\overline{CL}$ , $\overline{R/L}$ pin	$V_{DD} = 5.0V$	—80	—	—5	$\mu A$
				$V_{DD} = 3.3V$	—40	—	—2.5	$\mu A$
	$I_{IL2}$	Other input pins	—1	—	1	$\mu A$		
Driver High Level Output Voltage	$V_{OH1-1}$	HVO1 to HVO40	$I_{OH1-1} = -40mA$ , $V_{DISP} = 65V$ Only one output is high	$V_{DISP}-5.0$	—	—	V	
	$V_{OH1-2}$	HVO1 to HVO40	$I_{OH1-2} = -2.0mA$ , $V_{DISP} = 65V$ All outputs are high	$V_{DISP}-0.7$	—	—	V	
	$V_{OH2}$	DOUT	$I_{OH2} = -0.1mA$	$V_{DD}-1.0$	—	—	V	
Driver Low Level Output Voltage	$V_{OL1}$	HVO1 to HVO40	$I_{OL1} = 1.0mA$	—	—	3.0	V	
	$V_{OL2}$	DOUT	$I_{OL2} = 0.1mA$	—	—	1.0	V	
Supply Current (1) (Dynamic Mode)	$I_{DD}$	$V_{DD}$	$V_{DD} = 5.0 \pm 10\%$ Input Data = "1" "0" "1" ..	—	—	2.5	mA	
			$V_{DD} = 3.3 \pm 10\%$ Input Data = "1" "0" "1" ..	—	—	2.0	mA	
	$I_{DISP}$	$V_{DISP}$	Input Data = "1" "0" "1" ..	—	—	0.5	mA	
Supply Current (2) (Static Mode)	$I_{DDS1}$	$V_{DD}$	No Operation $T_a = 25^{\circ}C$	—	—	1.0	$\mu A$	
	$I_{DDS2}$		No Operation $T_a = 85^{\circ}C$	—	—	10.0	$\mu A$	
	$I_{DISPS1}$	$V_{DISP}$	No Operation $T_a = 25^{\circ}C$	—	—	1.0	$\mu A$	
	$I_{DISPS2}$		No Operation $T_a = 85^{\circ}C$	—	—	20.0	$\mu A$	

## AC Characteristics

(V<sub>DD</sub> = 3.0 to 3.6V or 4.5 to 5.5V, V<sub>DISP</sub> = 10 to 65V, T<sub>a</sub> = -40 to +105°C)

Parameter	Symbol	Condition	Min.	Typ.	Max.	Unit
CLOCK Pulse Width	t <sub>W(CLK)</sub>	—	75	—	—	ns
DATA Setup Time	t <sub>SU(D-CLK)</sub>	—	80	—	—	ns
DATA Hold Time	t <sub>H(CLK-D)</sub>	—	50	—	—	ns
Latch Probe Pulse Width	t <sub>W(LS)</sub>	—	80	—	—	ns
CHG Pulse Width	t <sub>W(CHG)</sub>	—	6	—	—	μs
$\overline{\text{CL}}$ Pulse Width	t <sub>W(<math>\overline{\text{CL}}</math>)</sub>	—	6	—	—	μs
CLK-LS Delay Time	t <sub>SU(CLK-LS)</sub>	—	50	—	—	ns
LS-CLK Delay Time	t <sub>SU(LS-CLK)</sub>	—	0	—	—	ns
LS-CHG Delay Time	t <sub>SU(LS-CHG)</sub>	—	0	—	—	μs
LS- $\overline{\text{CL}}$ Delay Time	t <sub>SU(LS-<math>\overline{\text{CL}}</math>)</sub>	—	0	—	—	μs
DATA OUT Delay Time	t <sub>PD</sub>	C <sub>11</sub> = 30 pF	—	—	300	ns
All Output Delay Time	t <sub>DLH</sub>	C <sub>1d</sub> = 100 pF t <sub>R</sub> = 20 to 80% t <sub>F</sub> = 80 to 20%	—	0.3	1.0	μs
	t <sub>DHL</sub>		—	2.0	5.0	μs
All Output Slew Rate	t <sub>TLH</sub>	C <sub>1d</sub> = 100 pF t <sub>R</sub> = 20 to 80% t <sub>F</sub> = 80 to 20%	—	0.3	1.0	μs
	t <sub>THL</sub>		—	2.0	5.0	μs



**TIMING DIAGRAM**



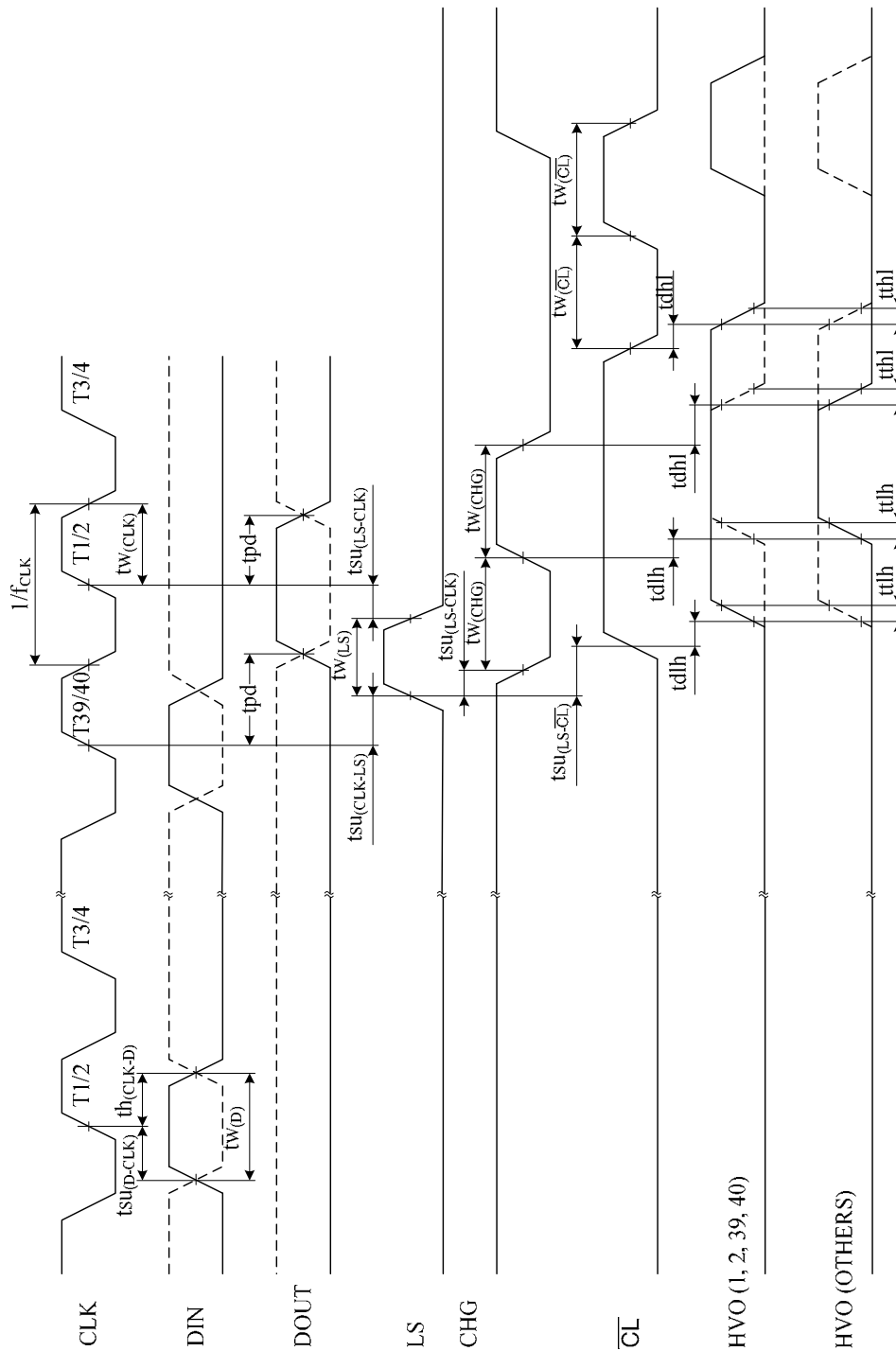

Symbol	$V_{DD} = 3.3\text{ V} \pm 10\%$	$V_{DD} = 5.0\text{ V} \pm 10\%$
$V_{IH} / V_{IL}$	$0.8 V_{DD} / 0.2 V_{DD}$	$0.7 V_{DD} / 0.3 V_{DD}$
$V_{OH} / V_{OL}$	$0.8 V_{DISP} / 0.2 V_{DISP}$	$0.8 V_{DISP} / 0.2 V_{DISP}$
	$0.8 V_{DD} / 0.2 V_{DD}$	$0.8 V_{DD} / 0.2 V_{DD}$



## FUNCTIONAL DESCRIPTION

### Function Table

Shift register

Input			Shift Register Parallel Out					Output
CLK	R/L	DIN	PO1	PO2		PO39	PO40	DOUT
	X	X	Not changed					Not changed
	H	L	L	PO1n		PO38n	PO39n	PO40
	H	H	H	PO1n		PO38n	PO39n	PO40
	L	L	PO2n	PO3n		PO40n	L	PO1
	L	H	PO2n	PO3n		PO40n	H	PO1

X: Don't Care

PO1n to PO40n: PO1 to PO40 data just before CLOCK rises.

Latch

Input	Shift Register Parallel Out	Latch Output
LS	P <sub>Om</sub>	O <sub>m</sub>
L	X	Not changed
H	L	L
H	H	H

X: Don't Care, m: 1 to 40

Driver output

Input		Latch Output	Driver Output
$\overline{CL}$	CHG	O <sub>m</sub>	HV <sub>Om</sub>
L	X	X	L
H	H	X	H
H	L	L	L
H	L	H	H

X: Don't Care, m: 1 to 40

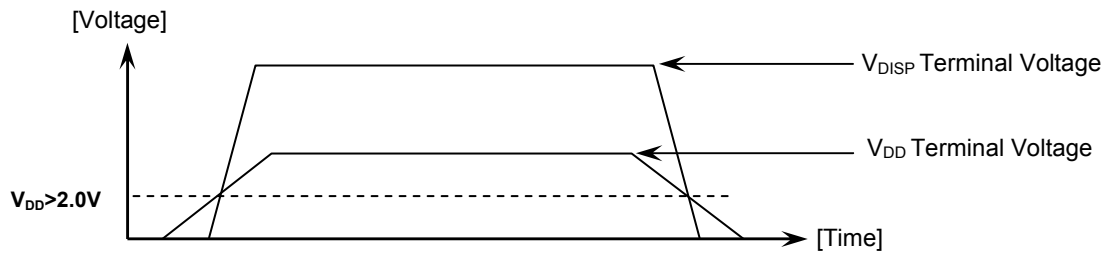
**POWER-ON/OFF TIMING**

To prevent IC from malfunctioning, V<sub>DISP</sub> should be applied after V<sub>DD</sub> is applied.  
When turning off the power, V<sub>DD</sub> should be applied after V<sub>DISP</sub> is applied.

**NOTES ON USE**

1. Connect D-GND to L-GND externally to be an equal potential voltage.
2. The contents of the shift register are undefined when the power is applied.

Therefore, unnecessary driver outputs may be driven high just after power-on, and the VFD tube may flicker.

To avoid this, follow the procedures:

- 1) Apply the driver power supply after applying the logic power supply, with the  $\overline{\text{CL}}$  pin remained low.
- 2) Start displaying by setting the  $\overline{\text{CL}}$  pin high after putting display data from the shift register through the DIN pin.

**PACKAGE DIMENSIONS**

(Unit: mm)

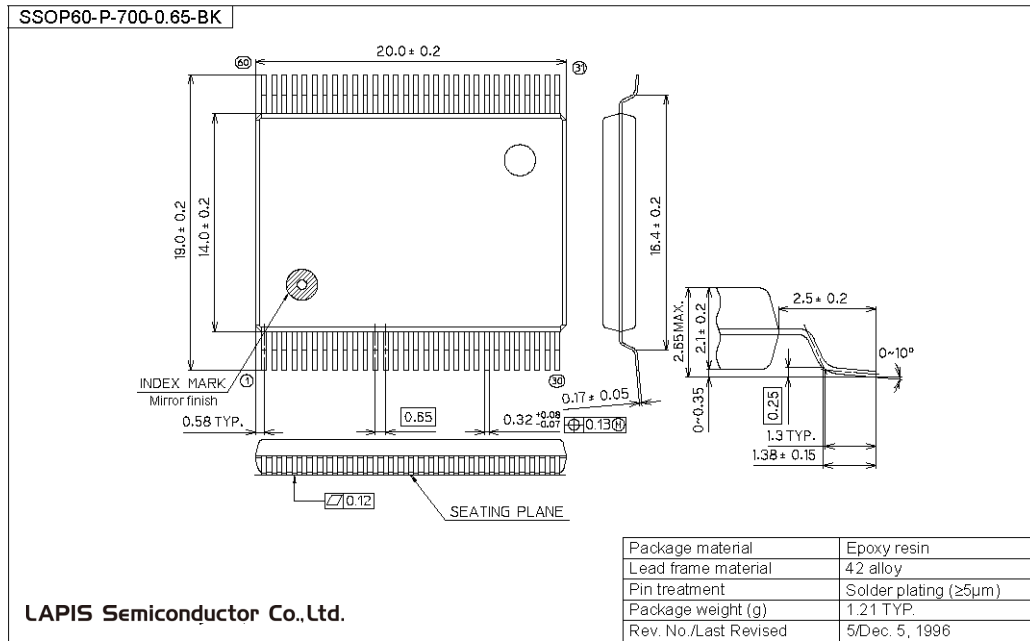

**Notes for Mounting the Surface Mount Type Package**

The surface mount type packages are very susceptible to heat in reflow mounting and humidity absorbed in storage. Therefore, before you perform reflow mounting, contact ROHM's responsible sales person for the product name, package name, pin number, package code and desired mounting conditions (reflow method, temperature and times).

**REVISION HISTORY**

Document No.	Date	Page		Description
		Previous Edition	Current Edition	
PEDL9272-01	Dec. 21, 2005	–	–	Preliminary edition 1
PEDL9272-02	Mar. 17, 2006	1	1	$I_{OHVH2}$ (All the driver outputs:“H”) : -7mA → -2mA
		7	7	$I_{IH1}$ MAX 80 $\mu$ A → 120 $\mu$ A $V_{OH1-1}$ MIN $V_{DISP}$ -4.0V → $V_{DISP}$ -5.0V $V_{OH1-2}$ Condition $I_{OH1-2} = -7.0mA$ → -2.0mA
		8	8	CHG Pulse Width , $\overline{CL}$ Pulse Width Min 2 $\mu$ s → 6 $\mu$ s
FEDL9272-02	April. 27, 2006	–	–	Final edition 1

NOTICE

No copying or reproduction of this document, in part or in whole, is permitted without the consent of LAPIS Semiconductor Co., Ltd.

The content specified herein is subject to change for improvement without notice.

The content specified herein is for the purpose of introducing LAPIS Semiconductor's products (hereinafter "Products"). If you wish to use any such Product, please be sure to refer to the specifications, which can be obtained from LAPIS Semiconductor upon request.

Examples of application circuits, circuit constants and any other information contained herein illustrate the standard usage and operations of the Products. The peripheral conditions must be taken into account when designing circuits for mass production.

Great care was taken in ensuring the accuracy of the information specified in this document. However, should you incur any damage arising from any inaccuracy or misprint of such information, LAPIS Semiconductor shall bear no responsibility for such damage.

The technical information specified herein is intended only to show the typical functions of and examples of application circuits for the Products. LAPIS Semiconductor does not grant you, explicitly or implicitly, any license to use or exercise intellectual property or other rights held by LAPIS Semiconductor and other parties. LAPIS Semiconductor shall bear no responsibility whatsoever for any dispute arising from the use of such technical information.

The Products specified in this document are intended to be used with general-use electronic equipment or devices (such as audio visual equipment, office-automation equipment, communication devices, electronic appliances and amusement devices).

The Products specified in this document are not designed to be radiation tolerant.

While LAPIS Semiconductor always makes efforts to enhance the quality and reliability of its Products, a Product may fail or malfunction for a variety of reasons.

Please be sure to implement in your equipment using the Products safety measures to guard against the possibility of physical injury, fire or any other damage caused in the event of the failure of any Product, such as derating, redundancy, fire control and fail-safe designs. LAPIS Semiconductor shall bear no responsibility whatsoever for your use of any Product outside of the prescribed scope or not in accordance with the instruction manual.

The Products are not designed or manufactured to be used with any equipment, device or system which requires an extremely high level of reliability the failure or malfunction of which may result in a direct threat to human life or create a risk of human injury (such as a medical instrument, transportation equipment, aerospace machinery, nuclear-reactor controller, fuel-controller or other safety device). LAPIS Semiconductor shall bear no responsibility in any way for use of any of the Products for the above special purposes. If a Product is intended to be used for any such special purpose, please contact a ROHM sales representative before purchasing.

If you intend to export or ship overseas any Product or technology specified herein that may be controlled under the Foreign Exchange and the Foreign Trade Law, you will be required to obtain a license or permit under the Law.

Copyright 2006 - 2011 LAPIS Semiconductor Co., Ltd.