

DETAILS

Product Number	C13604_STRADA-2X2-FN
Family	Strada
Type	Lens array
Color	clear
Diameter	50 + 50 mm
Height	10 mm
Style	square
Optic Material	PMMA
Holder Material	
Fastening	glue, pin, screw
Status	production ready
ROHS Compliant	Yes
Date Updated	23/11/2016



OPTICAL PROPERTIES

LED	Viewing Angle	Light Beam	Efficiency	cd/lm	Connector
XM-L	Asymmetric deg	Asymmetric	94 %	1.200	-
XT-E	sim: Asymmetric	Asymmetric	91 %	1.400	-
XM-L2	asymmetric deg	Asymmetric	94 %	1.200	-
XP-L	Asymmetric deg	Asymmetric	94 %	0.960	-
XP-L HI	asymmetric deg	Asymmetric	94 %	1.100	-
XP-G3	Asymmetric deg	Asymmetric	94 %	1.000	-
XP-L2	Asymmetric deg	Asymmetric	94 %	0.980	-
H35C1 (LEMWA33)	Asymmetric deg	Asymmetric	94 %	1.100	-
LUXEON Q	asymmetric deg	Asymmetric	94 %	1.000	-
LUXEON T	asymmetric deg	Asymmetric	94 %	1.060	-
LUXEON TX	asymmetric deg	Asymmetric	94 %	1.100	-
LUXEON MZ	Asymmetric deg	Asymmetric	94 %	1.200	-
NVSxx19B/NVSxx19C	Asymmetric deg	Asymmetric	94 %	1.100	-
NVSxE21A	asym deg	Asymmetric	94 %	1.500	-
NVSW3x9A	Asymmetric deg	Asymmetric	94 %	1.100	-
NWSx229A	sim: Asym	Asymmetric	sim: 93 %	sim: 1.200	-
Oslon Square PC	Asymmetric deg	Asymmetric	94 %	1.200	-
Oslon Square Gen3	sim: Asymmetric	Asymmetric	94 %	1.100	-
Duris S8	Asymmetric deg	Asymmetric	sim: 92 %	sim: 1.300	-
Duris P8	sim: Asym	Asymmetric	sim: 94 %	sim: 1.600	-
Fortimo FastFlex LED board 2x8 DA G4	Asymmetric deg	Asymmetric	94 %	1.200	-
LH351B	Asymmetric deg	Asymmetric	94 %	1.080	-
LH351B	Asymmetric deg	Asymmetric	91 %	1.030	Undefined Manufacturer: Protective Plate, Glass
LH351D	sim: asym	Asymmetric	sim: 92 %	sim: 1.400	-
Z5M1/Z5M2	asymmetric deg	Asymmetric	94 %	1.200	-



PRODUCT DATASHEET

Strada series

last update 23/11/2016

OPTICAL PROPERTIES

LED	Viewing Angle	Light Beam	Efficiency	cd/lm	Connector
TL1L3	Asymmetric deg	Asymmetric	94 %	0.940	-
TL1L4	Asymmetric deg	Asymmetric	91 %	1.200	-
RLE G1 49x223mm 4000lm xxx EXC OT	Asymmetric deg	Asymmetric	94 %	1.300	-
RLE G1 49x245mm 4000lm xxx EXC OT	Asymmetric deg	Asymmetric	94 %	1.300	-
RLE G1 49x121mm 2000lm xxx EXC OT	Asymmetric deg	Asymmetric	94 %	1.300	-
RLE G1 49x133mm 2000lm xxx EXC OT	Asymmetric deg	Asymmetric	94 %	1.300	-

H G F E D C B A

4

3

2

1

4

3

2

1

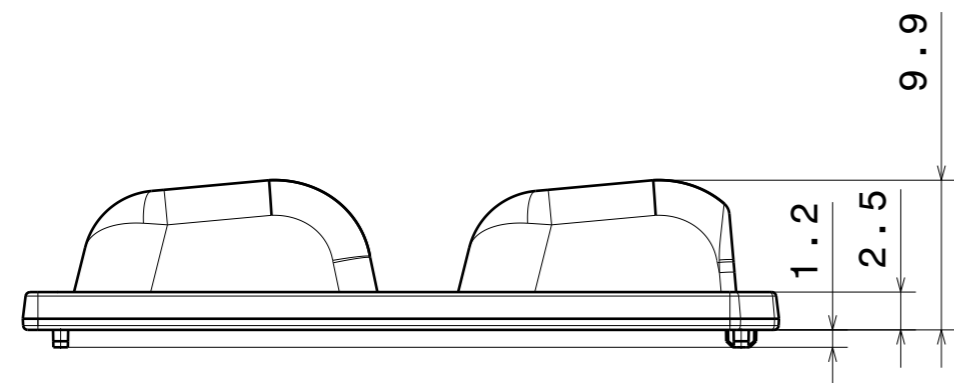

Front view

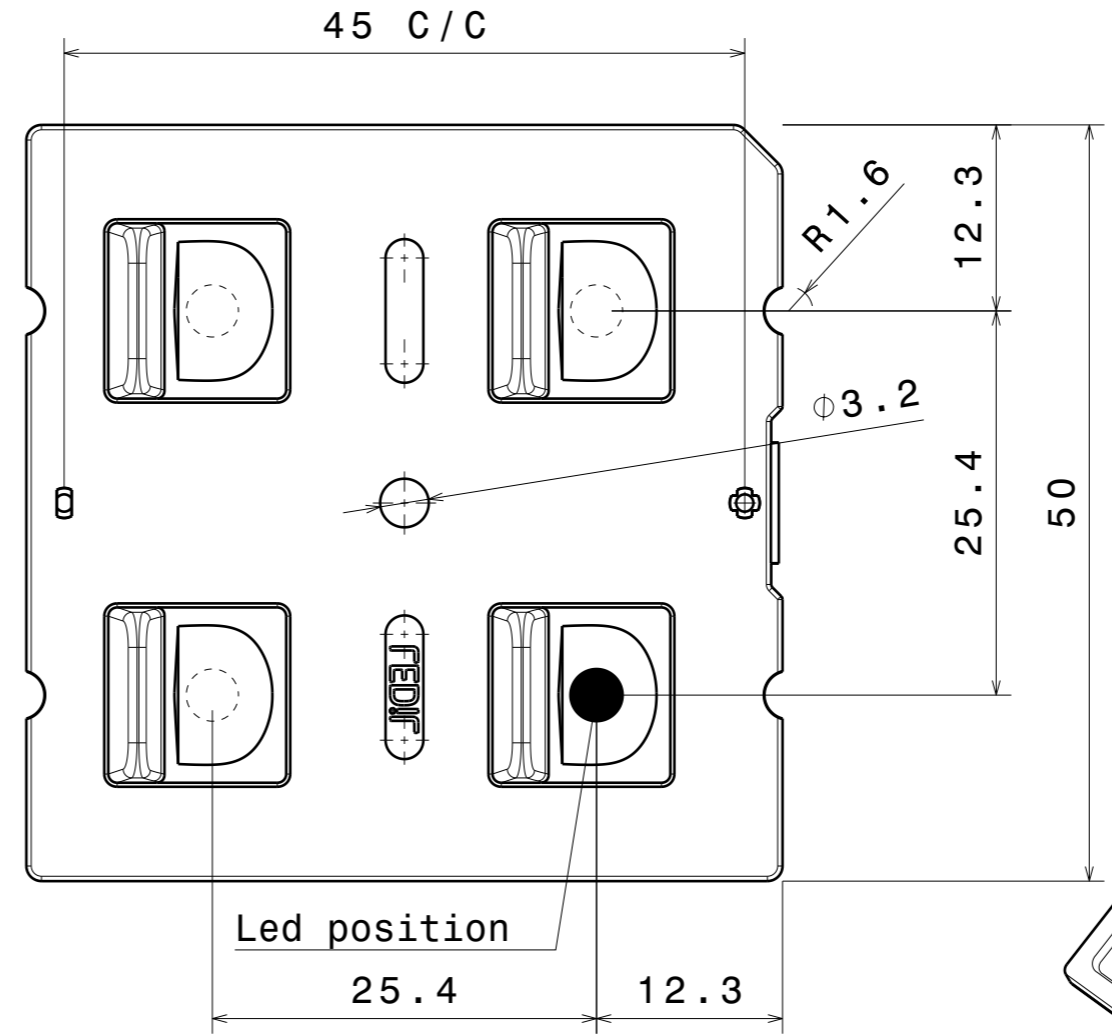

Bottom view

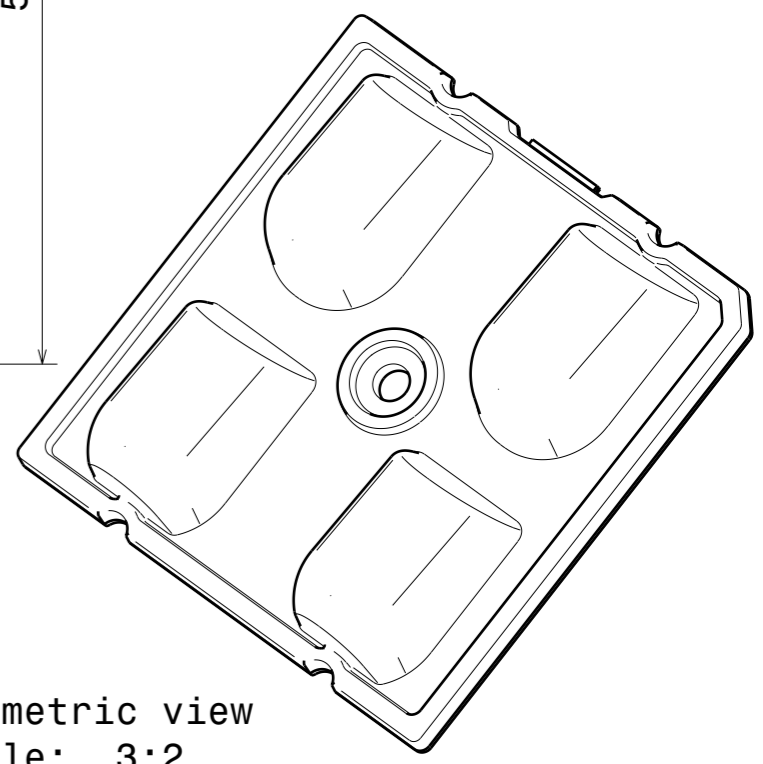

Isometric view
Scale: 3:2

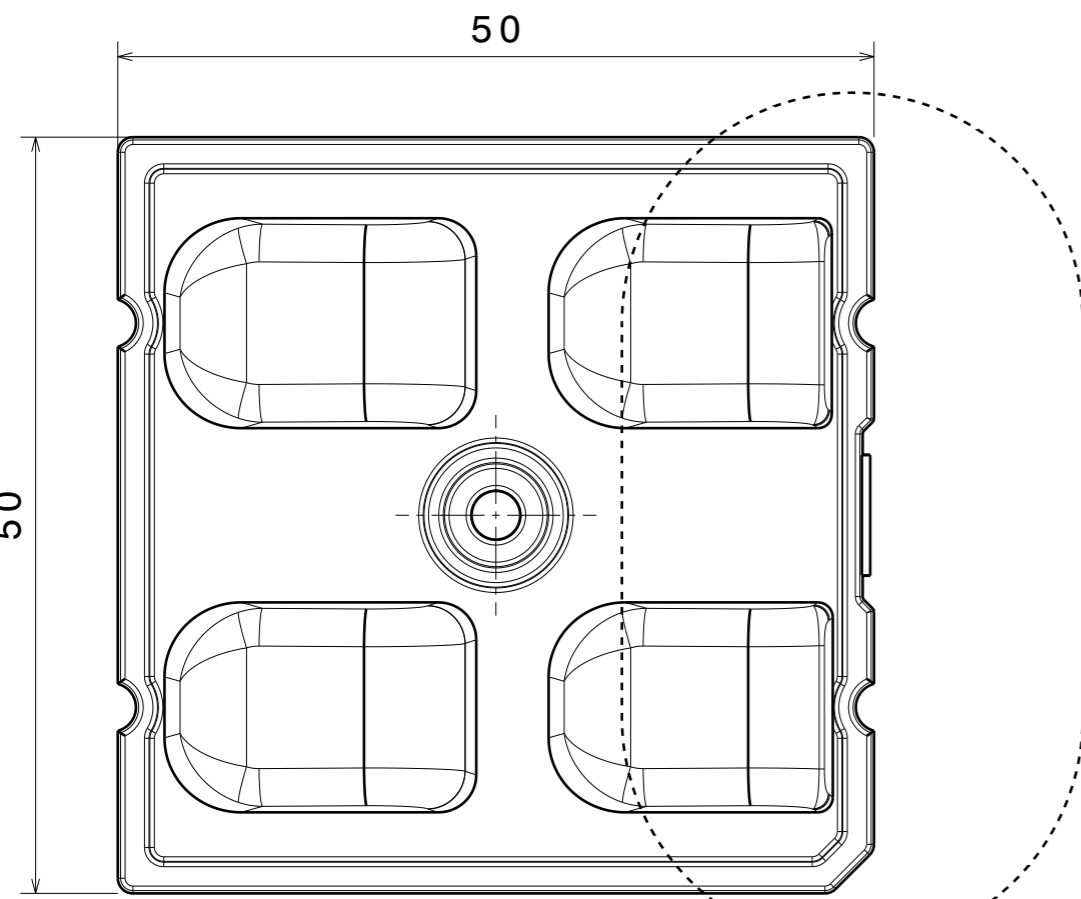

Top view

Beam direction

INDEX	PART NO	DESCRIPTION	MATERIAL	COLOUR
1	C13604	STRADA-2X2-FN	PMMA	

Tolerances if not otherwise shown
According to DIN ISO 2768-1
Linear measures:
Up to 30mm class M, otherwise class C.
According to DIN ISO 2768-2
Form and position: class L

LEDiL LediL Oy
Salorankatu 10
FIN 24240 SALO
Finland

THIRD ANGLE PROJECTION:

DRAWING TITLE
C13604_STRADA-2X2-FN

This drawing is the property of LEDiL Oy. It may not be reproduced, copied or communicated without a written agreement with LEDiL Oy."

SIZE	PART NUMBER
A3	C13604

SCALE	2:1	WEIGHT	-	SHEET	1/1
-------	-----	--------	---	-------	-----

H G F E D C B A

Luminaire: LEDiL Oy C13604_STRADA-2X2-FN_(XM-L) Eff. 94%
Lamps: 1 x Cree XM-L 355.205lm@250mA P=2.83062W I=0.2499A

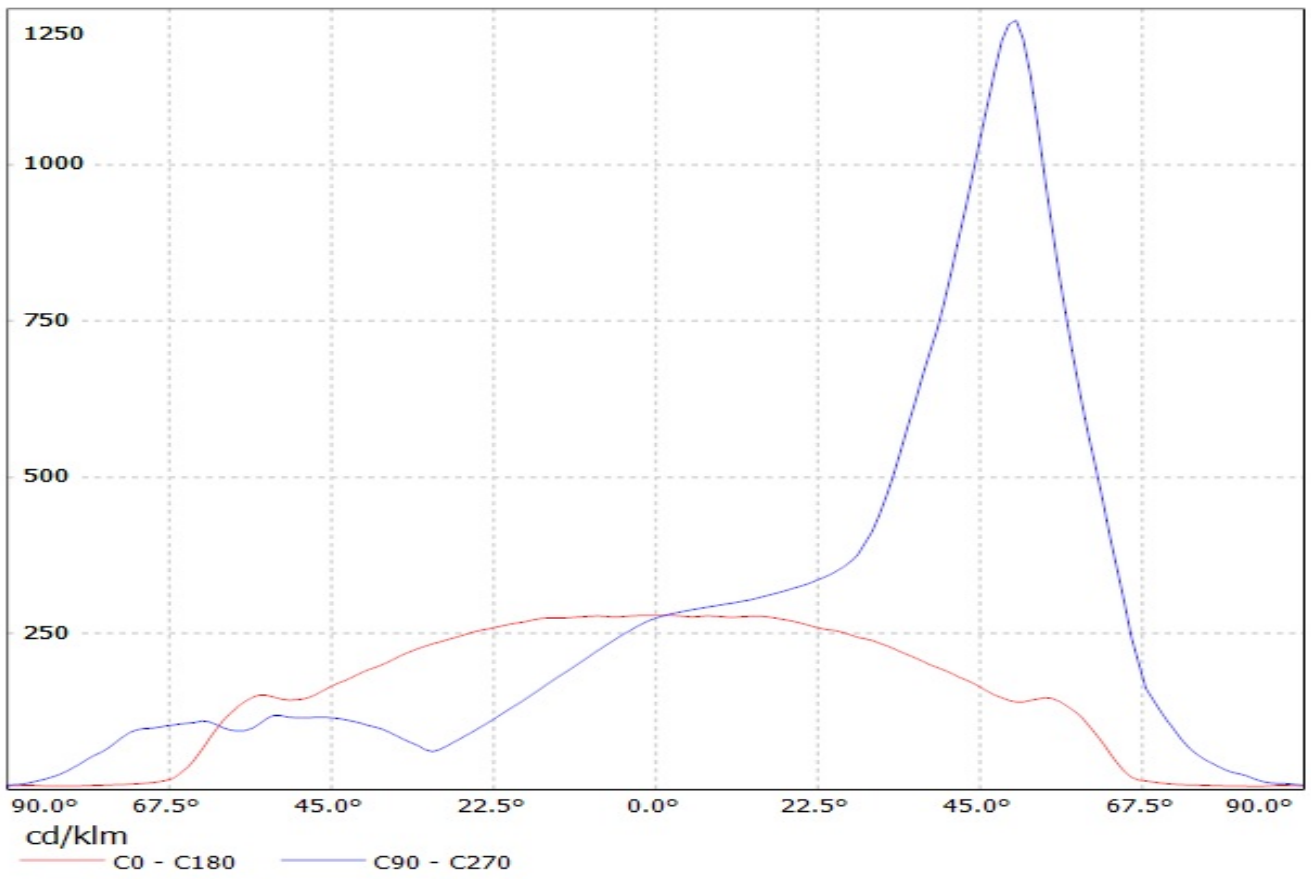

Luminaire: Ledil Oy C13604_STRADA-2X2-FN_(XT-E)_SIMULATED
Lamps: 1 x Cree XT-E

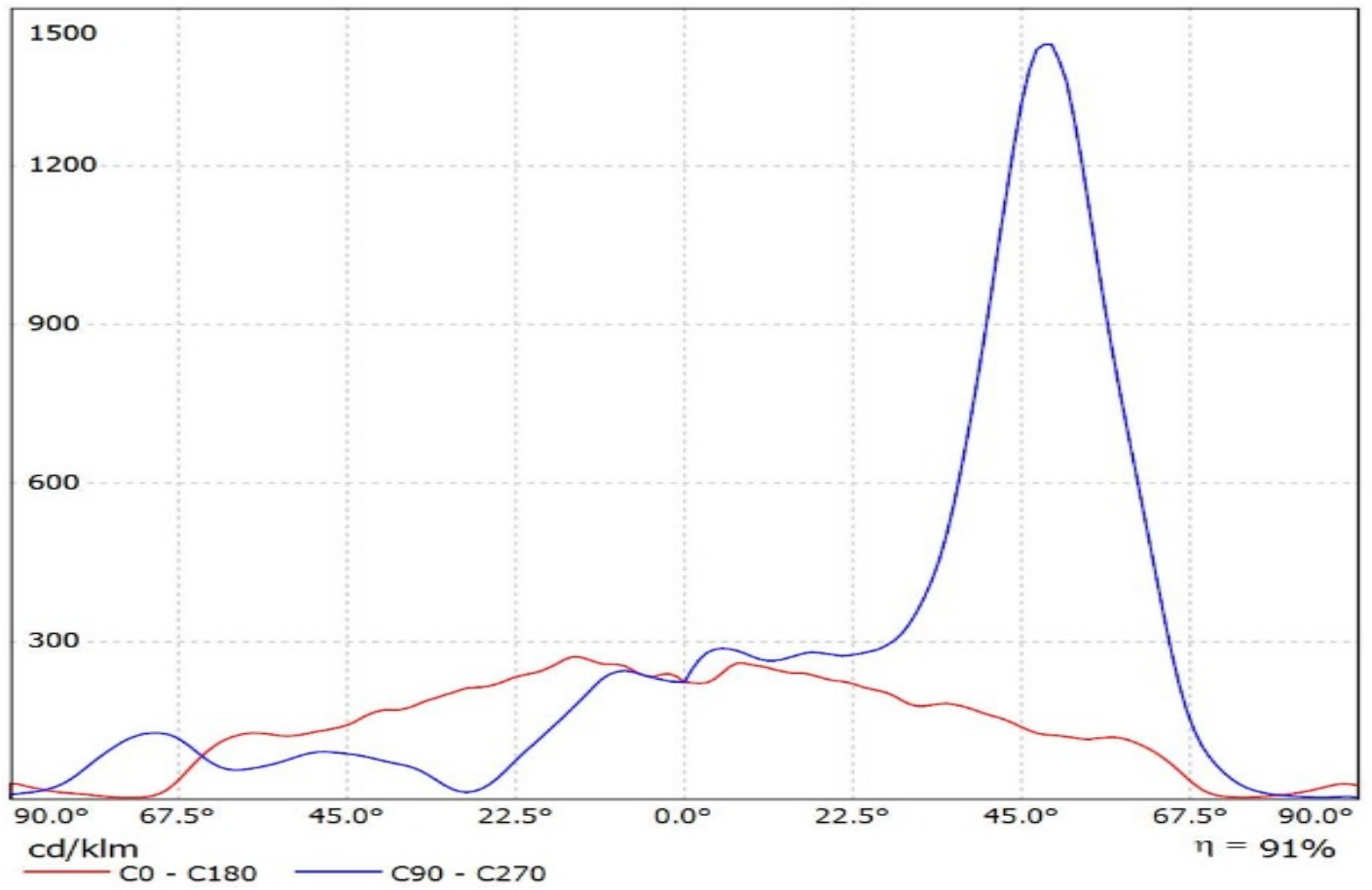

Luminaire: LEDil Oy C13604_STRADA-2X2-FN_(XM-L2) Efficiency=94%
Lamps: 1 x Cree XM-L2 (XMLBWT-0-7B4-T30-0L-0001) 356lm @ 250mA CCT=3200K P=2.8W I=250mA

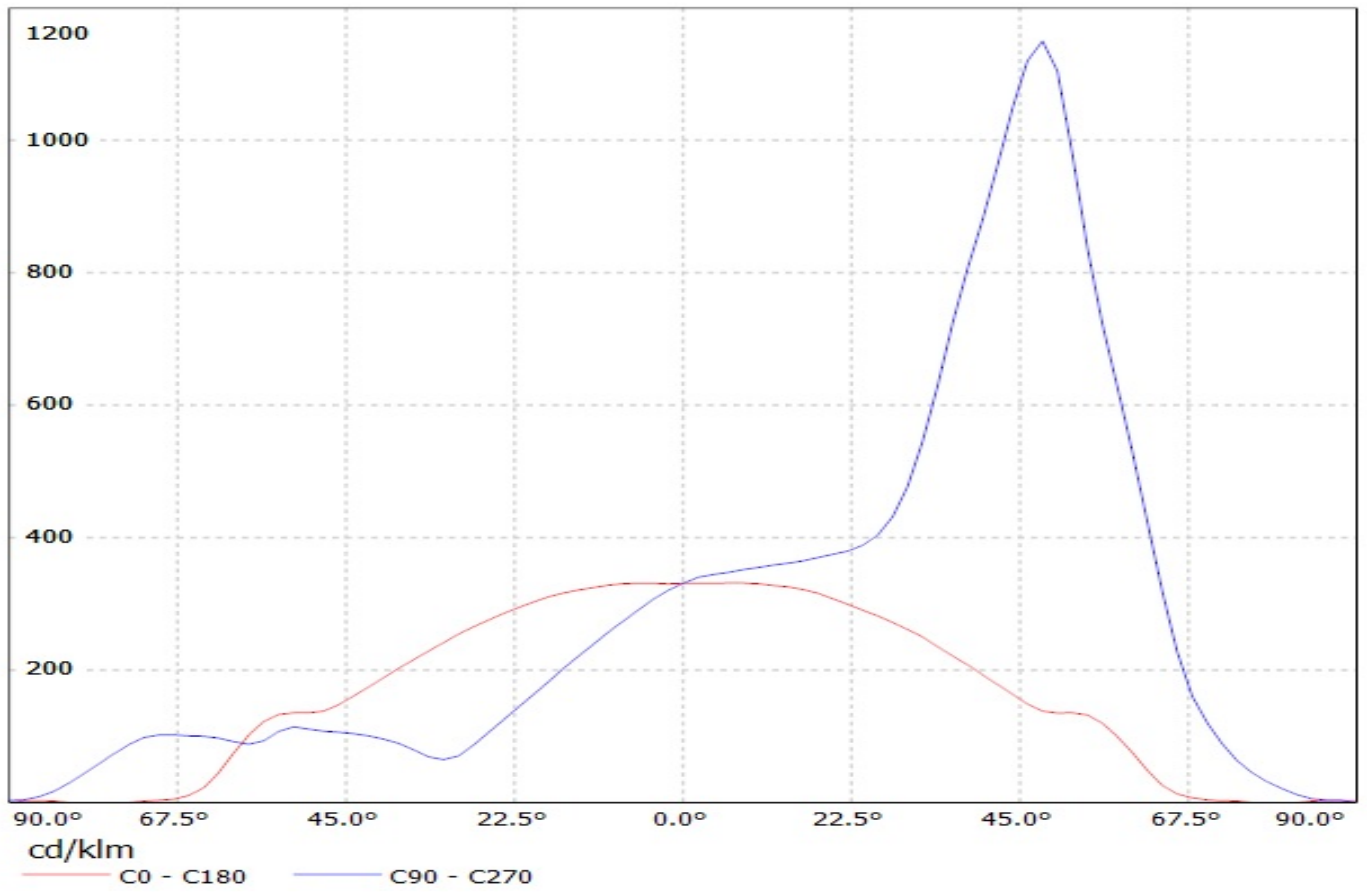

Luminaire: LEDiL Oy C13604_STRADA-2x2-FN_(XP-L)

Lamps: 1 x CREE_XP-L_2x2_(XPLAWT-0-1B0-V40-00-0001)_512.69lm@250mA_CCT=7600K_P=2.79963W_I=249.9mA

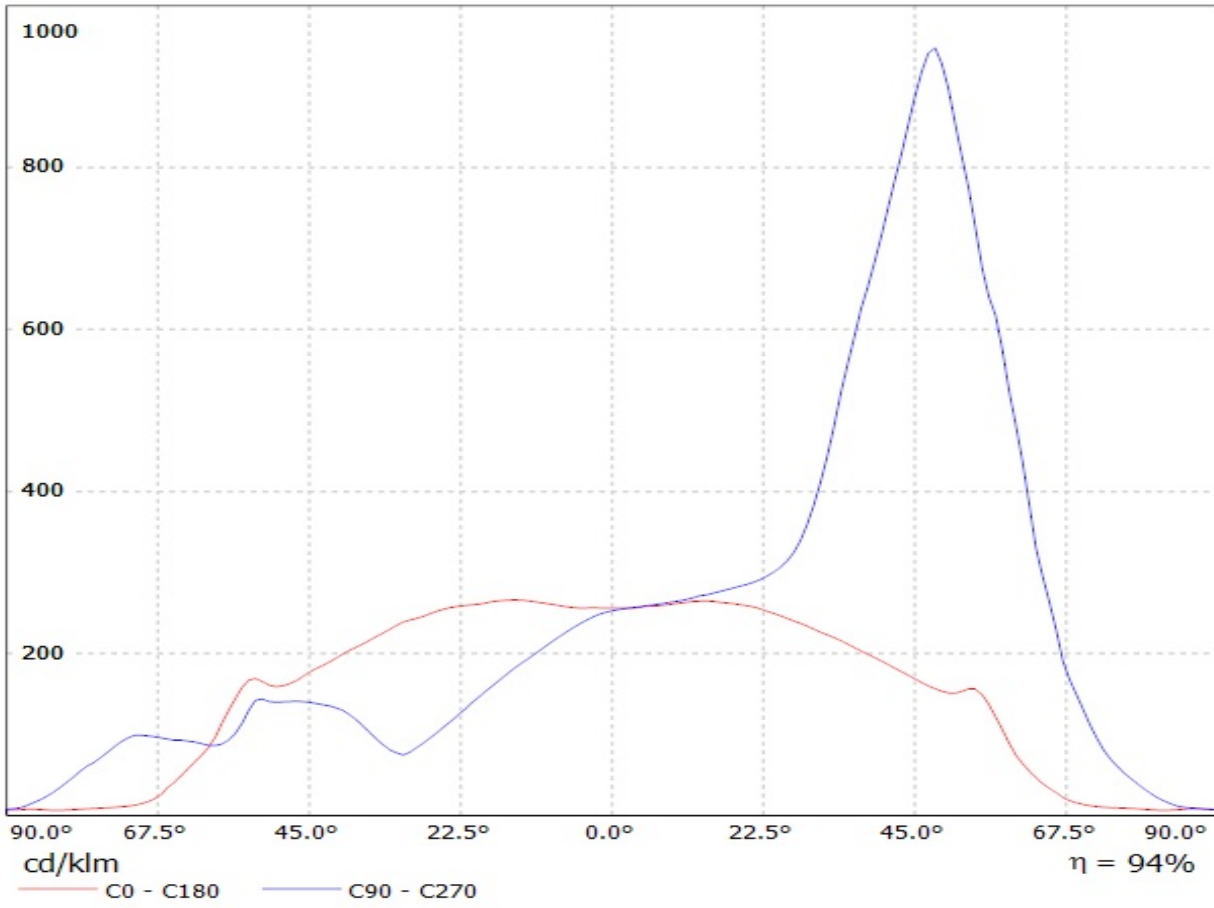

Luminaire: LEDiL Oy C13604_STRADA-2X2-FN_(XP-L_HI)
Lamps: 1 x Cree_XP-L_HI_(2x2)_(XPLAWT-H-5A3-U60-013-0001)
_455.077lm@250mA_P=2.84011W_I=0,2499A

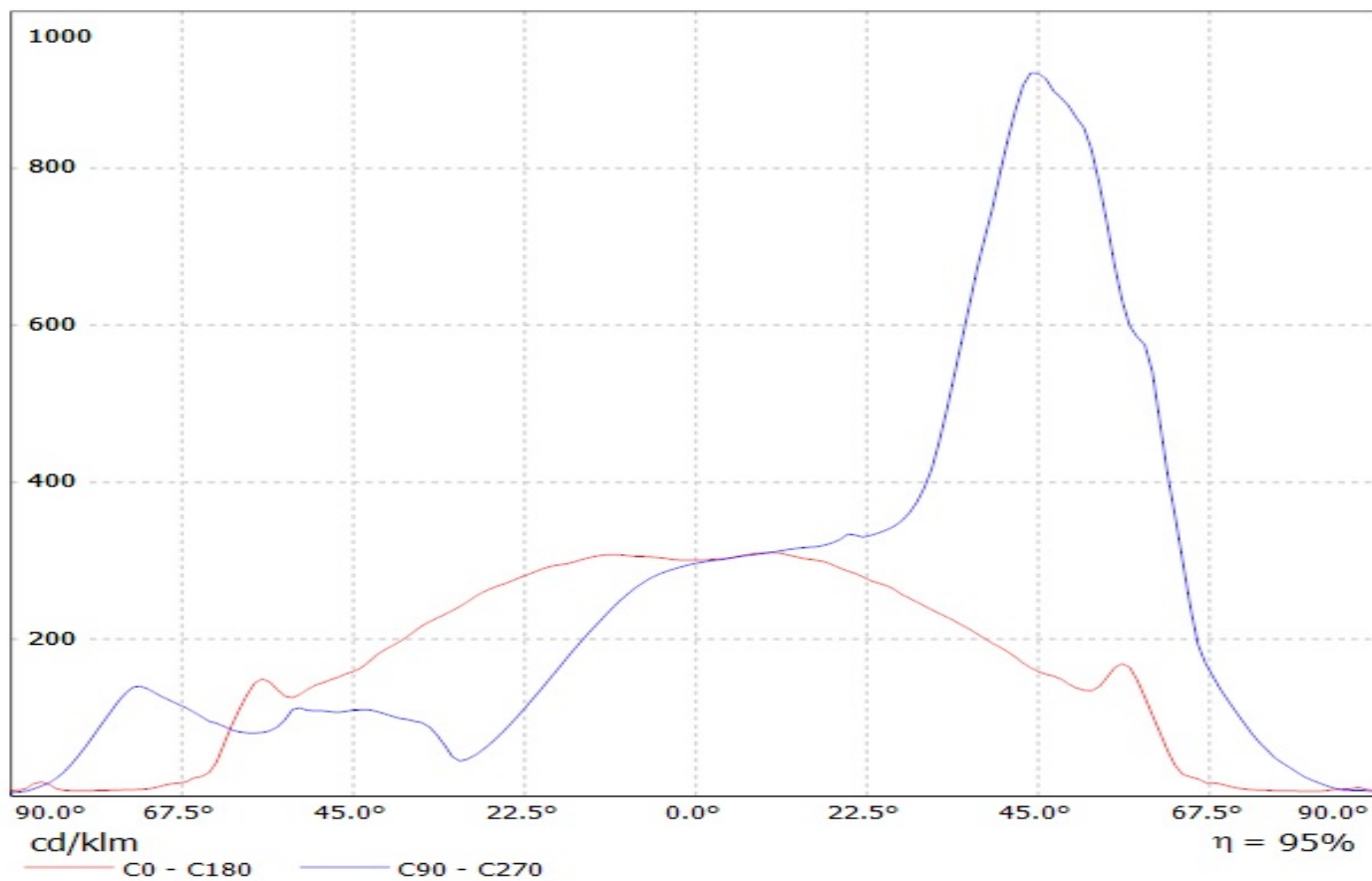

Luminaire: Ledil C13604_STRADA-2x2-FN_(XP-G3)

Lamps: 1 x Cree_XP-G3_2x2_(XPGDWT-B1-3C0-S4-0-01)_516.459lm@250mA_P=2.7885W_I=0.25A

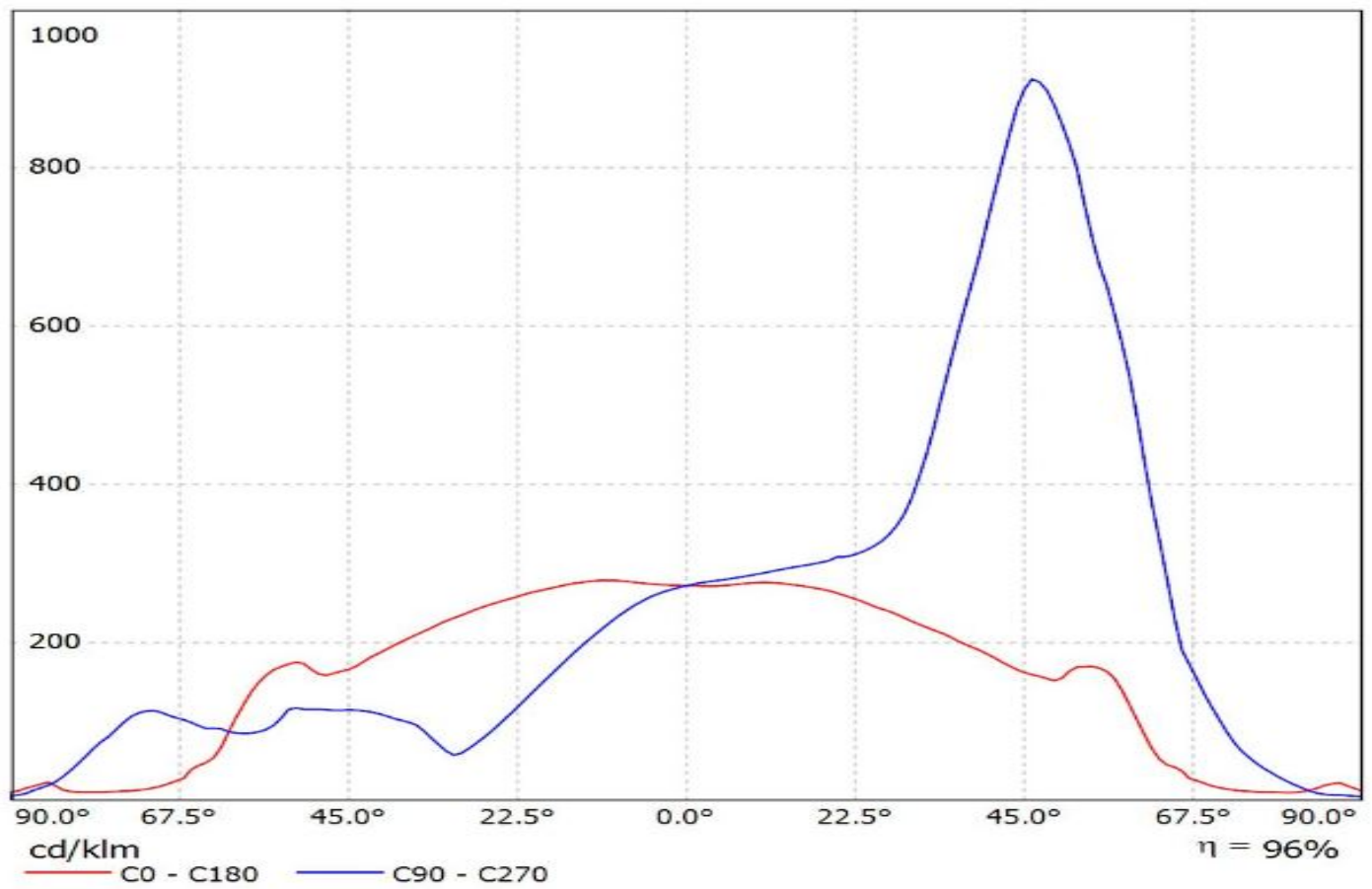

Luminaire: Ledil C13604_STRADA-2X2-FN_(XP-L2)

Lamps: 1 x Cree_XP-L2_2x2_(XPLBWT-00-0000-000BV50E3)550.93lm@250mA_P=2.7815W_I=0.25A

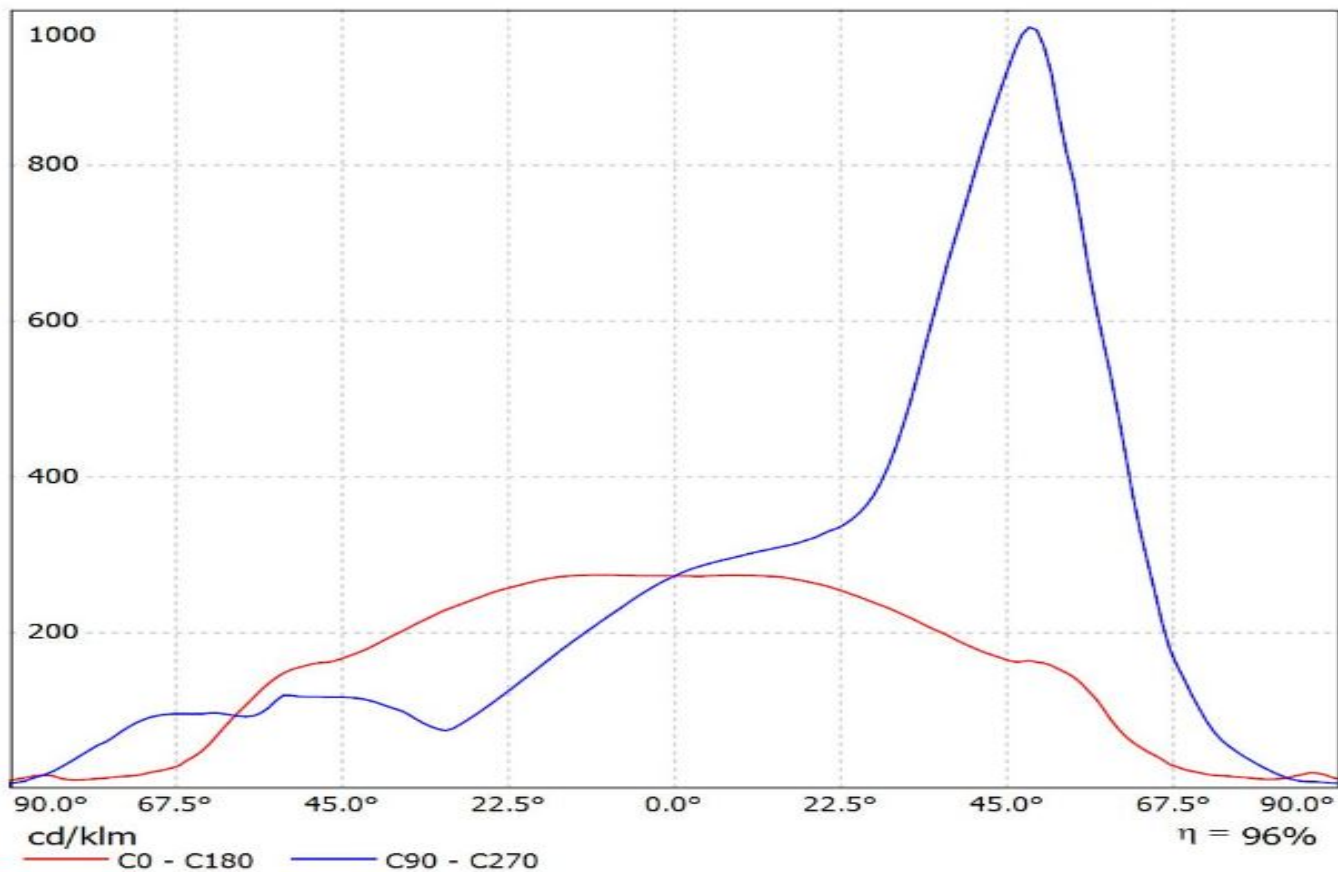

Luminaire: Ledil C13604_STRADA-2X2-FN (H35C1)
Lamps: 1 x LG_H35C1_2x2_477.216lm@250mA_P=2.87475W_I=0.250A

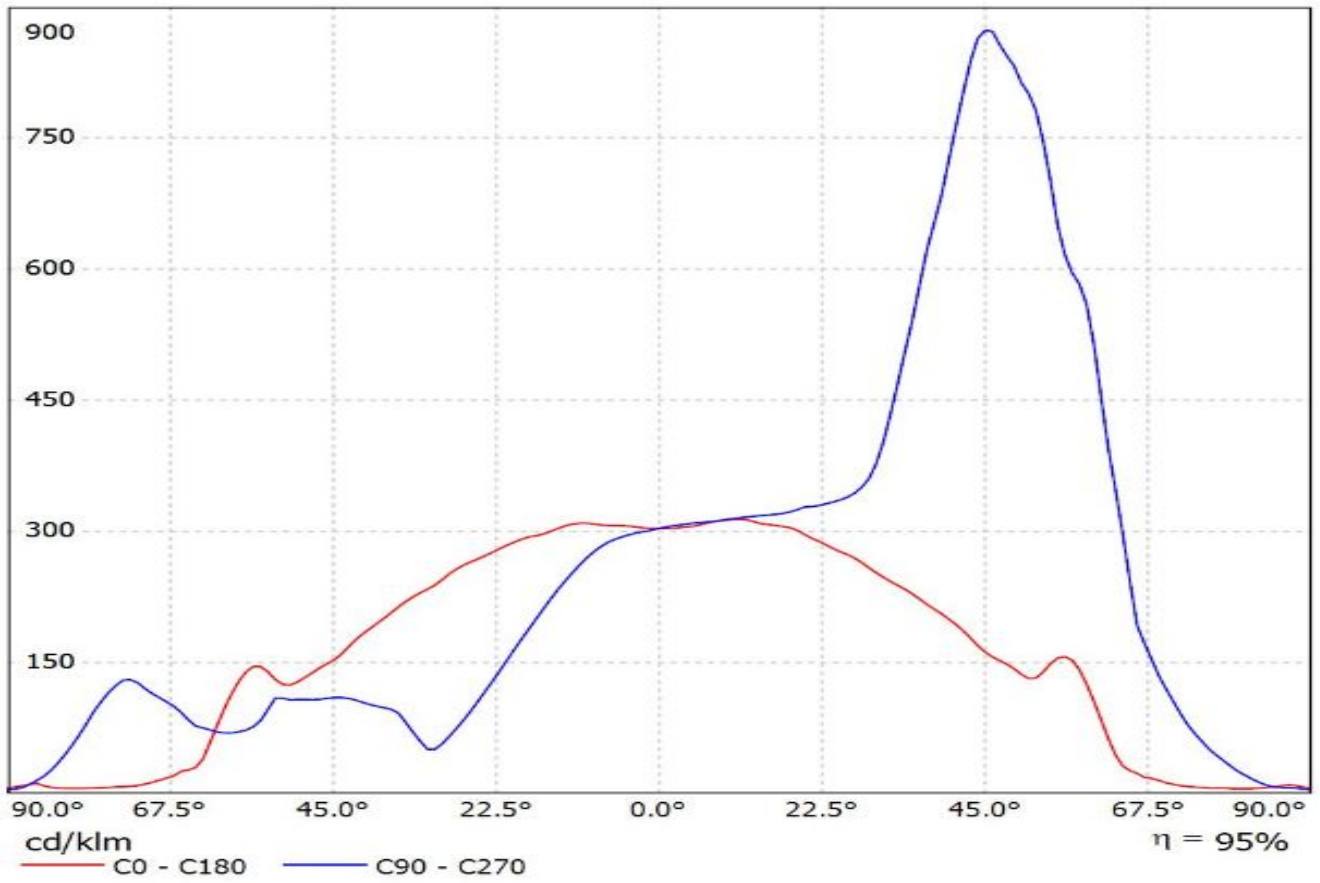

Luminaire: LEDiL Oy C13604_STRADA-2x2-FN_(LUXEON_Q) Eff.95.0%
Lamps: 1 x LUXEON_Q_2x2_(LHQ-3080)_298.615lm@250mA_P=2.86995W_I=249.8mA

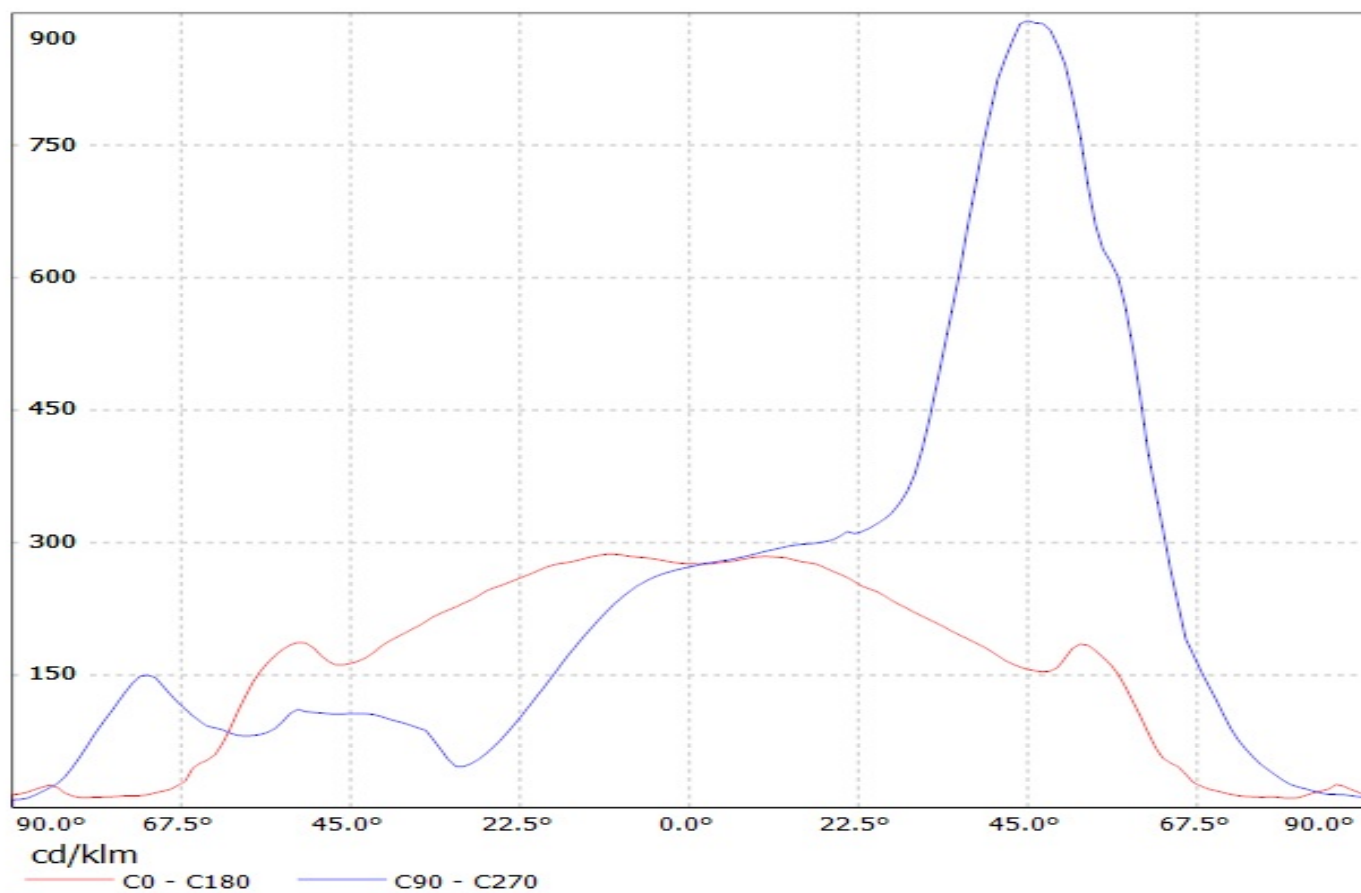

Luminaire: LEDiL Oy C13604_STRADA-2X2-FN_(Luxeon_T) Eff.94%
Lamps: 1 x Luxeon_T_2x2_(LXH8-FW30-3)_289lm@250mA_CCT=3000K_P=2.8W_I=249.9mA

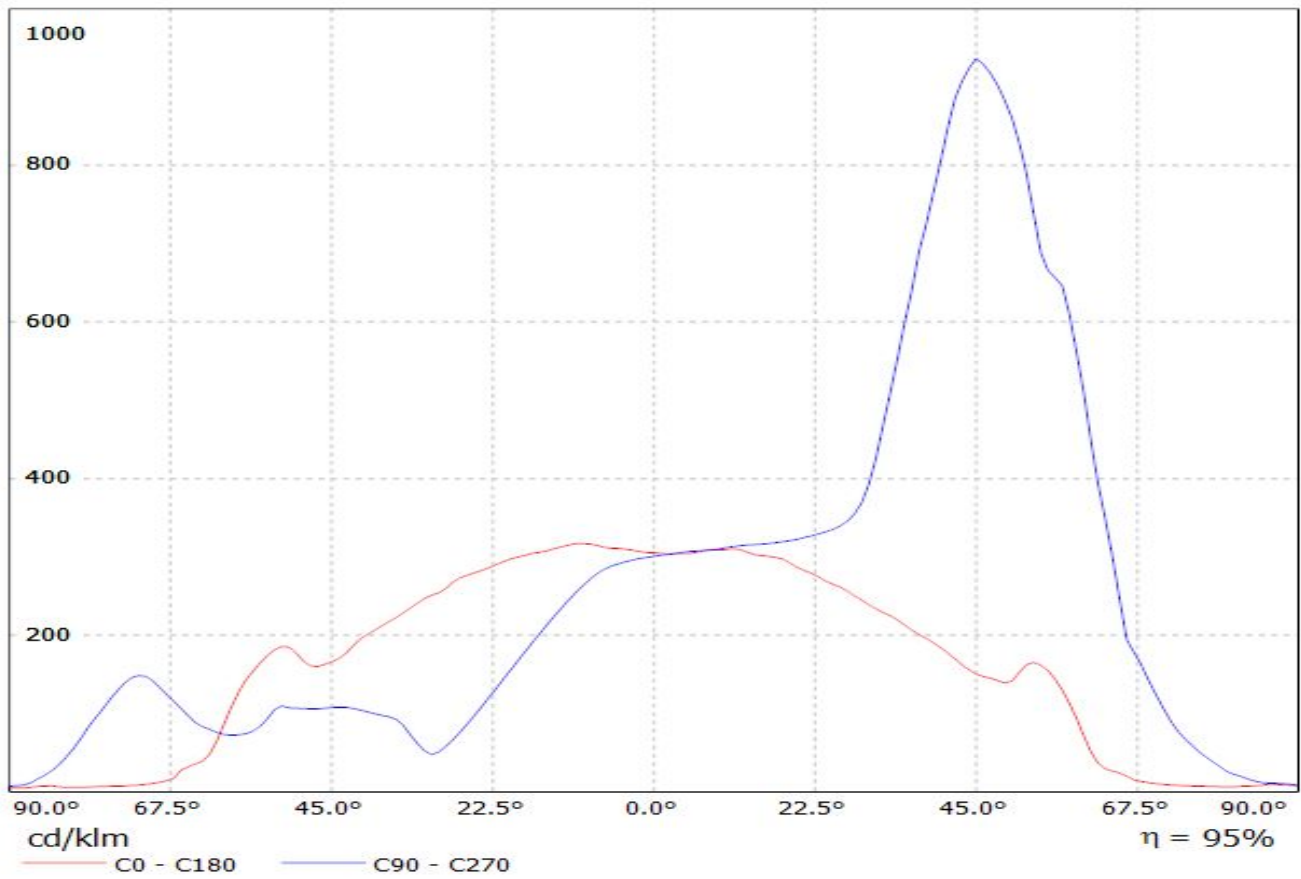

Luminaire: LEDiL Oy C13604_STRADA-2X2-FN_(Luxeon_TX)
Lamps: 1 x Luxeon_TX_321.463lm@250mA_P=2.79513W_I=249.9mA

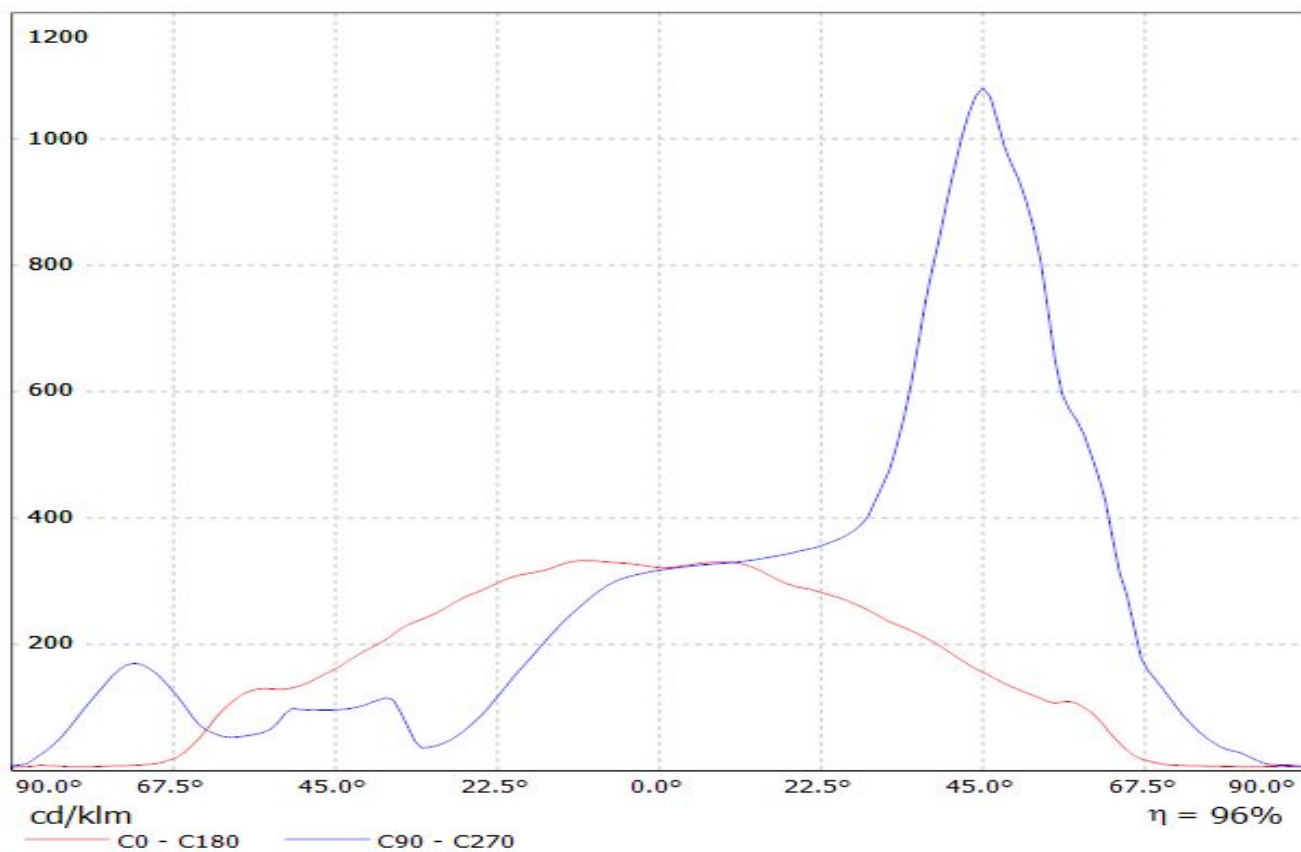

Luminaire: Ledil C13604_STRADA-2X2-FN_(Luxeon_MZ)

Lamps: 1 x Philips_Lumileds_Luxeon_MZ_(LMZ7-QW57)_(2x2)_427.268lm@250mA_P=2.734W_I=0.2500A

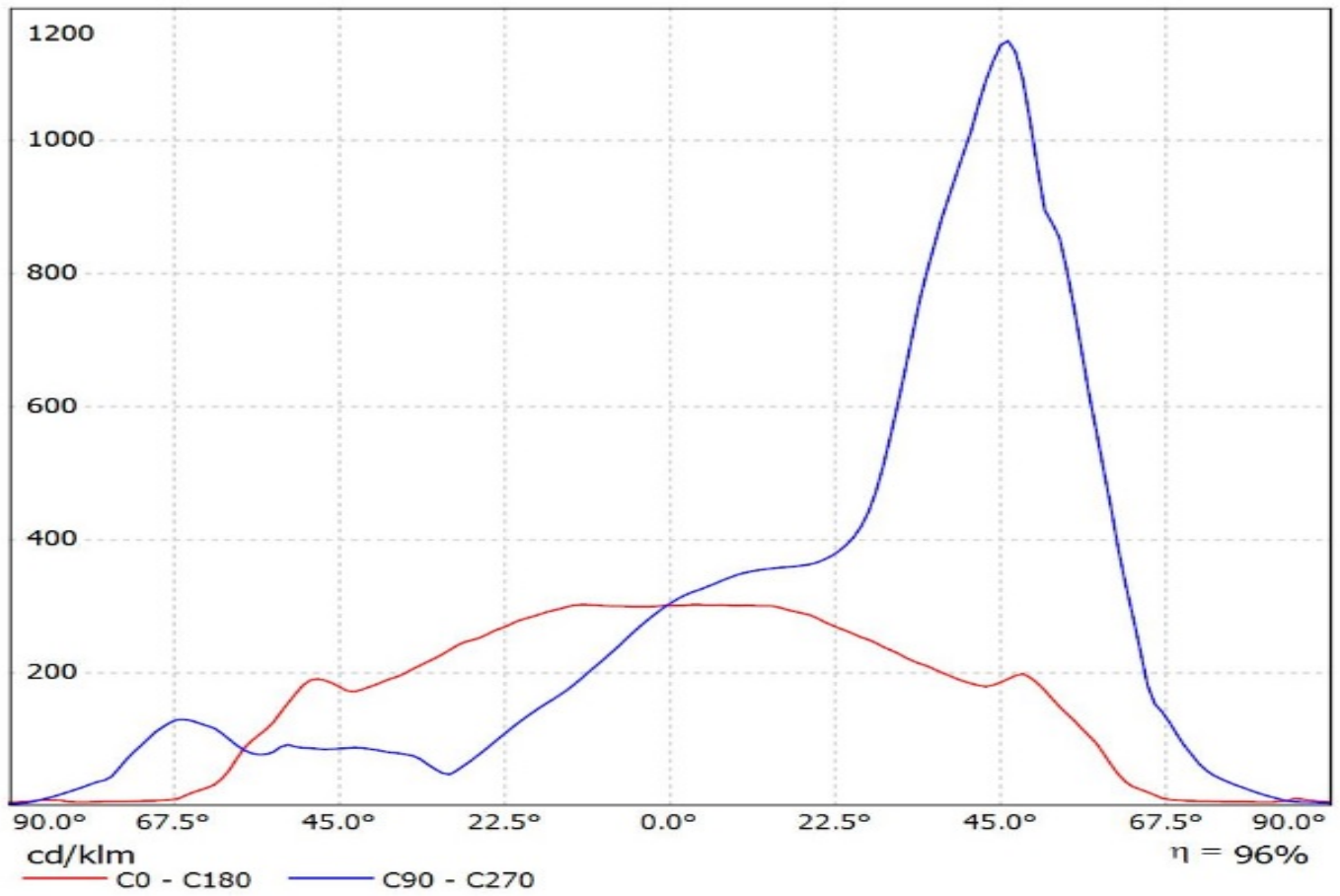

Luminaire: Ledil C13604-Strada-2x2-FN_(NVSL219CE)

Lamps: 1 x Nichia_NVSL219CE_496.405lm@250mA_CCT=4000K_P=2.8465W_I=0.25A

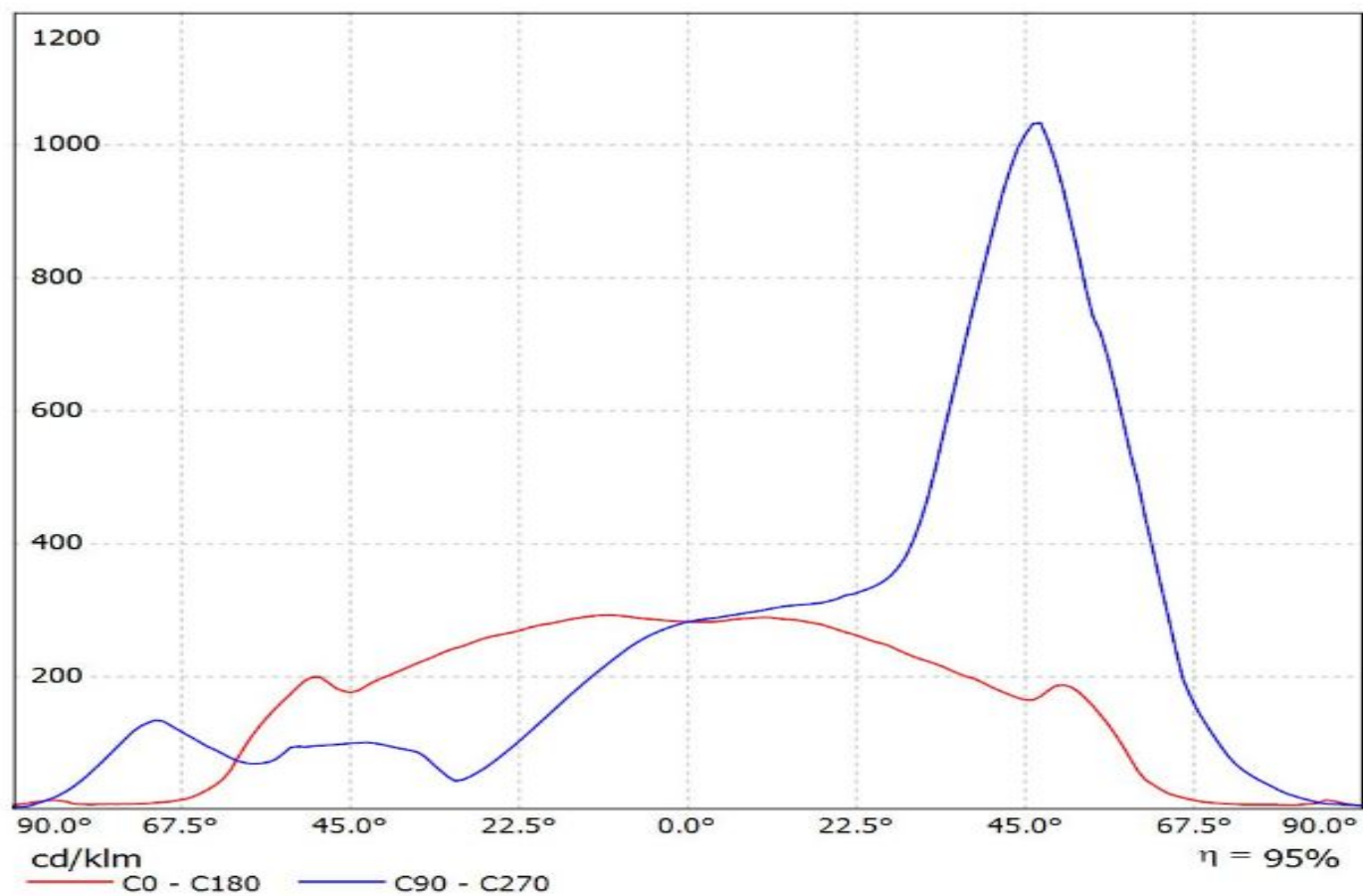

Luminaire: LEDiL Oy C13604_STRADA-2X2-FN_(E21A)
Lamps: 1 x Nichia_E21A_2X2_454.11lm@250mA_P=2.81W_I=0.250A

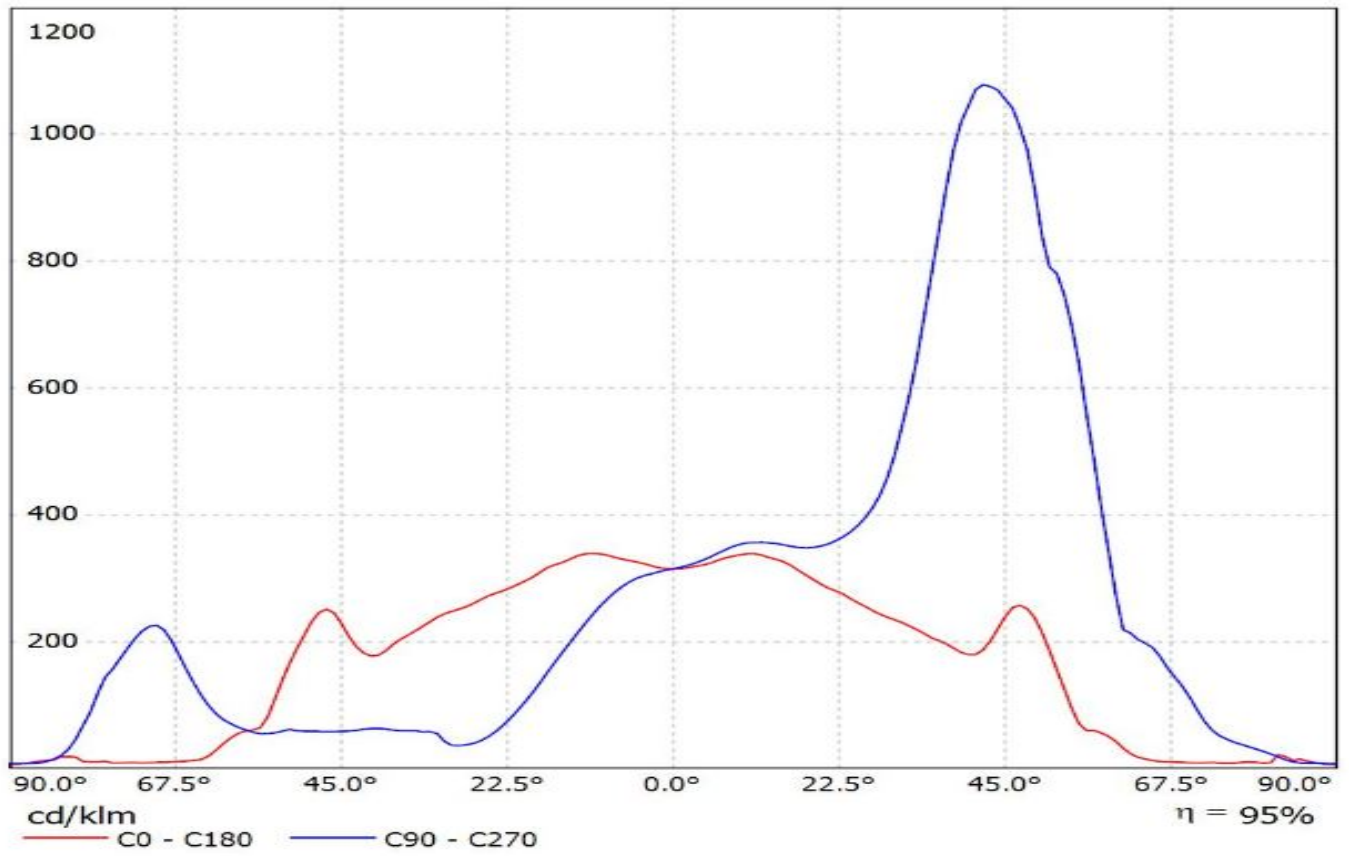

Luminaire: LEDiL Oy C13604_STRADA-2X2-FN_(NVSW319AE)
Lamps: 1 x Nichia_NVSW319AE_499.093lm@250mA_P=2.79052W_I=0.25A

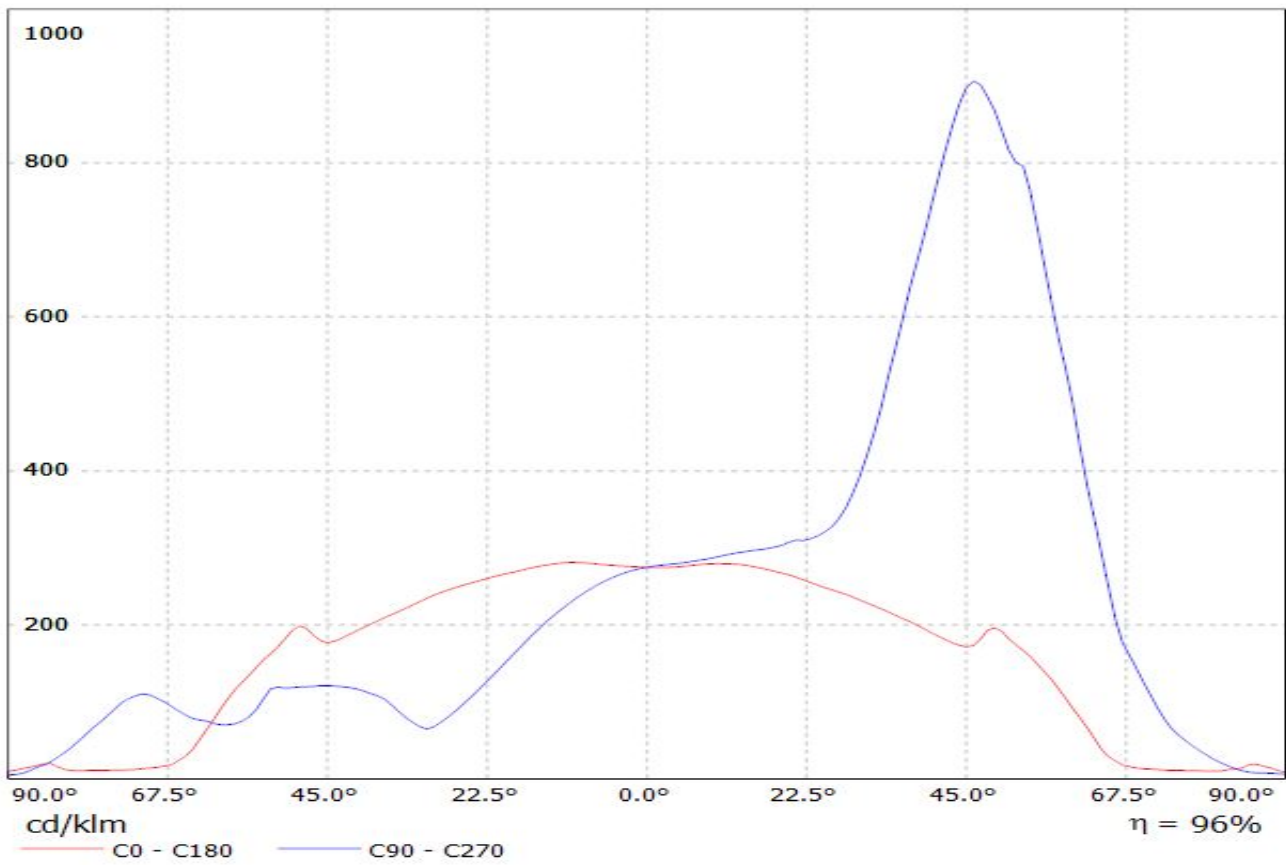

Luminaire: Ledil Oy C13604_STRADA-2X2-FN_(NWSx229A)_SIMULATED
Lamps: 1 x Nichia NWSW229A

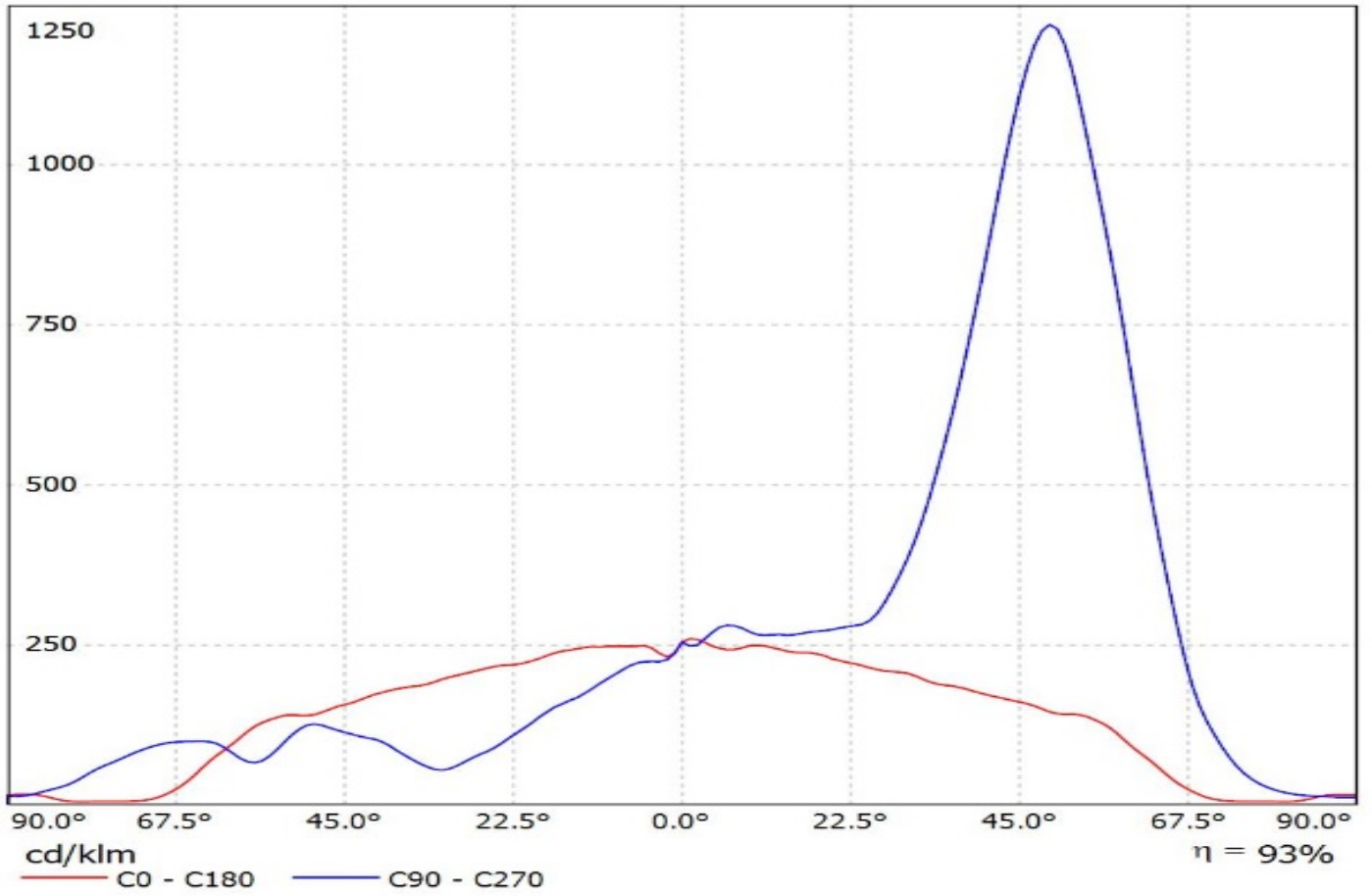

Ledil C13604_STRADA-2X2-FN_(SQ-PC) / LDC (Linear)

Luminaire: Ledil C13604_STRADA-2X2-FN_(SQ-PC)
Lamps: 1 x Osram_Oslon_Square-PC_2x2_(GW_CSSRM1.PC)
_423.267lm@250mA_CCT=5201K_P=2.86W_I=0.25A

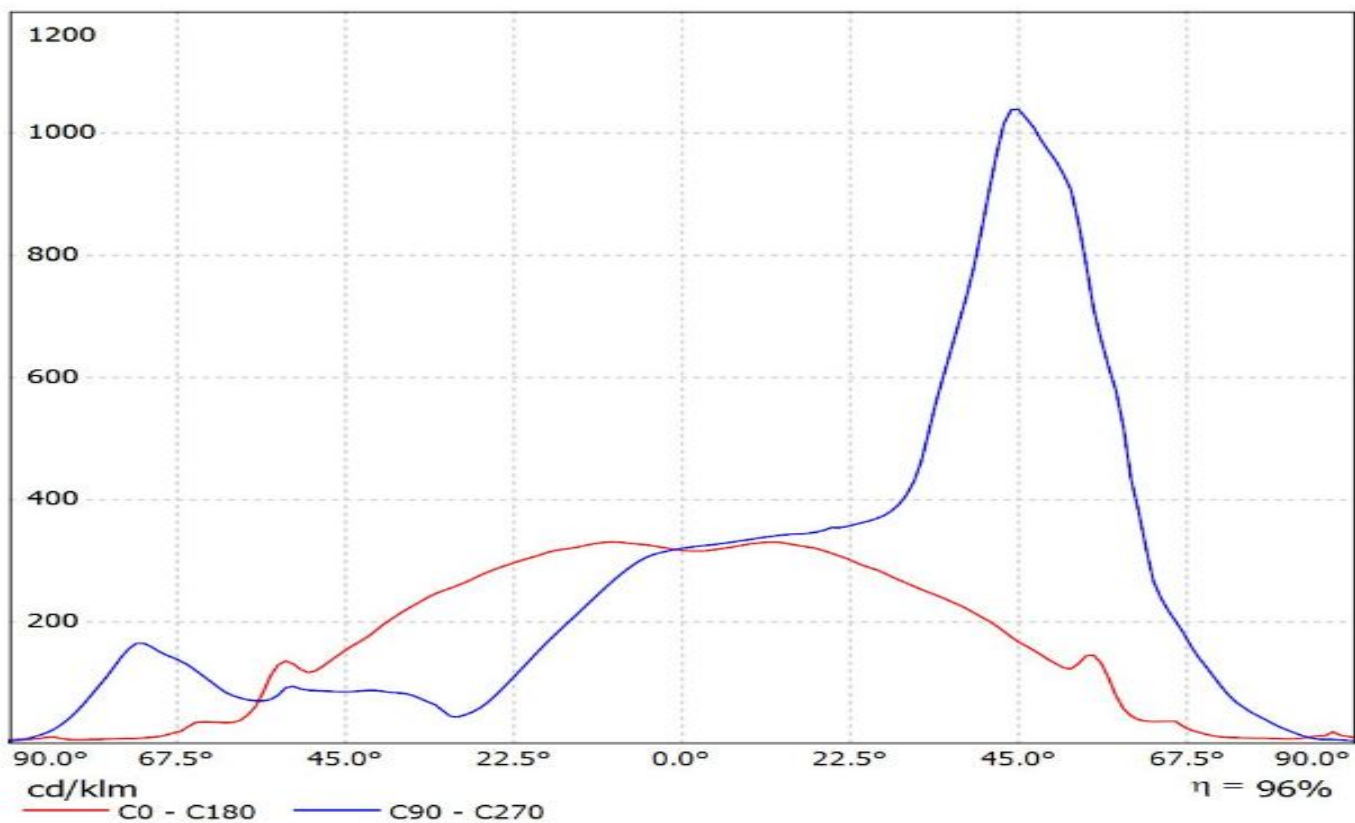

Luminaire: LEDiL Oy
Lamps: 1 x C13604_Strada-2x2-FN_(SQ_Gen3)

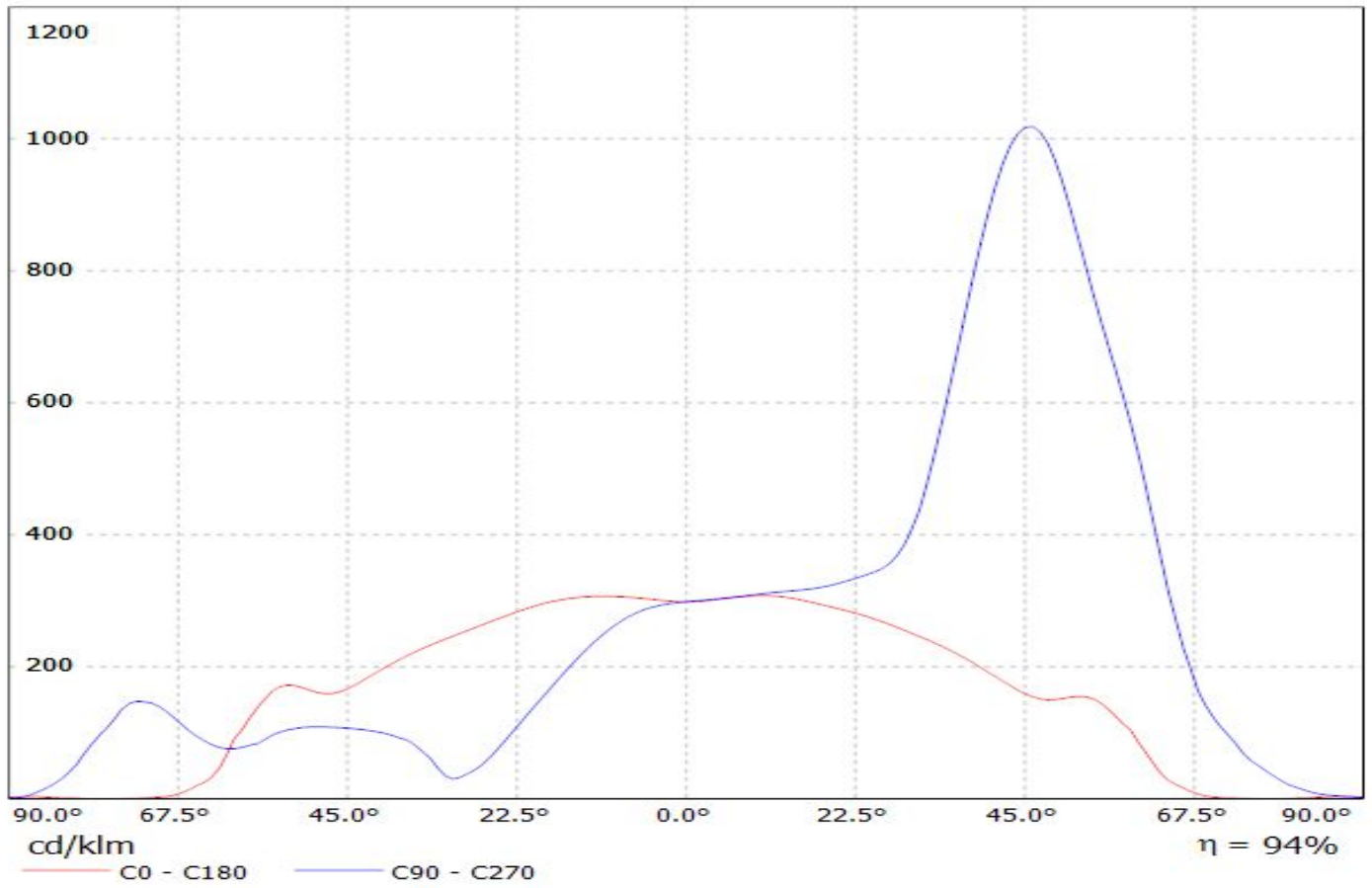

Luminaire: Ledil Oy C13604_STRADA-2X2-FN_(Duris_P8)_SIMULATED
Lamps: 1 x Osram Duris P8 (GW PUSRA1.PM)

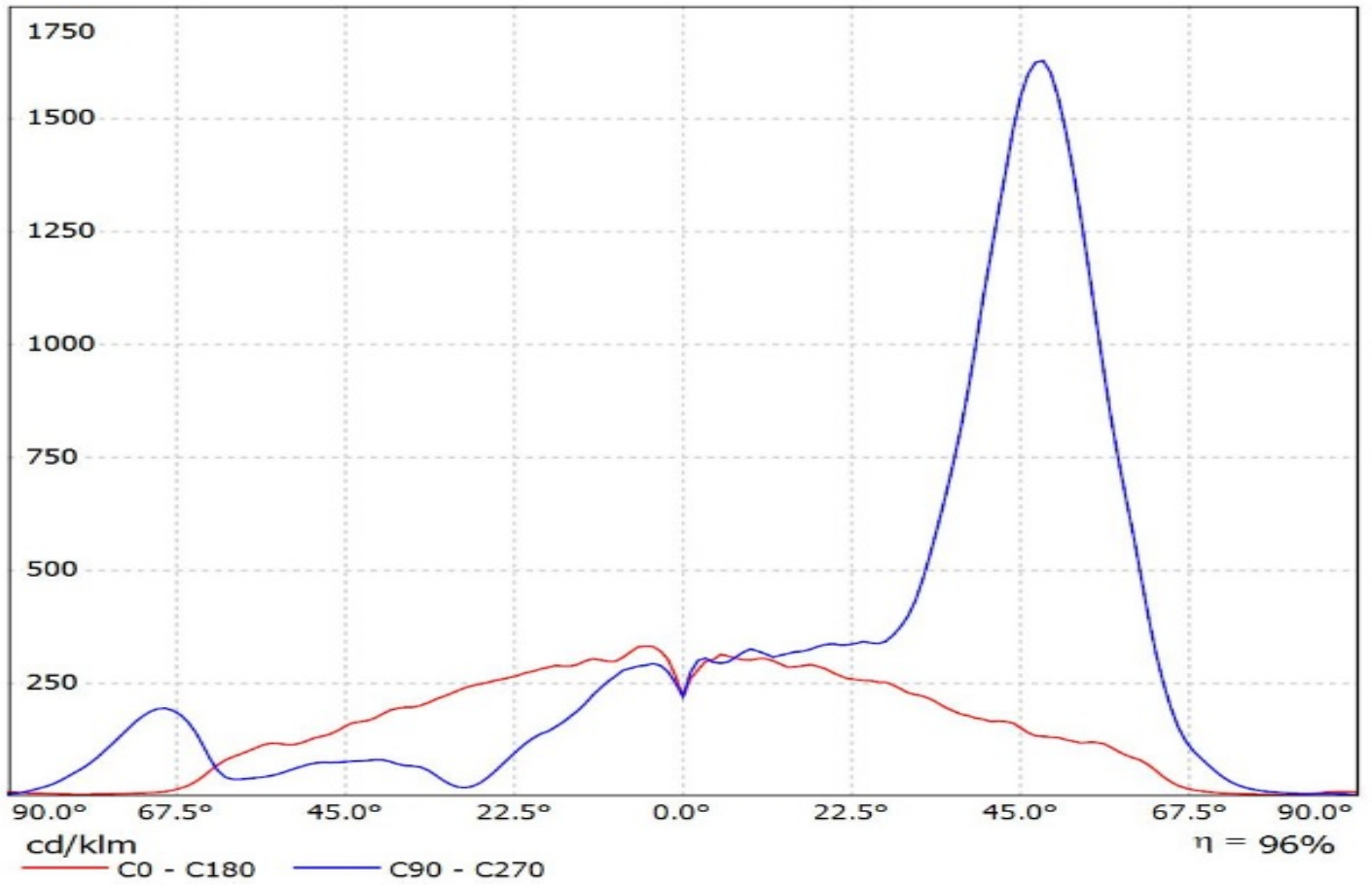

Luminaire: Ledil C13604_STRADA-2X2-FN (Fortimo_FastFlex_LED_board_2x8/740_DA_G3)
Lamps: 1 x Fortimo_FastFlex_LED_board_2x8/740_DA_G3_1828.23lm@250mA_P=11.667W_I=0.25A

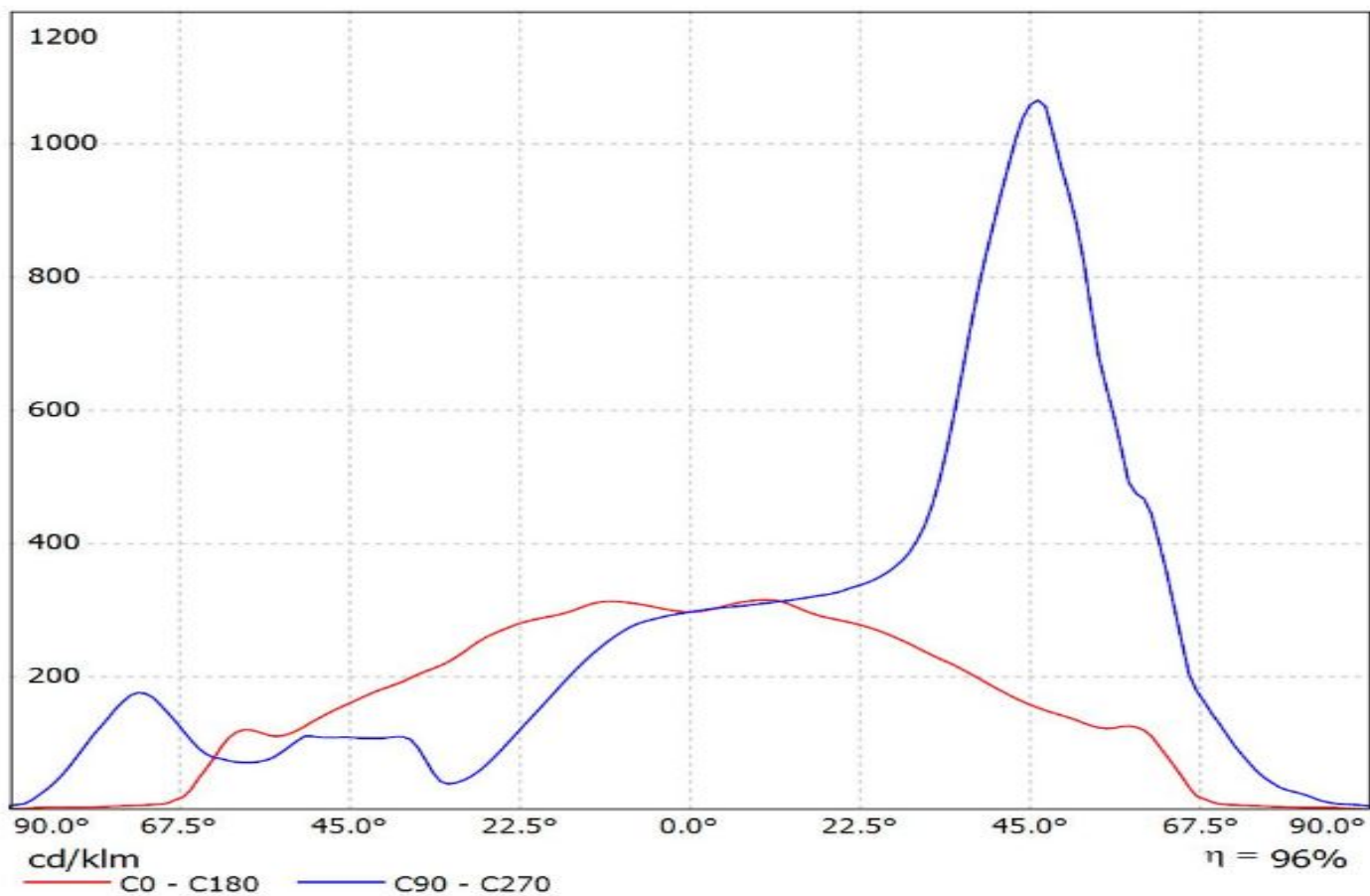

Luminaire: Ledil C13604_STRADA-2X2-FN_(LH351B)

Lamps: 1 x Samsung_LH351B_2x2_444.178lm@250mA_P=2.8535W_I=0.25A

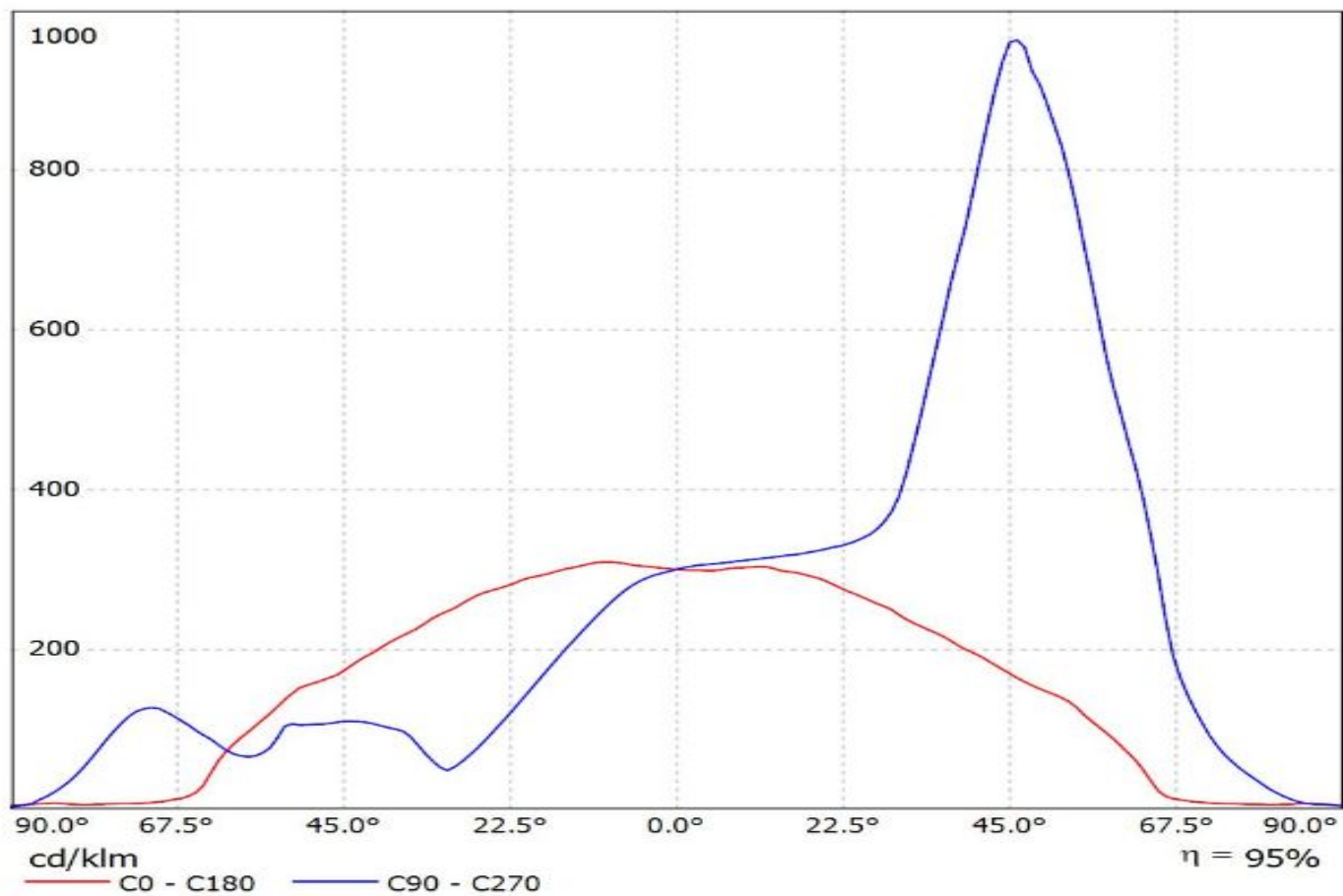

Luminaire: Ledil C13604_STRADA-2X2-FN_(LH351B)_GS_Glass
Lamps: 1 x Samsung_LH351B_2x2_442.633lm@250mA_P=2.851W_I=0.25A

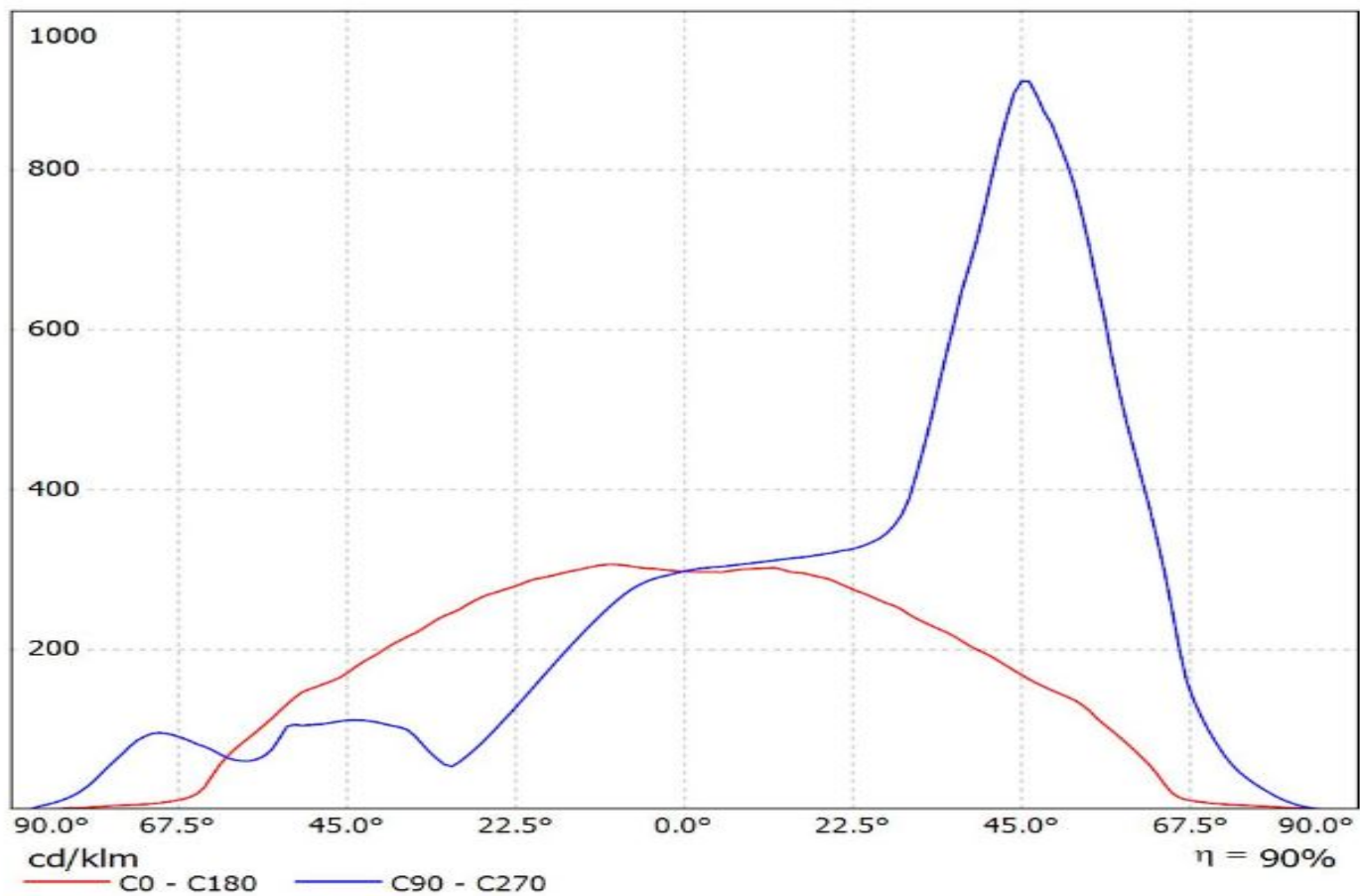

Luminaire: LEDil Oy C13604_STRADA-2X2-FN_(Z5M1) Efficiency=94%
Lamps: 1 x Seoul Z5M1 (SZ5-M1-WN-C8) 379lm @ 250mA CCT=4600K P=2.9W I=250mA

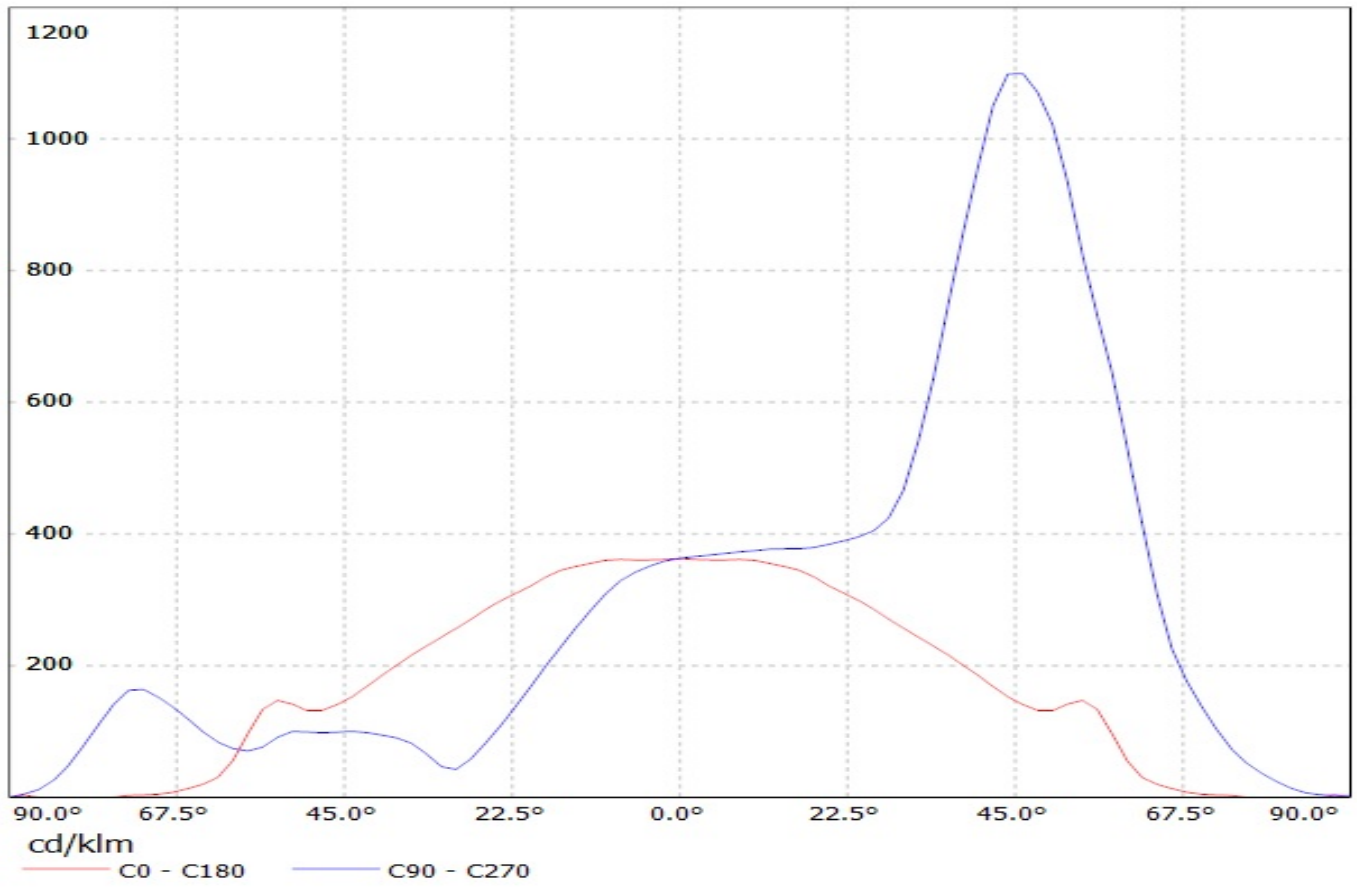

Ledil C13604_STRADA-2X2-FN_(TL1L3) / LDC (Linear)

Luminaire: Ledil C13604_STRADA-2X2-FN_(TL1L3)

Lamps: 1 x Toshiba_TL1L3_2x2_(TL1L3-NW1.L)_387.773lm@250mA_CCT=5000K_P=2.829W_I=0.25A

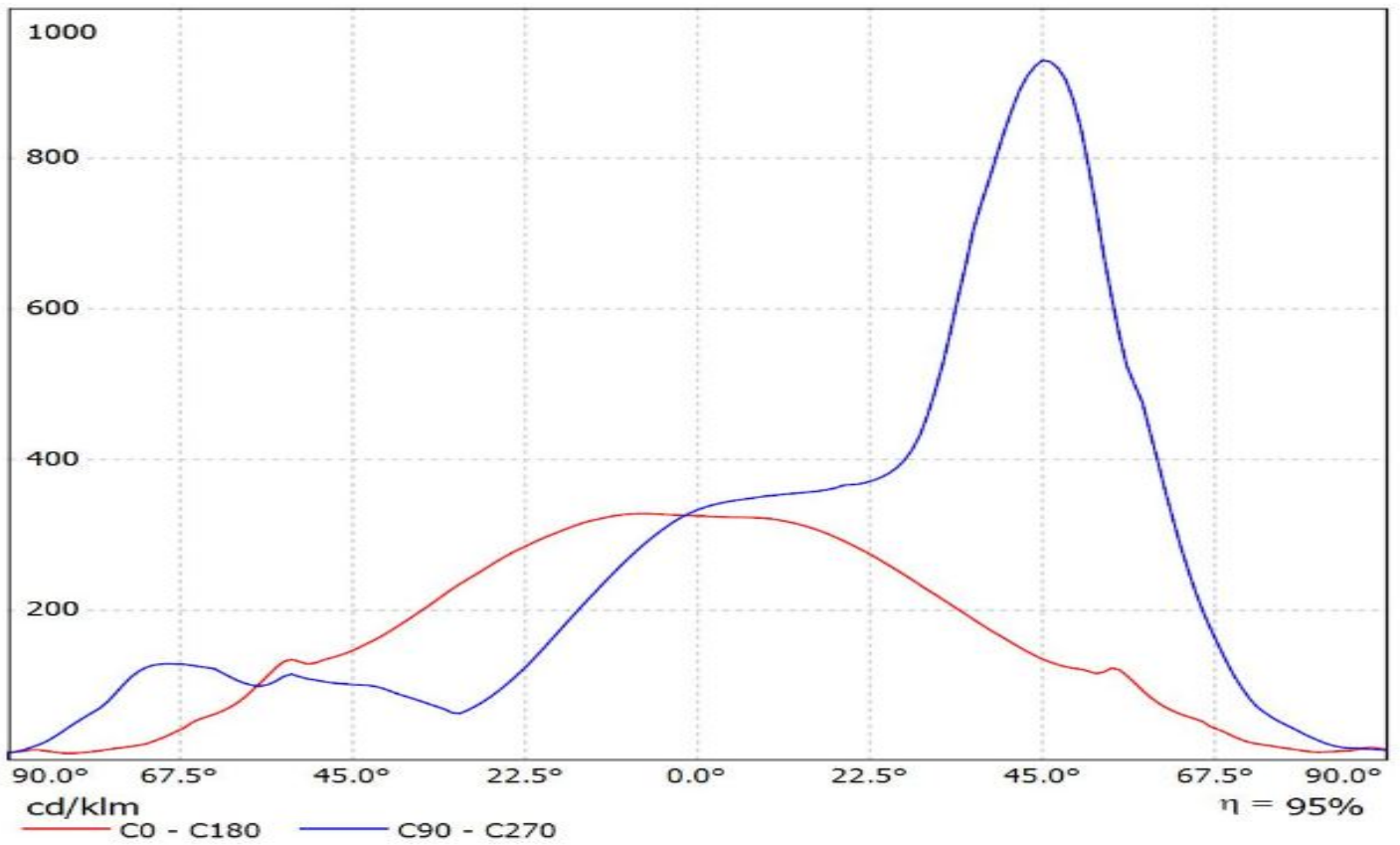

Ledil C13604_STRADA-2X2-FN_(TL1L4) / LDC (Linear)

Luminaire: Ledil C13604_STRADA-2X2-FN_(TL1L4)

Lamps: 1 x Toshiba_TL1L4_2x2_(TL1L4-DW0)_472.639lm@250mA_CCT=6500K_P=2.9W_I=0.25A

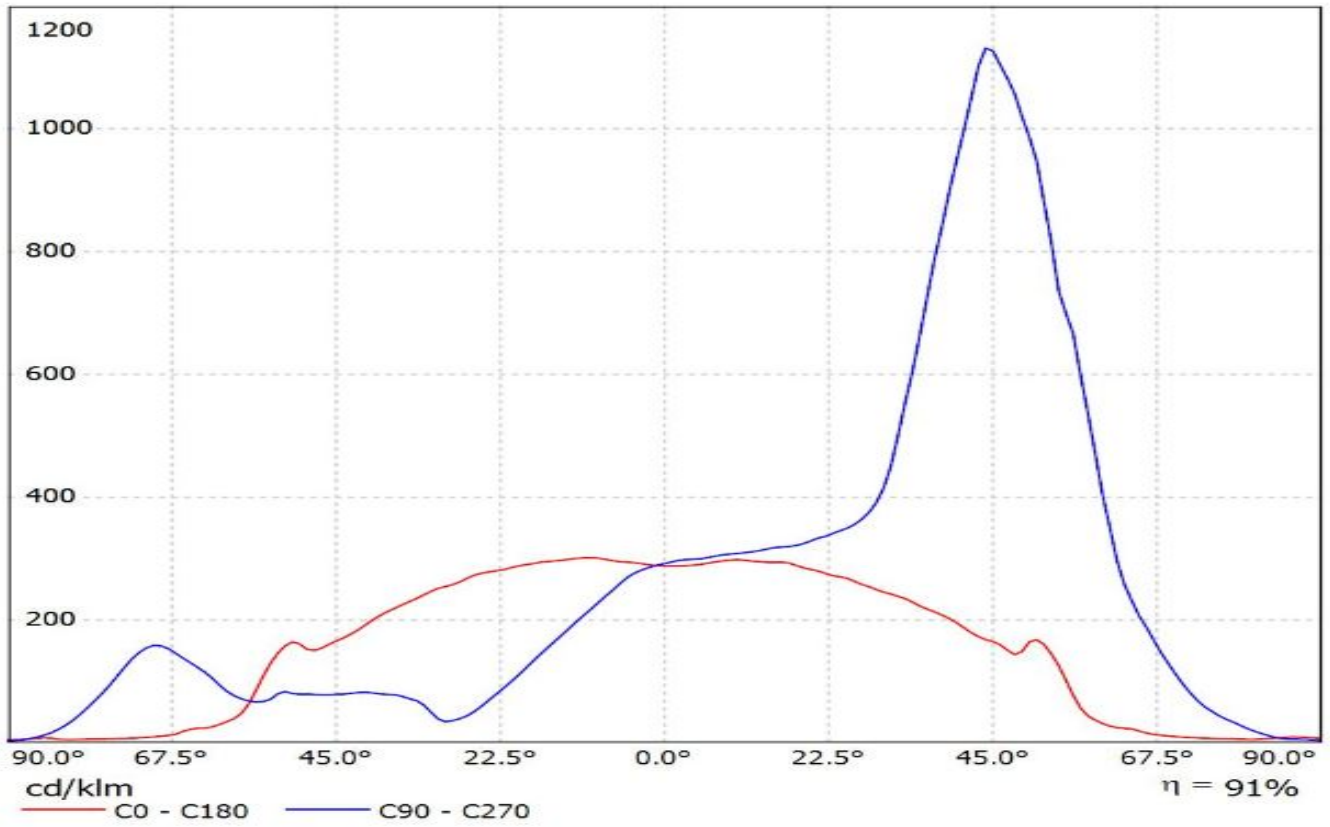

Luminaire: LEDiL Oy C13604_STRADA-2X2-FN_(Tridonic_Module_RLE_G1)
Lamps: 1 x Tridonic_Module_RLE_G1_4576.03lm@700mA_P=32.0681W_I=0.700A

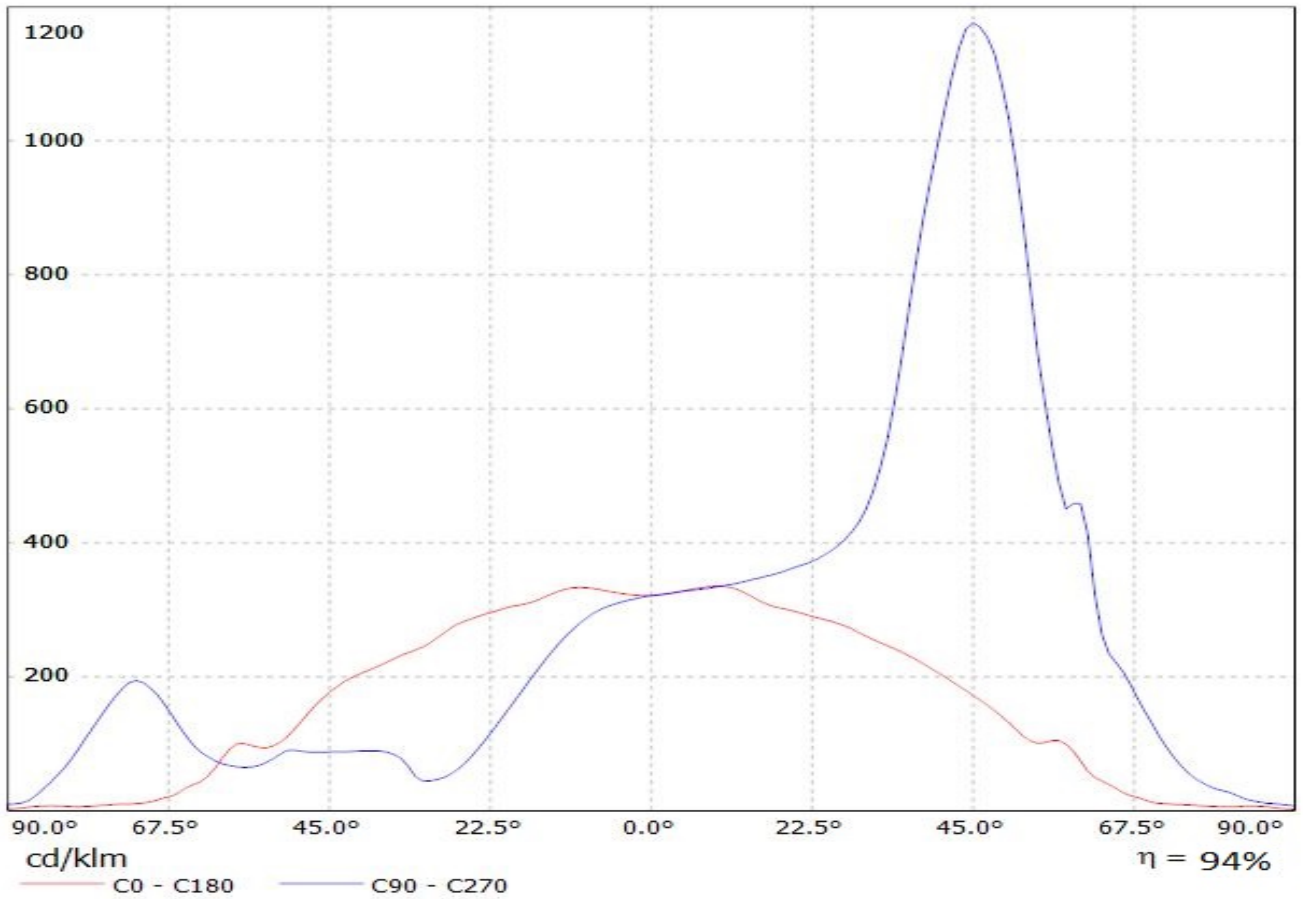

Luminaire: LEDiL Oy C13604_STRADA-2X2-FN_(Tridonic_Module_RLE_G1)
Lamps: 1 x Tridonic_Module_RLE_G1_4576.03lm@700mA_P=32.0681W_I=0.700A

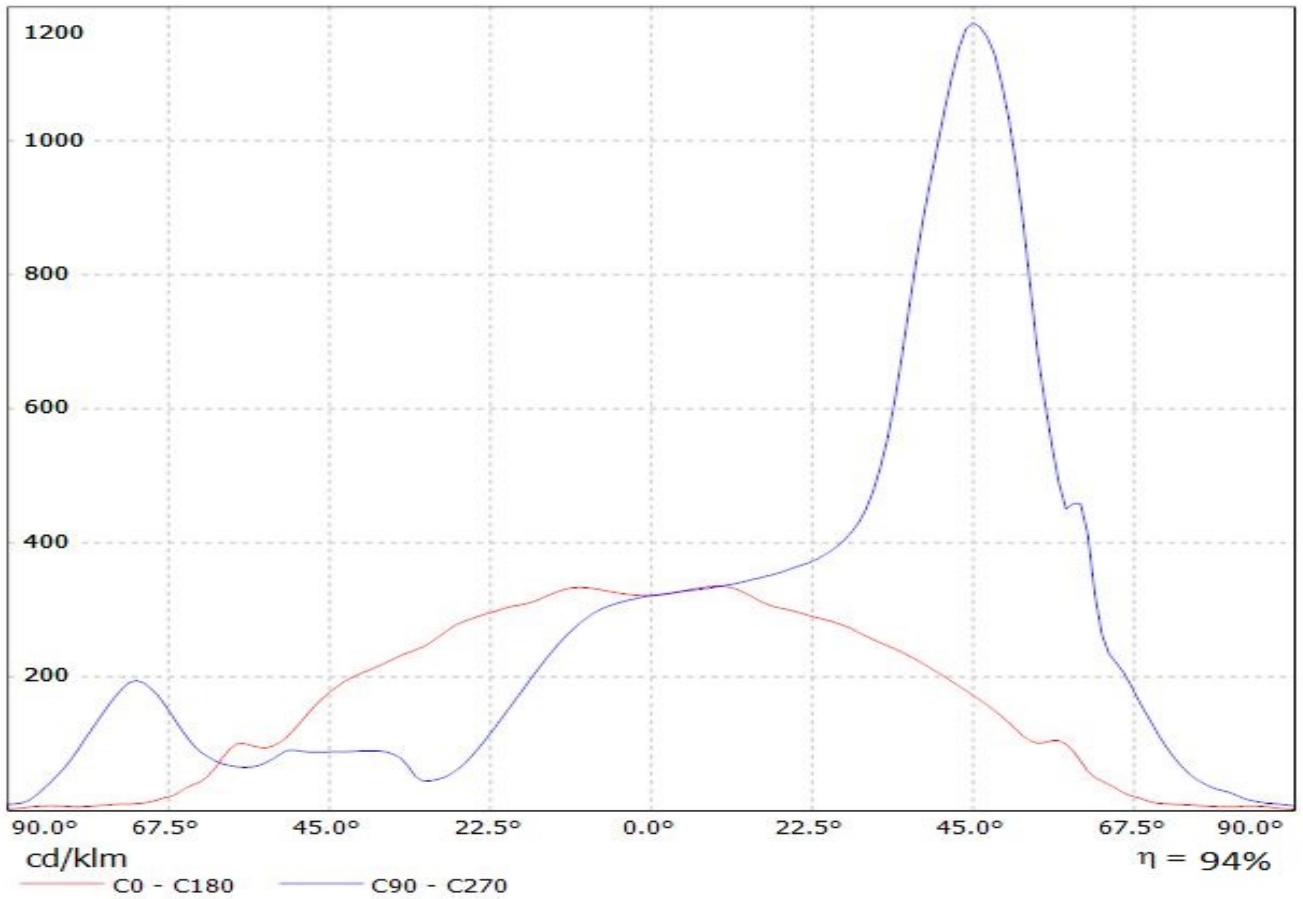

Luminaire: LEDiL Oy C13604_STRADA-2X2-FN_(Tridonic_Module_RLE_G1)
Lamps: 1 x Tridonic_Module_RLE_G1_2288lm@700mA_P=16W_I=0.700A

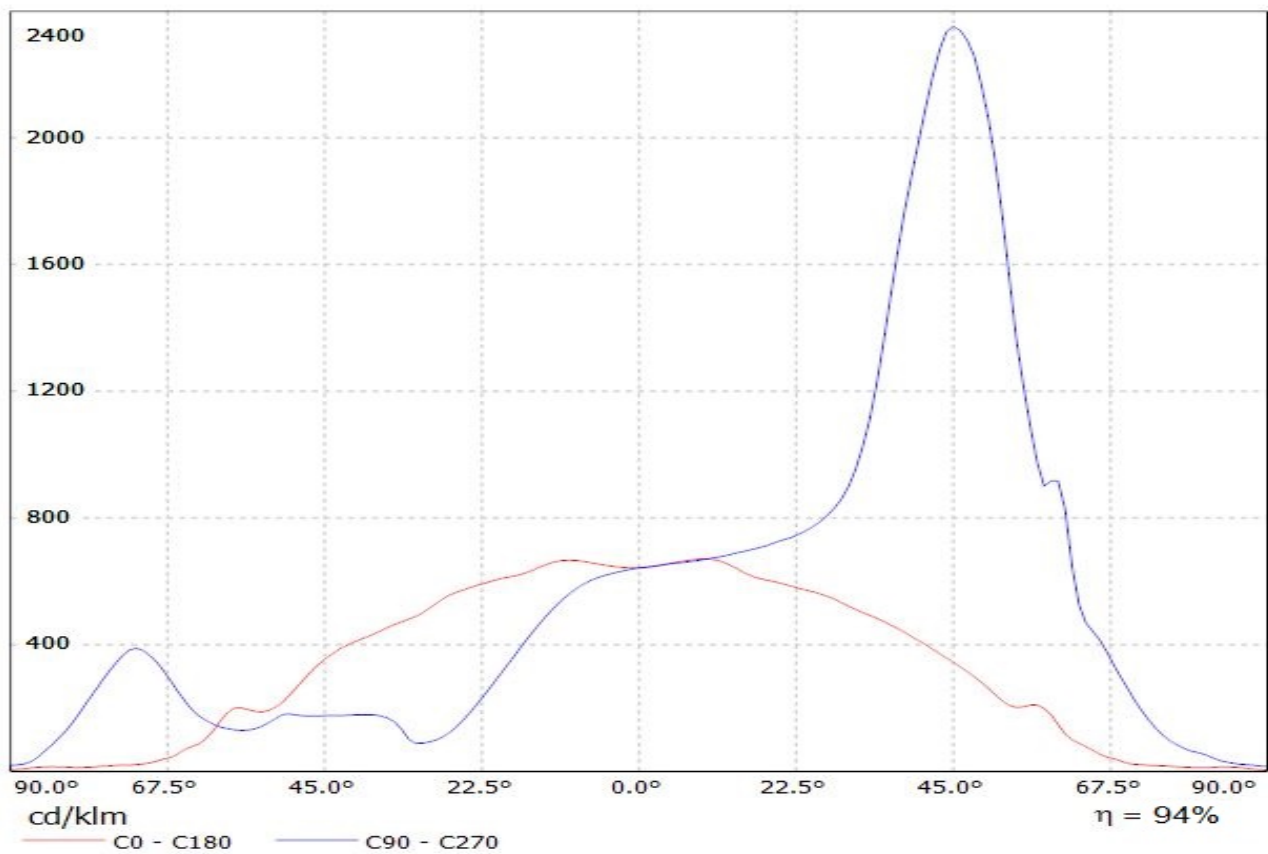

Luminaire: LEDiL Oy C13604_STRADA-2X2-FN_(Tridonic_Module_RLE_G1)
Lamps: 1 x Tridonic_Module_RLE_G1_2288lm@700mA_P=16W_I=0.700A

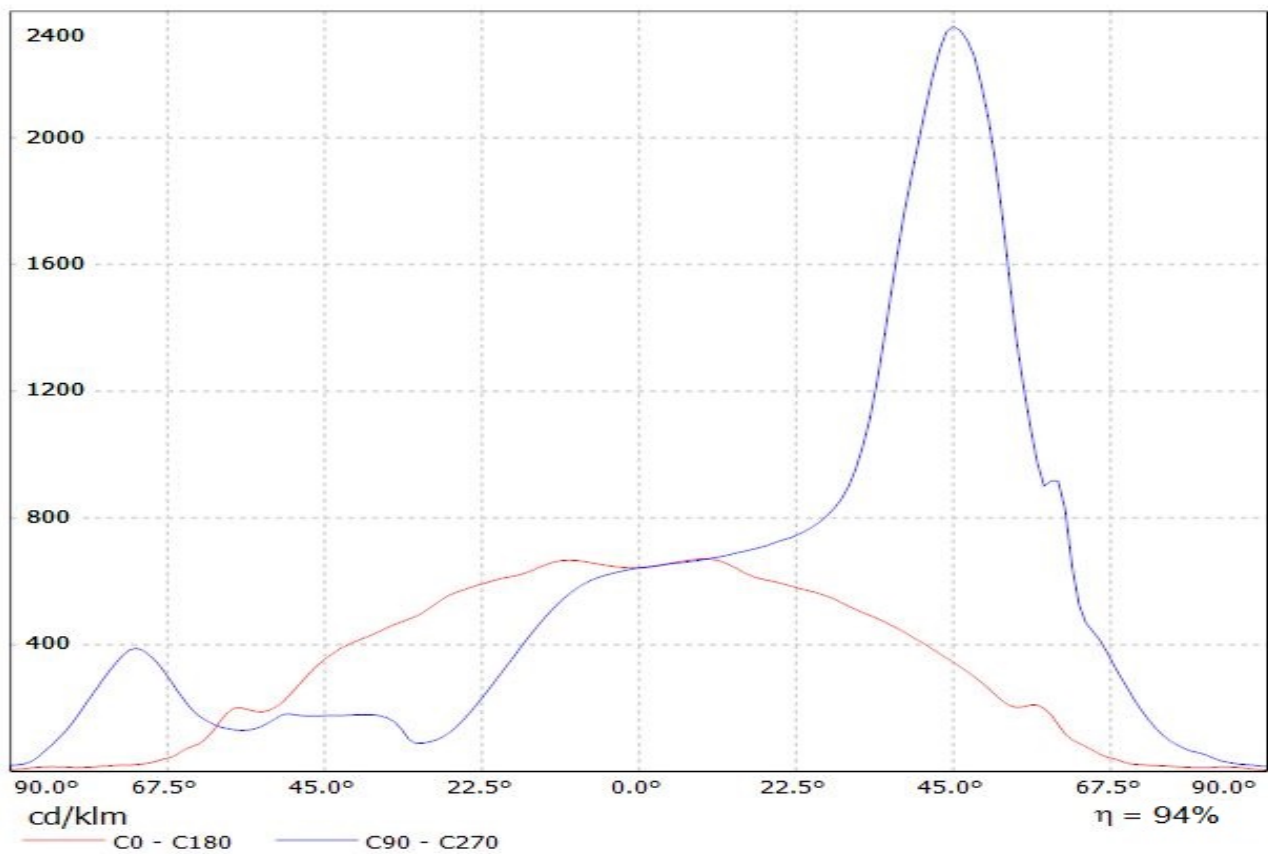

Luminaire: LEDiL Oy C13604_STRADA-2X2-FN_(XM-L) Eff: 94%
Lamps: 1 x Cree XM-L 355.205lm@250mA P=2.83062W I=0.2499A

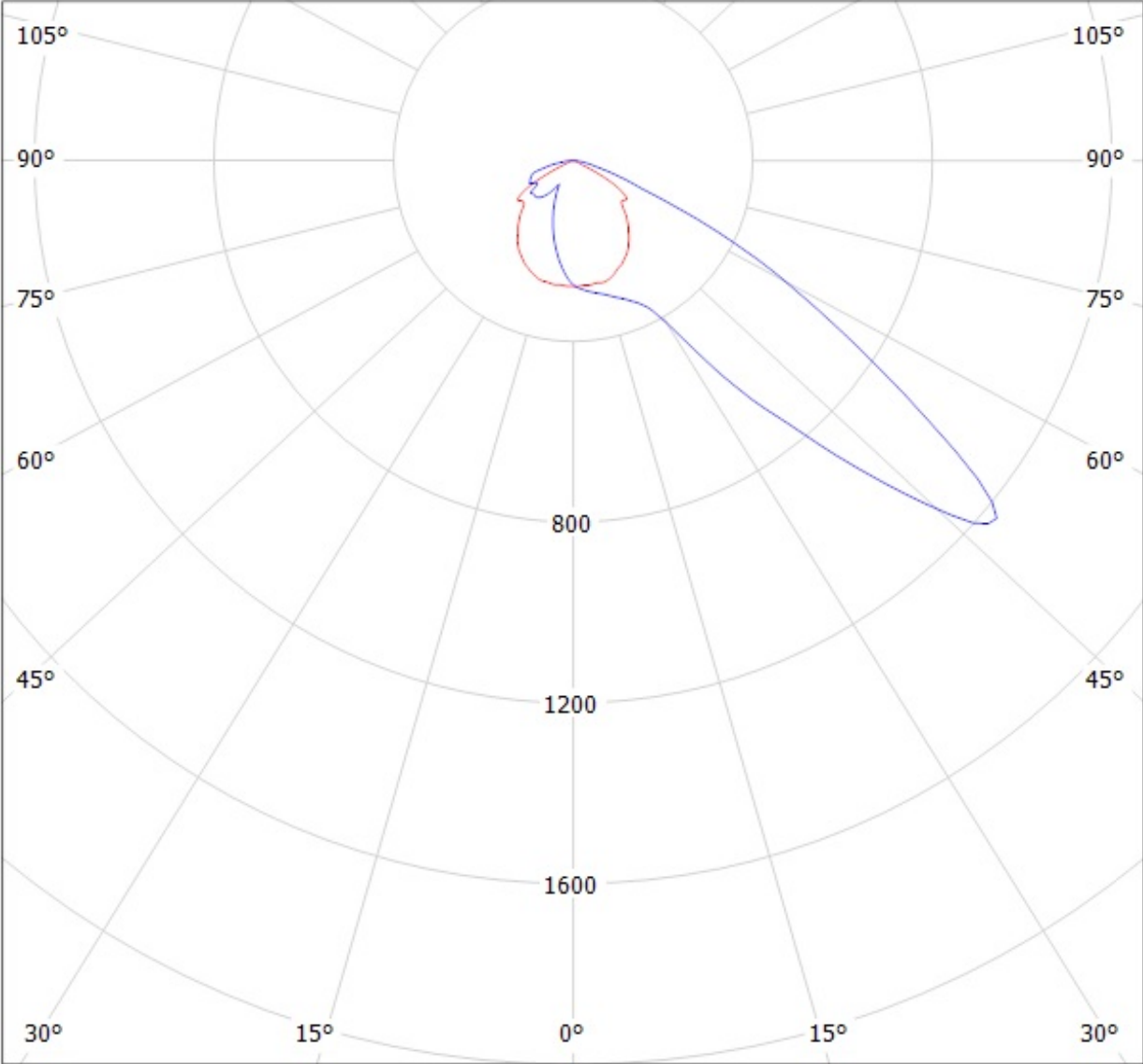

cd/klm
— C0 - C180 — C90 - C270

Luminaire: Ledil Oy C13604_STRADA-2X2-FN_(XT-E)_SIMULATED
Lamps: 1 x Cree XT-E

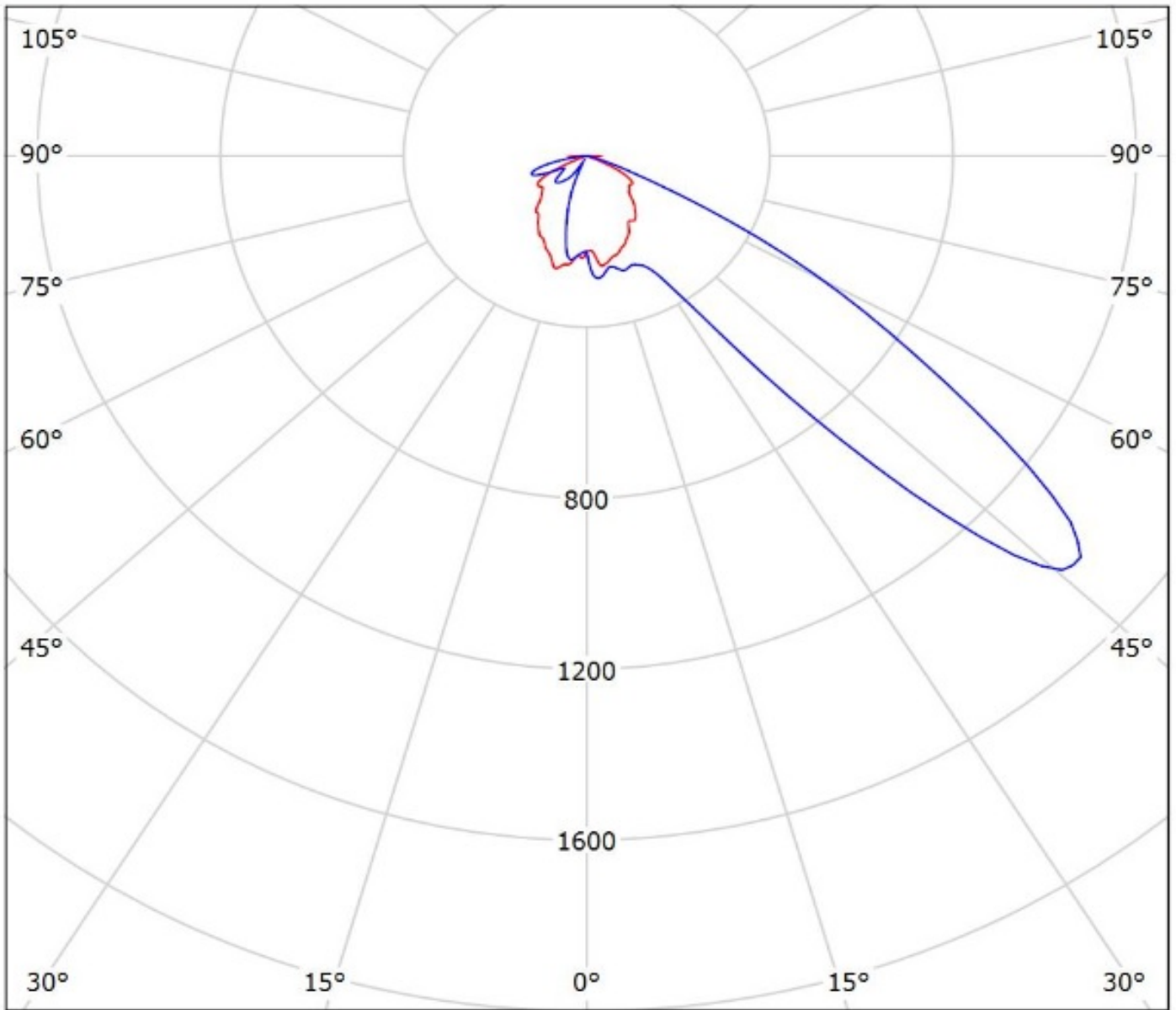

cd/klm

— C0 - C180 — C90 - C270

$\eta = 91\%$

Luminaire: LEDil Oy C13604_STRADA-2X2-FN_(XM-L2) Efficiency=94%

Lamps: 1 x Cree XM-L2 (XMLBWT-0-7B4-T30-0L-0001) 356lm @ 250mA CCT=3200K P=2.8W I=250mA

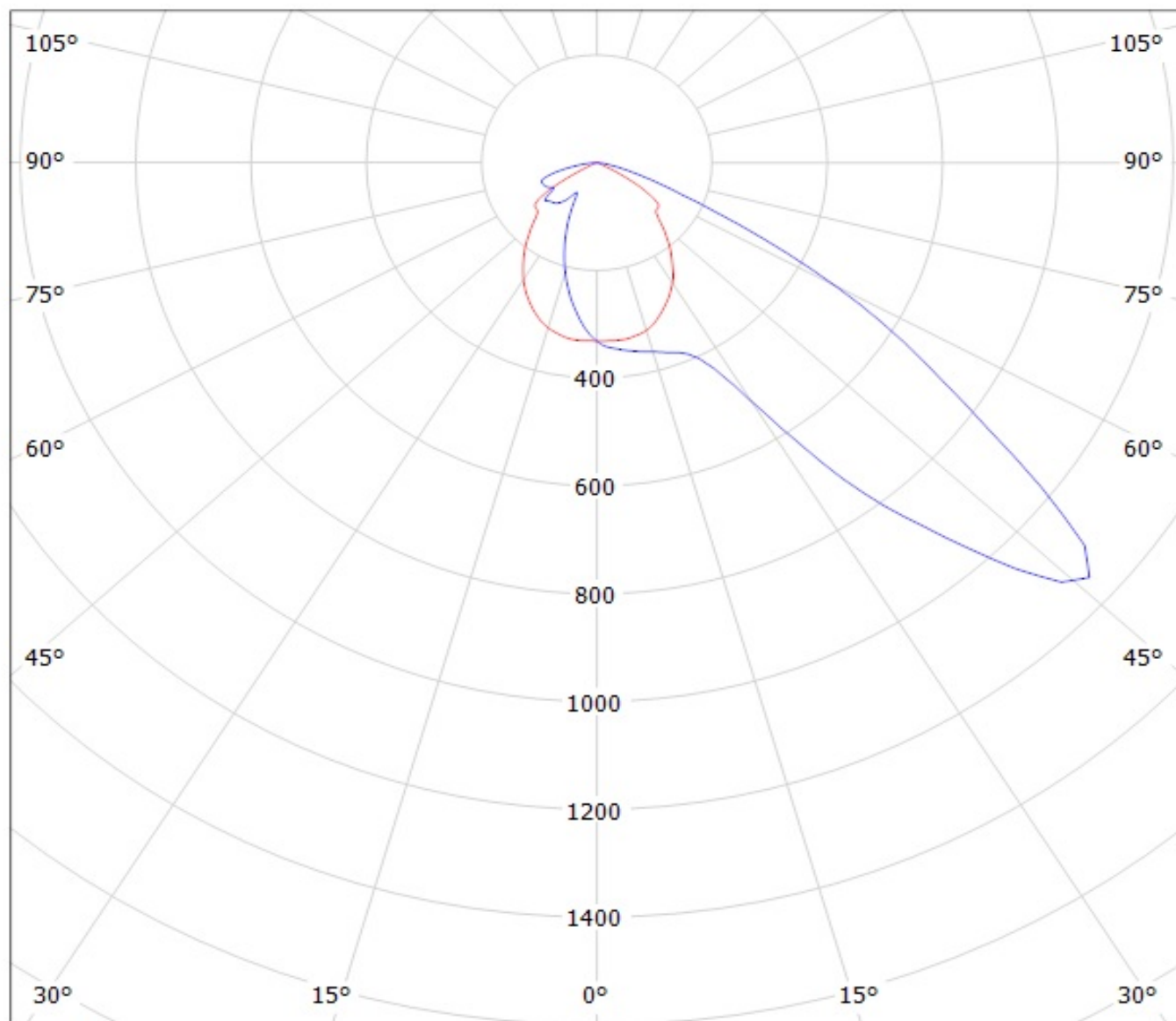

cd/klm

— C0 - C180

— C90 - C270

Luminaire: LEDiL Oy C13604_STRADA-2x2-FN_(XP-L)

Lamps: 1 x CREE_XP-L_2x2_(XPLAWT-0-1B0-V40-00-0001)_512.69lm@250mA_CCT=7600K_P=2.79963W_I=249.9mA

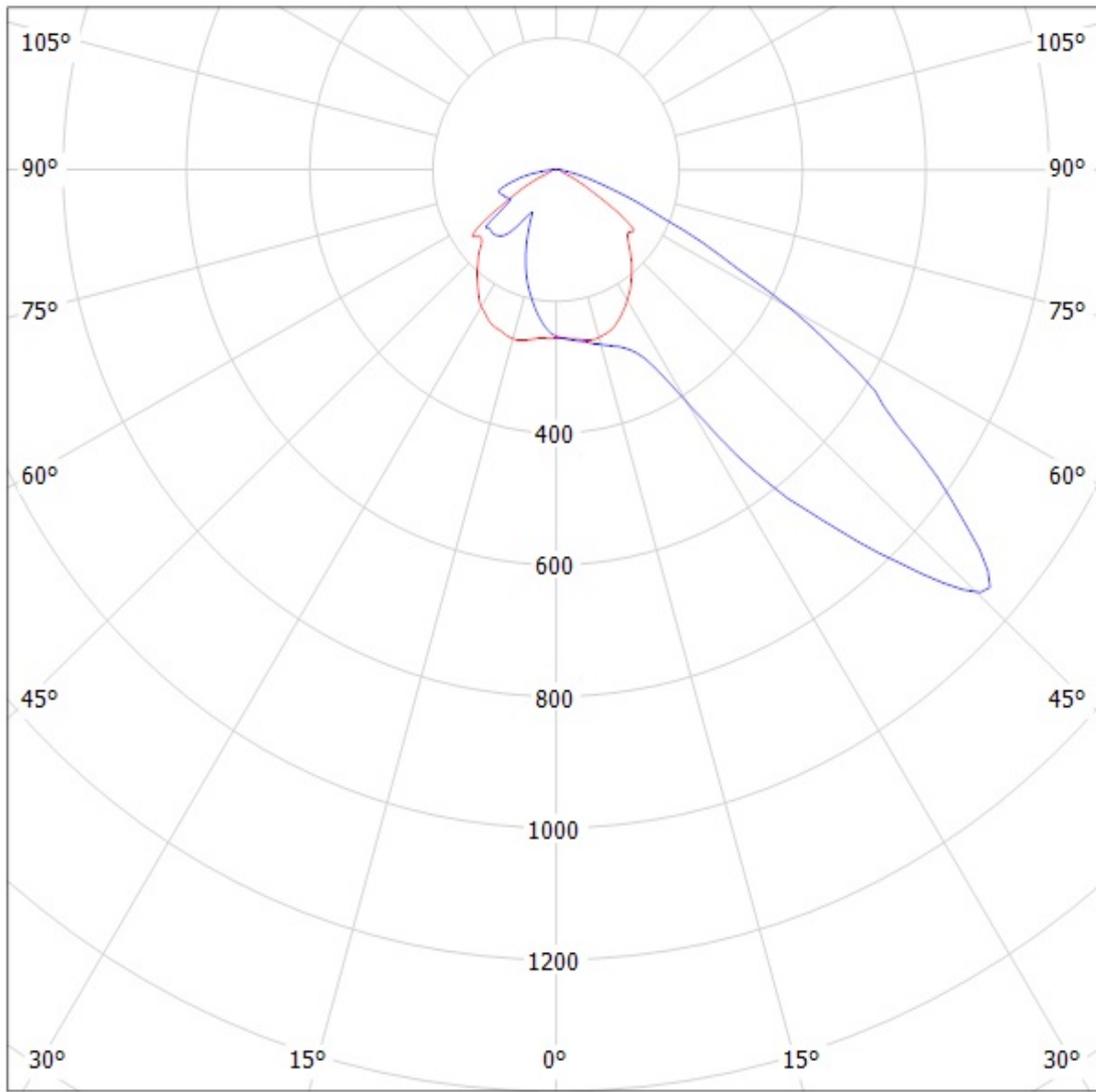

cd/klm

— C0 - C180 — C90 - C270

$\eta = 94\%$

Luminaire: LEDiL Oy C13604_STRADA-2X2-FN_(XP-L_HI)
Lamps: 1 x Cree_XP-L_HI_(2x2)_(XPLAWT-H-5A3-U60-013-0001)
_455.077lm@250mA_P=2.84011W_I=0,2499A

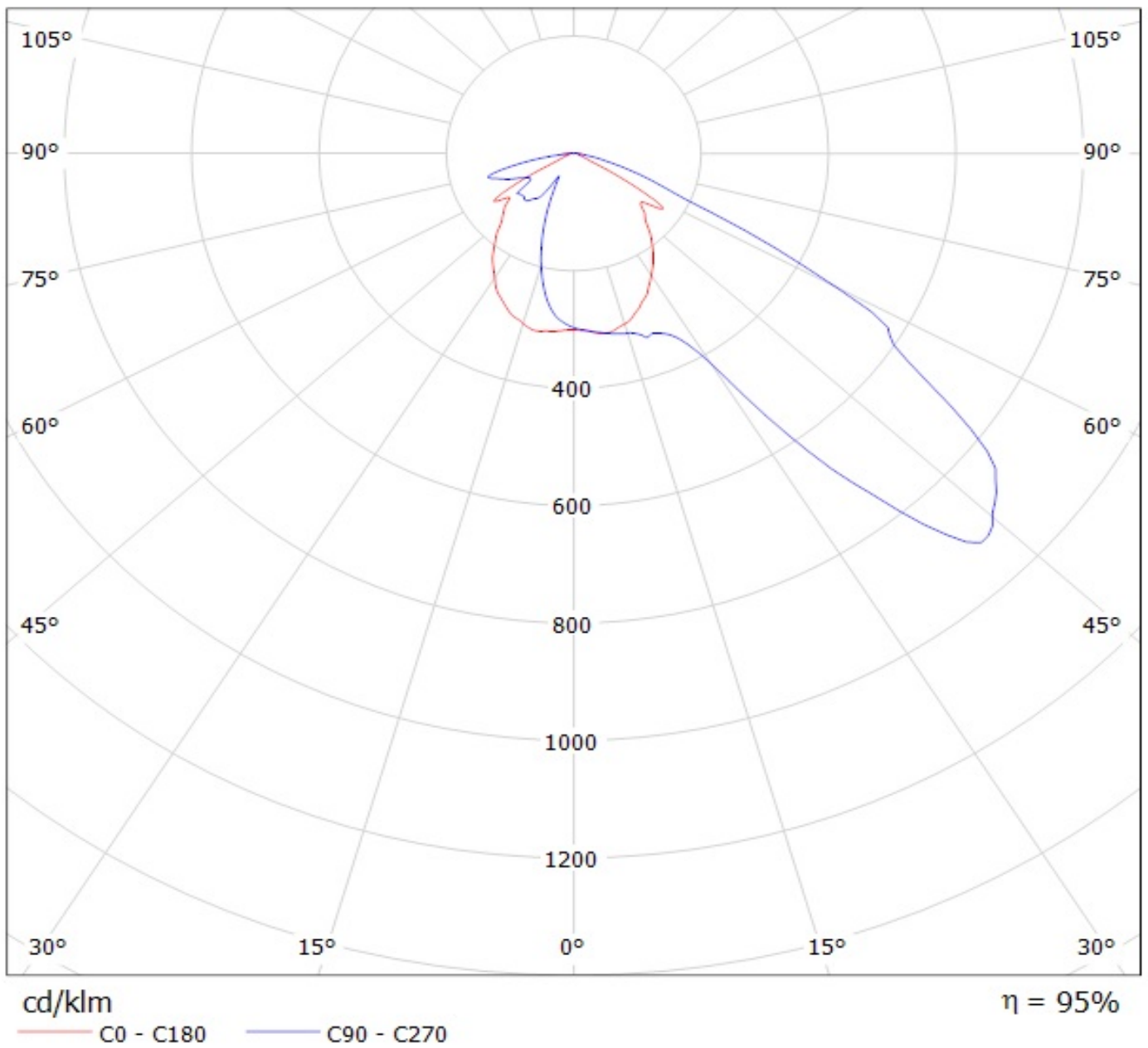

Luminaire: Ledil C13604_STRADA-2x2-FN_(XP-G3)

Lamps: 1 x Cree_XP-G3_2x2_(XPGDWT-B1-3C0-S4-0-01)_516.459lm@250mA_P=2.7885W_I=0.25A

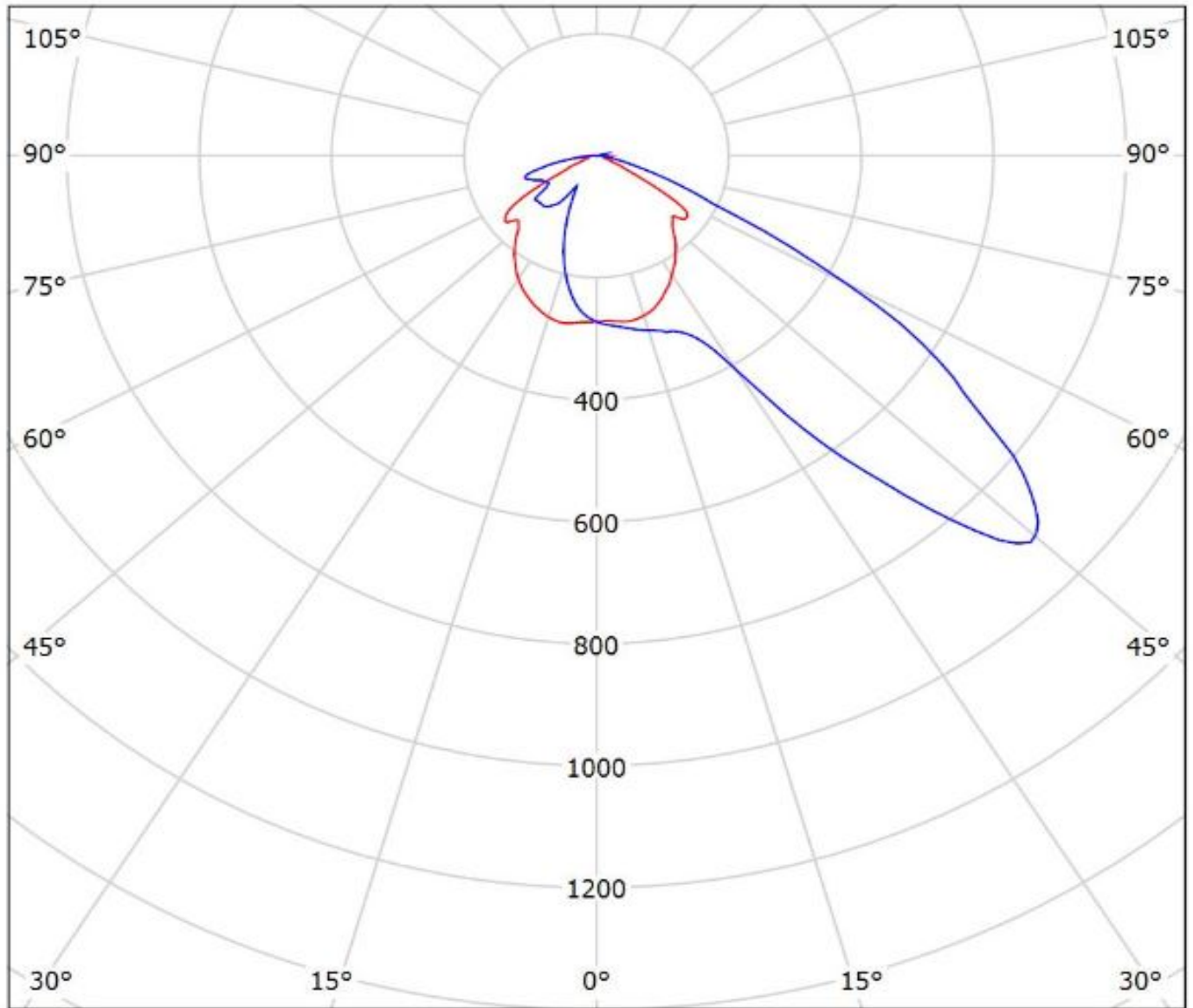

cd/klm

— C0 - C180 — C90 - C270

$\eta = 96\%$

Luminaire: Ledil C13604_STRADA-2X2-FN_(XP-L2)

Lamps: 1 x Cree_XP-L2_2x2_(XPLBWT-00-0000-000BV50E3)550.93lm@250mA_P=2.7815W_I=0.25A

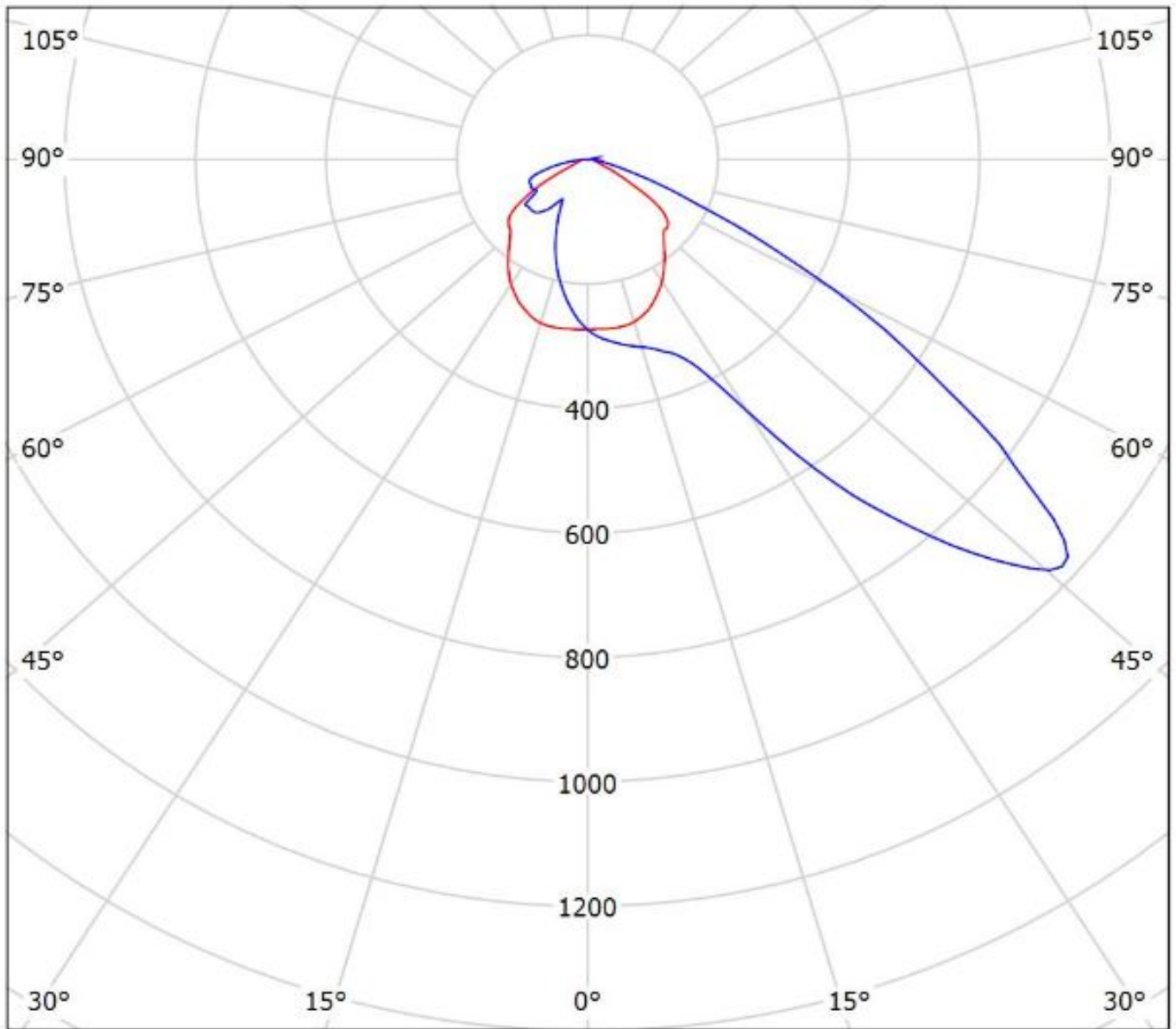

cd/klm

— C0 - C180

— C90 - C270

$\eta = 96\%$

Luminaire: Ledil C13604_STRADA-2X2-FN_(H35C1)

Lamps: 1 x LG_H35C1_2x2_477.216lm@250mA_P=2.87475W_I=0.250A

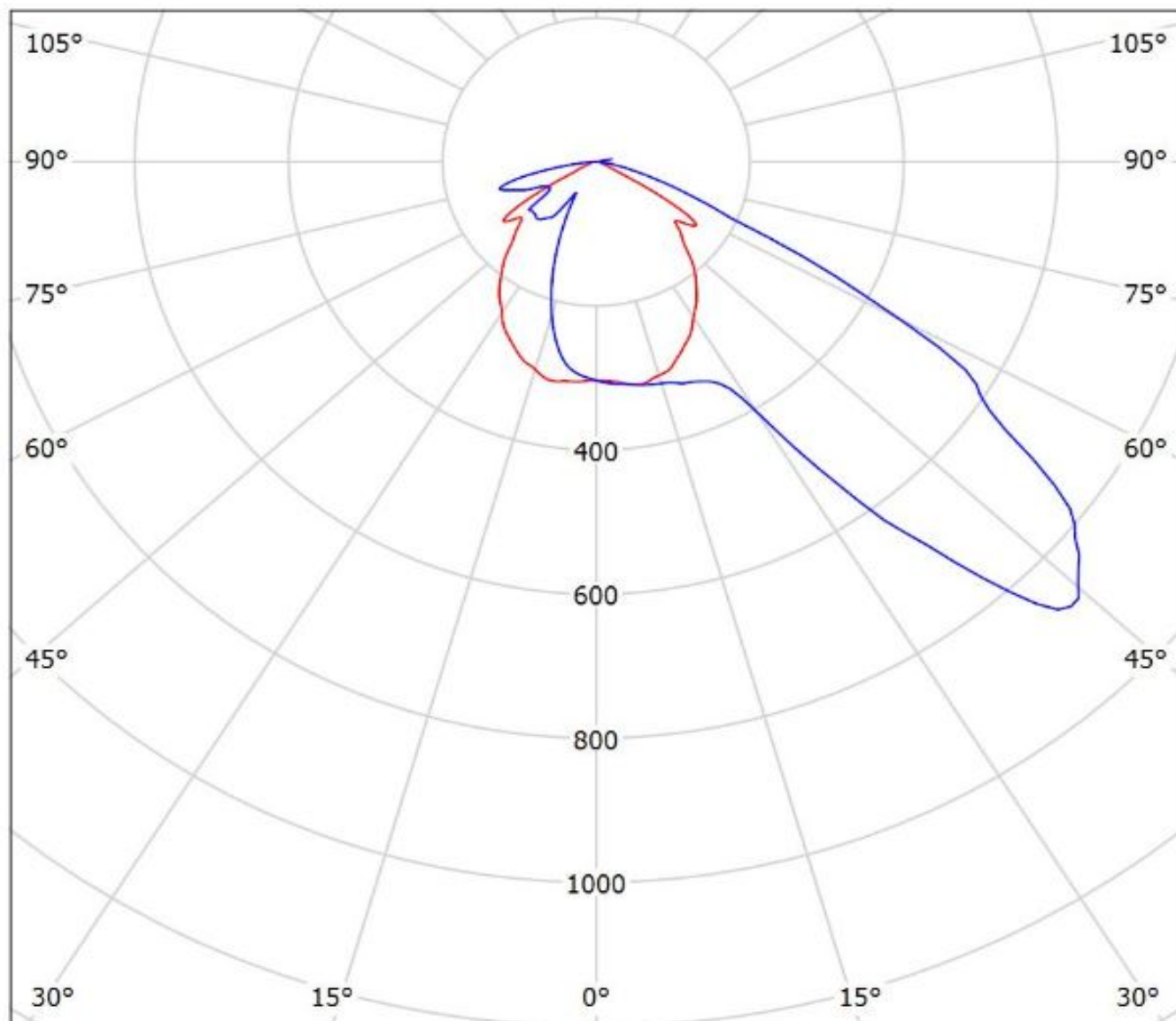

cd/klm

— C0 - C180 — C90 - C270

$\eta = 95\%$

Luminaire: LEDiL Oy C13604_STRADA-2x2-FN_(LUXEON_Q)

Lamps: 1 x LUXEON_Q_2x2_(LHQ-3080)_298.615lm@250mA_P=2.86995W_I=249.8mA

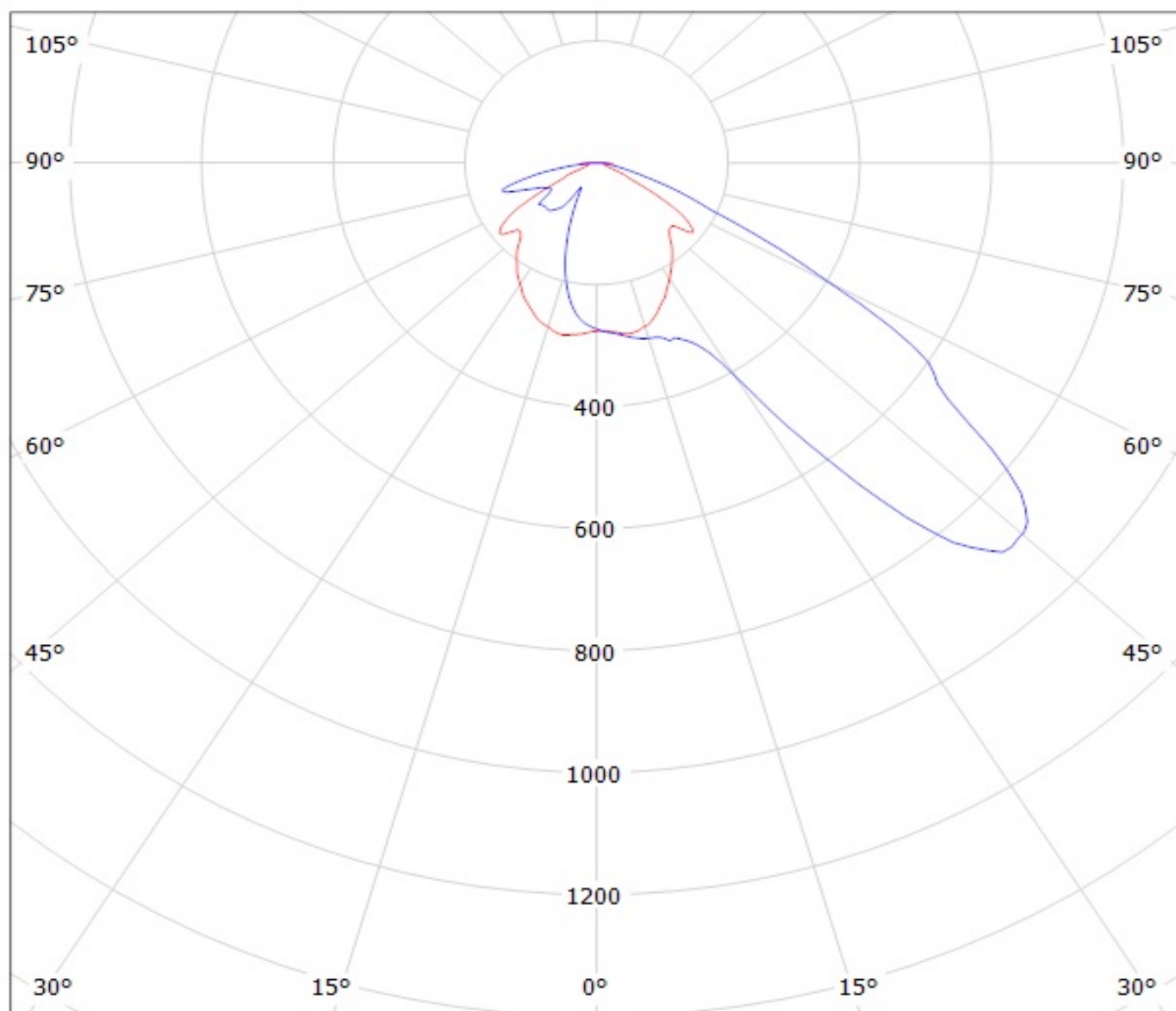

cd/klm

— C0 - C180

— C90 - C270

Luminaire: LEDiL Oy C13604_STRADA-2X2-FN_(Luxeon_T) Eff 94%
Lamps: 1 x Luxeon_T_2x2_(LXH8-FW30-3)_289lm@250mA_CCT=3000K_P=2.8W_I=249.9mA

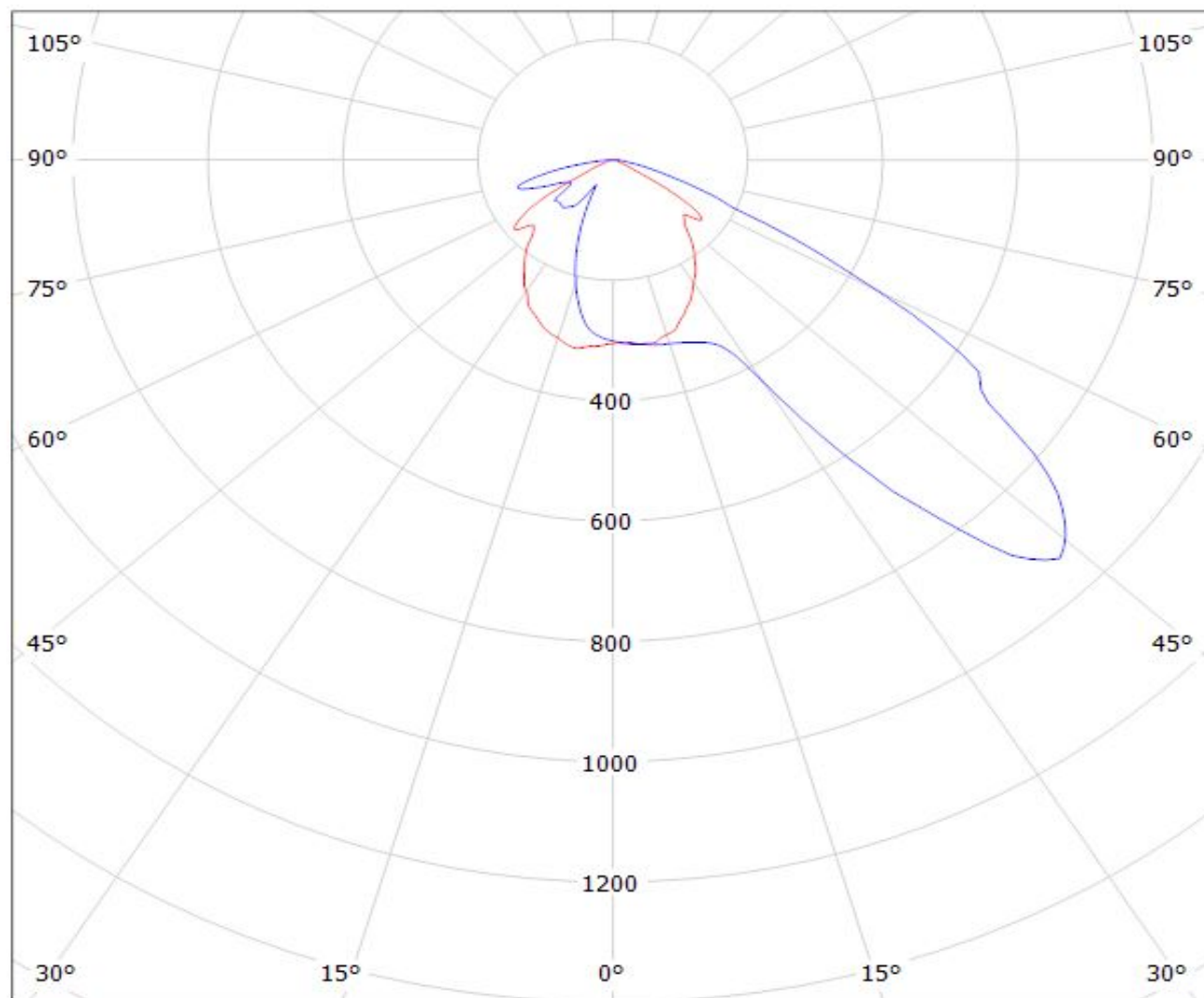

cd/klm

— C0 - C180

— C90 - C270

$\eta = 95\%$

Luminaire: LEDiL Oy C13604_STRADA-2X2-FN_(Luxeon_TX)
Lamps: 1 x Luxeon_TX_321.463lm@250mA_P=2.79513W_I=249.9mA

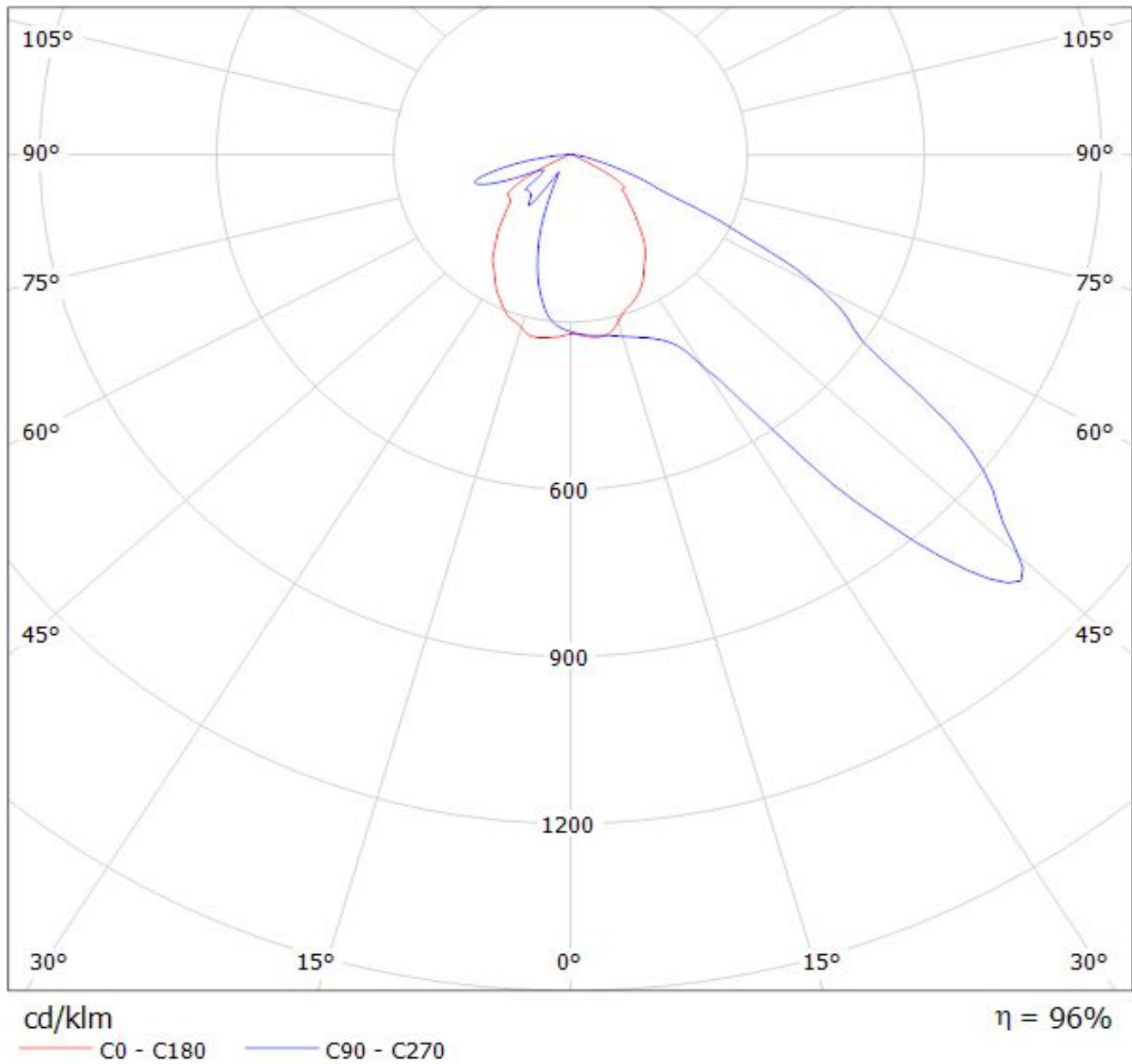

Luminaire: Ledil C13604_STRADA-2X2-FN (Luxeon_MZ)

Lamps: 1 x Philips_Lumileds_Luxeon_MZ_(LMZ7-QW57)_(2x2)_427.268lm@250mA_P=2.734W_I=0.2500A

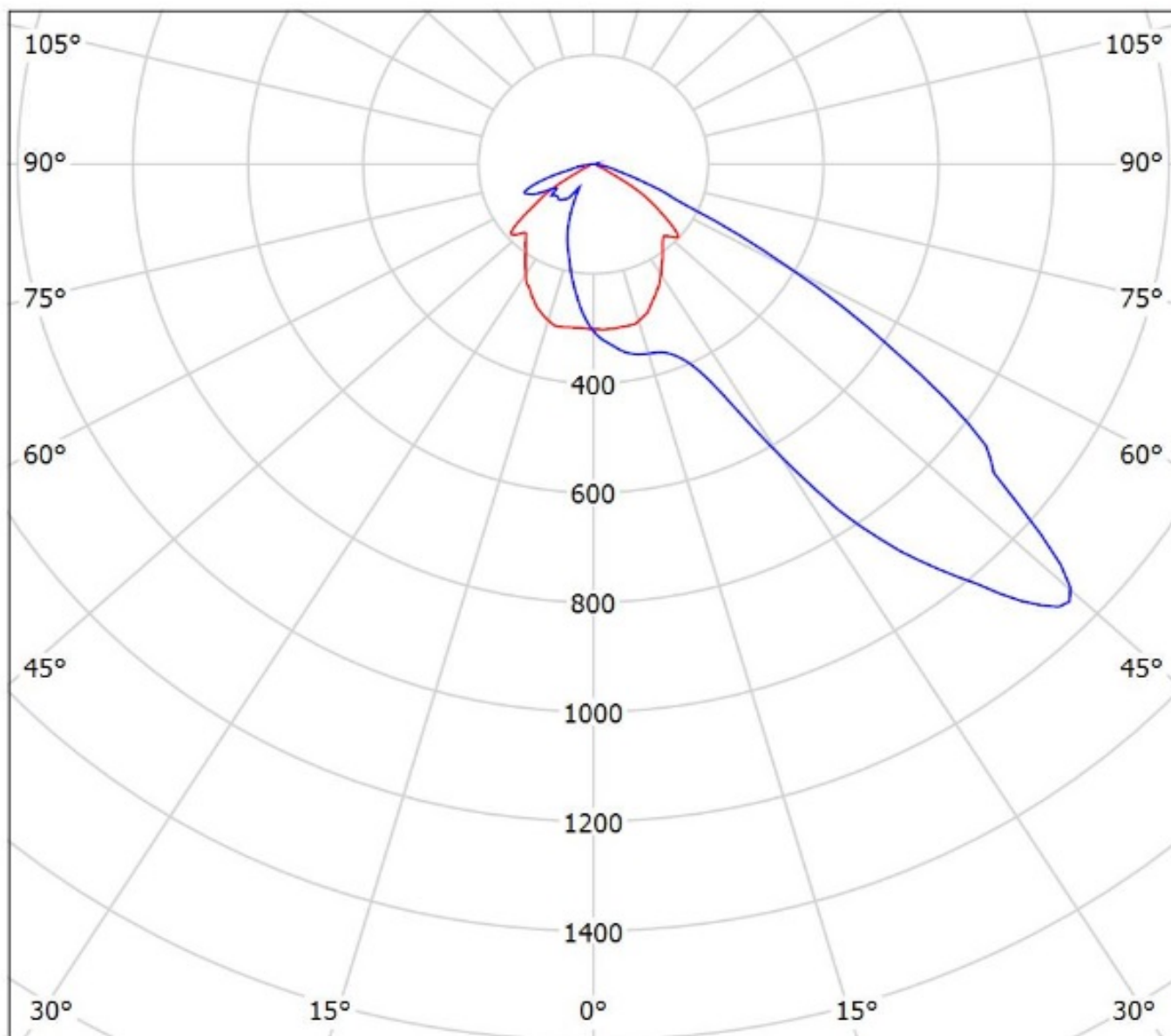

cd/klm

— C0 - C180 — C90 - C270

$\eta = 96\%$

Luminaire: Ledil C13604-Strada-2x2-FN_(NVSL219CE)

Lamps: 1 x Nichia_NVSL219CE_496.405lm@250mA_CCT=4000K_P=2.8465W_I=0.25A

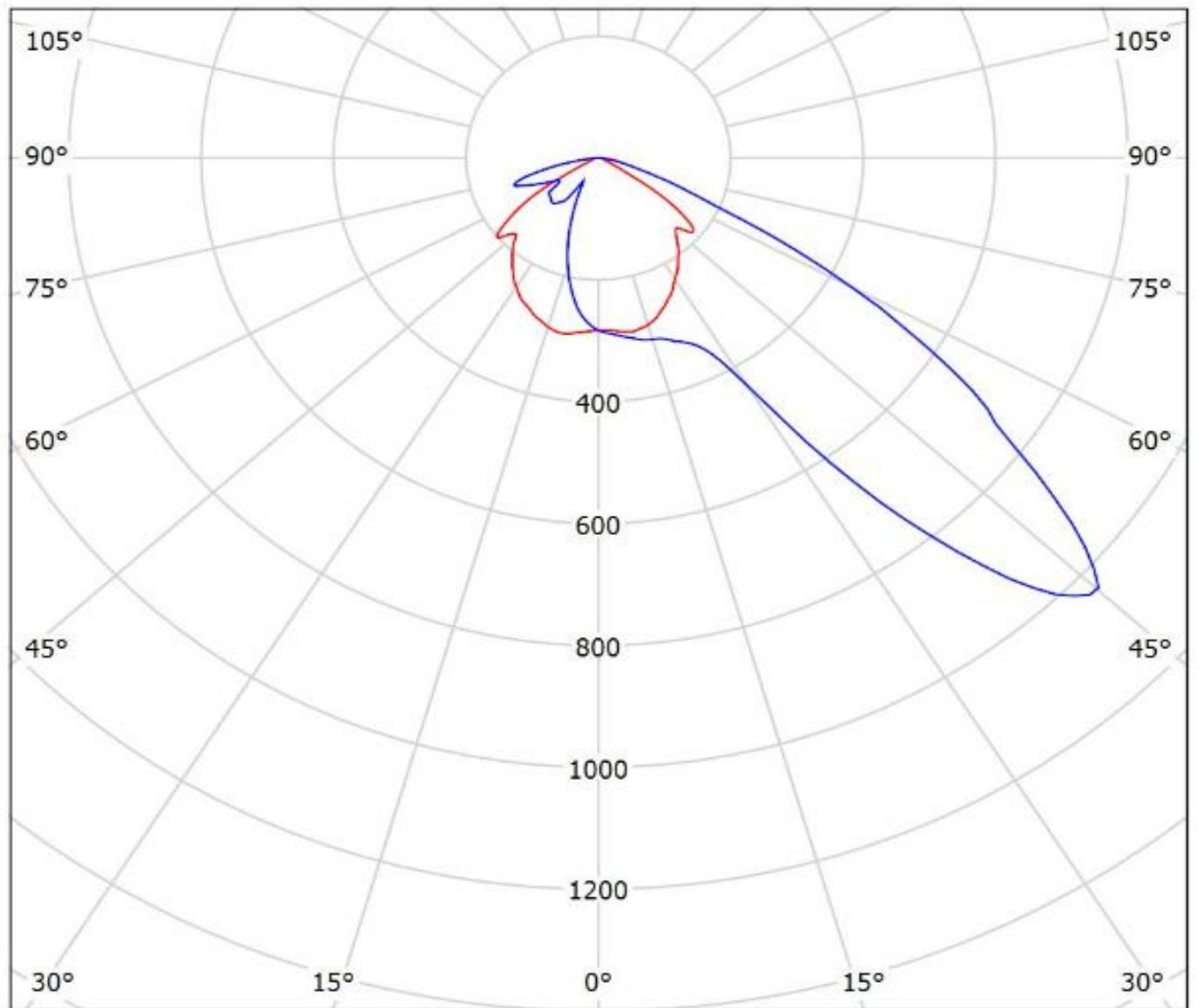

cd/klm

— C0 - C180 — C90 - C270

$\eta = 95\%$

Luminaire: LEDiL Oy C13604_STRADA-2X2-FN_(E21A)
Lamps: 1 x Nichia_E21A_2X2_454.11lm@250mA_P=2.81W_I=0.250A

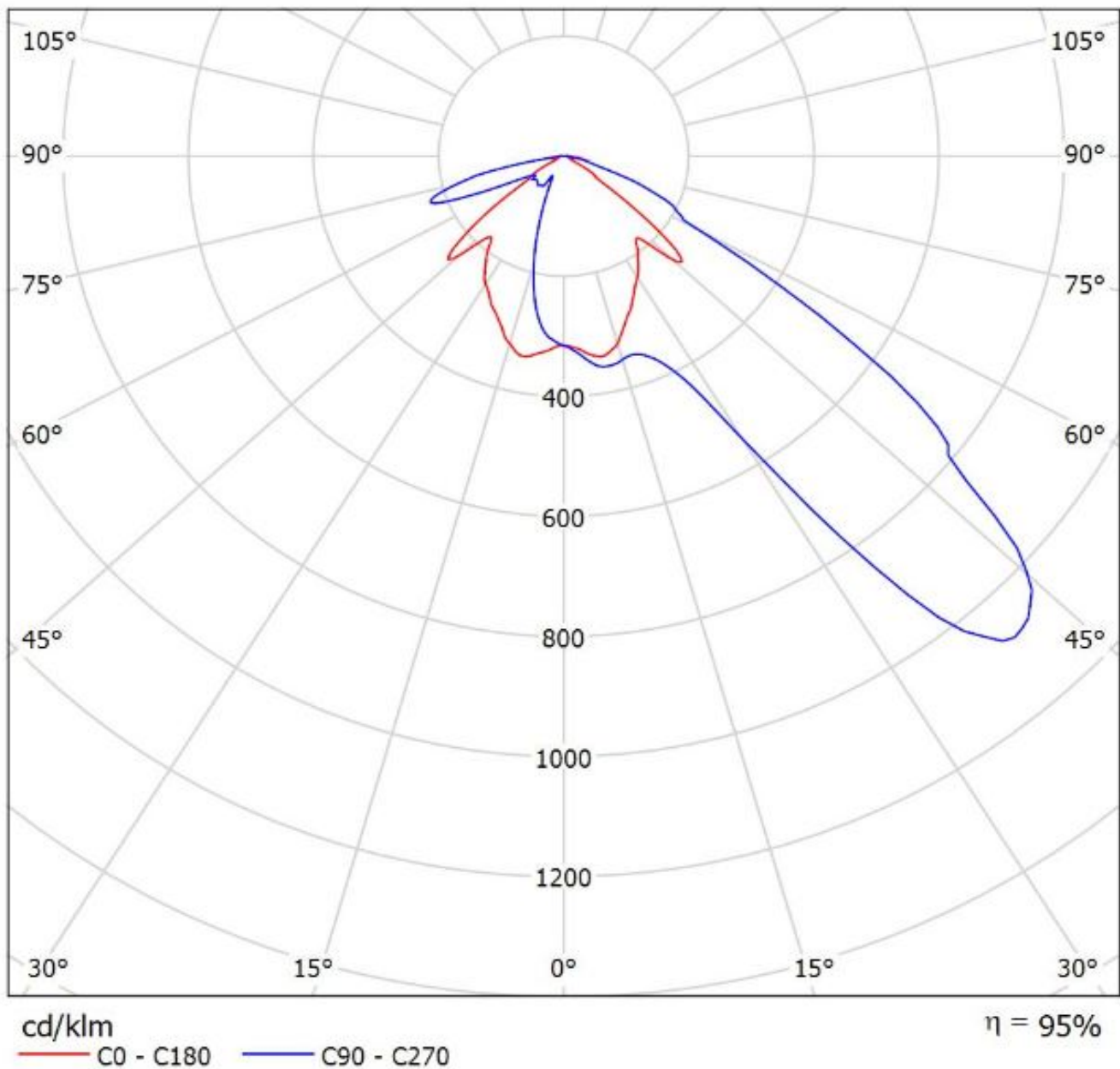

Luminaire: LEDiL Oy C13604_STRADA-2X2-FN_(NVSW319AE)
Lamps: 1 x Nichia_NVSW319AE_499.093lm@250mA_P=2.79052W_I=0.25A

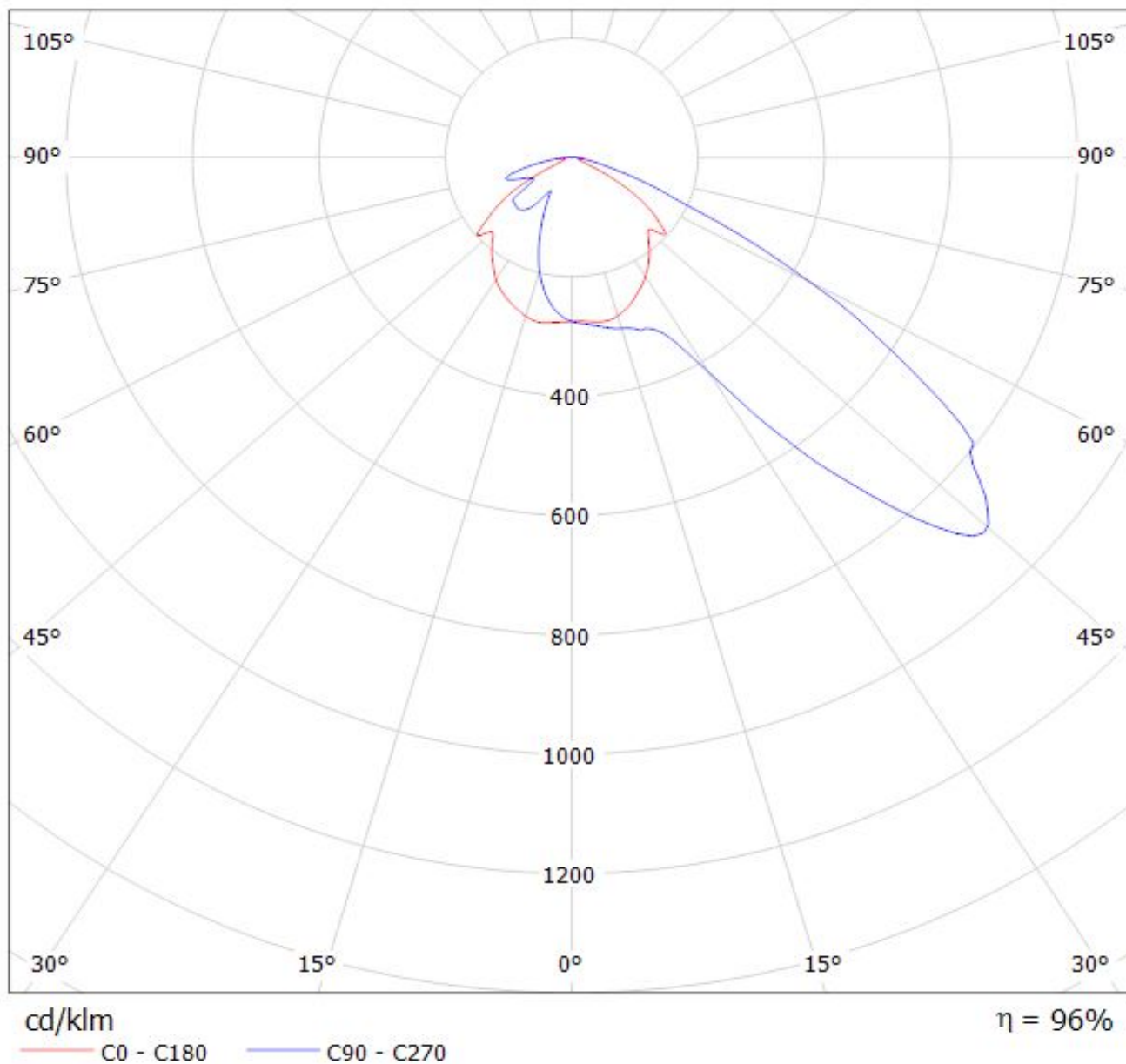

Luminaire: Ledil Oy C13604_STRADA-2X2-FN_(NWSx229A)_SIMULATED

Lamps: 1 x Nichia NWSW229A

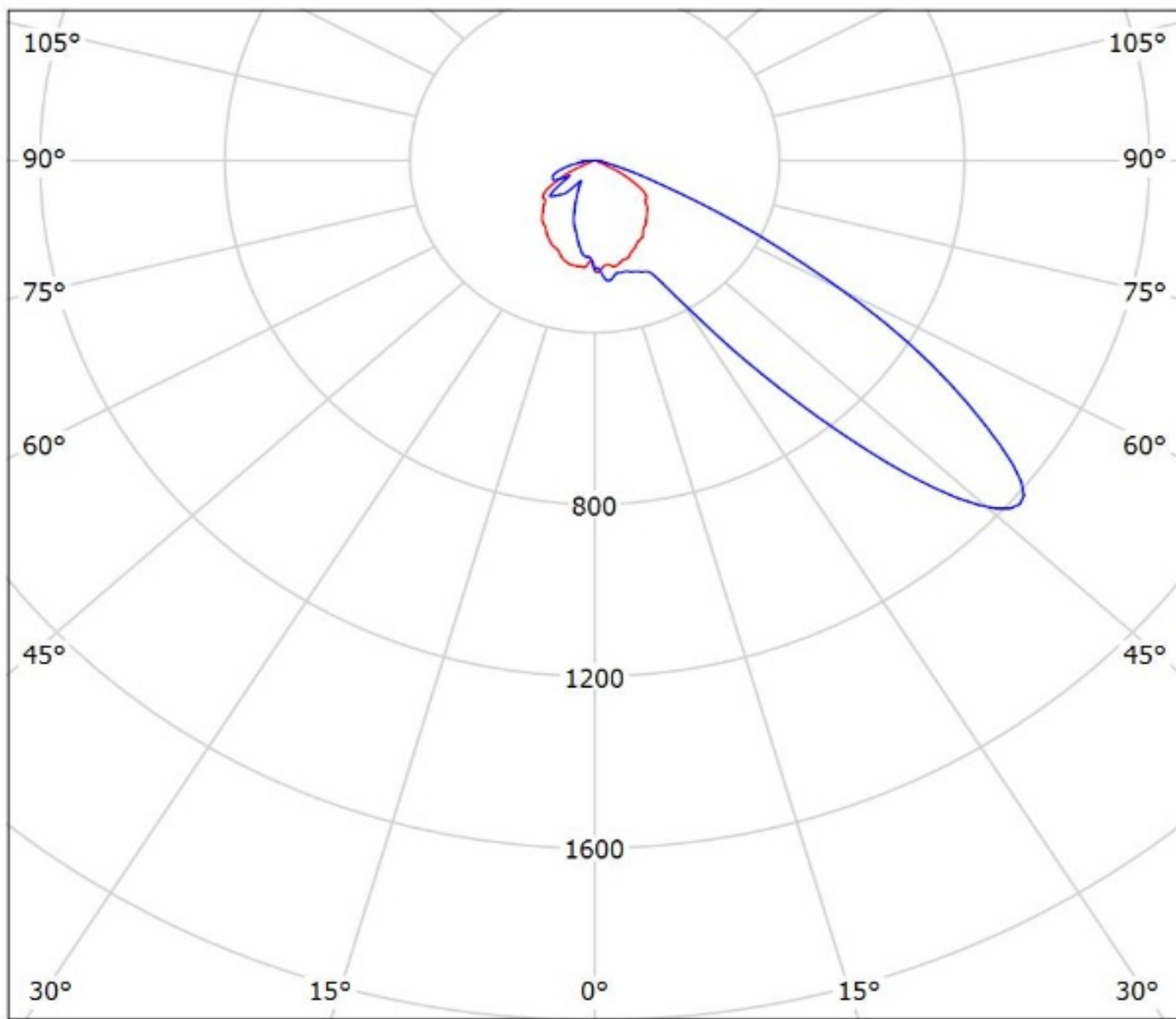

cd/klm

— C0 - C180 — C90 - C270

$\eta = 93\%$

Ledil C13604_STRADA-2X2-FN_(SQ-PC) / LDC (Polar)

Luminaire: Ledil C13604_STRADA-2X2-FN_(SQ-PC)
Lamps: 1 x Osram_Oslon_Square-PC_2x2_(GW_CSSRM1.PC)
_423.267lm@250mA_CCT=5201K_P=2.86W_I=0.25A

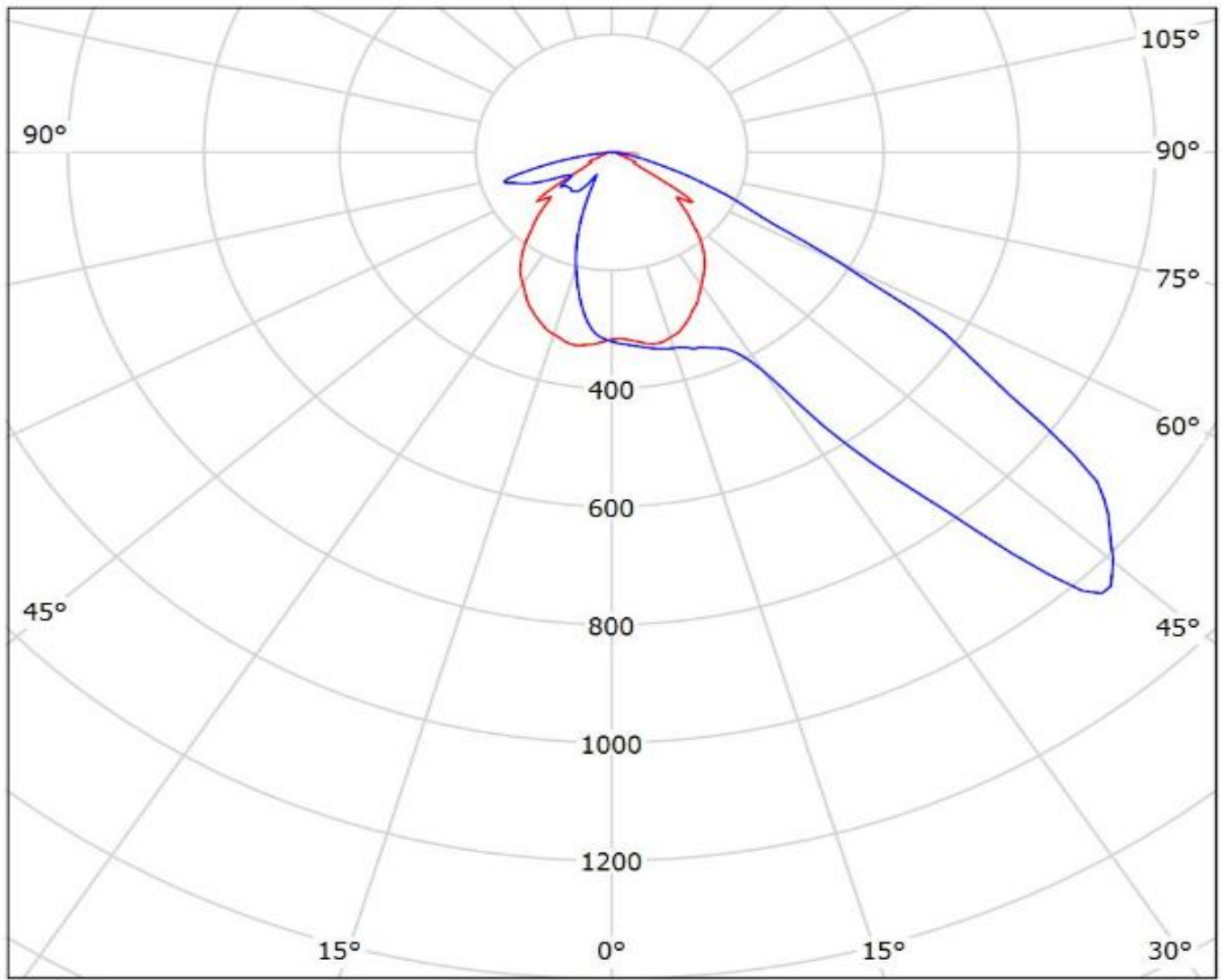

cd/klm

— C0 - C180 — C90 - C270

$\eta = 96\%$

Luminaire: LEDiL Oy
Lamps: 1 x C13604_Strada-2x2-FN_(SQ_Gen3)

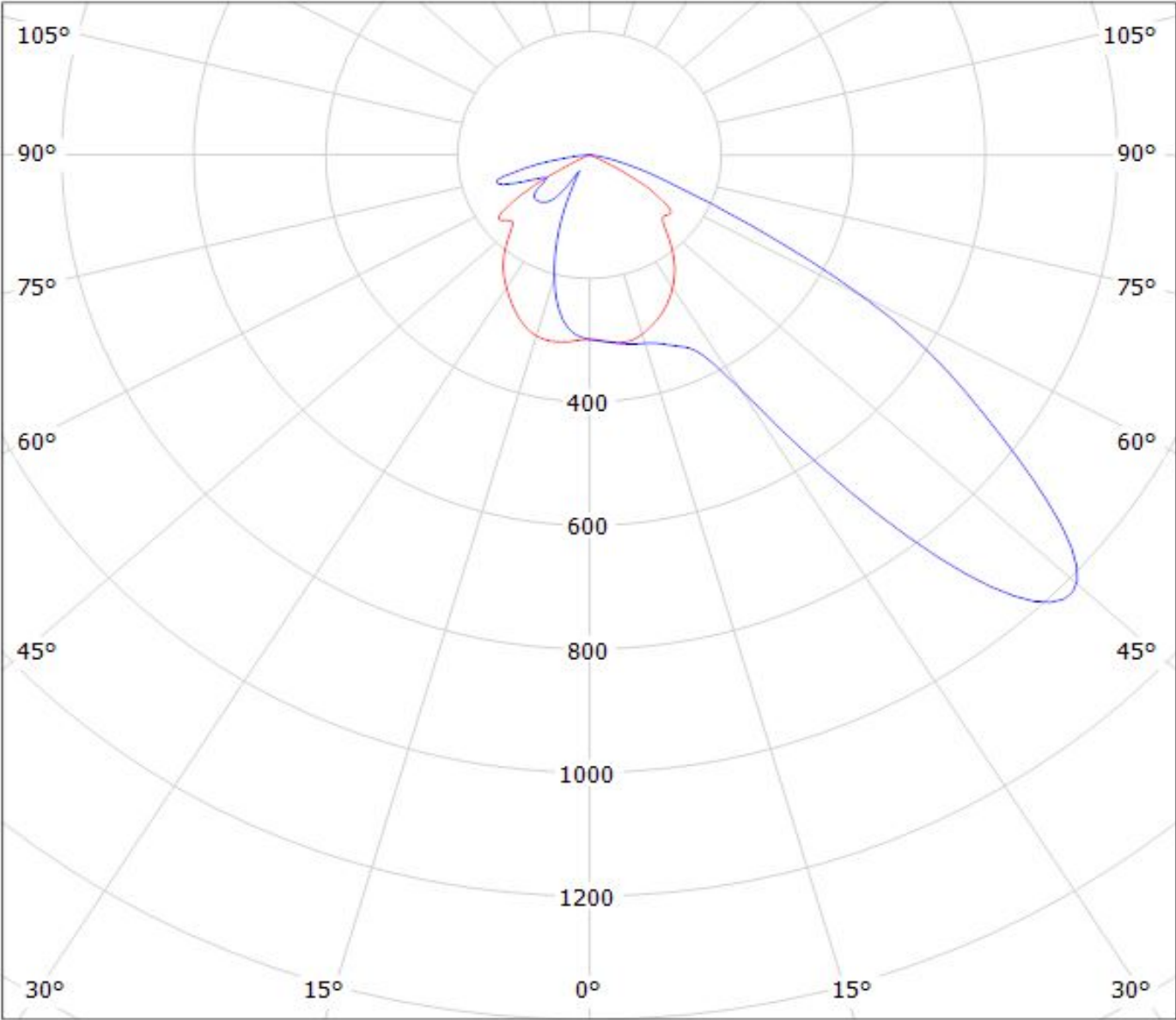

cd/klm

$\eta = 94\%$

— C0 - C180 — C90 - C270

Luminaire: Ledil Oy C13604_STRADA-2X2-FN_(Duris_P8)_SIMULATED
Lamps: 1 x Osram Duris P8 (GW PUSRA1.PM)

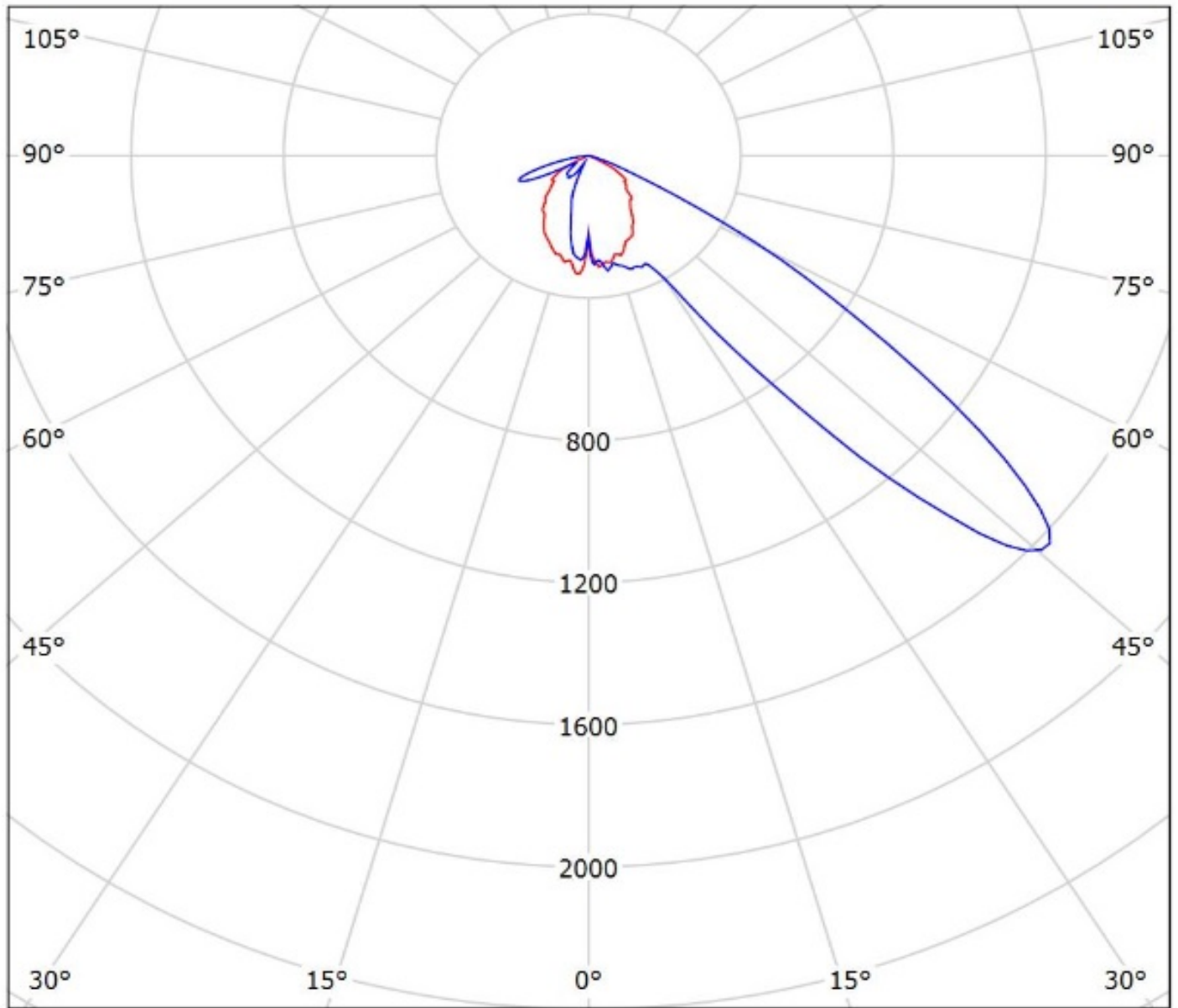

cd/klm

— C0 - C180 — C90 - C270

$\eta = 96\%$

Luminaire: Ledil C13604_STRADA-2X2-FN_(Fortimo_FastFlex_LED_board_2x8/740_DA_G3)
Lamps: 1 x Fortimo_FastFlex_LED_board_2x8/740_DA_G3_1828.23lm@250mA_P=11.667W_I=0.25A

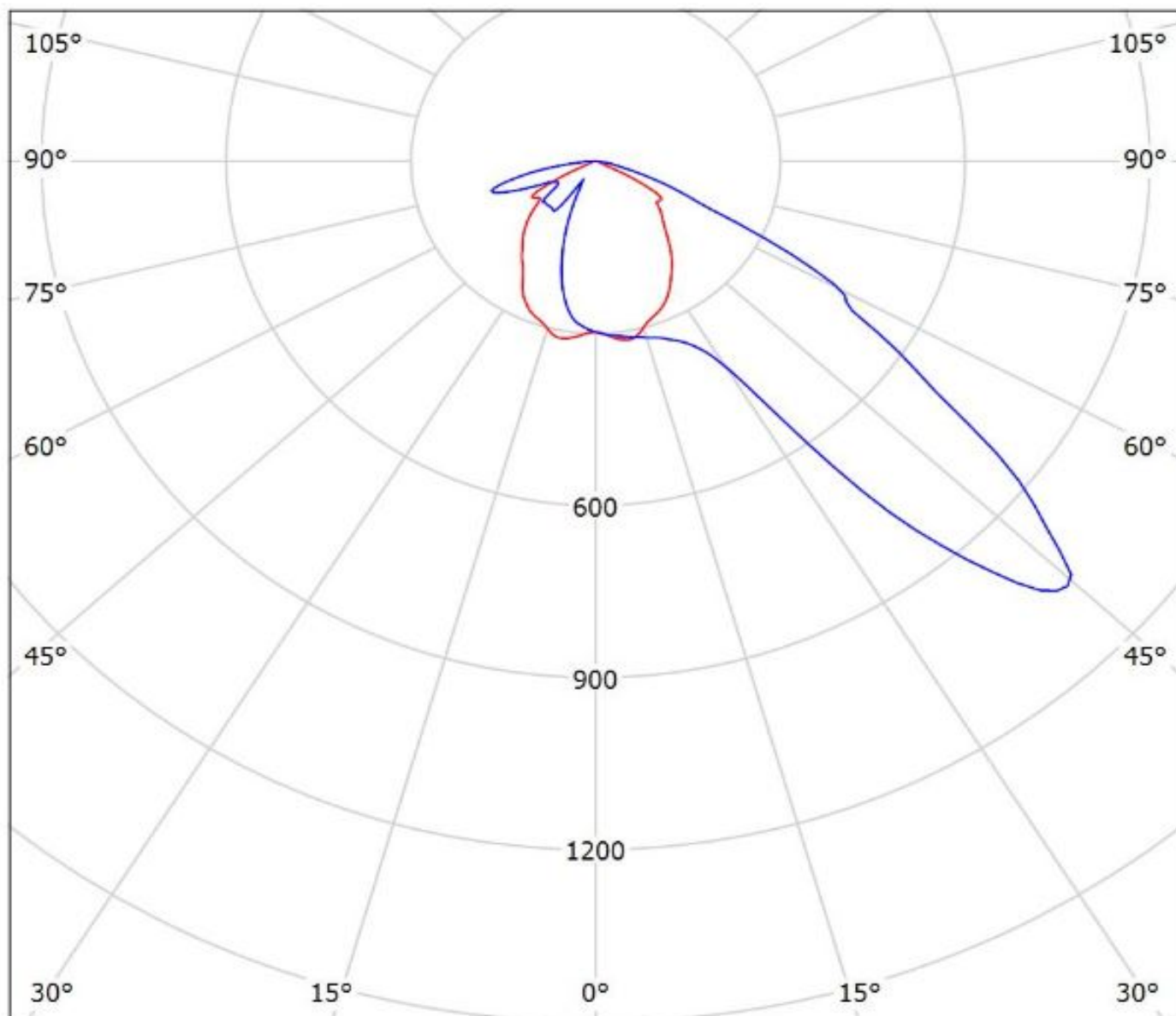

cd/klm

— C0 - C180 — C90 - C270

$\eta = 96\%$

Luminaire: Ledil C13604_STRADA-2X2-FN_(LH351B)

Lamps: 1 x Samsung_LH351B_2x2_444.178lm@250mA_P=2.8535W_I=0.25A

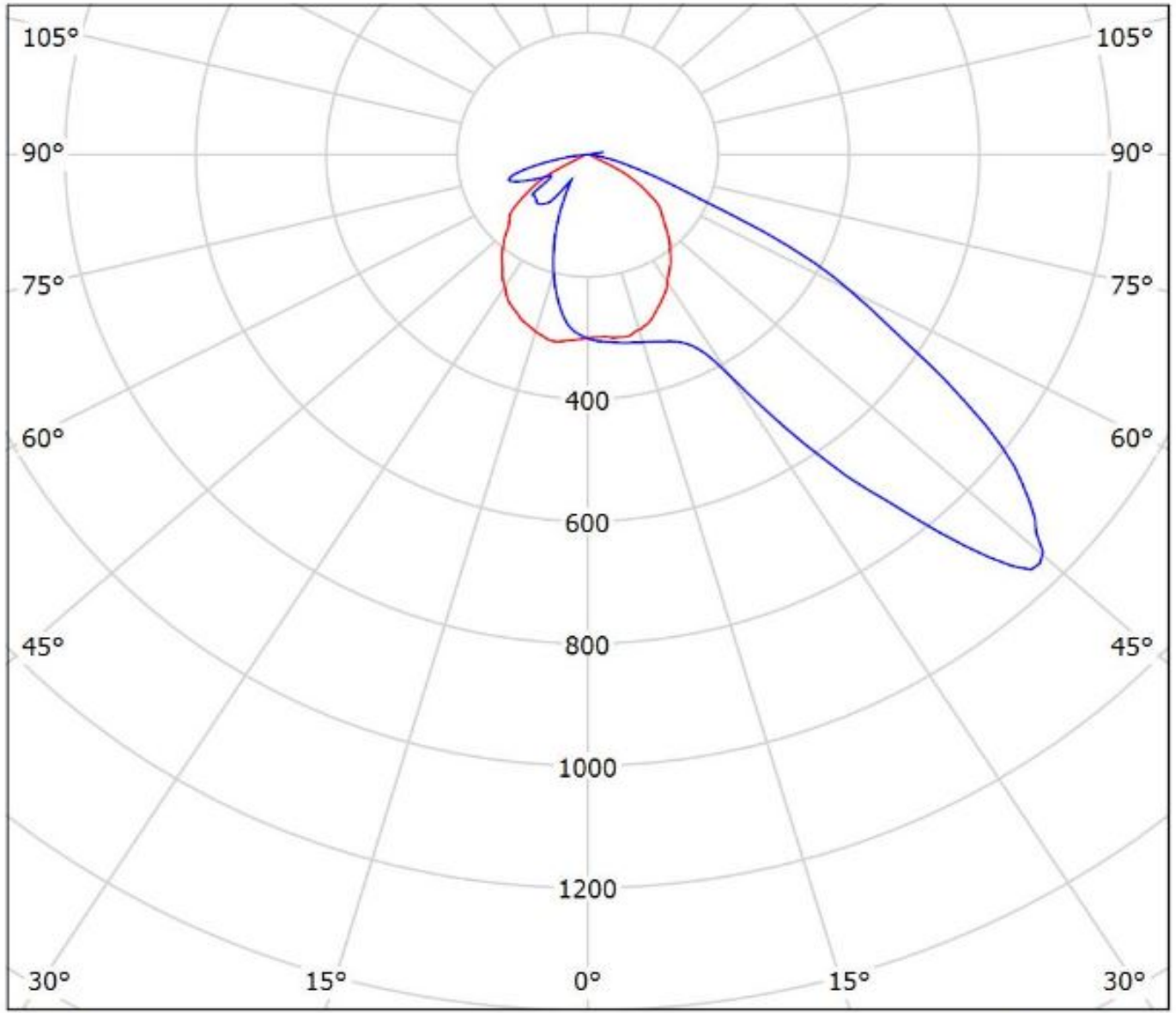

cd/klm

— C0 - C180 — C90 - C270

$\eta = 95\%$

Luminaire: Ledil C13604_STRADA-2X2-FN_(LH351B)_GS_Glass
Lamps: 1 x Samsung_LH351B_2x2_442.633lm@250mA_P=2.851W_I=0.25A

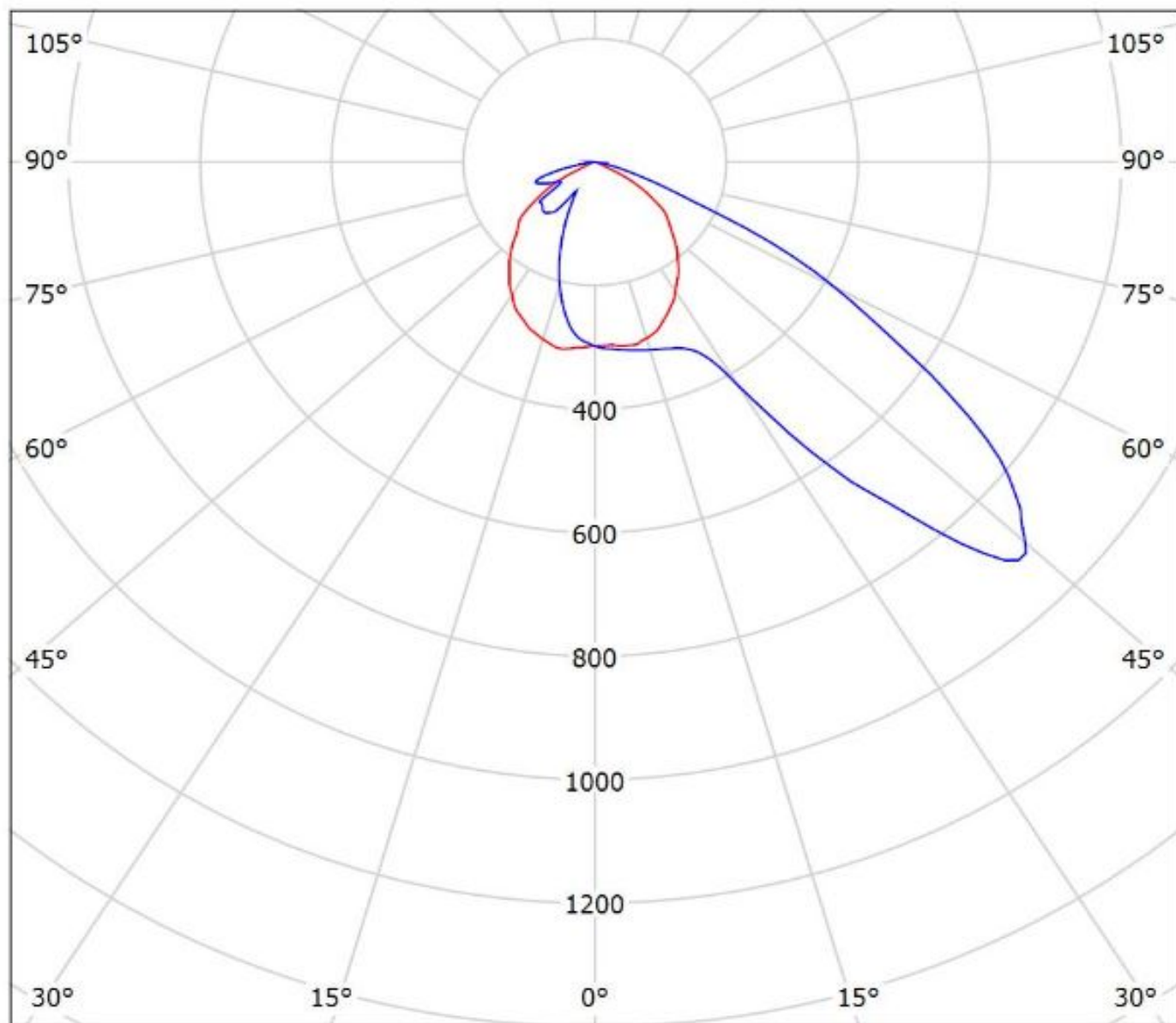

cd/klm

— C0 - C180 — C90 - C270

$\eta = 90\%$

Luminaire: LEDil Oy C13604_STRADA-2X2-FN_(Z5M1) Efficiency=94%
Lamps: 1 x Seoul Z5M1 (SZ5-M1-WN-C8) 379lm @ 250mA CCT=4600K P=2.9W I=250mA

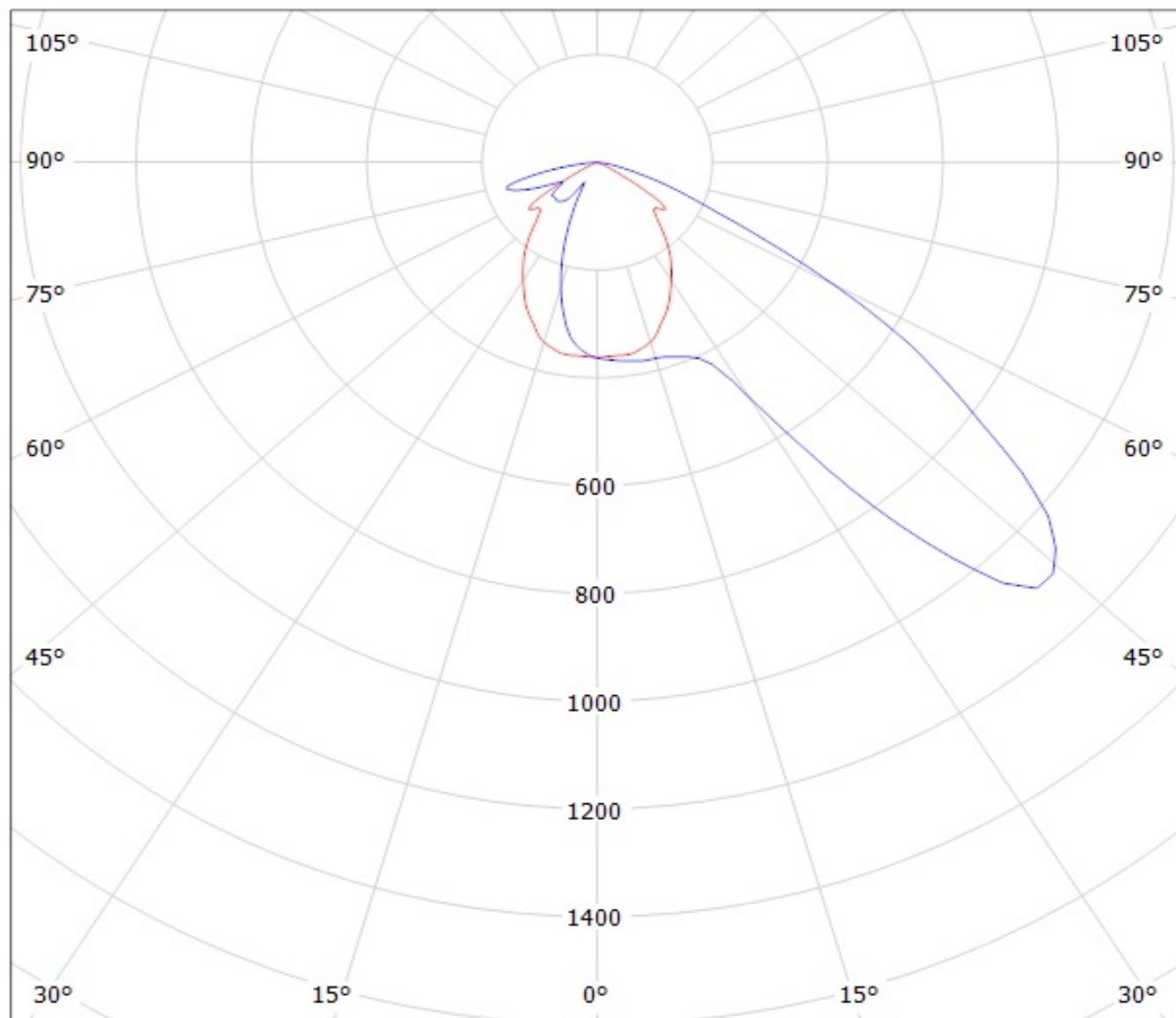

cd/klm

— C0 - C180

— C90 - C270

Ledil C13604_STRADA-2X2-FN_(TL1L3) / LDC (Polar)

Luminaire: Ledil C13604_STRADA-2X2-FN_(TL1L3)

Lamps: 1 x Toshiba_TL1L3_2x2_(TL1L3-NW1.L)_387.773lm@250mA_CCT=5000K_P=2.829W_I=0.25A

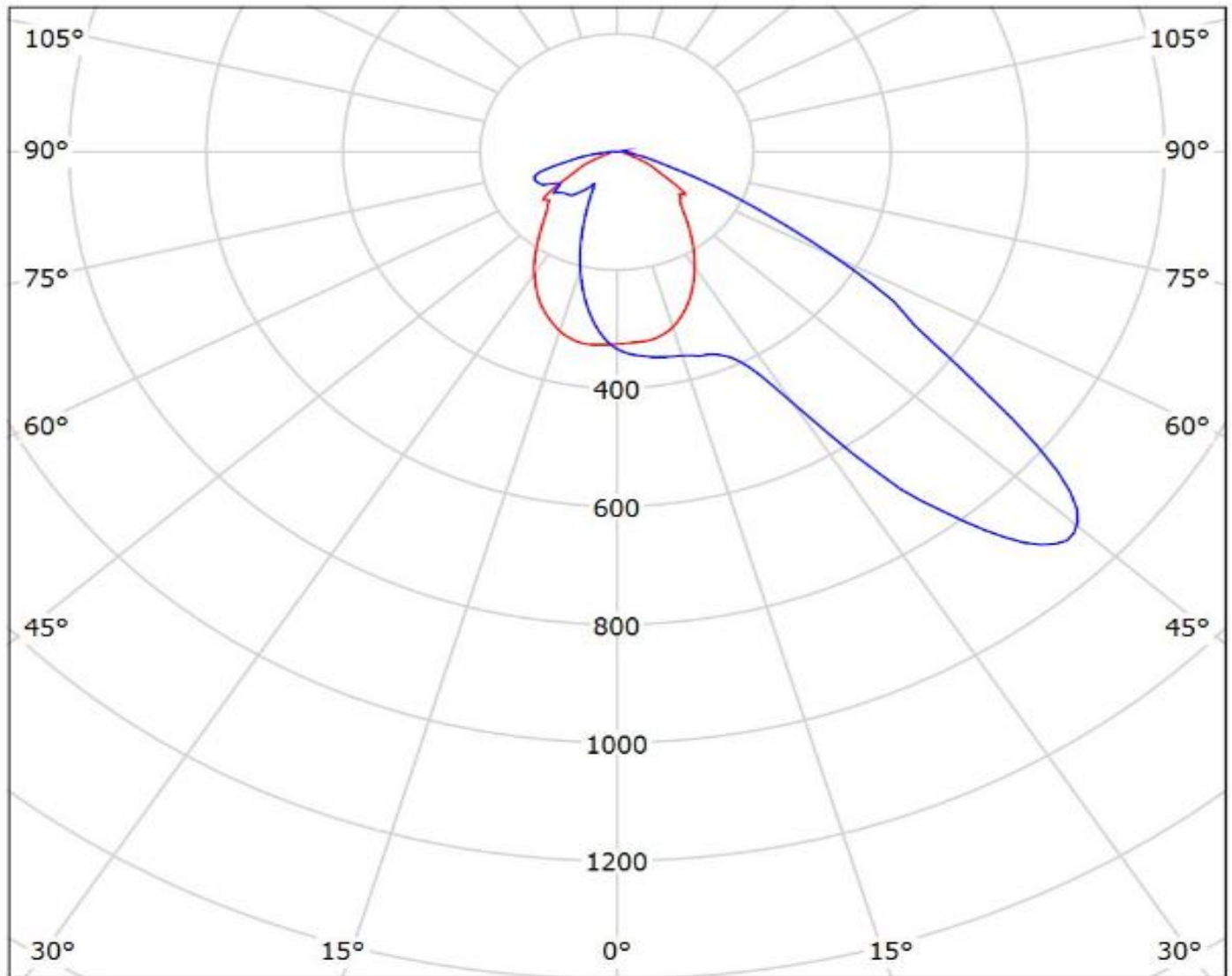

cd/klm

— C0 - C180

— C90 - C270

$\eta = 95\%$

Ledil C13604_STRADA-2X2-FN_(TL1L4) / LDC (Polar)

Luminaire: Ledil C13604_STRADA-2X2-FN_(TL1L4)

Lamps: 1 x Toshiba_TL1L4_2x2_(TL1L4-DW0)_472.639lm@250mA_CCT=6500K_P=2.9W_I=0.25A

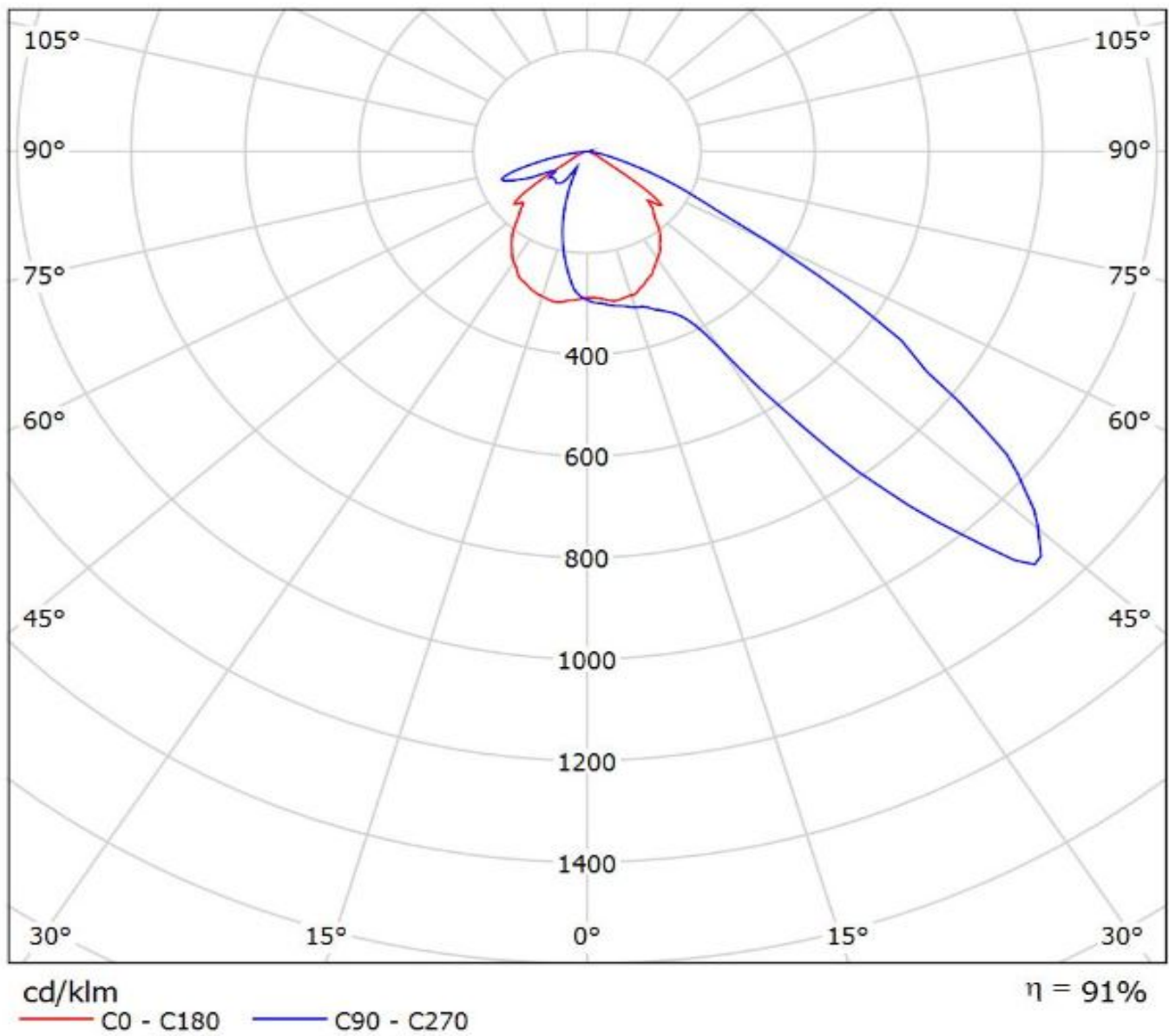

Luminaire: LEDiL Oy C13604_STRADA-2X2-FN_(Tridonic_Module_RLE_G1)
Lamps: 1 x Tridonic_Module_RLE_G1_4576.03lm@700mA_P=32.0681W_I=0.700A

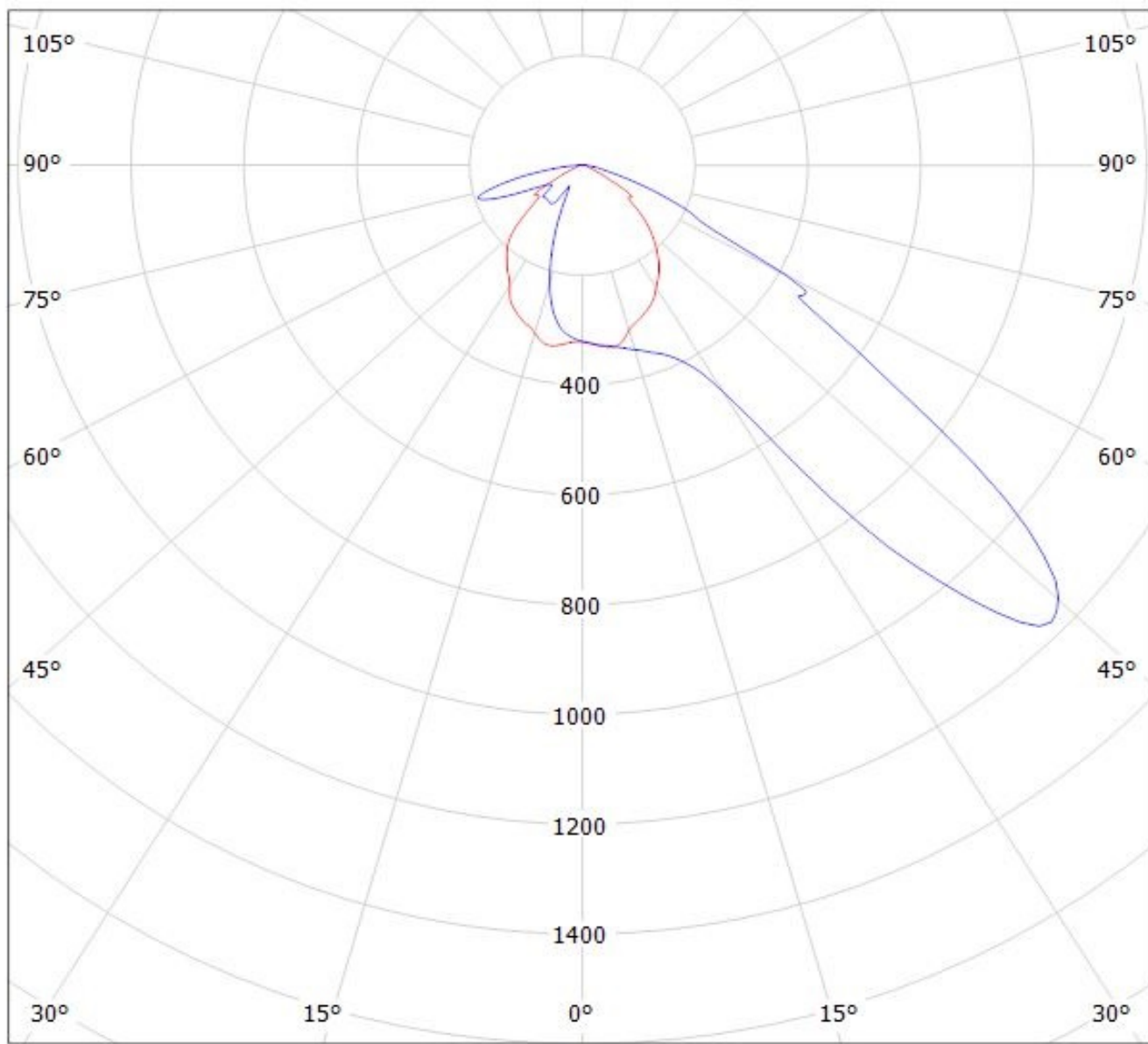

cd/klm

— C0 - C180 — C90 - C270

$\eta = 94\%$

Luminaire: LEDiL Oy C13604_STRADA-2X2-FN_(Tridonic_Module_RLE_G1)
Lamps: 1 x Tridonic_Module_RLE_G1_4576.03lm@700mA_P=32.0681W_I=0.700A

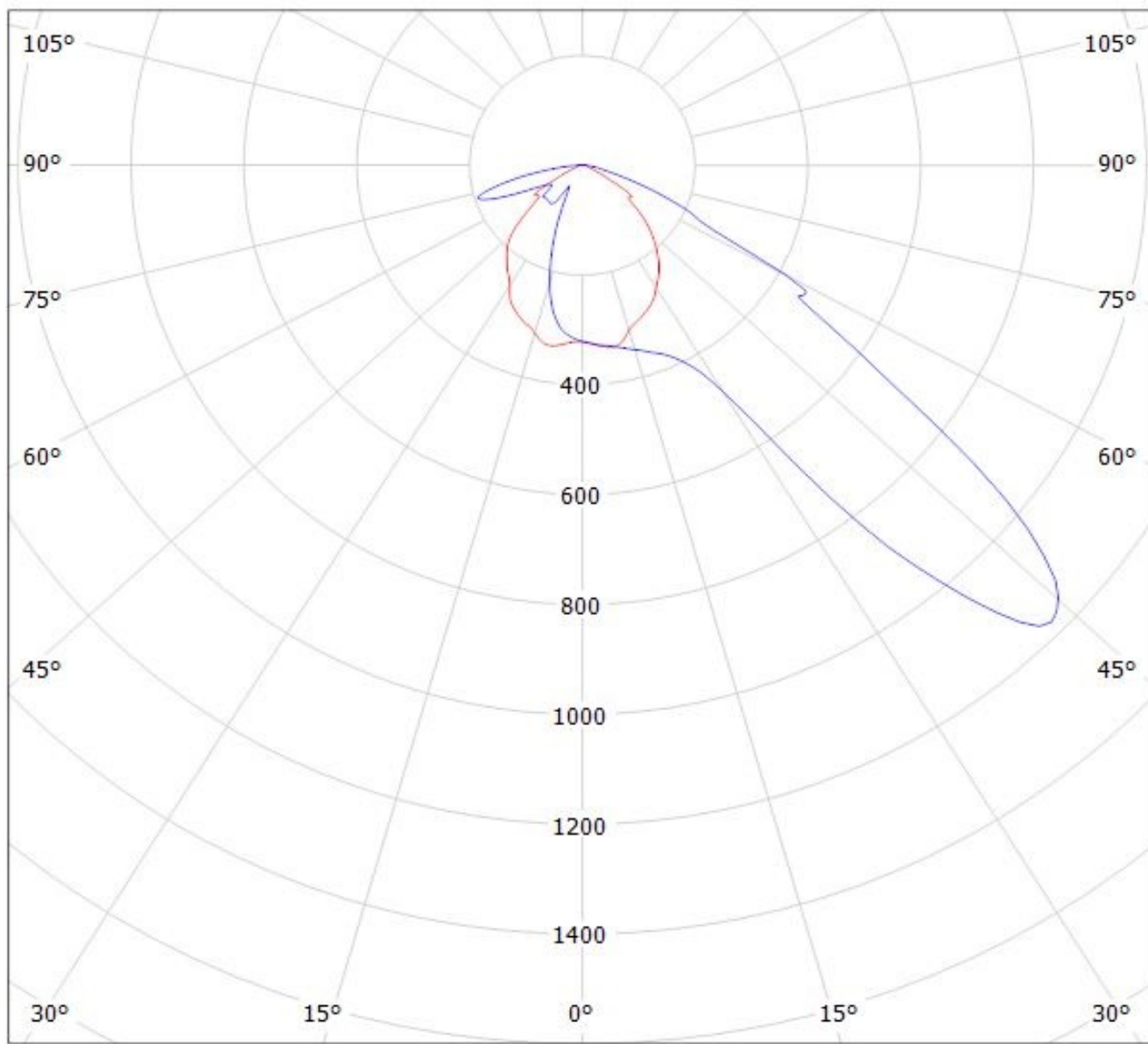

cd/klm
— C0 - C180 — C90 - C270

$\eta = 94\%$

Luminaire: LEDiL Oy C13604_STRADA-2X2-FN_(Tridonic_Module_RLE_G1)
Lamps: 1 x Tridonic_Module_RLE_G1_2288lm@700mA_P=16W_I=0.700A

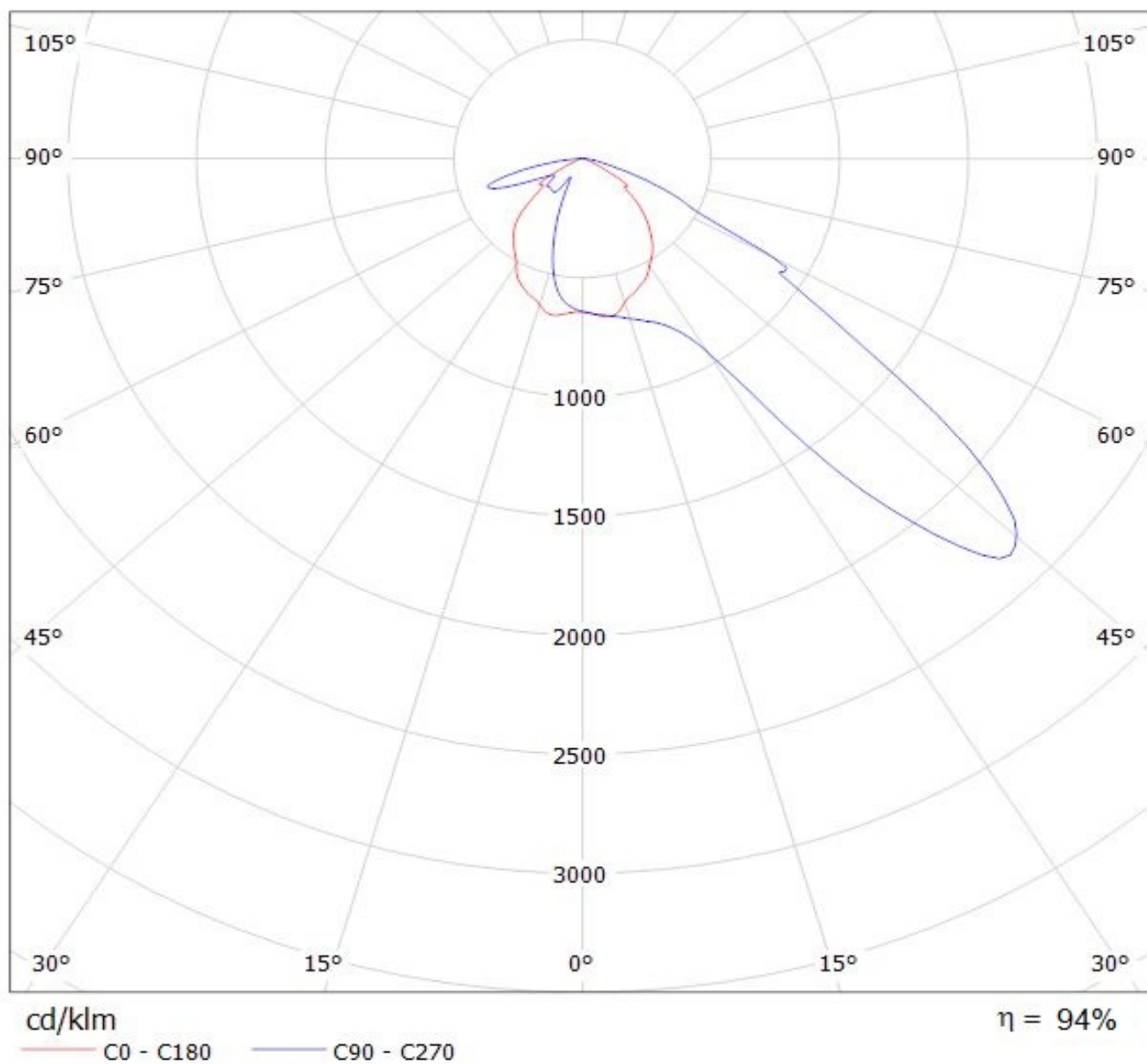

Luminaire: LEDiL Oy C13604_STRADA-2X2-FN_(Tridonic_Module_RLE_G1)
Lamps: 1 x Tridonic_Module_RLE_G1_2288lm@700mA_P=16W_I=0.700A

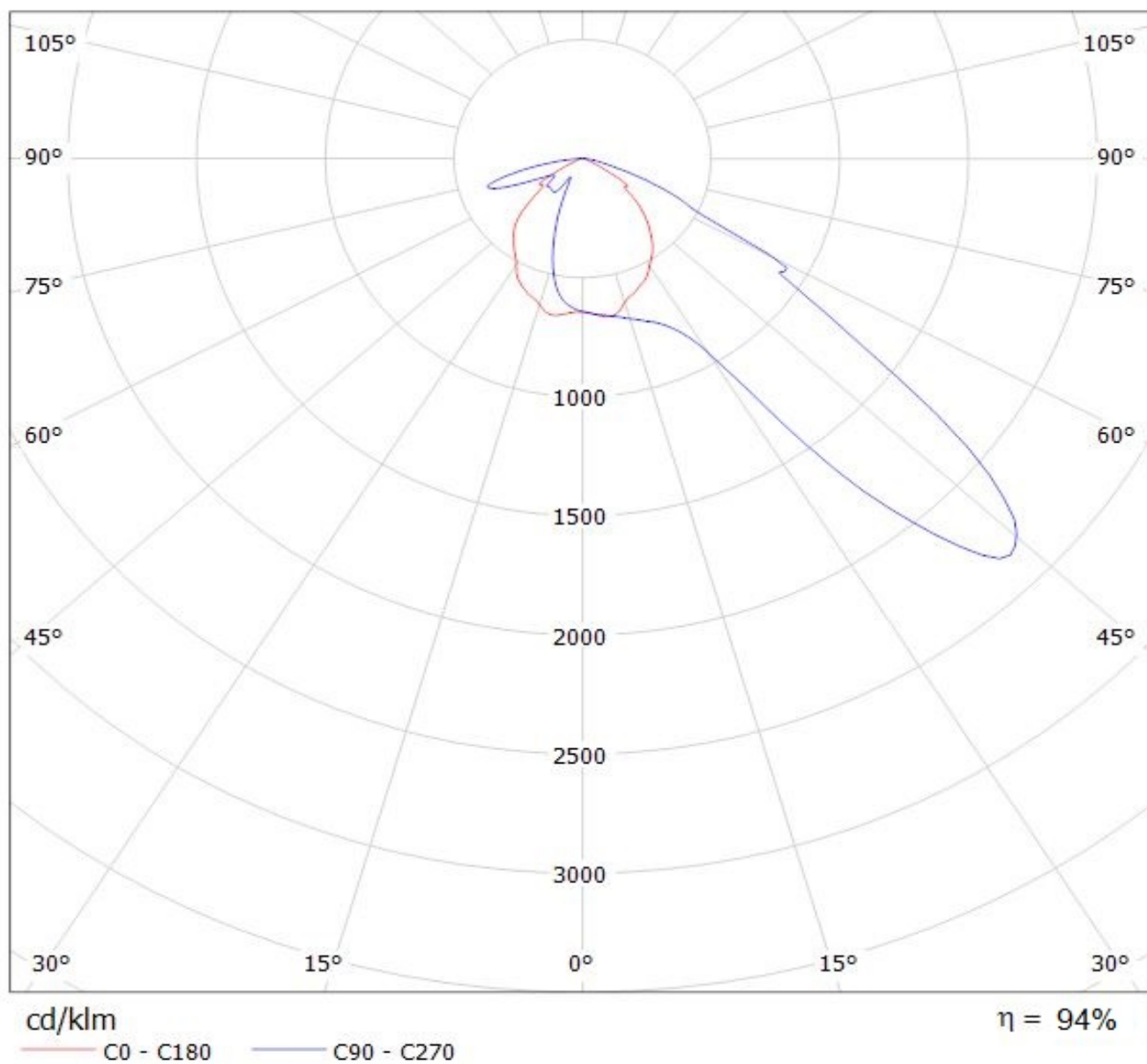

NOTE: The typical divergence will be changed by different color, chip size and chip position tolerance. The typical total divergence is the full angle measured where the luminous intensity is half of the peak value.