

Description	Material	Finish
Body	Brass	Nickel
Pin	BE CU	Gold
Insulation	PTFE	N/A
Nut	Brass	Nickel
Washer	Brass	Nickel

REVISIONS			
REV	DESCRIPTION	DATE	APPV
B	Updated footprint and dimensions; Added new title block	29-JUN-12	BPM

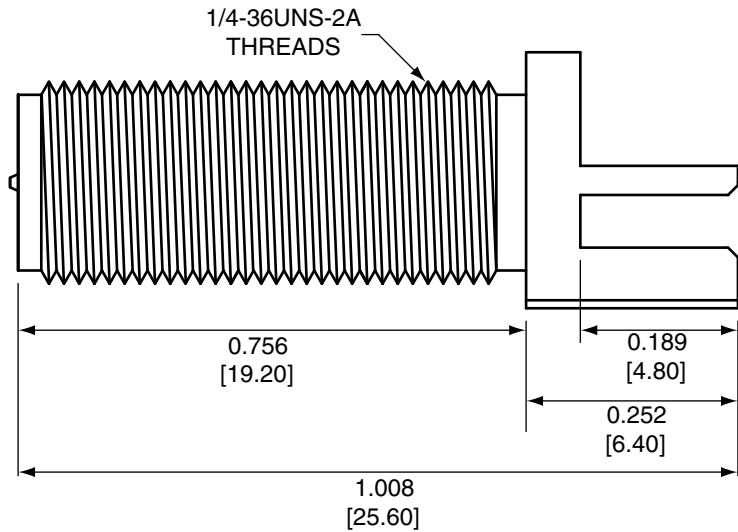

SIDE VIEW

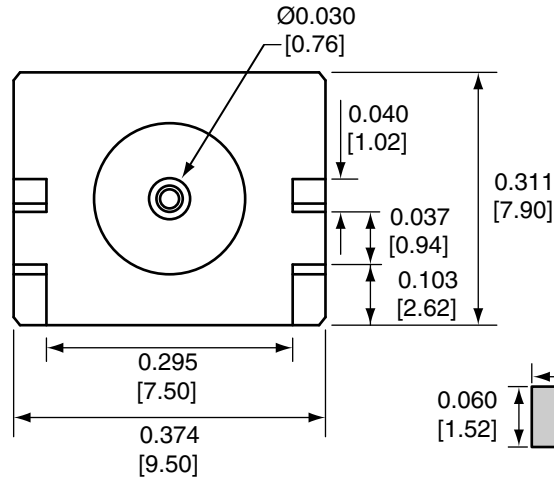

BACK VIEW

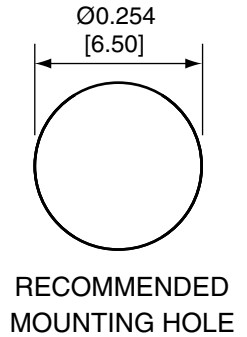

RECOMMENDED MOUNTING HOLE

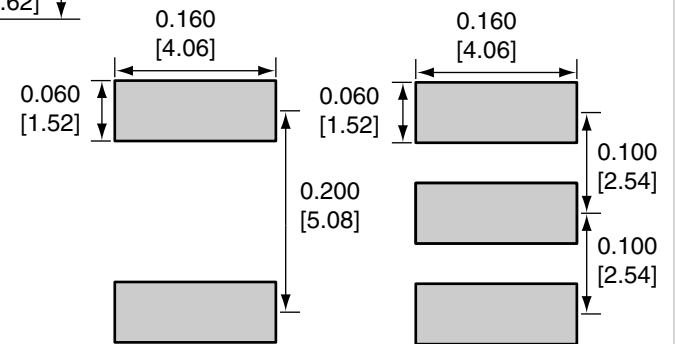

BOTTOM

TOP

RECOMMENDED FOOTPRINT

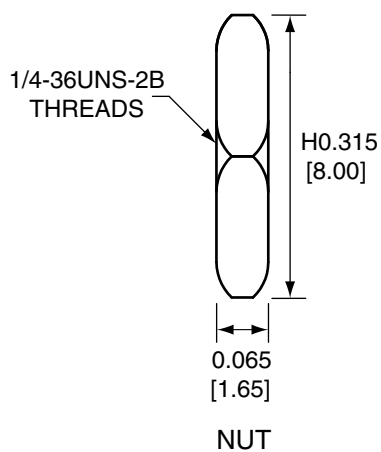

NUT

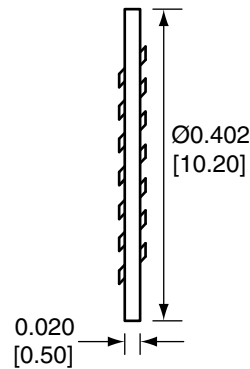

WASHER

NOTES: (UNLESS OTHERWISE SPECIFIED)

1. ALL DIMENSIONS ARE IN INCHES [mm].
2. DIMENSIONS APPLY AFTER FINISHING.
3. MANUFACTURE TO BE COMPLIANT WITH EU RoHS DIRECTIVE.
4. SAFETY BREAK ALL SHARP CORNERS AND EDGES .02 MAXIMUM.

WARNING: THIS DRAWING CONTAINS PROPRIETARY INFORMATION THAT IS THE SOLE PROPERTY OF LINX TECHNOLOGIES, AND SHALL BE TREATED AS SUCH. NO DISCLOSURE OR REPRODUCTION OF THIS DOCUMENT IS PERMITTED, IN WHOLE OR IN PART, WITHOUT THE EXPRESS WRITTEN PERMISSION OF LINX TECHNOLOGIES OR ITS DESIGNATED AGENTS.

MATERIAL:	TOLERANCES: .020 [0.50]-.200 [5.00]= ±.008 [0.20] .200 [5.00]-1.200 [30.00]= ±.016 [0.40] 1.20 [30.0]-4.75 [120.0]= ±.024 [0.60] 4.75 [120.0]-12.40 [315.0]= ±.040 [1.0]	PROJECTION: 
FINISH:	DRAWN: B.MURPHY	DT: 29-JUN-12
	ENGR: S.HOGAN	DT: 29-JUN-12

Linx		159 ORT LANE MERLIN, OR 97532	
TITLE: RP-SMA FEMALE EDGE MOUNT FOR 0.031" THICK BOARD, EXTENDED			
SIZE A	DWG. NO. CONREV SMA003.031-L	REV B	
SCALE: 2:1	DO NOT SCALE DRAWING	SHEET 1 OF 1	