

IoT off-line isolated power supply 3 W 5 V, <13 mW standby

SMPS based on CoolSET™ ICE3RBR4765JG current mode controller

About this document

Scope and purpose

This document presents one solution for a simple, low-power, offline flyback converter based on the Infineon ICE3RBR4765JG controller. It is an engineering report of features and performance for a 5 V 3 W solution, with explanations covering component selection, circuit and layout design.

The ICE3RBR4765JG is an offline SMPS current mode controller from the CoolSET™ jitter series, with integrated 650 V CoolMOS™ MOSFETs and a startup cell.

Intended audience

This document is intended for power supply design engineers, application engineers, students, etc., who wish to design low cost, highly reliable off-line Switched Mode Power Supply (SMPS) systems for:

- Applications related to the Internet of things (IoT)
 - 1) Standby power supply
 - 2) Power supply for microcontrollers
 - 3) Power supply for standalone sensors operating on a wired/wireless interface bus
- USB-power supply embedded in a wall plug
- Intelligent wall plug switched by wireless (with relay)
- Metering application
- General Applications with small formfactor in the power range 1 W to 3 W.

Table of contents

Table of contents

About this document	1
1 Introduction	3
2 Technical specification	4
3 List of product features – ICE3RBR4765JG	5
4 Circuit description.....	6
4.1 Circuit diagram.....	6
4.2 Introduction.....	6
4.3 Line input rectification	6
4.4 Primary side EMI filter	6
4.5 Primary side snubber	7
4.6 Power supply for CoolSET™ controller	7
4.7 Secondary side rectification	7
4.8 Feedback loop circuit.....	8
5 CoolSET™ ICE3RBR4765JG controller	9
5.1 Start up	9
5.2 Peak primary current control	9
5.3 Active Burst Mode (ABM)	10
5.4 Protection modes and auto restart	10
6 PCB Layout.....	12
7 Bill of materials	13
8 Transformer specification	14
8.1 Electrical diagram	14
8.2 Electrical specification	14
8.3 Material	14
8.4 Transformer build diagram.....	15
8.5 Transformer design by Würth Elektronik	15
9 Test results.....	16
9.1 Efficiency.....	16
9.2 No-load power consumption	17
9.3 Light load power consumption.....	17
9.4 Line and load regulation	18
9.5 Output voltage ripple	19
9.6 Thermal performance	19
10 Waveforms	20
10.1 Switching waveforms at steady state.....	20
10.2 Startup.....	20
10.3 Output voltage ripple	21
10.4 Active burst mode	22
10.5 Load transient response	23
10.6 Output voltage overshoot and undershoot	23
11 Conducted EMI.....	26
12 References	27
Revision history	28

Introduction

1 Introduction

This is an engineering report for a 5 V, 3 W offline flyback power supply. This document contains the technical specification for the power supply, a list/description of the main features, circuit and layout description as well as the measurement results.

In this application, an Infineon ICE3RBR4765JG from the CoolSET™ jitter series is used as a flyback controller. The controller has a built-in 650 V CoolMOS™ as the main switching component, as well as the startup cell. The reference design board operates in Discontinuous Conduction Mode (DCM), running at 65 kHz switching frequency. The output is a single 5 V / 600 mA, generated by secondary side regulation. Active Burst Mode (ABM) operation provides very low standby power consumption (less than 13 mW over input voltage range 180 V_{ac} ~ 265V_{ac}). Low EMI is achieved by built-in frequency jitter and soft start operation.

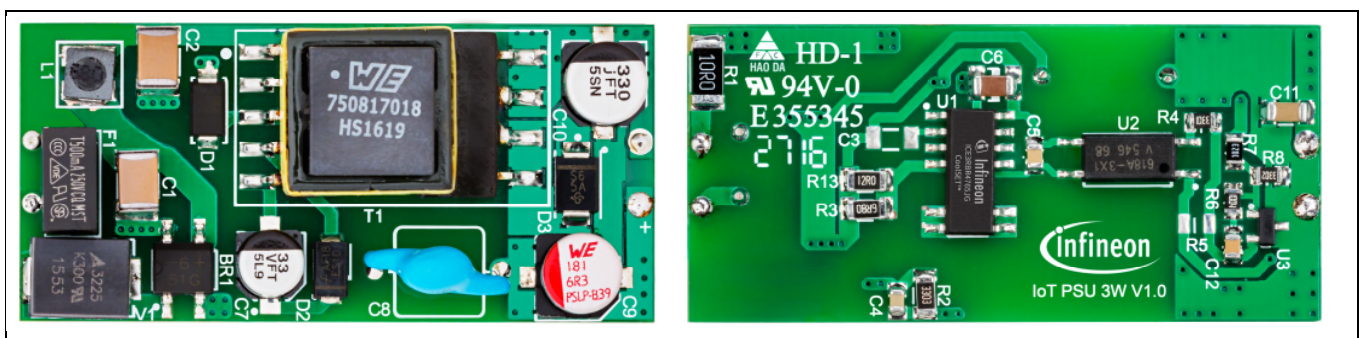

Figure 1 Top and bottom side of the reference design board

2 Technical specification

Table 1 Power supply technical specification

Input voltage	180 V _{ac} ~ 265 V _{ac}
Line frequency	50 Hz, 60 Hz
Output voltage	5 V ±5%
Rated output current	600 mA
Rated output power	3 W
Efficiency	79% @ 230 V _{ac} , full load
Output voltage ripple (max.)	<80 mVpp
No load power consumption @Vin: 180Vac ~ 265Vac	<13 mW
Power consumption at 10 mA load	<100 mW
Device dimensions	50 mm x 23.5 mm x 14 mm (L x W x H)
Isolation	Reinforced isolation between primary and secondary side

3 List of product features – ICE3RBR4765JG

Table 2 List of features

650 V avalanche rugged CoolMOS™ with built-in startup cell
Active Burst Mode (ABM) for lowest standby power
65 kHz internally fixed switching frequency
Auto restart protection mode for overload, open loop, V_{CC} undervoltage, overtemperature and V_{CC} overvoltage
Built-in soft start
Fast load jump response in Active Burst Mode (ABM)
Internal PWM leading edge blanking
Built-in frequency jitter feature and soft driving for low EMI
BiCMOS technology provides wide V_{CC} range

Circuit description

particularly for the small package size. With an input voltage of 180 V_{ac} and a full load, C1 and C2 will discharge to approximately 180 V. The maximum value of the rectified voltage is 375 V for a 265 V_{ac} input.

4.5 Primary side snubber

When the CoolMOS™ MOSFET turns off, a high drain voltage spike occurs - caused by the transformer leakage inductance. These oscillations are damped by the RC snubber. D1 is a high voltage ultrafast diode with a very short recovery time. C4 is selected based on the oscillation period and the voltage overshoot on the CoolMOS™ MOSFET drain. R2's value and its power rating depend on the maximum peak current through the primary inductance and the CoolMOS™ MOSFET voltage overshoot. The design margin for the CoolMOS™ MOSFET drain to source voltage must be maintained at all operating points. The snubber also suppresses radiated EMI.

4.6 Power supply for CoolSET™ controller

When the input voltage is applied, the IC starts to charge its V_{CC} capacitor through the built-in startup cell. The startup cell is activated if the V_{CC} voltage is below the undervoltage threshold level of 10.5 V. V_{CC} charge current is controlled to 0.9 mA by the startup cell. The startup cell remains active until the V_{CC} voltage exceeds the on-threshold of 18 V, when the chip starts to operate and the startup cell is turned off. By implementing hysteresis for the startup V_{CC} voltage, an uncontrolled ringing when switching on is avoided.

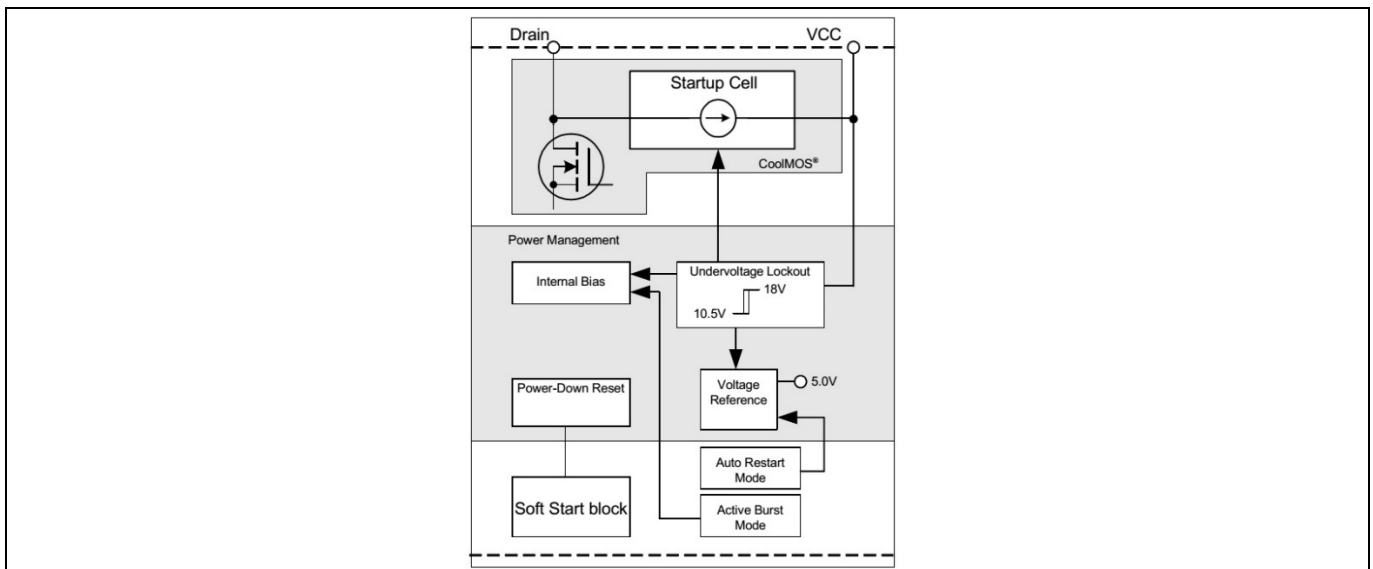

Figure 3 Power management of the IC

In order to achieve the lowest power consumption, V_{CC} is set as low as possible within a defined range. Due to the tolerance of the IC, especially the undervoltage lockout level (which can be as high as 11.2 V), a safe margin for V_{CC} is taken into account when the transformer auxiliary winding is determined. Capacitors C6 and C7 are selected to be sufficient to keep V_{CC} above this safe margin during the discharge phase, when the IC is not in a steady state. The V_{CC} capacitance must not be unnecessarily large with respect to the startup time. In steady state conditions V_{CC} is stable as the IC is supplied from the auxiliary winding.

4.7 Secondary side rectification

The secondary side rectification circuit is a simple diode rectifier with filter capacitors. Diode D3 is a Schottky type, selected to meet the current and reverse voltage requirements. Its low forward voltage reduces the power loss in D3, and therefore lowers its temperature and improves the overall efficiency.

Circuit description

Selection of output capacitors C9 and C10 directly affects the output voltage ripple, standby power consumption and the repetition time period during active burst mode. In general, large output capacitors reduce the output voltage ripple and increase the repetition time period which, in turn, reduces the standby power consumption. However, too large an output capacitance leads to a very slow V_{out} discharge at extremely light load or open load. If V_{CC} discharges and triggers the UVLO before the IC enters active burst mode, the IC may be trapped in an endless auto restart mode and never enters active burst mode.

The output voltage ripple is reduced by selecting an ultra low-ESR capacitor. Typically, capacitors with ultra low ESR have relatively high leakage current that increases standby power consumption significantly. By combining one ultra low-ESR capacitor and one regular capacitor, maximum output voltage ripple is less than 80 mVpp and the standby power consumption is less than 13 mW.

4.8 Feedback loop circuit

The major requirement for the feedback loop is to match the dynamically varying load and provide stable system control. The output voltage is sensed using an LMV431 precision shunt regulator (1% initial tolerance, 1.24 V reference voltage), which has a low operating current (55 μ A). Resistors R7 and R8 set the output voltage to 5 V. The resistance of R7 and R8 should be selected to be as large as possible to reduce the standby power consumption while not being so large that they affect control stability. R4 determines the optocoupler (U2) diode current - this is important for fast transient response and as well for standby power consumption. Optocoupler U2 is selected based on its Current Transfer Ratio (CTR) and low input current while ensuring the package permits a suitable creepage distance.

In terms of component selection, the feedback loop circuitry is the most complicated to calculate as the open load power consumption must be very low. Additionally, output voltage regulation, load transient response, stability, output voltage ripple and burst mode repetition time depend on the feedback loop. Therefore, most component values in the feedback loop are determined by testing.

5 CoolSET™ ICE3RBR4765JG controller

The ICE3RBR4765JG controller belongs to the CoolSET™ jitter series and includes built-in features for soft start, blanking window, frequency jitter, active burst mode, propagation delay compensation, modulated gate driving and auto-restart when protection features are triggered.

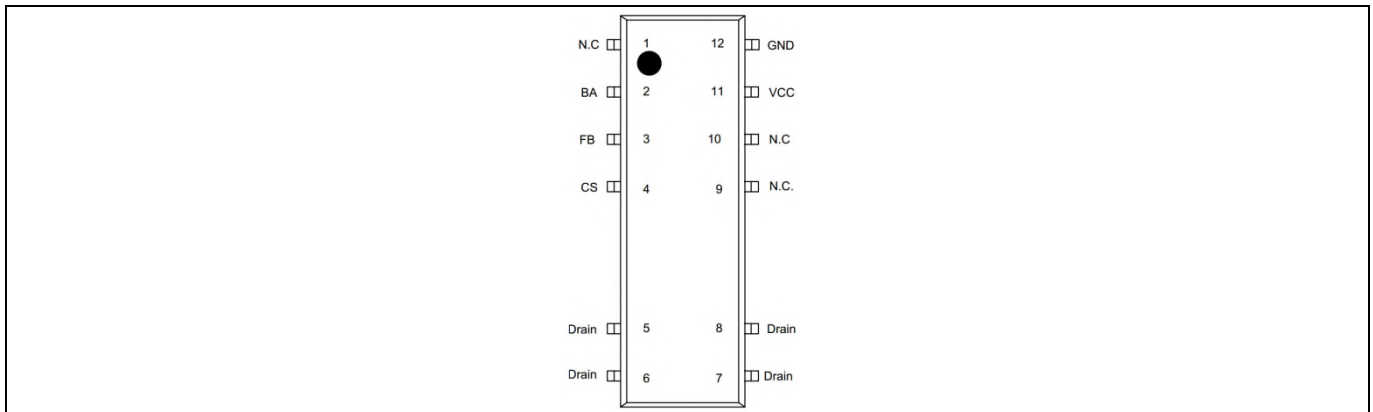

Figure 4 Pin configuration PG-DSO-12

For full details about the ICE3RBR4765JG controller, see [1].

5.1 Start up

The built-in startup cell is sufficient for the ICE3RBR4765JG to start without external startup resistors. The startup cell connects the drain pin to the V_{CC} pin of the IC and charges the external capacitors to 18 V when the IC starts switching. At this point, the V_{CC} pin is supplied from the auxiliary winding.

In the startup phase, the IC provides a soft start function to gradually increase the primary current by increasing the duty cycle in 32 steps. The soft start phase finishes 20 ms after the IC is switched on (V_{CC} exceeds 18 V).

In addition to start up, the soft start function is also activated at a restart attempt during auto restart. This means that the converter transfers a significant amount of energy to the secondary side every time the IC restarts. As a consequence, when the output is open and the input voltage is interrupted significant output voltage overshoot can occur if the feedback loop response is not sufficiently fast, as the converter is charging the output capacitors even though the output voltage is close to V_{out} nominal.

5.2 Peak primary current control

The primary current is sensed by the external shunt resistors, R3 and R13. This signal is amplified and then compared with the feedback signal for cycle by cycle peak current limit operation. If the amplified current sense signal exceeds the feedback signal, the on-time T_{on} of the driver is closed.

Resistors R3 and R13 determine the maximum peak current of the integrated CoolMOS™ MOSFET and, as a result, the maximum output power is limited. Overload protection is triggered if the current sense voltage exceeds the threshold $V_{csth}=1.03$ V. Integrated propagation delay compensation reduces the influence of the AC input voltage on the maximum output power. Leading edge blanking is integrated to protect the current limit from distortions caused by leading edge spikes.

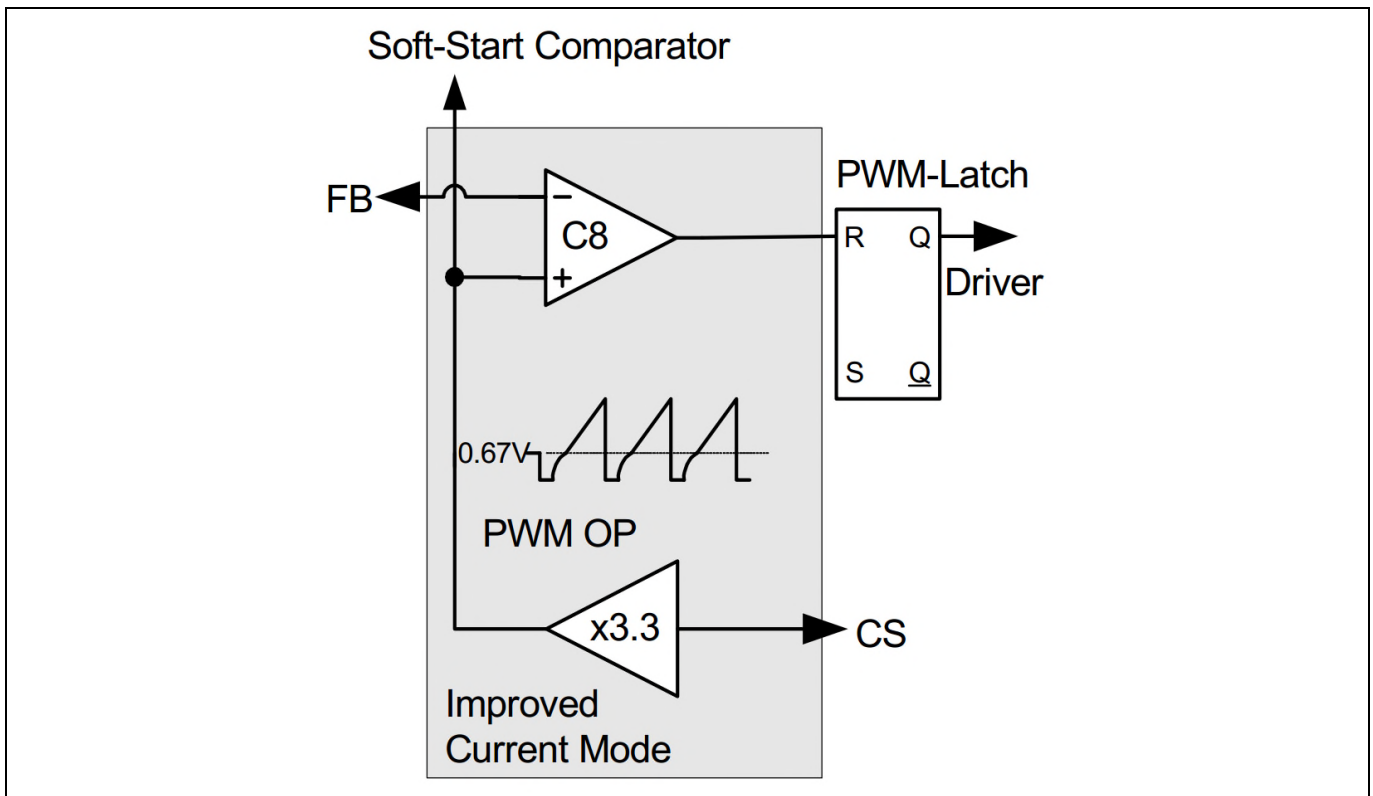

Figure 5 Current mode

In active burst mode, the peak primary current limit is reduced to $V_{CS}=0.34\text{ V}$. Thus, the conduction loss and audible noise is reduced.

5.3 Active Burst Mode (ABM)

The system enters ABM under low load conditions. With ABM, the efficiency increases significantly at light load while still maintaining a low ripple on V_{OUT} and a fast response on step changes in load. The significant feature is the extremely low standby power consumption: <13 mW at $180\text{ V}_{ac}\sim 265\text{ V}_{ac}$.

The system will enter ABM if the feedback signal falls and remains below 1.35 V for the 20 ms blanking time. This time window prevents ABM being entered due to large step changes in load. When ABM is entered, the current consumption of the IC is reduced to approximately 450 μA . During ABM, V_{CC} must be kept above the undervoltage lockout level of 10.5 V to prevent the startup cell from switching on and the IC from restarting. The feedback signal is a sawtooth between 3.5 V when the IC starts switching and 3.0 V when the IC stops switching. The feedback signal will increase immediately if there is a step change in load. The system will exit the ABM when the feedback signal exceeds 4.0 V.

5.4 Protection modes and auto restart

The IC provides an auto restart mode as a protection feature to prevent damage of the device. Table 3 shows possible system failures, conditions and corresponding protection modes.

Table 3 System failures and protection modes

Protection function	Failure condition	Protection mode
V _{CC} overvoltage	1. V _{VCC} > 20.5 V & FB > 4 V & during soft start period & last for 30 μs 2. V _{VCC} > 25.5 V & last for (120+30) μs (inactive during burst mode)	Auto restart
Overtemperature (controller junction)	T _J > 140°C & last for 30 μs	Auto restart
Overload/open loop	V _{FB} > 4 V & last for 20 ms & V _{BA} > 4.0 V & last for 30 μs (extended blanking time counted from charging V _{BA} from 0.9 V to 4.0 V)	Auto restart
V _{CC} Undervoltage/short optocoupler	V _{VCC} < 10.5 V & last for 10 ms + 30 μs	Auto restart
Auto restart enable	V _{BA} < 0.33 V & last for 30 μs	Auto restart

When the system enters the auto restart mode, the IC will be off. At this point switching stops and V_{CC} starts to drop. When V_{CC} reaches the turn-off threshold of 10.5 V, the startup cell will turn on and start to charge V_{CC} up to the turn-on threshold of 18 V, allowing the IC to turn on again. After the startup phase, if the fault condition still exists, the IC will enter auto restart mode once again, otherwise the system will resume normal operation.

6 PCB Layout

The printed circuit board (PCB) is dual layer, double sided, and manufactured with the standard 1.5 mm thickness and 1oz copper. Between the primary and secondary side, the creepage distance is created according to requirements for reinforced isolation. The overall PCB size is 50 mm x 23.5 mm.

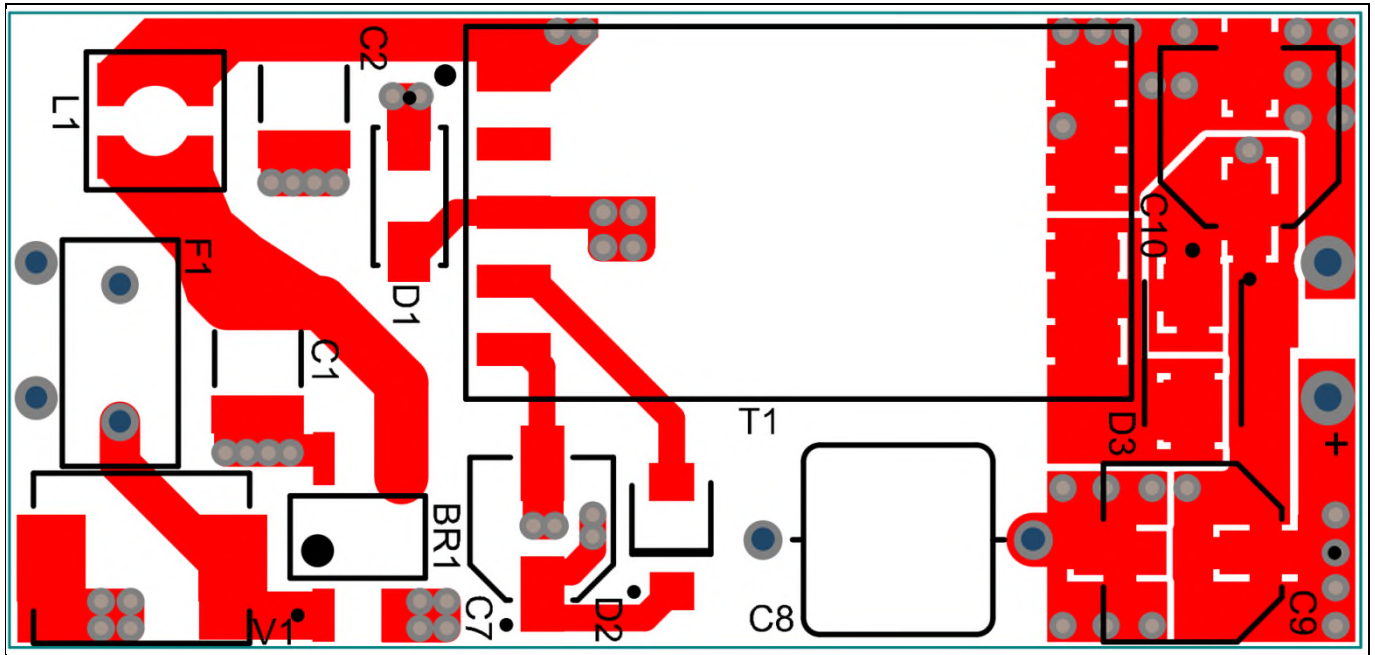

Figure 6 Layout top

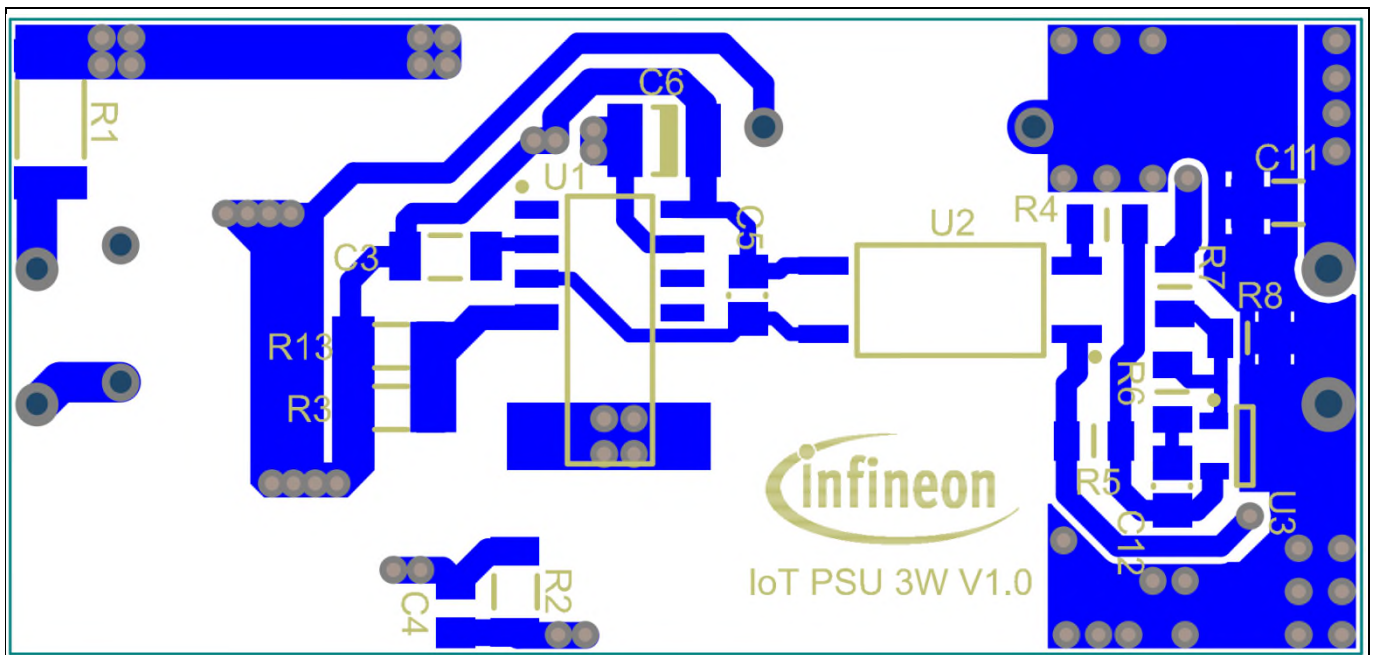

Figure 7 Layout bottom

7 Bill of materials

Table 4 Bill of materials

Component designator	Description	Manufacturer	Manufacturer part number
BR1	Bridge rectifier, 600 V, 0.5 A, TO-269AA	Vishay	MB6S-E3/45
C1, C2	Capacitor ceramic, 1 μ F, 450 V, 1812	TDK	CKG45NX7T2W105M500JH
C4	Capacitor ceramic, 2200 pF, 250V, 0805	Murata	GRJ21AR72E222KWJ1D
C5	Capacitor ceramic, 1 nF, 50 V, 0805		standard capacitor
C6	Capacitor ceramic, 4.7 μ F, 50 V, 1206		standard capacitor
C7	Capacitor electrolytic, 33 μ F, 35 V, SMD	Panasonic	EEE-FT1V330AR
C8	Capacitor ceramic, 1000 pF, 250 V, X1/Y1	Murata	DE1E3KX102MA4BN01F
C9	Capacitor electrolytic, 180 μ F, 6.3 V, SMD	Würth Elektronik	875105144007
C10	Capacitor electrolytic, 330 μ F, 6.3 V, SMD	Panasonic	EEEFT0J331AP
C11	Capacitor ceramic, 10 μ F, 25 V, 1206	Würth Elektronik	885012108021
C12	Capacitor ceramic, 33 nF, 50 V, 0805		standard capacitor
D1	Diode ultrafast, 600 V, 1 A, DO-214AC	STMicroelectronics	STTH1R06A
D2	Diode ultrafast, 200 V, 1 A, DO-214AC	Fairchild	ES1D
D3	Diode Schottky, 60 V, 2 A, DO-214AA	Vishay	SS26-E3/52T
F1	Fuse slow blow, 250 V, 0.5 A, TH	Multicomp	MST 500MA 250V
L1	Inductor, 68 μ H, 320mA, 3816	Würth Elektronik	744031680
R1	Resistor, 10 Ω , 300 V, 2010	Vishay	CRCW201010R0FKEF
R2	Resistor, 330 k Ω , 200 V, 1%, 1206		standard resistor
R3	Resistor, 6.8 Ω , 1%, 1206		standard resistor
R4	Resistor, 3.3 k Ω , 1%, 0805		standard resistor
R6	Resistor, 1 M Ω , 1%, 0805		standard resistor
R7	Resistor, 102 k Ω , 1%, 0805		standard resistor
R8	Resistor, 33 k Ω , 1%, 0805		standard resistor
R13	Resistor, 12 Ω , 1%, 1206		standard resistor
TR1	Transformer, 2.2 mH, EE13/7/4	Würth Elektronik	750817018
U1	IC, ICE3RBR4765JG, PG-DSO-12	Infineon	ICE3RBR4765JG
U2	Optocoupler, VOL618A, LSOP 4	Vishay	VOL618A-3X001T
U3	IC, LMV431, SOT-23-3	Texas Instruments	LMV431AIMF/NOPB
V1	Varistor, CU3225K300G2	Epcos	B72650M0301K072

Transformer specification

8 Transformer specification

8.1 Electrical diagram

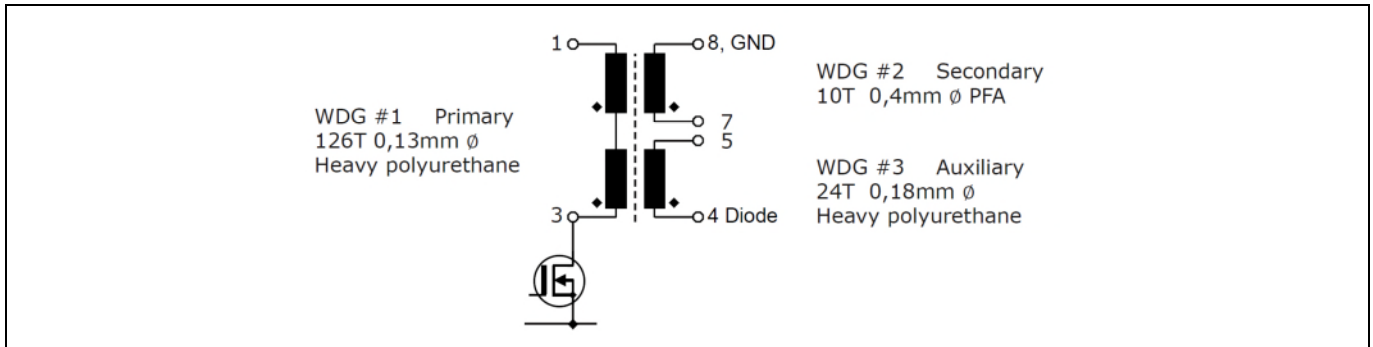

Figure 8 Transformer electrical diagram

8.2 Electrical specification

Table 5 Transformer electrical specification

Primary inductance	Pins 1-3, measured when all other windings are open	2.2 mH
Number of primary turns	Pins 1-3	126
Number of secondary turns	Pins 7-8	10
Number of auxiliary turns	Pins 4-5	24

8.3 Material

Table 6 Transformer material

Core	EE13/7/4, N87 material, air gap 0.099 mm
Coil former	EE13/7/4, SMD 9 pins, for reinforced insulation
Wire for primary winding	0.13 mm dia., heavy polyurethane insulated wire
Wire for secondary winding	0.4 mm dia., PFA insulated wire
Wire for auxiliary winding	0.18 mm dia., heavy polyurethane insulated wire
Insulation tape	Polyester film tape

Transformer specification

8.4 Transformer build diagram

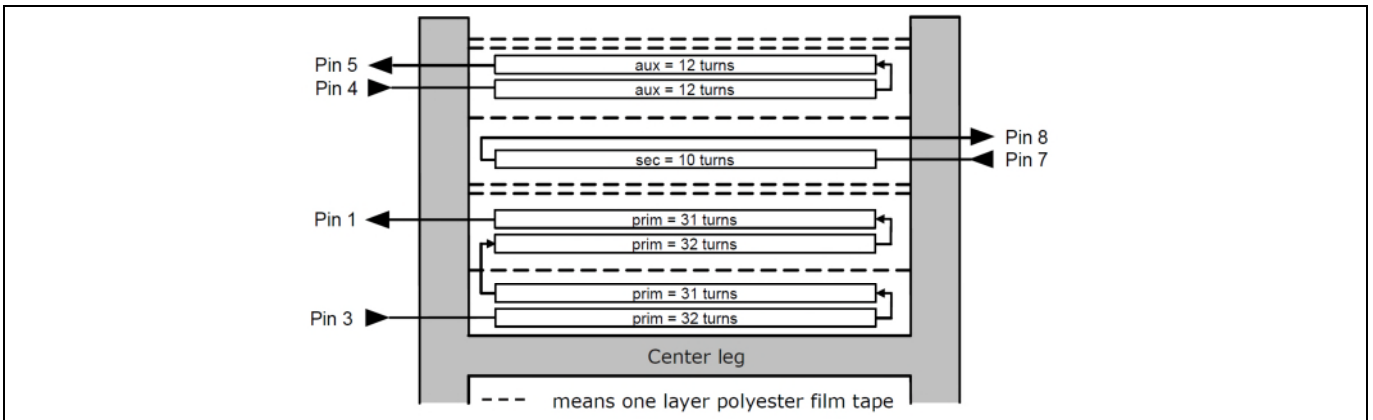

Figure 9 Transformer build diagram

8.5 Transformer design by Würth Elektronik

CUSTOMER TERMINAL Sn96%, Ag4%	RoHS Yes	LEAD(Pb)-FREE Yes	
---	--------------------	-----------------------------	--

TERM. NO.'s FOR REF. ONLY

AREA REPRESENTS TERMINAL PAD DIMENSIONS

REFERENCE LAND SIZE CUSTOMER TO DETERMINE LAND LAYOUT

ELECTRICAL SPECIFICATIONS @ 25°C unless otherwise noted:

PARAMETER	TEST CONDITIONS	VALUE
D.C. RESISTANCE	3-1 @20°C	3.790 ohms ±10%
D.C. RESISTANCE	4-5 @20°C	0.479 ohms ±10%
D.C. RESISTANCE	7-8 @20°C	0.038 ohms ±20%
INDUCTANCE	3-1 10kHz, 100mVAC, Ls	2.19mH ±10%
SATURATION CURRENT	3-1 20% rolloff from initial	250mA
LEAKAGE INDUCTANCE	3-1 tie(4+5, 7+8), 100kHz, 100mVAC, Ls	43uH typ., 56uH max.
DIELECTRIC	1-8 3750VAC, 1 second	-
DIELECTRIC	1-5 625VAC, 1 second	-
TURNS RATIO	(3-1):(7-8)	12.6:1, ±1%
TURNS RATIO	(3-1):(4-5)	5.25:1, ±1%

GENERAL SPECIFICATIONS:
OPERATING TEMPERATURE RANGE: -40°C to +125°C including temp rise.

Designed to comply with the following requirements as defined by IEC60950-1, EN60950-1, UL60950-1/CSA60950-1 and AS/NZS60950.1:
- Reinforced insulation for a primary circuit at a working voltage of 265Vrms, 400Vpeak, Overvoltage Category II.

Wire insulation & RoHS status not affected by wire color.
Wire insulation color may vary depending on availability.

DETAILS SUBJECT TO CHANGE

REV.	DATE	Packaging Specifications Method: Tape & Reel PKG-1043 www.we-online.com/midcom		Tolerances unless otherwise specified: Angles: ±1° Fractions: ±1/64 Decimals: ±.005 [.13] Footprint: ±.005 [.13]	DRAWING TITLE TRANSFORMER	PART NO. 750817018
6A	4/16	SEE REVISION SHEET FOR REVISION LEVEL	CONVERSION PLACEMENT	This drawing is dual dimensioned. Dimensions in brackets are in millimeters.	eiSos p/n: 750817018	SPECIFICATION SHEET 1 OF 1

Figure 10 Transformer design by Würth Elektronik

Test results

9 Test results

9.1 Efficiency

Efficiency measurements are performed at room temperature in steady state. The line frequency is 50 Hz.

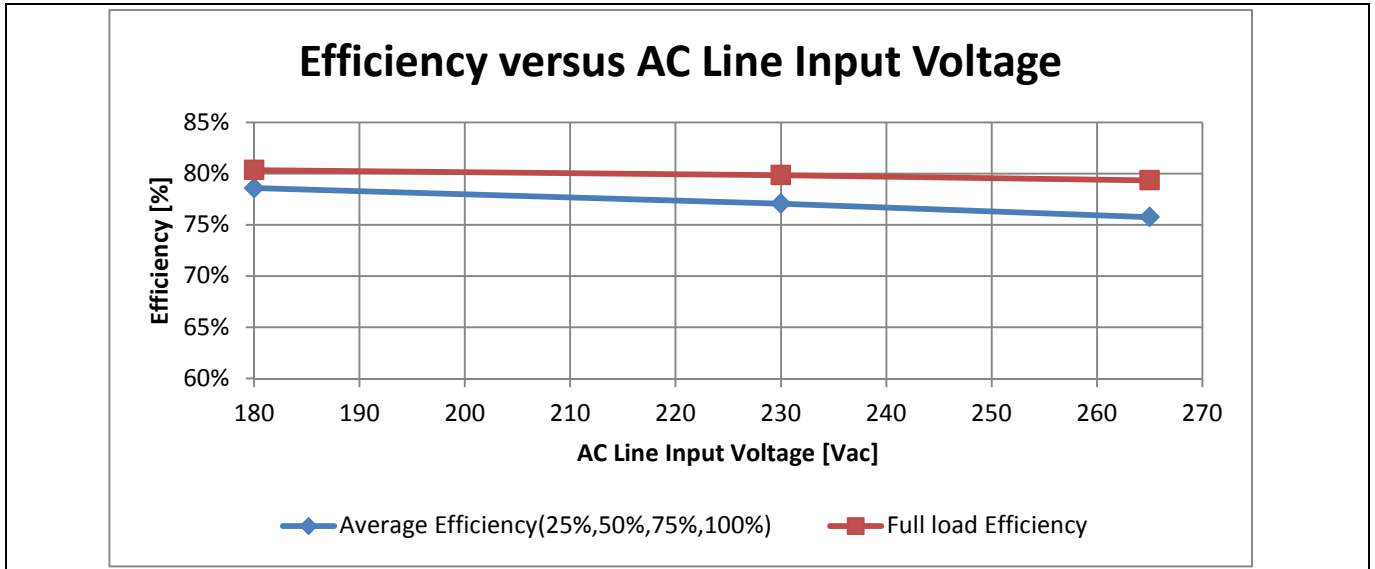

Figure 11 Efficiency versus input voltage

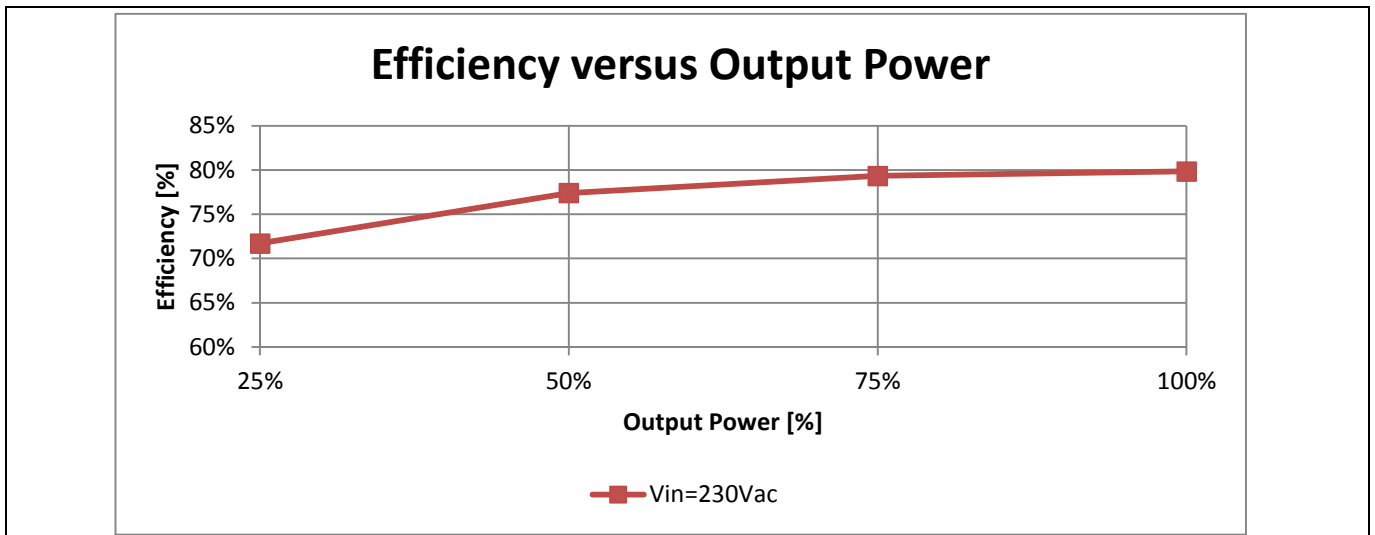

Figure 12 Efficiency versus output power

Test results

9.2 No-load power consumption

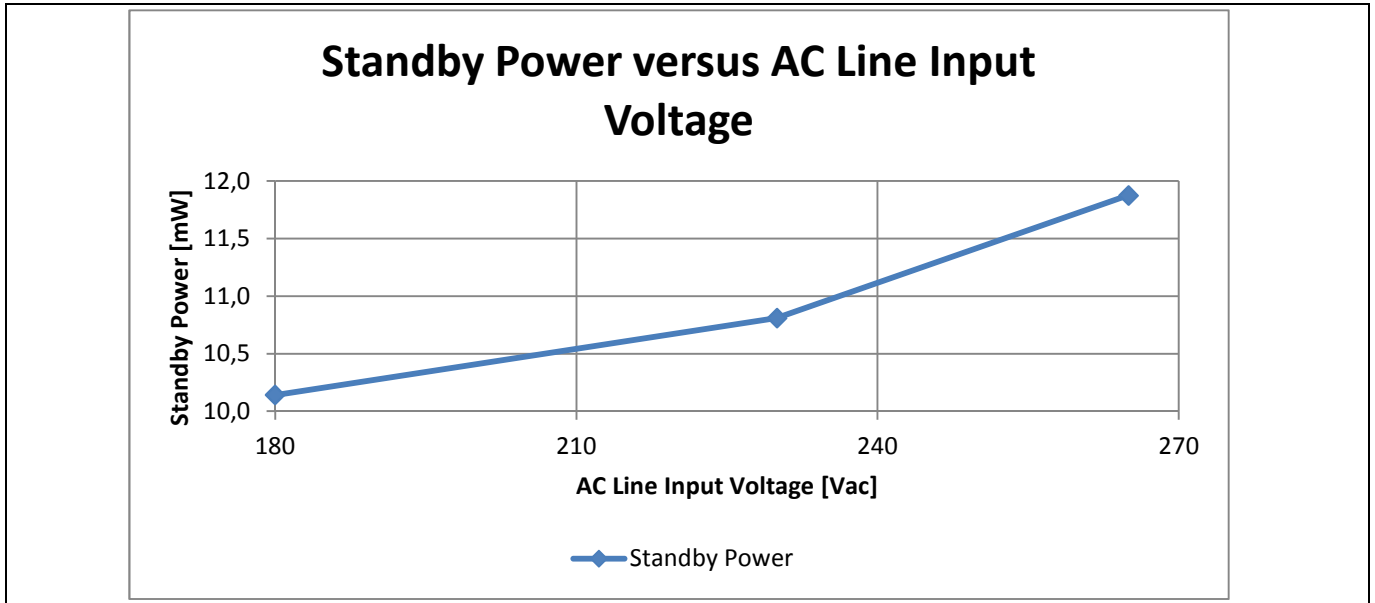

Figure 13 No-load input power consumption versus input voltage

Power consumption without load is measured with the power analyzer YOKOGAWA WT3000, using the integration function for the duration of one minute.

9.3 Light load power consumption

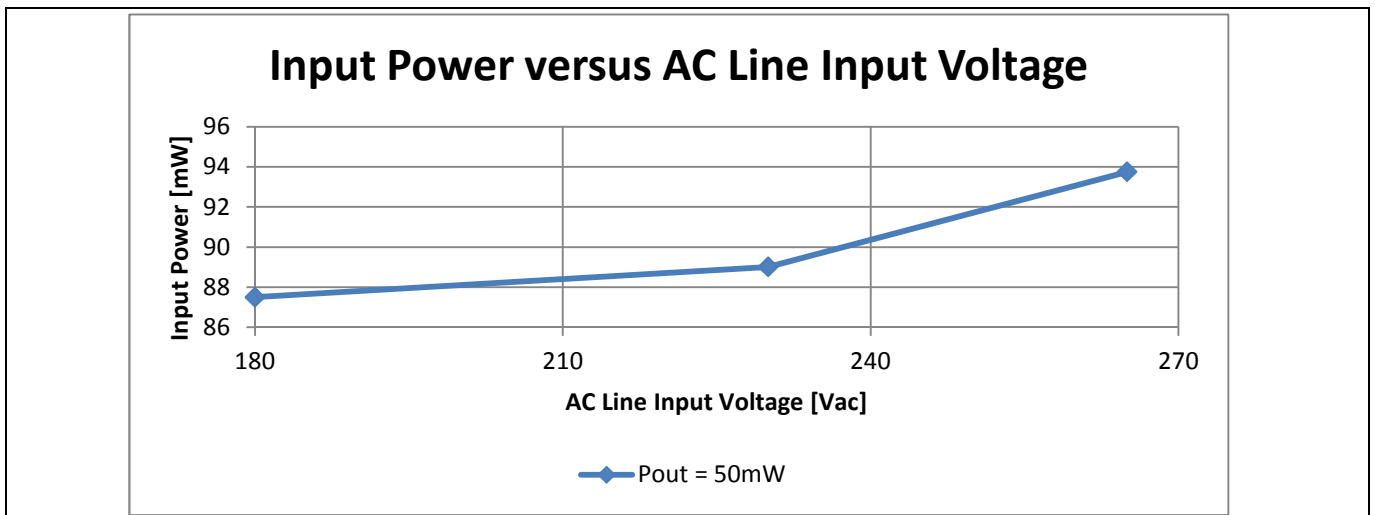

Figure 14 Power consumption versus input voltage when $P_{OUT}=50\text{ mW}$

Test results

9.4 Line and load regulation

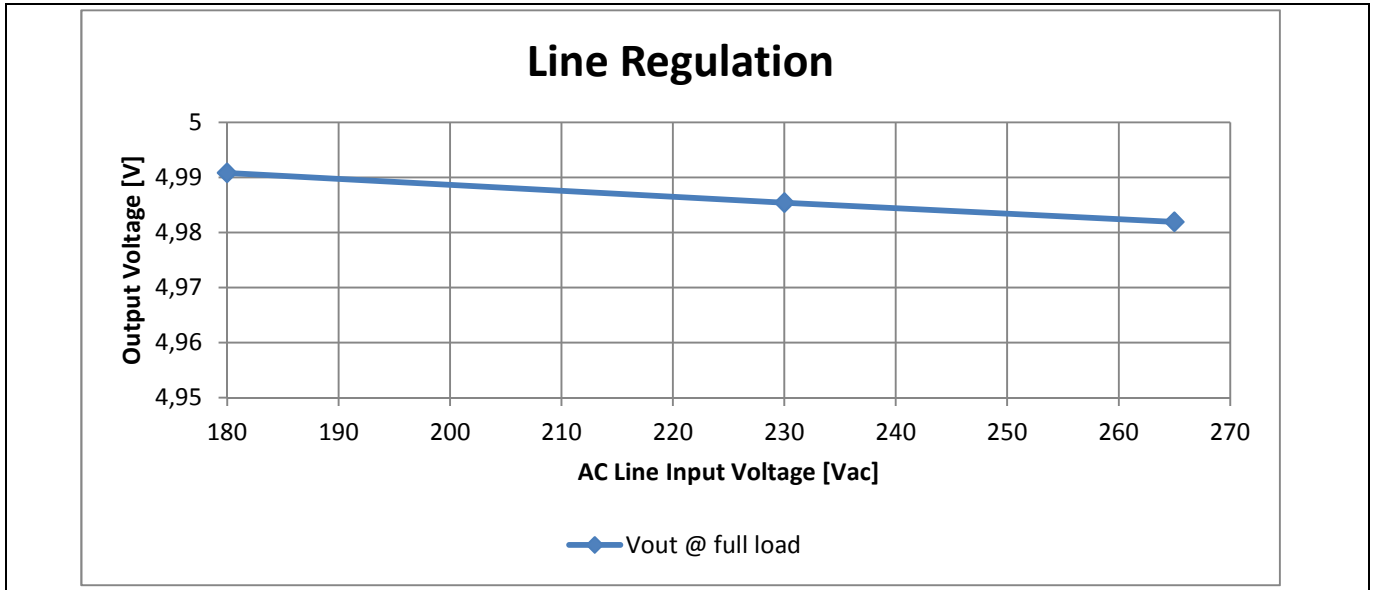

Figure 15 Line regulation at full load

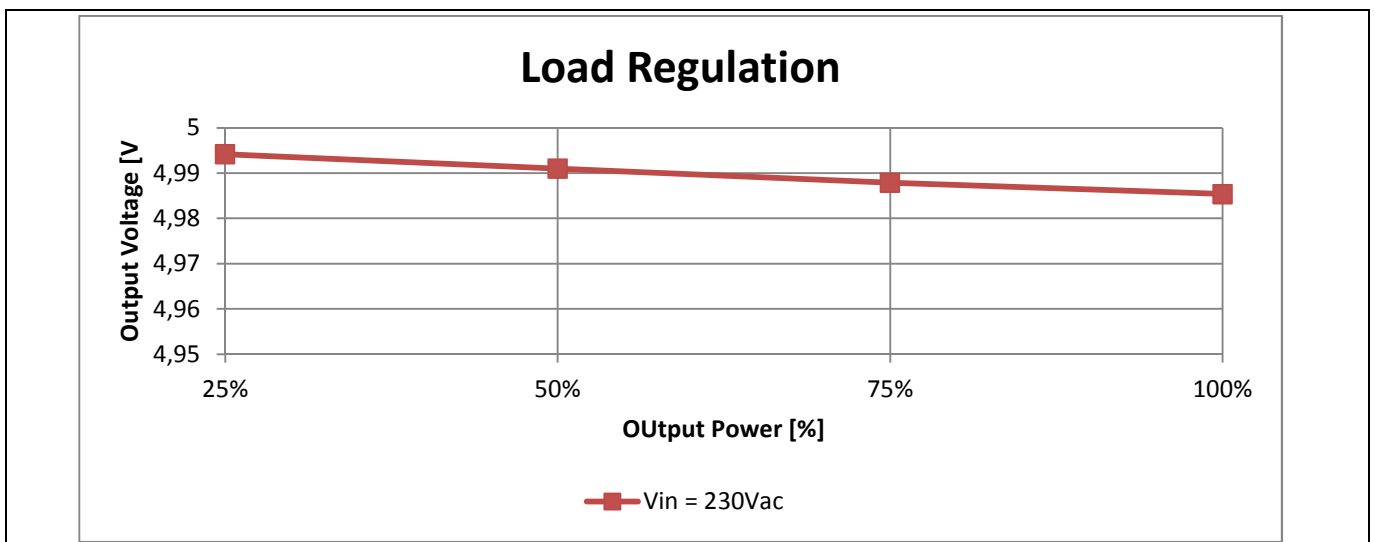

Figure 16 Load regulation at $V_{in}=230 V_{ac}$

Test results

9.5 Output voltage ripple

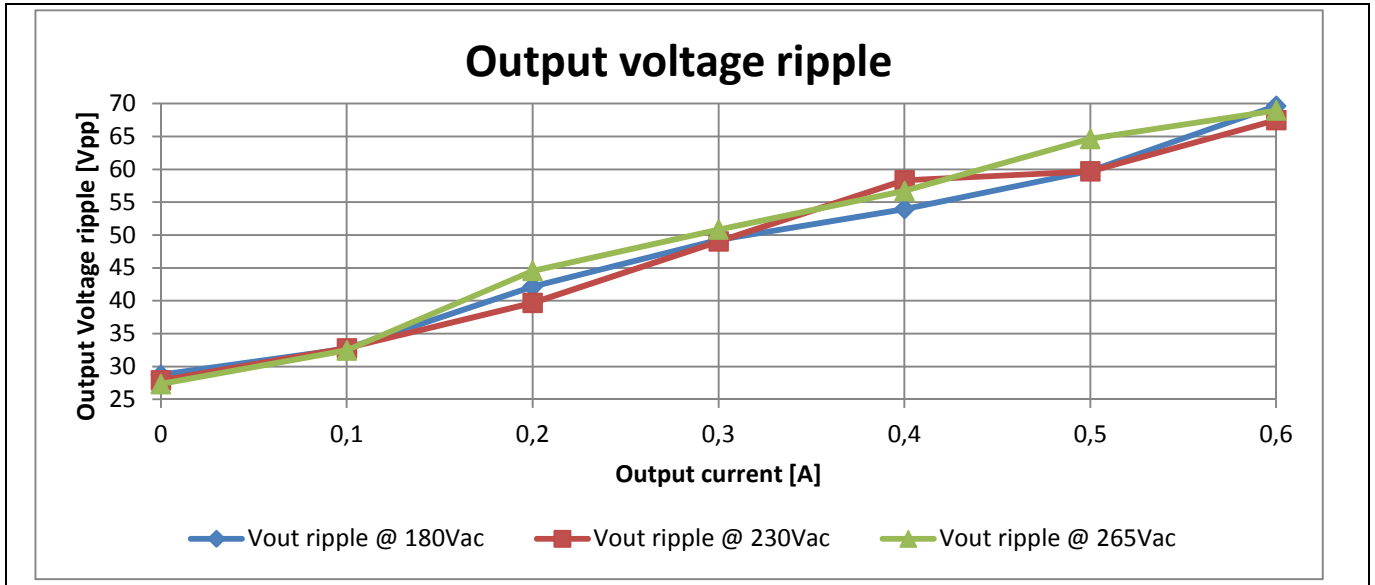

Figure 17 Output voltage ripple

Maximum output voltage ripple is 70 mVpp.

9.6 Thermal performance

The thermal photos were taken with a FLIR T600 thermal camera, after the board ran at full load for 45 minutes.

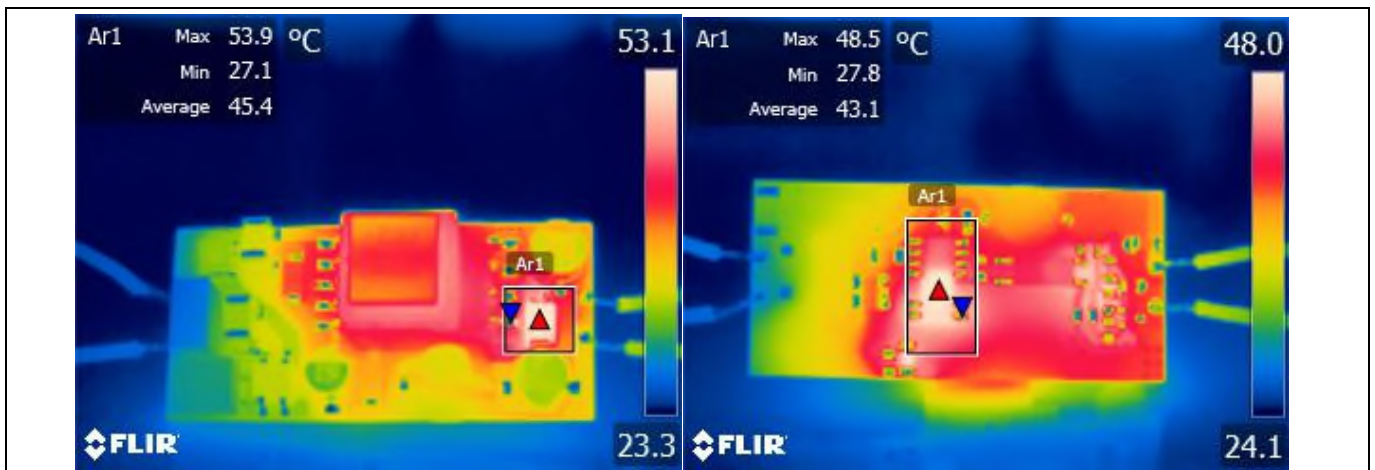

Figure 18 Thermal picture – top and bottom side

The hottest component is the diode D3, with a temperature of 54°C. The controller temperature is 49°C. Ambient temperature is 25°C.

Waveforms

10 Waveforms

10.1 Switching waveforms at steady state

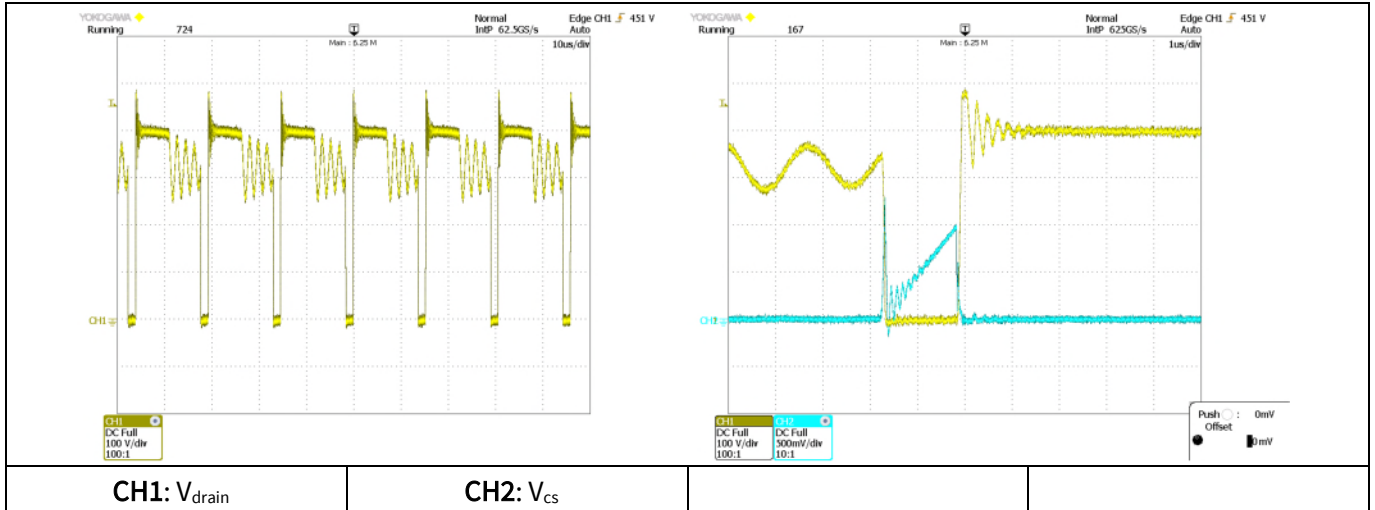

Figure 19 CoolMOS™ drain and source voltage waveforms @230 V_{ac} and full load

10.2 Startup

Startup waveforms are captured @230 V_{ac} and full load (resistive load).

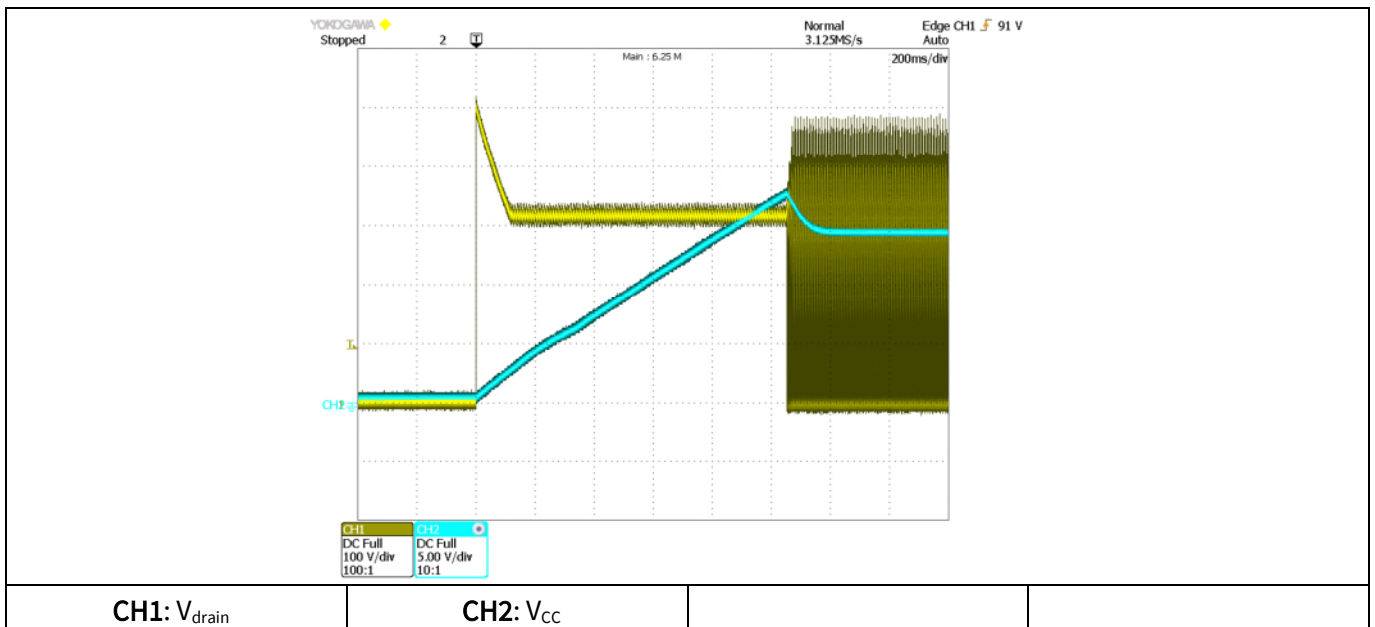

Figure 20 Drain voltage and V_{CC} voltage startup profile

Waveforms

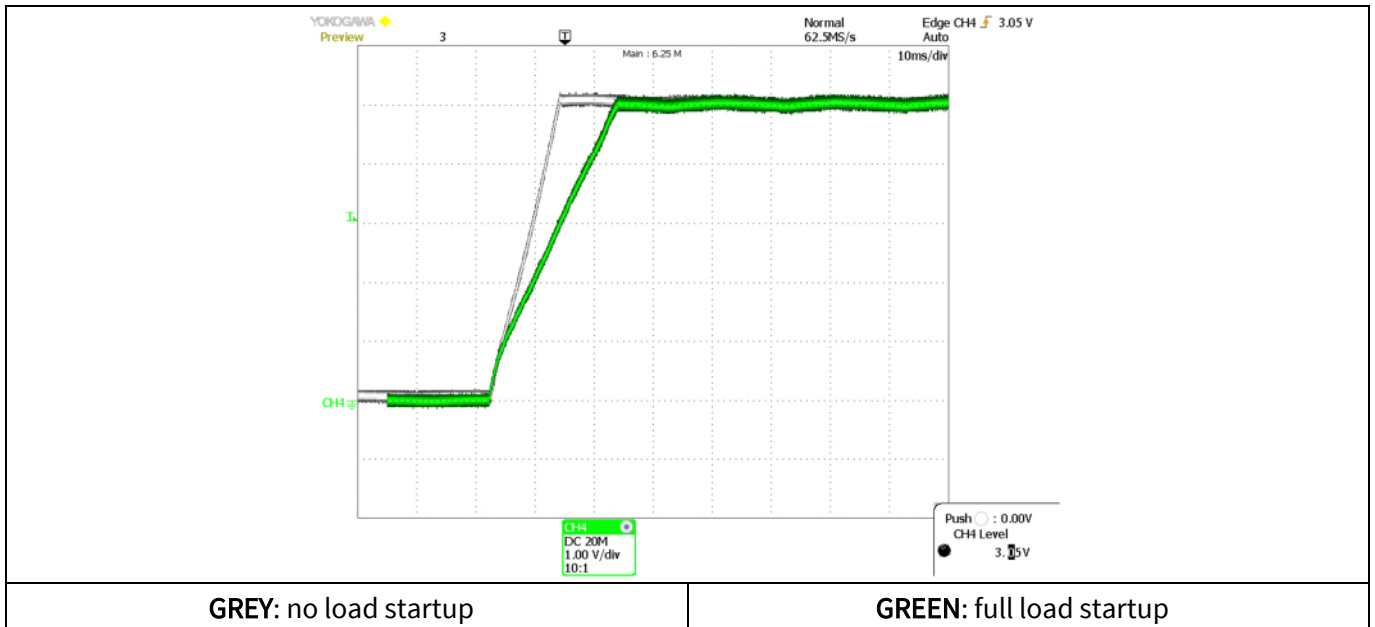

Figure 21 Output voltage startup profile

10.3 Output voltage ripple

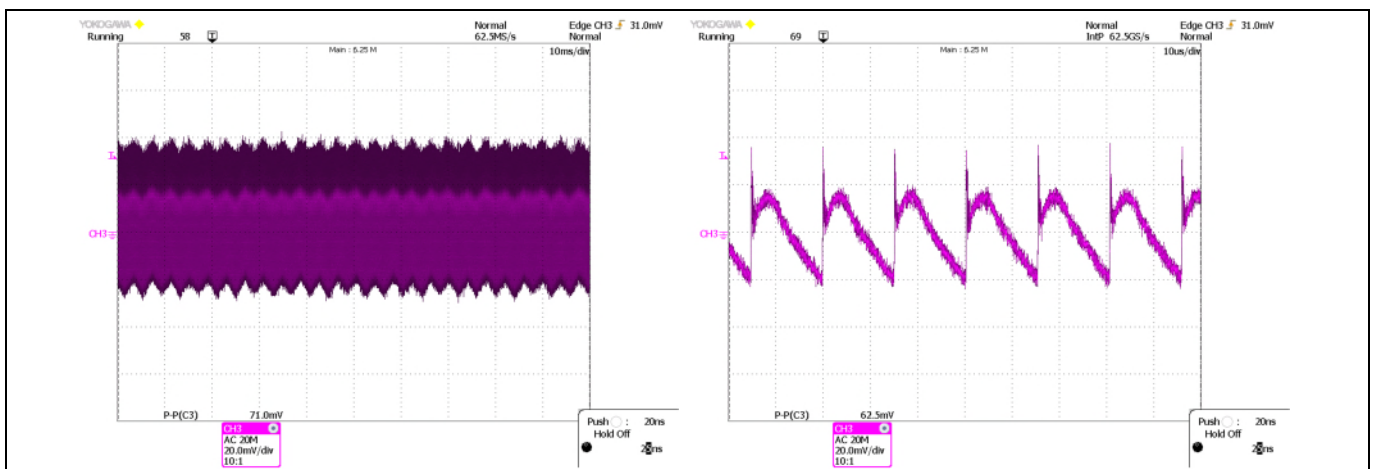

Figure 22 Output voltage ripple @230 V_{ac} and full load

Waveforms

10.4 Active burst mode

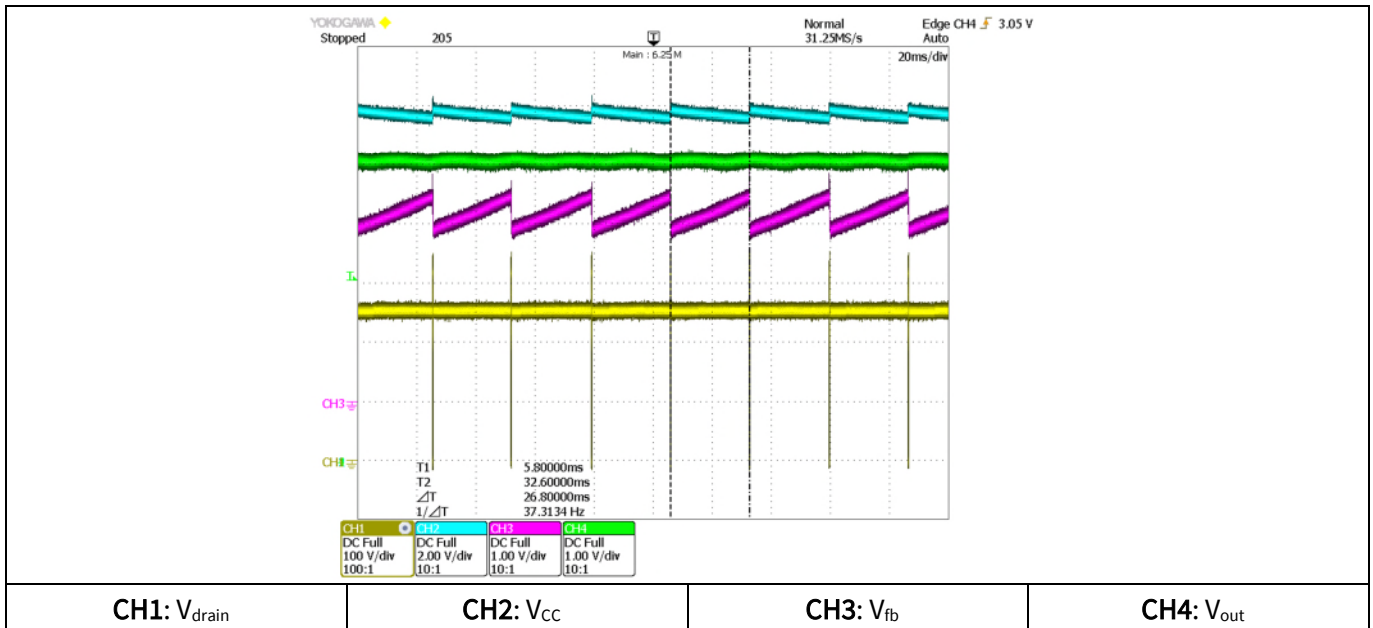

Figure 23 No load active burst mode @180 V_{ac}

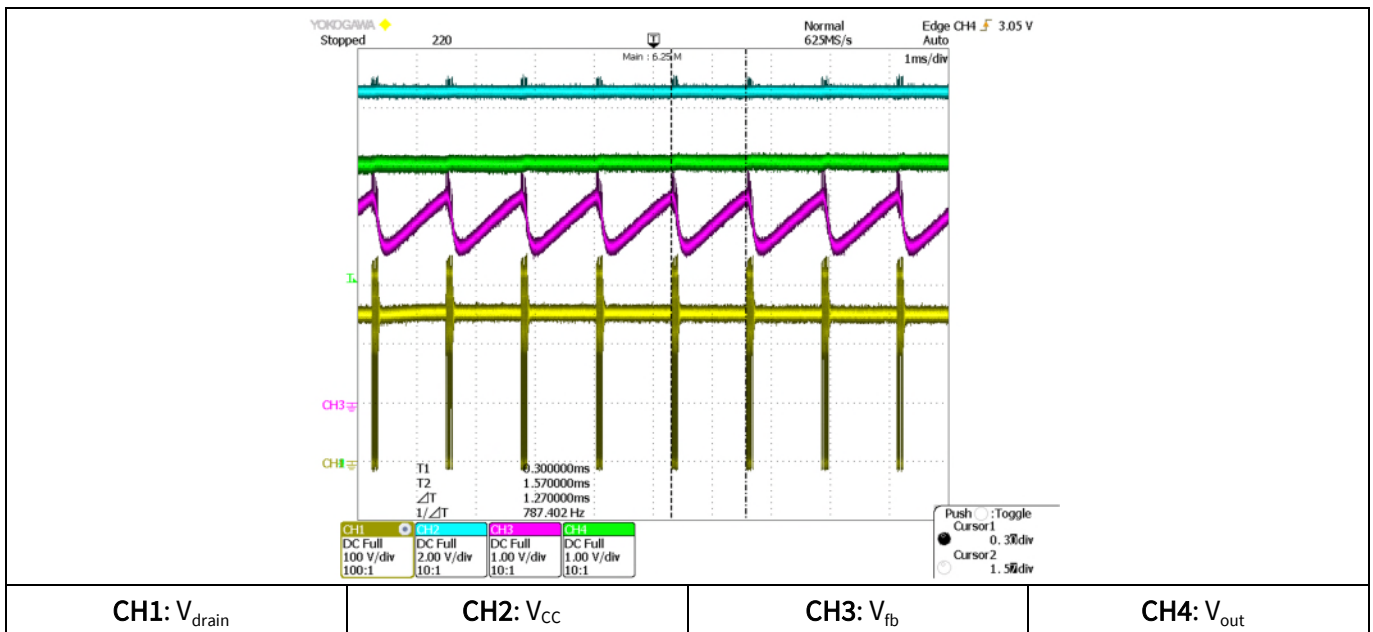

Figure 24 Active burst mode @180 V_{ac} when I_{out}=10 mA

Waveforms

10.5 Load transient response

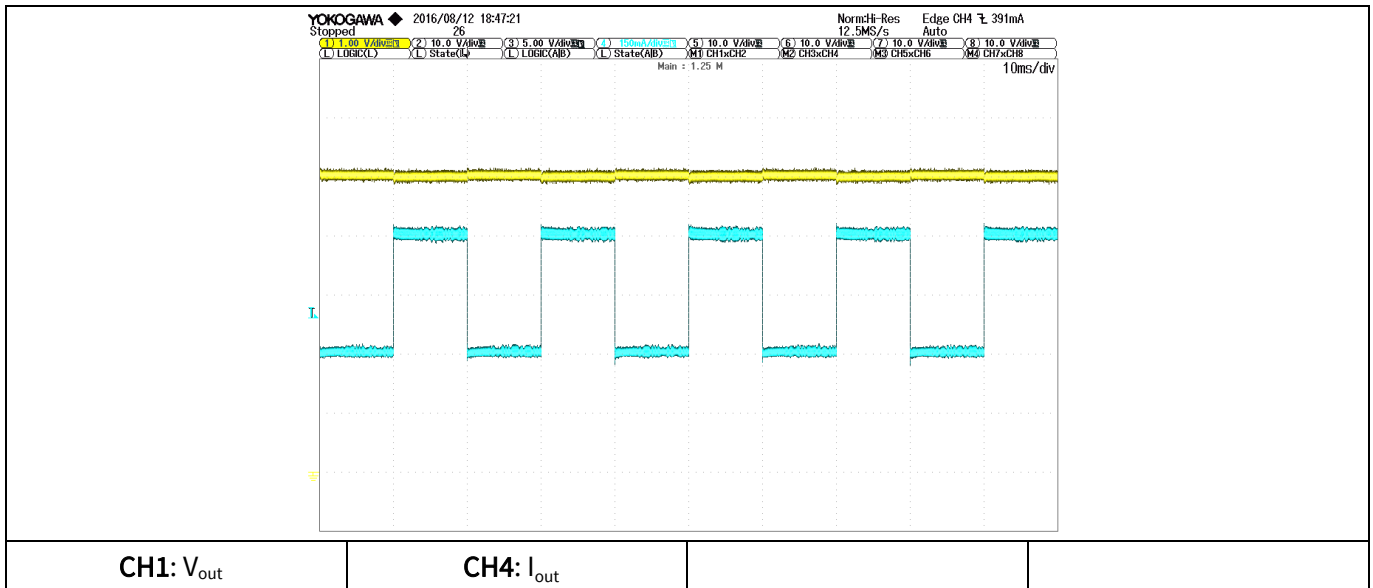

Figure 25 Load transient response

The load is switching between 50% and 100% with a 10 ms period. Slew rate is 0.2 A/μs.

10.6 Output voltage overshoot and undershoot

Test setup: V_{in} 230V_{ac}; E-load: Chroma 63103A, CC mode, slew rate 0.2 A/μs.

Figure 26 shows the V_{out} overshoot and undershoot when the load changes from full load to open load and vice versa. When the full load changes to open load, the V_{out} overshoot is 5.16 V. V_{out} undershoot is 4.81 V when the load jumps from open to full load.

NB: the waveforms in this section were measured with a YOKOGAWA DLM4058 Oscilloscope. Please refer to YOKOGAWA's user manual for the DC accuracy.

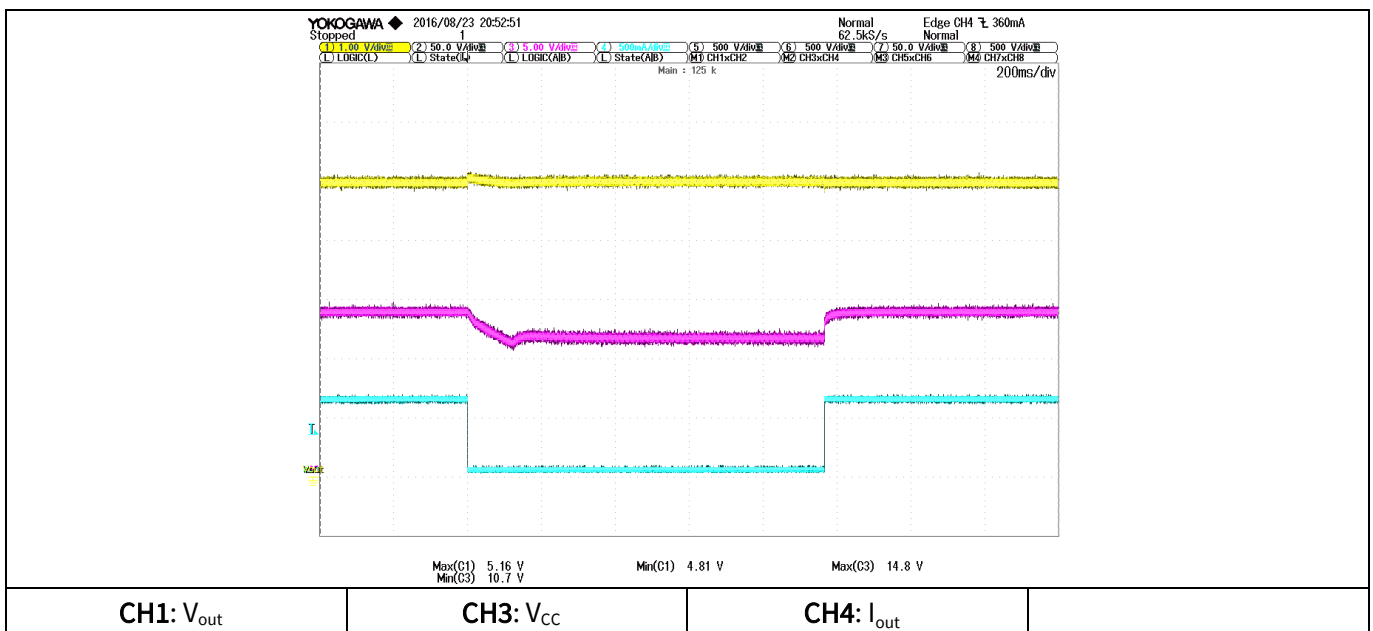

Figure 26 Output voltage overshoot and undershoot due to load transition

Waveforms

Some demo boards may demonstrate V_{out} dual overshoots as shown in Figure 27. The first V_{out} overshoot is due to the load jump from full load to open load. When the first V_{out} overshoot happens, V_{FB} is kept low and there is no PWM switching activity. V_{out} and V_{CC} start discharging. V_{CC} capacitor C7 and output capacitors C9 / C10 are Aluminum electrolytic capacitors with $\pm 20\%$ capacitance tolerance. In extreme case, C7's tolerance is -20% , while both C9 and C10 have tolerance of $+20\%$. V_{CC} discharges (much) faster than V_{out} , so that V_{CC} triggers the UVLO (10.5V) before the IC enters active burst mode. Therefore, the IC enters auto restart. A second V_{out} overshoot happens when V_{CC} is charged up to 18 V and the IC starts switching. The maximum V_{out} is detected at the second overshoot: 5.23V.

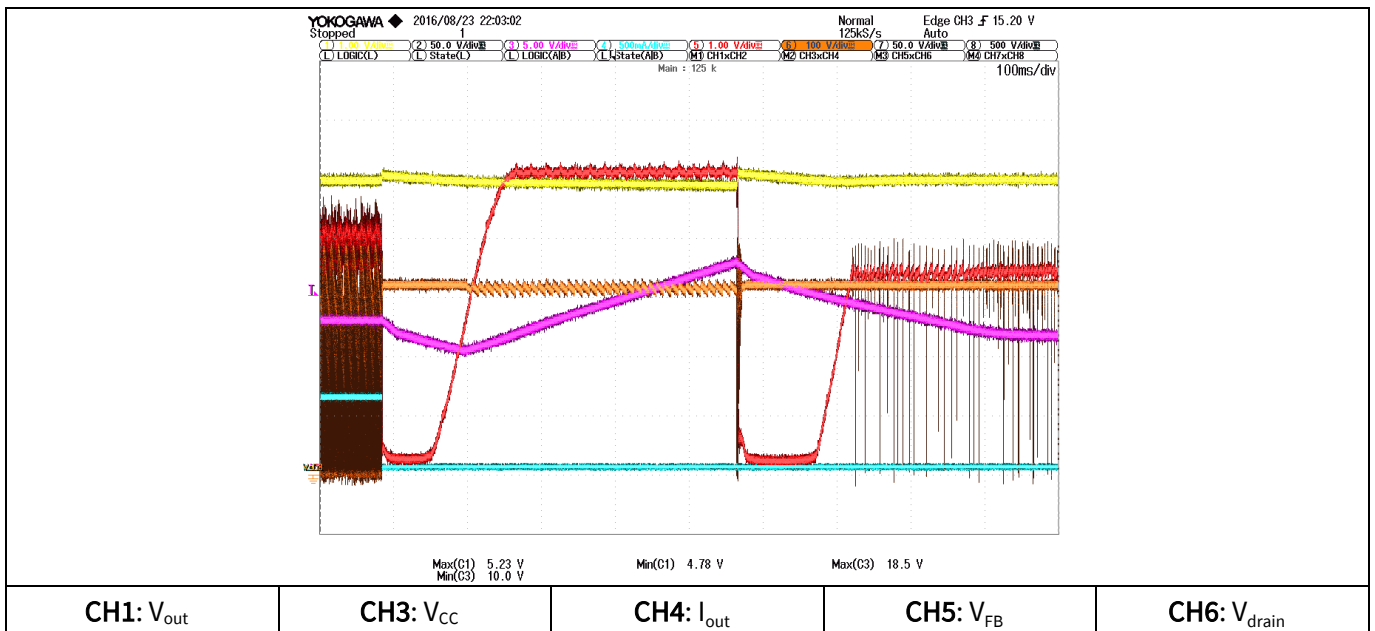
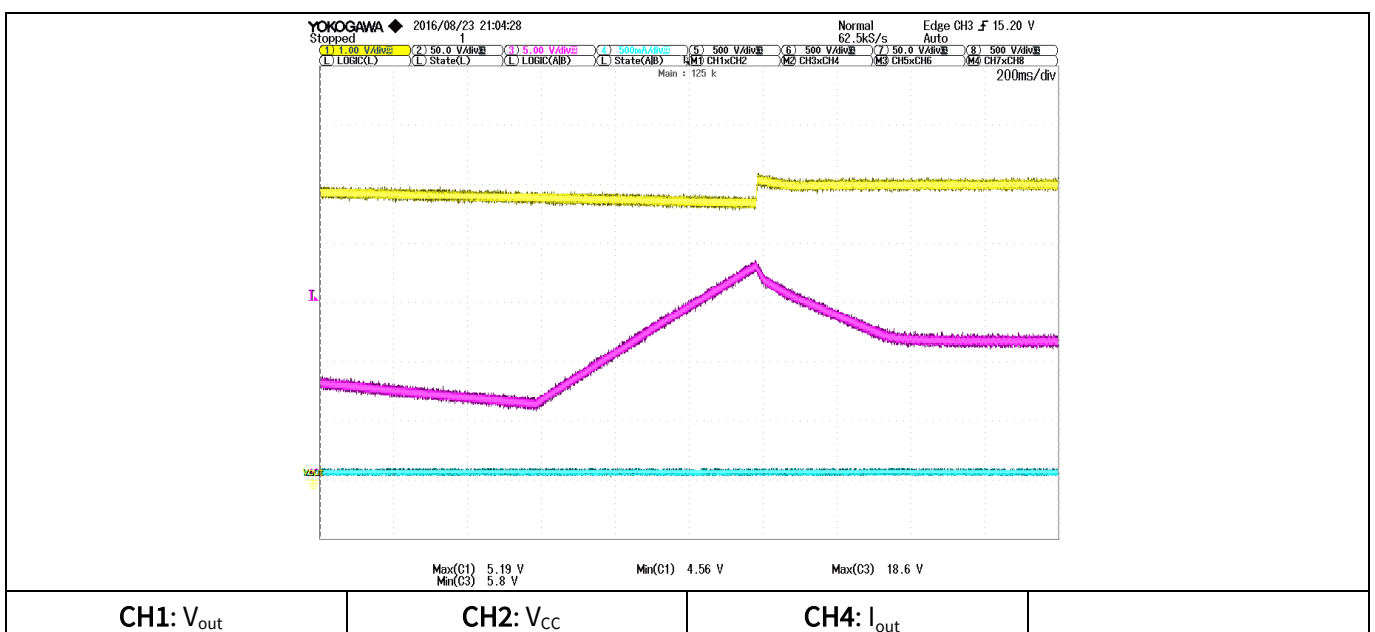

Figure 27 Output voltage dual overshoots due to load transition

Figure 28 and Figure 29 show the output voltage overshoot if a short AC line interruption occurs. With an open load, the overshoot is large as the device restarts and the startup procedure charges the output capacitors which are not yet discharged (CH4 V_{out}). This overshoot can be reduced by making the feedback loop faster, but it will affect the power consumption at no load. V_{out} overshoot level is 5.19 V.



Waveforms

Figure 28 Output voltage overshoot due to AC line voltage interruption (no load)

With a 10 mA load, when the AC source is removed, V_{out} (V_{out}) discharges quickly to a low level. When the AC source is connected again, typically no overshoot was observed at V_{out} .

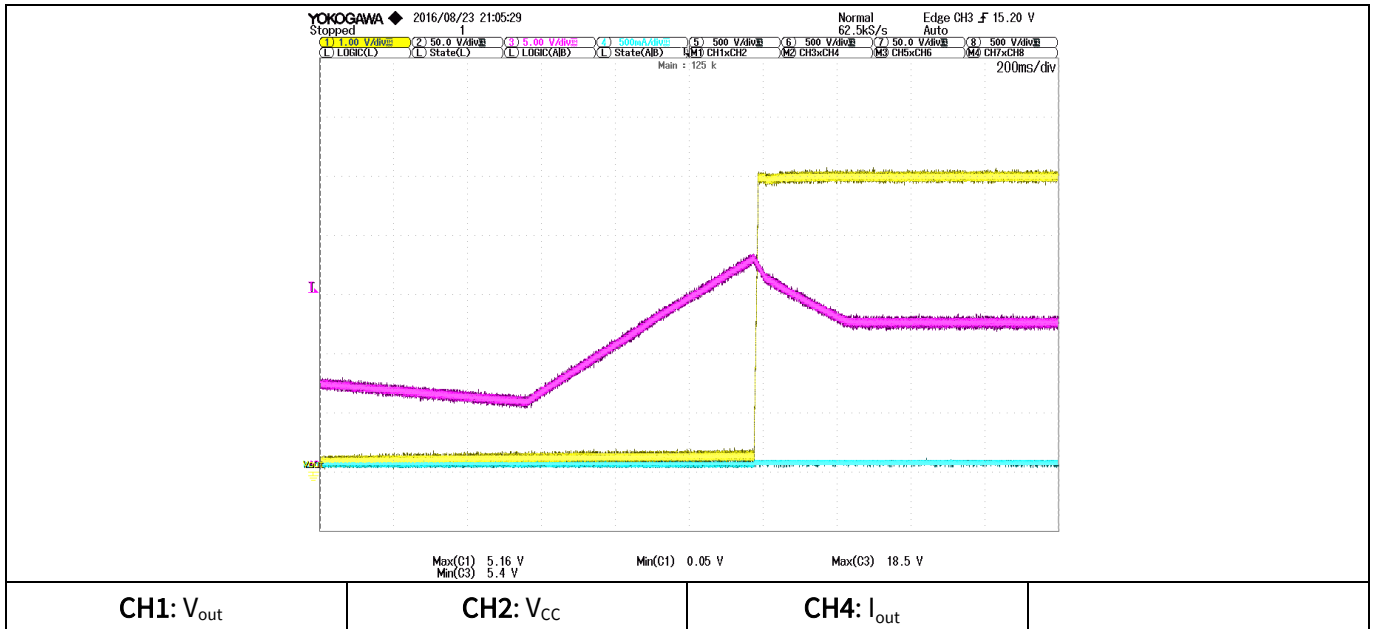

Figure 29 Output voltage overshoot due to AC line voltage interruption ($I_{out}=10$ mA)

Conducted EMI

11 Conducted EMI

Conducted EMI was measured according to test standard EN55022 class B, at $V_{in}=230 V_{ac}$ and full load.

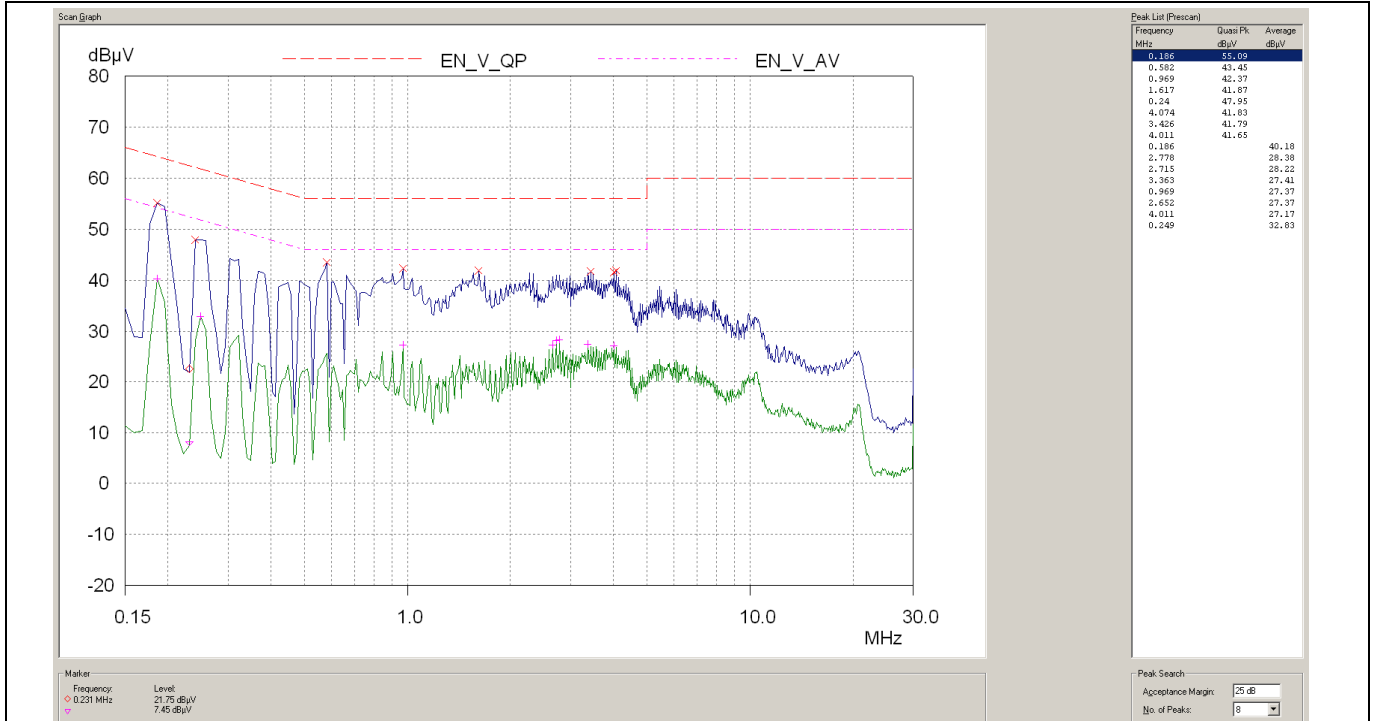

Figure 30 Line

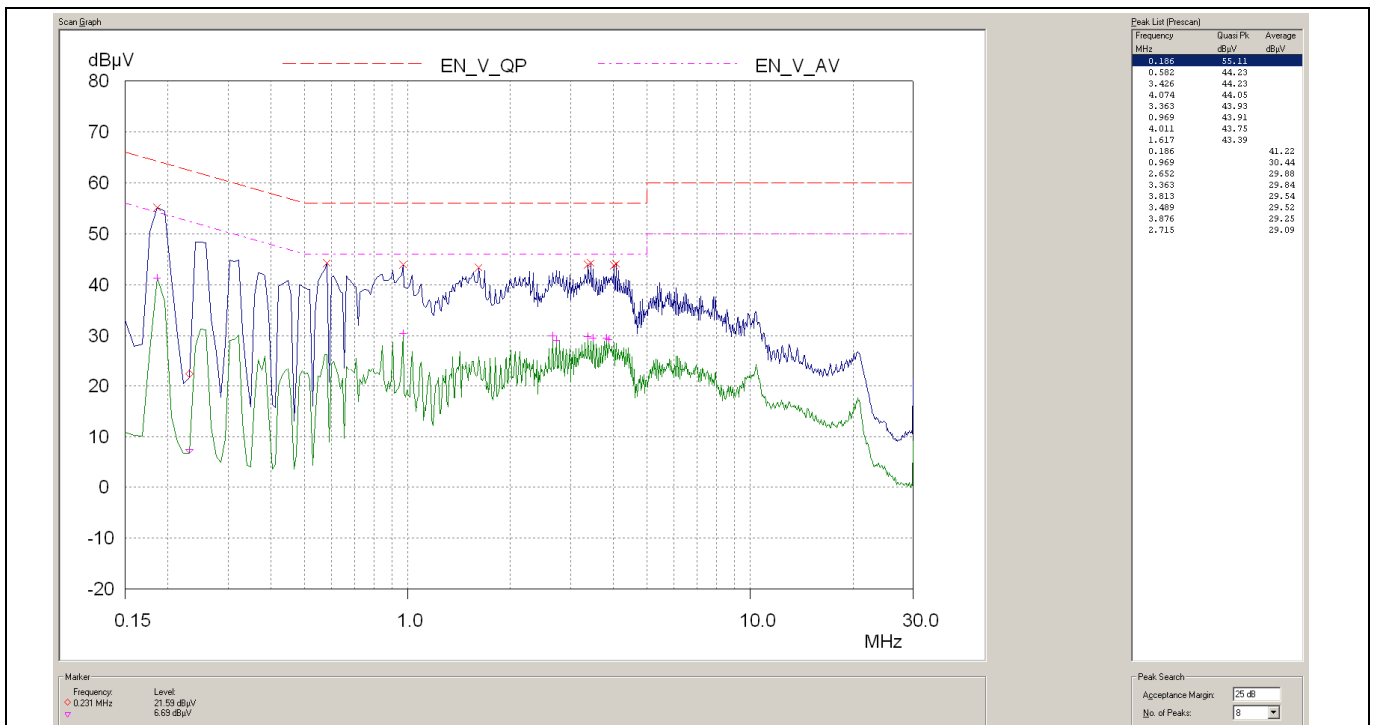

Figure 31 Neutral

12 References

- [1] Infineon Technologies, Datasheet ICE3RBR4765JG “Fixed-Frequency, 650 V CoolSET™ in DS0-12 Package”
- [2] Infineon Technologies, Application Note 10 W 12 V SMPS Evaluation Board with CoolSET®-F3R ICE3BR4765JG

Revision history

Revision history

Major changes since the last revision

Page or Reference	Description of change
	First version

Trademarks of Infineon Technologies AG

μHVIC™, μIPM™, μPFC™, AU-ConvertIR™, AURIX™, C166™, CanPAK™, CIPOS™, CIPURSE™, CoolDP™, CoolGaN™, COOLiR™, CoolMOS™, CoolSET™, CoolSiC™, DAVE™, DI-POL™, DirectFET™, DrBlade™, EasyPIM™, EconoBRIDGE™, EconoDUAL™, EconoPACK™, EconoPIM™, EiceDRIVER™, eupec™, FCOS™, GaNpowIR™, HEXFET™, HITFET™, HybridPACK™, iMOTION™, IRAM™, ISOFACE™, IsoPACK™, LEDrivr™, LITIX™, MIPAQ™, ModSTACK™, my-d™, NovalithIC™, OPTIGA™, OptiMOS™, ORIGA™, PowIRaudio™, PowIRstage™, PrimePACK™, PrimeSTACK™, PROFET™, PRO-SIL™, RASIC™, REAL3™, SmartLEWIS™, SOLID FLASH™, SPOC™, StrongIRFET™, SupIRBuck™, TEMPFET™, TRENCHSTOP™, TriCore™, UHVIC™, XHP™, XMC™

Trademarks updated November 2015

Other Trademarks

All referenced product or service names and trademarks are the property of their respective owners.

Edition 2016-09-26

Published by

Infineon Technologies AG

81726 Munich, Germany

© 2016 Infineon Technologies AG.

All Rights Reserved.

Do you have a question about this document?

Email: erratum@infineon.com

Document reference

AN-REF-3W-IOT-COOLSET

IMPORTANT NOTICE

The information contained in this application note is given as a hint for the implementation of the product only and shall in no event be regarded as a description or warranty of a certain functionality, condition or quality of the product. Before implementation of the product, the recipient of this application note must verify any function and other technical information given herein in the real application. Infineon Technologies hereby disclaims any and all warranties and liabilities of any kind (including without limitation warranties of non-infringement of intellectual property rights of any third party) with respect to any and all information given in this application note.

The data contained in this document is exclusively intended for technically trained staff. It is the responsibility of customer's technical departments to evaluate the suitability of the product for the intended application and the completeness of the product information given in this document with respect to such application.

For further information on the product, technology, delivery terms and conditions and prices please contact your nearest Infineon Technologies office (www.infineon.com).

WARNINGS

Due to technical requirements products may contain dangerous substances. For information on the types in question please contact your nearest Infineon Technologies office.

Except as otherwise explicitly approved by Infineon Technologies in a written document signed by authorized representatives of Infineon Technologies, Infineon Technologies' products may not be used in any applications where a failure of the product or any consequences of the use thereof can reasonably be expected to result in personal injury.