



Storm AXS Access Control Products
are powered by LifeSafety Power, Inc





Table of Contents

Notes and Warnings	iii
Symbol Definitions	iii
Warnings	iii
Regulatory Information	iii
Conventions Used Within this Manual	iii
FlexPower Features	iv
Section 1 – Installation and Operation	1
1.1 Mounting	1
1.2 Jumper / LED / Connector Descriptions	3
1.3 Typical Installation & Wire Routing	6
1.4 Power-Up and Basic System Verification Checklist	7
Section 2 – Troubleshooting and Maintenance	8
2.1 Troubleshooting Table	8
2.1 Troubleshooting Table (continued)	9
2.2 Maintenance Instructions	9
Section 3 – Specifications	10
3.1 Electrical Specifications	10
3.2 Temperature Specifications	12
3.3 Mechanical Specifications	12
3.4 Replacement Parts	13
Appendix 1 – FAI Input Usage	14
Appendix 2 – Tamper Switch Wiring	15
Appendix 3 – Terms and Conditions, Warranty	16
A3.1 TERMS AND CONDITIONS	16
A3.2 PAYMENT TERMS	16
A3.3 REPAIRS	16
A3.4 ADVANCE REPLACEMENTS	16
A3.5 EXCHANGES	16
A3.6 CREDITS	16
A3.7 LIFESAFETY POWER Lifetime Warranty	16
Appendix 4 – User Certificate	17









Notes and Warnings

Symbol Definitions

The following symbols are used throughout this manual

-  This symbol is intended to alert the installer of shock hazards within the enclosure. Service should only be performed by qualified service personnel
-  This symbol is intended to alert the installer of important information intended to help the installer avoid personal injury or property damage

Warnings

-  Installation and service should be performed only by qualified service personnel and should conform to all local codes
-  To reduce the risk of electric shock or fire, do not expose this equipment to rain or moisture
-  This equipment shall be installed in a manner which prevents unintentional operation by employees, cleaning personnel, or others working in the premises, by falling objects, customers, building vibration, or similar causes
-  This equipment is not intended for use within the patient care areas of a Health Care Facility
-  Replace fuses only with the same type and rating as indicated in the specifications section of this manual.
-  To prevent impaired operation, ensure that all wiring is routed and secured to prevent accidental open or short circuit conditions
-  The system and any batteries (if used) should be tested at least once per year to ensure proper operation
-  Batteries (if used) should be maintained at an ambient temperature of between 32 and 120 degrees Fahrenheit (0-49 Celsius) or premature loss of battery power could occur

Regulatory Information

The equipment discussed within this manual has been tested to the following standards:

- UL294, UL603, UL1076
- ULC S318, ULC S319
- CSA C22.2 #107.1

FCC Information

Note: This equipment has been tested and found to comply with the limits for a Class A digital device, pursuant to Part 15 of the FCC Rules. These limits are designed to provide reasonable protection against harmful interference when the equipment is operated in a commercial environment. This equipment generates, uses, and can radiate radio frequency energy and, if not installed and used in accordance with the instruction manual, may cause harmful interference to radio communications. Operation of this equipment in a residential area is likely to cause harmful interference in which case the user will be required to correct the interference at his own expense

Conventions Used Within this Manual

Positional information (e.g. top, bottom, up, down, left, right, etc.) is referenced with the board or enclosure in the orientation shown in the illustrations in this manual

Section 1 – Installation and Operation

The following pages cover the installation, setup, and basic operation of the FPO series power supplies.

1.1 Mounting

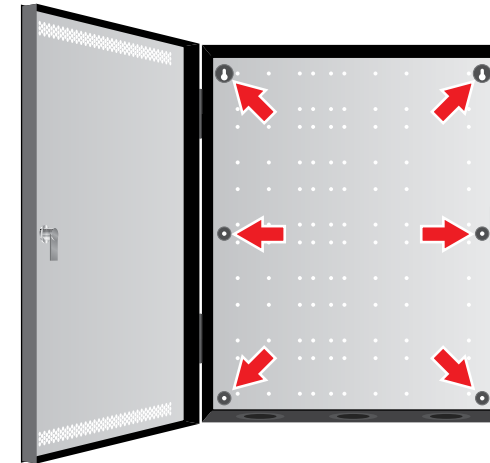

Mounting an Enclosure

Use the following procedure when mounting a LifeSafety Power wall-mount enclosure.

1. (Optional) Remove the enclosure's cover.
2. Locate the top keyhole mounting holes in the back of the enclosure.
3. Mark and pre-drill the locations for the keyholes in the mounting surface.
4. Partially install two fasteners appropriate for the surface on which the enclosure is being installed. Leave the heads of the fasteners approximately 1/4" out from the surface. Minimum fastener size should be #10 or larger.
5. Hang the enclosure on the two fasteners and mark the locations of the four remaining mounting holes.
6. Remove the enclosure and pre-drill the locations for the four remaining mounting holes.
7. Re-hang the enclosure on the top mounting fasteners, start the remaining four fasteners and tighten all fasteners.
8. Reinstall the enclosure's cover, if removed in step 1.

⚠ It is the installer's responsibility to determine the appropriate fastening system for use with the surface the enclosure is being mounted to.

⚠ For UL1076 applications, after installation is complete, the installer must install the two supplied 1" long screws to the edge of the enclosure's cover for additional security.

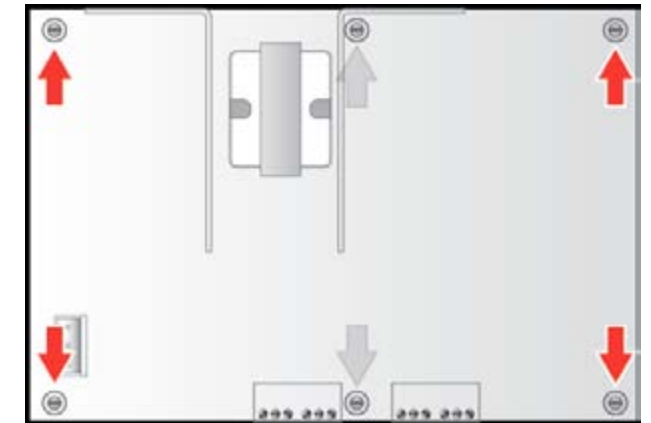

Mounting an FPO Board to an Enclosure

Use the following procedure when mounting an FPO power supply to a LifeSafety Power enclosure.

1. Locate the appropriate mounting holes in the enclosure and snap the four or six standoffs provided into the holes.
2. Align the board mounting holes (mounting hole locations are indicated in the drawing above) with the standoffs and snap the board onto the standoffs. Be sure the board is properly oriented before snapping the board onto the standoffs.

FP075

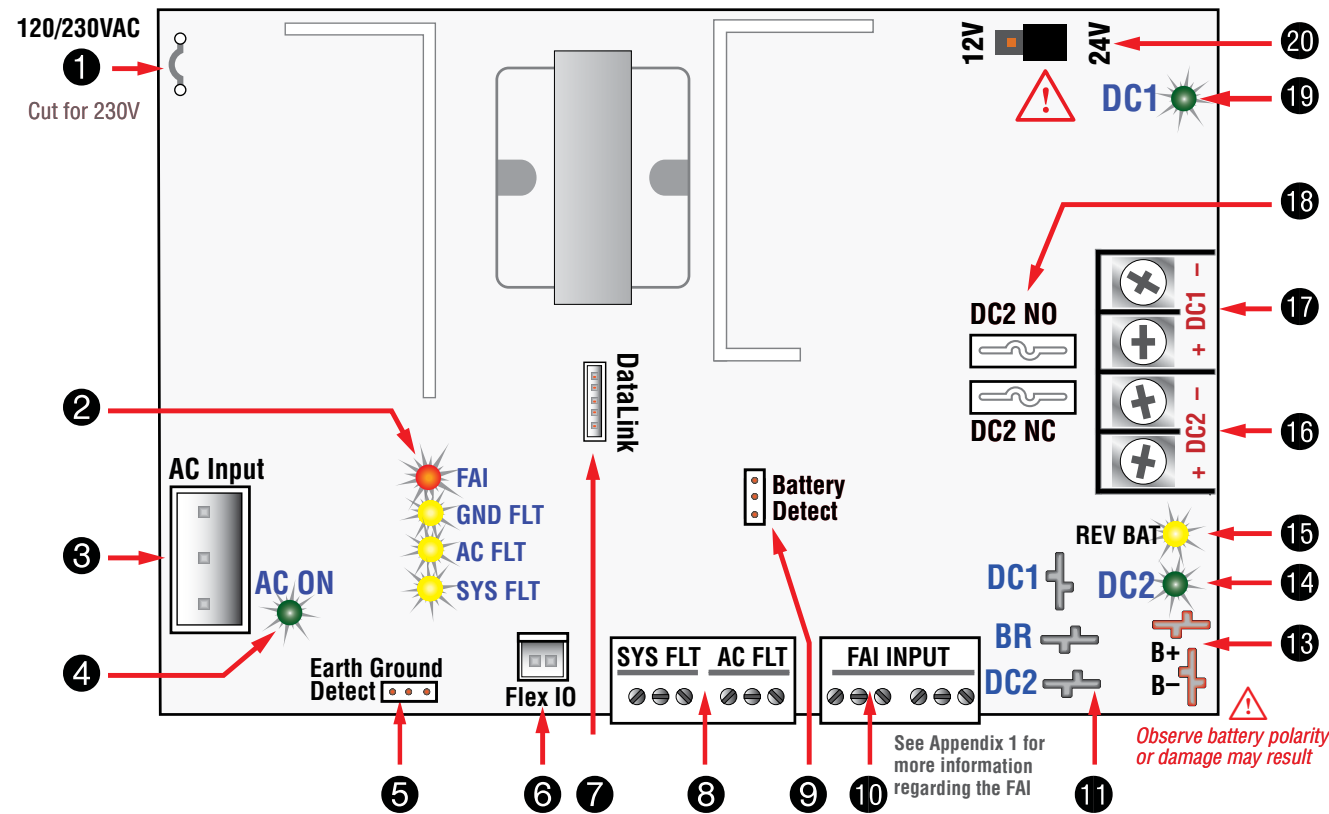

1.2 Jumper / LED / Connector Descriptions

1 AC Input Voltage Selection (JP1)

This jumper configures the FPO for the AC input voltage to be used.

- Leave jumper INTACT for 120V input
- CUT and remove jumper for 230V input

⚠ Failure to cut this jumper when using the FPO with a 230VAC input will result in damage to the system and void the warranty.

2 FAI and Fault LED Status Indicators

FAI (D22) – Red

This LED lights when a valid FAI signal is received on the FAI input terminals.

GND FLT (D42) – Yellow

This LED lights when an impedance is detected between earth ground and any voltage output or DC common.

AC FLT (D43) – Yellow

This LED lights when the AC input voltage is low or missing.

SYS FLT (D33) – Yellow

This LED lights when a system trouble is detected by the FPO. Trouble conditions indicated by the SYS FLT LED include:

- Missing Battery (If BAT DET jumper is ON)
- Earth Ground Fault (If EARTH GND DET jumper is ON)
- Battery voltage out of range
- DC output voltage out of range
- Ruptured fuse
- Accessory Board Fault
- Internal Fault

3 AC Input (J9)

J9 accepts the provided three-wire connector harness for connection to the AC Line. Cut jumper JP1 if powering the FPO with a 230VAC input. Connections are by wire nut as follows:

120VAC

- Green – Earth Ground
- Black – Hot
- White – Neutral

230VAC

- Green – Earth Ground
- Black – Phase 1
- White – Phase 2

⚠ Always connect earth ground first and disconnect last

4 AC ON (D34) – Green

This LED lights when any AC voltage is present on the AC input. It does not indicate that the voltage is sufficient for proper operation of the FPO power supply. See the yellow AC FLT LED for AC voltage out of range indication.

⚠ Always confirm the absence of AC power with a meter before servicing to prevent electric shock.

5 Earth Ground Fault Detection (JP2)

The EARTH GND DET jumper enables or disables Earth Ground (EG) fault detection as follows:

- **Jumper ON** Enable EG Fault Detection
- **Jumper OFF** Disable EG Fault Detection

Earth Ground fault detection detects continuity between earth ground and any voltage output or DC common on the system.

⚠ Only one component of an entire system should be enabled for earth ground detection to avoid conflicts.

6 FlexIO Connection

This connector supplies the fault and FAI status between the FPO power supply and any accessory boards in the system. The appropriate cable is supplied with the accessory boards. See the Accessory Boards section of this manual for more information.

7 DataLink Connection

This is the connector for the DataLink connection. It allows optional programming and monitoring of the FPO power supply via computer or through an optional NL network module.

DataLink cables and the PowerCom software package are available separately from LifeSafety Power for accessing these features.

See the instructions for the PowerCom software for more information.

8 Fault Output Connections (TB3)

These terminals provide the System Fault and AC Fault contact outputs. The terminals are removable and are labeled on the PC board in the non-powered (fault) state. For UL1076 compliance, a tamper switch must be wired in series with the Sys Fault contact output. See Appendix 1 for tamper switch wiring information. These terminals accept AWG14 – AWG22 wire. Fault conditions reported include:

AC FLT

- Low AC
- Missing AC

SYS FLT

- Missing Battery (If BAT DET jumper is ON)
- Earth Ground Fault (If EARTH GND DET jumper is ON)
- Battery voltage out of range
- DC output voltage out of range
- Ruptured fuse
- Accessory Board Fault
- Internal Fault

FP075

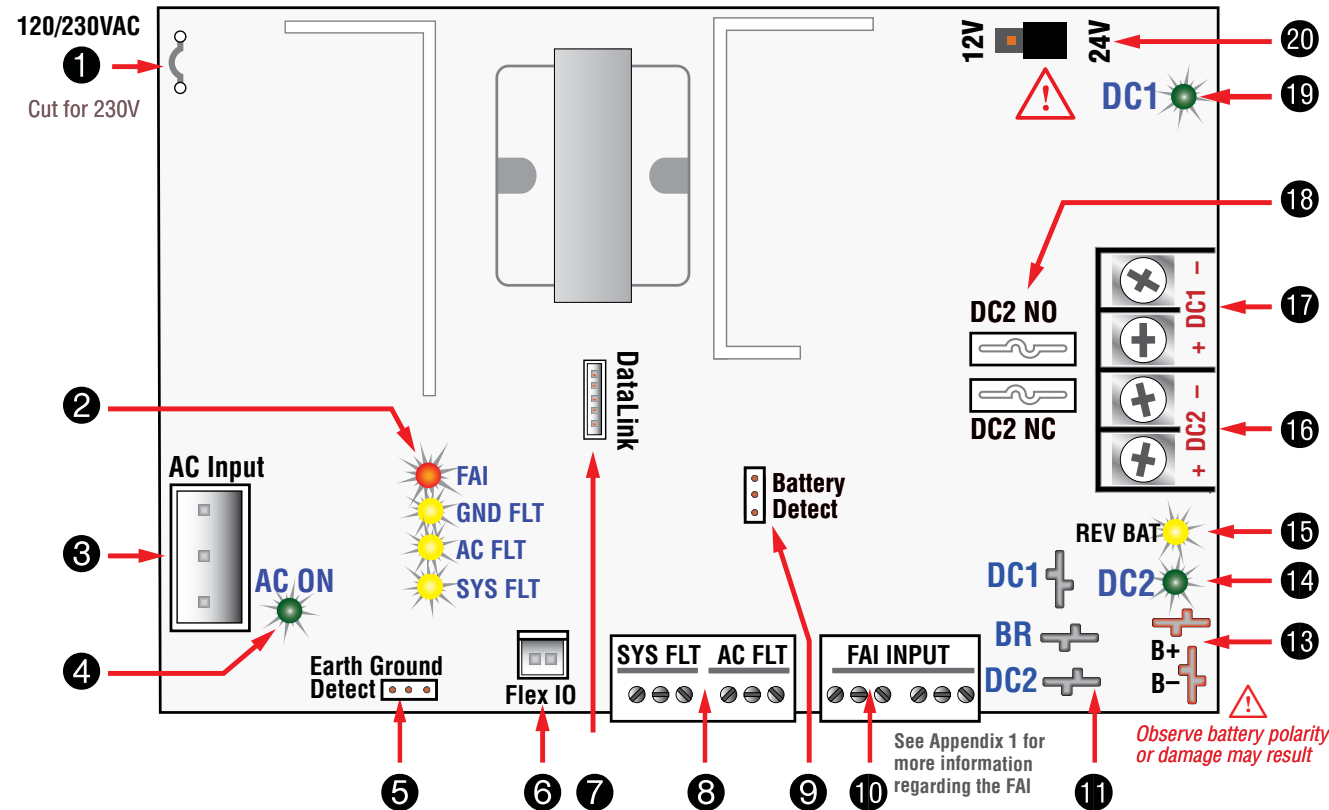

9 Battery Presence Detection (JP3)

The BAT DET jumper enables or disables Battery Presence (BP) fault detection as follows:

- **Jumper ON** Enable BP Fault Detection
- **Jumper OFF** Disable BP Fault Detection

Battery Presence fault detection indicates a fault when the backup battery is disconnected from the FPO power supply. If no backup battery is being used, this jumper should be removed.

10 FAI Input Connections (TB2)

These terminals accept the optional FAI / Access Control input for controlling the DC2 output and any FAI capable accessory boards connected to the FPO power supply. The terminals are removable and are labeled on the PC board. These terminals accept AWG14 – AWG22 wire. See Appendix 1 - FAI Input Usage for more information. Connections are as follows:

- **I+ & I- Terminals** These terminals are the input terminals for the FAI Input. The FAI input is activated when a voltage between 9 and 30 volts is applied across these terminals in the correct polarity. See Appendix 1 - FAI Input Usage for more information.
- **V+ & V- Terminals** These terminals are a low-current auxiliary voltage output which can be used with a dry contact or open collector for activating the FAI Input's I+ and I- terminals.
- **L Terminals** Latch Reset contact input. If a latching FAI Input is desired, a normally closed contact is placed across these terminals. When the FAI Input is activated, it will latch in the activated state until this contact is momentarily opened. **If the latching feature is not desired, leave these terminals open.**

11 FlexConnect Power Connections

Faston connectors for the power connection to any accessory boards to be connected. Pre-terminated power leads are provided with the accessory boards. See the Accessory Boards section of this manual for more information. Connections are as follows:

- **DC1** This faston provides a constant voltage output for connection to the accessory boards.
- **BR** The DC Common (DC Ground) for the FPO power supply.
- **DC2** This faston provides an FAI controlled output that operates in conjunction with the DC2 output terminals. This connection is typically only used in single voltage systems with D8 accessory boards.

12 NL1/NL4 Power Connection (V+ & V-)

Faston connectors for powering an NL1 or NL4 board. See the NL1 or NL4 manual for more information.

13 Battery Connection (BAT+ & BAT-)

Faston connectors for connection of the backup battery set. Pre-terminated battery leads are provided. See the Specifications section for the maximum battery size. If no battery set is to be used, ensure the BAT DET jumper is off to prevent a fault condition from being annunciated.

⚠ Note that FPO5 PCB's and FPO100-250 PCB's have different battery connection layouts.

⚠ Observe polarity or damage to the system will occur.

⚠ It is the installer's responsibility to determine the proper battery size for the installation. See the Specifications section for standby current requirements.

14 DC2 (D5) – Green

This LED lights when voltage is available on the DC2 output terminals. This LED will extinguish if the output is disabled via the FAI input.

15 REV BAT (D20) – Yellow

This LED lights if the backup battery set is connected in the reverse polarity. The lighting of this LED will also be accompanied by the rupture of the battery fuse (F4).

16 DC2 Output (TB1)

The DC2 output may optionally be controlled by the FAI input. The full current of the FPO is available on these terminals. If not using the FAI input, the DC2 fuse should be inserted into the NC fuseholder to allow the DC2 output to provide continuous power. See the sections on the FAI Input and DC2 Fuse for more information. These terminals accept AWG12 – AWG18 wire.

⚠ When powering magnetic loads such as maglocks, door strikes, solenoids, etc, each of these loads must have a reverse protection diode either built-in or external to the device.

17 DC1 Output (TB1)

The main DC output of the FPO power supply. The full current of the FPO is available on these terminals at all times and is unaffected by the FAI input. These terminals accept AWG12 – AWG18 wire.

⚠ When powering magnetic loads such as maglocks, door strikes, solenoids, etc, each of these loads must have a reverse protection diode either built-in or external to the device.

18 DC2 Output Configuration (F2 & F3)

By selecting the appropriate fuse holder for the DC2 fuse, the fail-safe or fail-secure operation of the DC2 output can be selected.

- **DC2+ NO (F2)** – the DC2 output will energize when an FAI signal is received on the FAI input.
- **DC2+ NC (F3)** – the DC2 output will de-energize when an FAI signal is received on the FAI input.

If the FAI input is not used in the installation, placing the DC fuse in the DC2+ NC fuseholder will allow the DC2 output to be used as a second power output. Do not install fuses into both fuse holders simultaneously.

19 DC1 (D4) – Green

This LED lights when voltage is available on the DC1 output terminals.

20 Output Voltage Selection (SW1)

This switch selects the output voltage of the FPO power supply. The voltage settings are labeled on the PC board as follows:

- **12** 12VDC nominal out
- **24** 24VDC nominal out

⚠ Remove power before changing output voltage or damage to the power supply could occur.

1.3 Typical Installation & Wire Routing

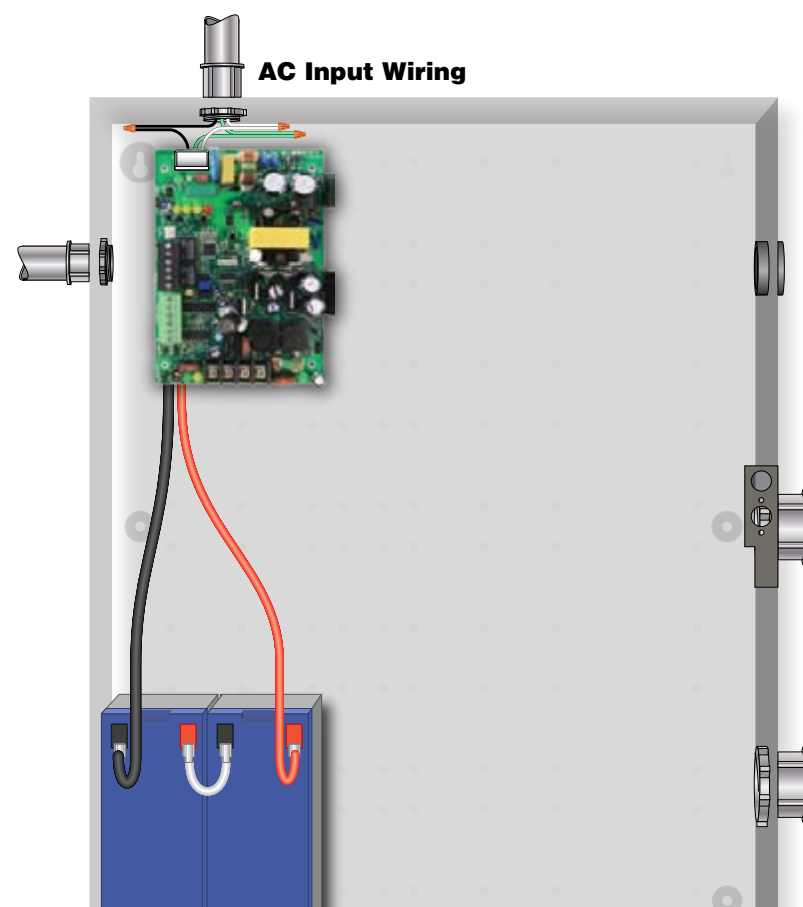

The drawing above shows a typical installation. Actual configuration and wire routing will vary based on the components installed in your system. The following guidelines should be followed for installation.

- Class 2 Power limited wiring must be separated from non-power limited wiring by a minimum of 1/4 inch and must use separate knockouts
- The installation and all wiring methods shall be in accordance with ANSI/NFPA70 and all local codes.
- The installation and all wiring methods shall be in accordance with ANSI/NFPA70 and all local codes. For ULC compliance, installation and all wiring methods shall be in accordance with the Canadian Electrical Code, C22.1, Part I, Section 32

- **For Canadian Installations** - For permanently connected equipment, a readily accessible disconnect device shall be incorporated external to the equipment. Output circuits not connected to removable terminal strips shall also utilize a readily accessible disconnect device
- Any wiring passing through knockouts in the bottom or top surfaces of the enclosure must be enclosed in rigid or flexible metal conduit

1.4 Power-Up and Basic System Verification Checklist

- 1. Ensure proper configuration of all jumpers and switches.
- 2. Apply AC power to the FPO power supply.
- 3. Ensure the Green "AC ON" and "DC1" LEDs are lit. The "DC2" LED may also be lit, depending on the position of the DC2 fuse.
- 4. Verify DC1 output voltage with a meter.
 - a. If set for the 12V nominal setting, the voltage should be approximately 12.5VDC
 - b. If set for the 24V nominal setting, the voltage should be approximately 25.0VDC
- 5. Connect battery, if required for the installation.
- 6. Verify that no yellow LEDs are lit on the FPO power supply.
- 7. If used, activate the FAI input and verify that the red "FAI" LED lights and that the DC2 output switches states. Deactivate the FAI input (and reset the input if configured for latching) and verify that the red FAI LED extinguishes and the DC2 output returns to normal.
- 8. If the battery presence jumper is enabled, remove one lead from the battery – verify that the yellow "SYS FLT" LED lights. Reconnect the battery and the "SYS FLT" LED should extinguish.
- 9. If the Earth Ground jumper is enabled, connect a wire from the ground stud on the enclosure to the DC1+ terminal – the "GND FLT" and "SYS FLT" LEDs should light. Remove the wire and the "GND FLT" and "SYS FLT" LEDs should extinguish. Repeat for the DC1- terminal.
- 10. When a standby battery set is used, remove AC power from the FPO power supply. Verify that the "DC1" LED remains lit and that the "AC FLT" LED lights. Reconnect AC power and verify that the "AC FLT" extinguishes.

Section 2 – Troubleshooting and Maintenance

2.1 Troubleshooting Table

Symptom	Possible Problem	Information / Possible Solution
SYS FLT LED lit and SYS FLT relay indicating a trouble condition	Battery Disconnected	<ul style="list-style-type: none"> Verify that the battery is connected to the FPO. Check all crimp connections on the battery leads Verify that the battery set being used is charged and in good condition If no battery will be used in the installation, remove the BAT DET jumper
	Earth Ground Fault	<ul style="list-style-type: none"> This fault will only display if the EARTH GND DET jumper is ON and will be accompanied by the GND FLT LED being lit An impedance exists between earth ground and a voltage output or DC Common connection on the FPO power supply, an accessory board, or any connected piece of equipment. Isolate the connection with the impedance by removing wires one at a time until the fault clears Ensure that no other equipment in the system is set to detect earth ground faults (including other FPO power supplies in the system). Enabling earth ground detection on more than one piece of equipment in a system will cause a conflict and may cause one or all pieces of equipment in the system to display an earth ground fault
	Low Battery Voltage	<ul style="list-style-type: none"> Battery discharged or damaged– Allow the battery to charge or replace the battery
	High Battery Voltage	<ul style="list-style-type: none"> Incorrect battery set– Ensure the battery set is configured properly for the output voltage setting Problem with battery charging circuit– Contact LifeSafety Power
	High or Low Output Voltage	<ul style="list-style-type: none"> Measure the output voltage at the DC1 terminals. The voltage should be 12.50V for the 12V setting or 25.00V for the 24V setting (±10%). Contact LifeSafety Power if the voltage is outside of this range
	Blown Fuse	<ul style="list-style-type: none"> Check the DC1 and Battery fuses. Verify the integrity of the output wiring and powered devices before replacing any ruptured fuses. Replace fuses only with the same type and rating
AC FLT LED lit and AC FLT relay indicating a trouble condition	Internal Problem	<ul style="list-style-type: none"> Contact Lifesafety Power
	Primary AC Voltage Low or Missing	<ul style="list-style-type: none"> Verify that the AC input voltage is 120V or 230V (±15%) with a meter. For safety, the green AC ON LED indicates the presence of any AC voltage on the input, but not the integrity of the voltage
	120/230 Jumper (JP1) Set Incorrectly	<ul style="list-style-type: none"> Verify that JP1 is set correctly– intact for 120V input, cut for 230V input
DC1 LED Extinguished	Internal problem	<ul style="list-style-type: none"> Contact LifeSafety Power
	Blown DC1 Fuse	<ul style="list-style-type: none"> Check fuse Verify the integrity of the output wiring and powered devices before replacing any ruptured fuses. Replace fuses only with the same type and rating
DC1 LED Extinguished	Power Supply Shut Down	<ul style="list-style-type: none"> Verify DC output voltage, AC power, and backup battery voltage (if used) Check output load integrity and current draw If the FPO detects ten output faults within one minute, the supply will shut down, transfer to battery backup (if available), and generate a fault condition. Cycle AC power to reset the supply after determining the cause of the output fault condition

2.1 Troubleshooting Table (continued)

Symptom	Possible Problem	Information / Possible Solution
DC2 LED Extinguished	Blown DC2 Fuse	<ul style="list-style-type: none"> Check fuse Verify the integrity of the output wiring and powered devices before replacing any ruptured fuses. Replace fuses only with the same type and rating
	Output disabled due to FAI	<ul style="list-style-type: none"> If the DC2 fuse is in the DC2+ NC fuseholder, the DC2 output will be disabled upon receipt of an FAI input, causing the DC2 LED to extinguish If the DC2 fuse is in the DC2+ NO fuseholder, the DC2 output will be disabled and the DC2 LED will be extinguished until receipt of an FAI input
REV BAT LED lit	Battery connection reversed	<ul style="list-style-type: none"> Check the polarity of the battery connections at both ends of the battery harness
AC ON LED Extinguished	Missing or extremely low AC Input	<ul style="list-style-type: none"> Verify that the AC input voltage is 120V or 230V (±15%) with a meter
	Blown AC Fuse	<ul style="list-style-type: none"> The FPO power supply's AC input fuse is non-replaceable, as rupture of this fuse indicates a major malfunction within the FPO supply. Contact Life-Safety Power
Missing Battery Not Detected	Improper setting of BAT DET Jumper	<ul style="list-style-type: none"> The BAT DET jumper must be ON to detect a missing battery
Earth Ground Fault Not Detected	Improper Setting of EARTH GND DET jumper	<ul style="list-style-type: none"> The EARTH GND DET jumper must be ON to detect an earth ground fault
	Another device in the system has earth ground detection enabled	<ul style="list-style-type: none"> Only one device in the system can have earth ground fault detection enabled or conflicts will occur

2.2 Maintenance Instructions

The following are the maintenance instructions for the FPO Series power supply system

- Disconnect AC power prior to servicing
- Verify that there are no fault conditions displayed on any of the yellow fault LEDs as indicated in this instruction manual
- Verify the integrity of all fuses and replace as necessary using the fuse ratings supplied in the Specifications section of this manual
- The battery set (if used) should be checked and replaced if found to be defective or if more than 4 years old (or as required by local code)
- Verify that all output voltages are within range as specified in the Specifications section of this document

Section 3 – Specifications

3.1 Electrical Specifications

FPO Power Supplies

Specifications	FP075	
AC Input	Voltage	120VAC or 230VAC ±15% at 50-60Hz
	Current	1.6A
Standby	Current	100mA
Rated Current for UL603 Proprietary Alarm Installations	Current	1.25A maximum from all circuits in system
DC Output at 12V Setting	Voltage	11.3 -12.0V
	Max Current	4.5A, Nominal Supervisory, 6A Alarm
	Ripple	120mV
	Regulation	±2%
	Efficiency	85% (120VAC 60Hz In, Full Load, No Batt)
DC Output at 24V Setting	Voltage	25.0V ±0.5V nominal
	Max Current	3A
	Ripple	120mV
	Regulation	±2%
	Efficiency	85% (120VAC 60Hz In, Full Load, No Batt)
Battery	Size & Type	4-40AH Lead Acid or Gel Cell
	Charge Current	1A (±10%) Maximum (Adjustable via PowerCom Software)
Fuse Ratings	DC1	ATM 7.5A
	DC2	ATM 7.5A
	Battery	ATM 7.5A
BTU Output	BTU	33
Fault Setpoints	Low AC	95V (±6%)
	Earth GND	2000 Ohms
	Output Voltage	±10% of nominal
	Batt Voltage	±10% of nominal
	Batt Presence	6–15V (12V Setting), 11–29V (24V Setting)
Fault Relay Contacts	AC FLT	1A at 24VDC
	SYS FLT	1A at 24VDC

3.2 Temperature Specifications

Ambient Temperature	0°C to 49°C (32°F to 120°F)
Ambient Humidity	93% at 32°C (90°F) maximum
Storage Temperature	-30°C to 70°C (-22°F to 158°F)

3.3 Mechanical Specifications

Visit www.lifesafetypower.com for AutoCAD files.

FP075

Size	6.00" L x 4.00" W x 2.00" H (152mm L x 102mm W x 51mm H)
Approximate Weight	0.75 lbs. (0.340 kg)

Appendix 1 – FAI Input Usage

This section provides more detailed information on the connection and usage of the FAI input.

Activation with a Normally Open Relay Contact

FAI Activates when the NO contact CLOSES.

FAI Deactivates when the NO contact OPENS.

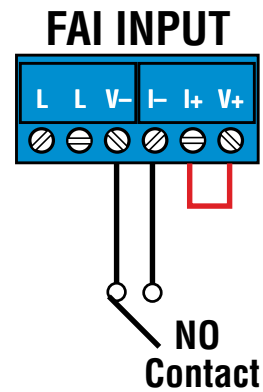

Latching the FAI Input

Latching of the FAI Input is achieved by placing a NC contact across the two 'L' terminals. The FAI may be activated by any of the methods listed. FAI Deactivates when the input is deactivated AND the NC Latching contact is momentarily OPENED.

Example – NO Contact activation with latching

FAI Activates when the NO contact CLOSES. FAI Deactivates when the NO contact OPENS AND the NC contact momentarily OPENS.

FAI Activation with a Normally Open Relay Contact and FPO AC Fault Lock Over Ride

FAI Activates either, when the Fire Alarm NO contact CLOSES, **or** when the AC Fault NC contact CLOSES

FAI Deactivates either, when the Fire Alarm NO contact OPENS, **or** when the FPO AC Fault NC contact OPENS

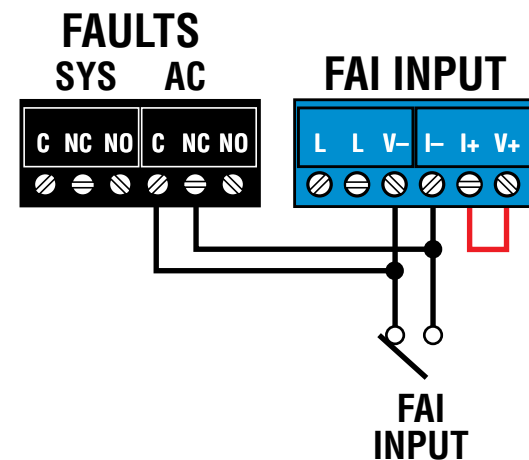

For UL Compliance

Any locking device shall be configured for fail safe operation upon occurrence of an alarm.

As shown in *FAI Activation with a Normally Closed Relay Contact* above

Activation with a Normally Closed Relay Contact

FAI Activates when the NC contact OPENS.

FAI Deactivates when the NC contact CLOSES.

Note: FAI with a NC contact cannot be tested by removing the terminal strip, as this will remove the jumper wires from V+ and V- as well. To test, remove one wire going to the NC Contact.

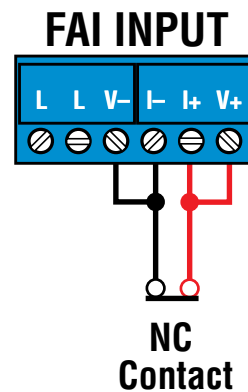

Activation with a Voltage Input

FAI Activates when voltage is APPLIED in the correct polarity. FAI Deactivates when voltage is REMOVED or the polarity of the voltage is REVERSED. Polarity shown in the ACTIVATED state

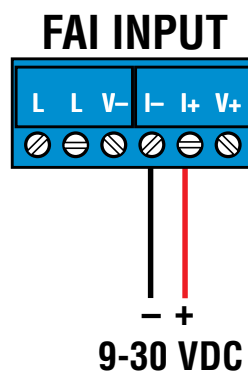

Appendix 2 – Tamper Switch Wiring

All FlexPower DC systems with an enclosure include a normally closed tamper switch for monitoring by the host panel. The tamper switch can either be brought into a dedicated input in the panel (see the panel's instructions), to the Event 1 Input of a NL module, or the tamper switch may be series connected

into the System Fault relay in the FPO supply as shown in the illustration.

Any UL1076 installation must use the tamper switch to indicate the opening or removal of the front door of the enclosure.

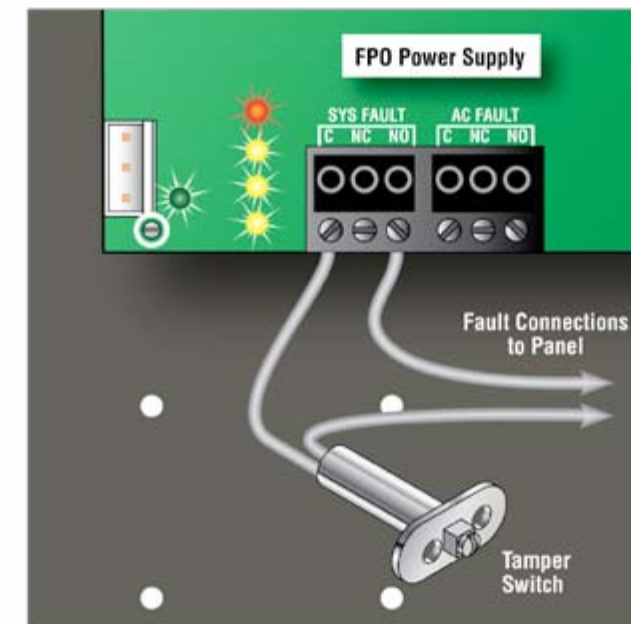

Appendix 4 – User Certificate

Below is a certificate required for UL603 installations, to be cut out, framed and hung adjacent to the FlexPower Power Supply system after installation. It contains the required battery information, as specified in UL603.

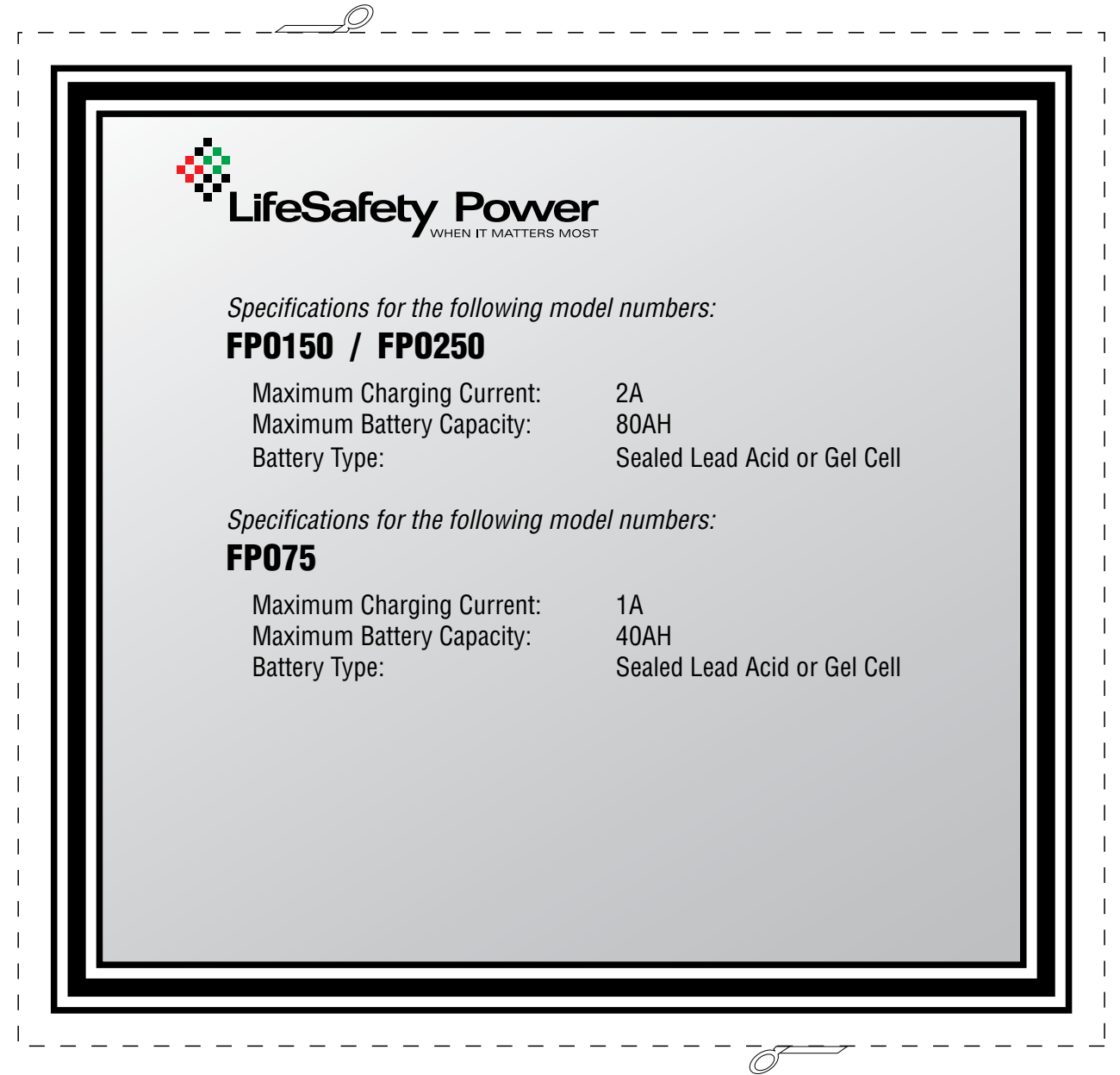

UL Compliance Verification Sheet

General - All Applications:

1. The power supply must be installed within the protected area.
2. The LifeSafety Model EB-80 must be used to house the required battery(ies) when capacities of 40 to 80Ah are required. The EB-80 shall be mounted within 6ft of the power supply and the wiring enclosed in conduit.
3. Connections to the SYS FLT, AC FLT, and FAI inputs shall be completed within the same room, not exceeding a length of 100 ft.
4. Do not connect equipment to an AC power source that is controlled by a switch.
5. The LifeSafety Model BDM Battery Disconnect Module must be used.

The following sections cover specific requirements based on application:

UL1076, Proprietary Burglar Alarm Applications:

1. The LifeSafety Model TS-20 tamper switch must be employed to monitor the power supply and EB-80 enclosures.
2. To achieve 4 hours of standby at full load current, 40Ah min. battery capacity is required for the FPO75.

S319, Access Control Applications:

1. The LifeSafety Model TS-20 tamper switch must be employed to monitor the power supply and EB-80 enclosures.

LifeSafety Power, Inc.
750 Tower Road, Unit B
Mundelein, IL 60060 USA
www.lifesafetypower.com
Tel (888) 577-2898
info@lifesafetypower.com

LifeSafety Power, FlexPower, DataLink, GreenSmart, FlexConnect, PowerCom, Reliability+, SureCharge, TruWatt, and VSelect are trademarks or registered trademarks of LifeSafety Power Inc. or its affiliates.

Important: All information, including illustrations, is believed to be reliable. Users, however, should independently evaluate the suitability of each product for their particular application. LifeSafety Power makes no warranties as to the accuracy or completeness of the information, and disclaims any liability regarding its use. LifeSafety Power's only obligations are those in the LifeSafety Power Standard Terms and Conditions of Sale for this product, and in no case will LifeSafety Power or its distributors be liable for any incidental, indirect, or consequential damages arising from the sale, resale, use, or misuse of the product. Specifications are subject to change without notice. In addition, LifeSafety Power reserves the right to make changes—without notification to Buyer—to processing or materials that do not affect compliance with any applicable specification.