

DETAILS

Product Number	C13234_SATU-S
Family	Satu
Type	Lens array
Color	clear
Diameter	21,8 mm
Height	8,9 mm
Style	round
Optic Material	PMMA
Holder Material	
Fastening	glue, pin
Status	production ready
ROHS Compliant	Yes
Date Updated	6/05/2014



OPTICAL PROPERTIES

LED	Viewing	Light	Effi-		Connector
	Angle	Beam	ciency	cd/lm	
XT-E	24 deg	Spot	89 %	3.400	-
XP-G2	26 deg	Spot	85 %	3.300	-
XP-E2	20 deg	Spot	86 %	5.500	-
XB-D	21 deg	Spot	80 %	3.500	-
XP-E	20 deg	Spot	85 %	4.600	-
XP-G	25 deg	Spot	83 %	2.900	-
H35C0 (LEMWA33)	27 deg	Spot	86 %	2.800	-
H35B0 (LEMWA32)	24 deg	Spot	82 %	3.200	-
LUXEON T	27 deg	Spot	88 %	2.700	-
LUXEON H50-2	sim: 24	Spot	sim: 90 %	sim: 4.000	-
LUXEON TX	26 deg	Spot	86 %	2.800	-
NF2x757A	23 deg	Spot	85 %	2.800	-
NVSxx19B/NVSxx19C	sim: 26	Spot	sim: 87 %	sim: 3.130	-
Oslon Square EC	24 deg	Spot	85 %	3.200	-
Oslon SSL 80	18 deg	Spot	81 %	4.400	-
Synios P2720 1/2 mm	sim: 16	Spot	sim: 94 %	sim: 7.890	-
LH351Z	24 deg	Spot	87 %	3.400	-
Z8Y22P	sim: 27	Spot	sim: 87 %	sim: 2.690	-

Relative intensity of C13234_SATU-S_(XB-D)

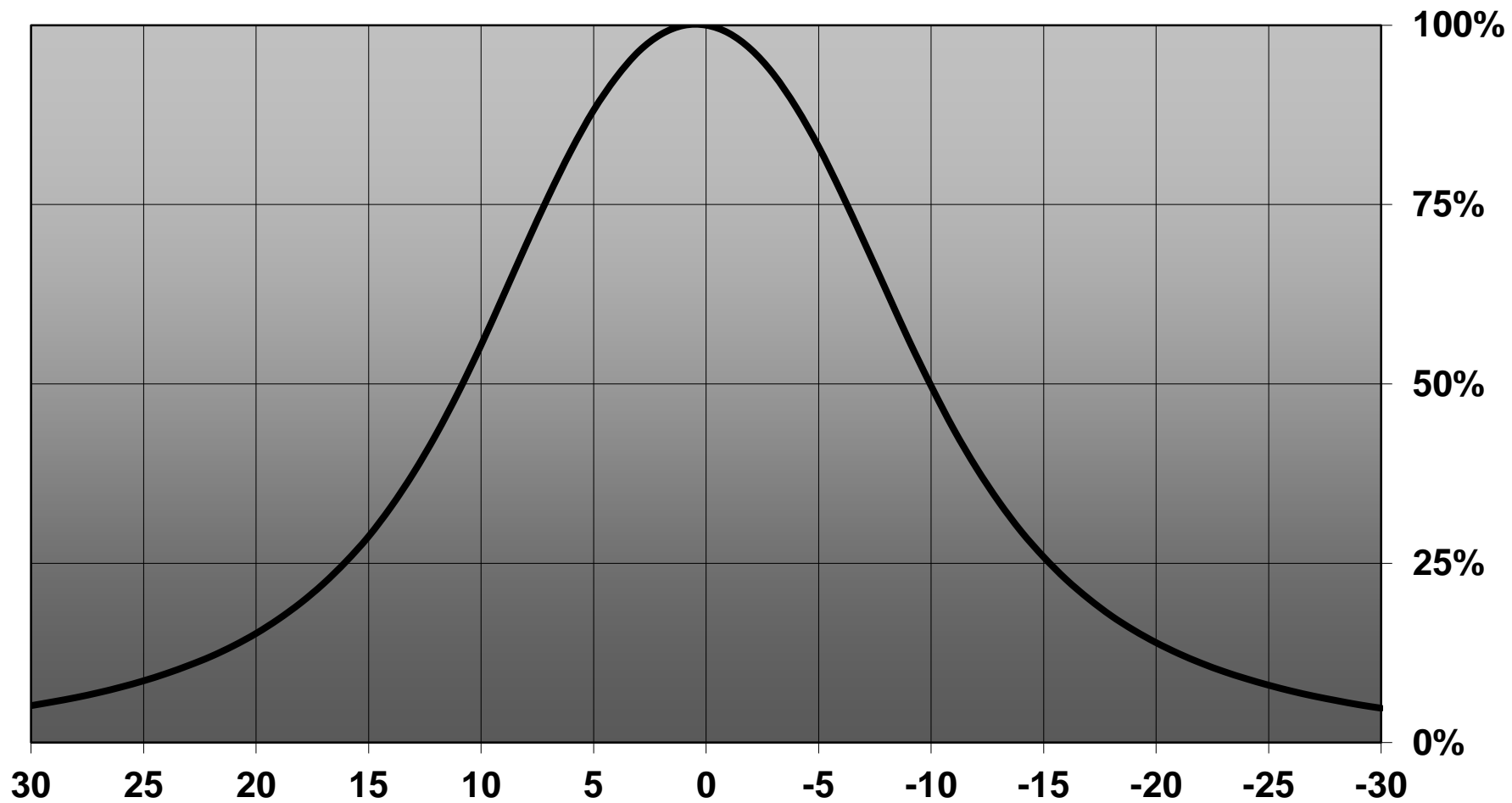

Relative intensity of C13234_SATU-S_(XP-E)

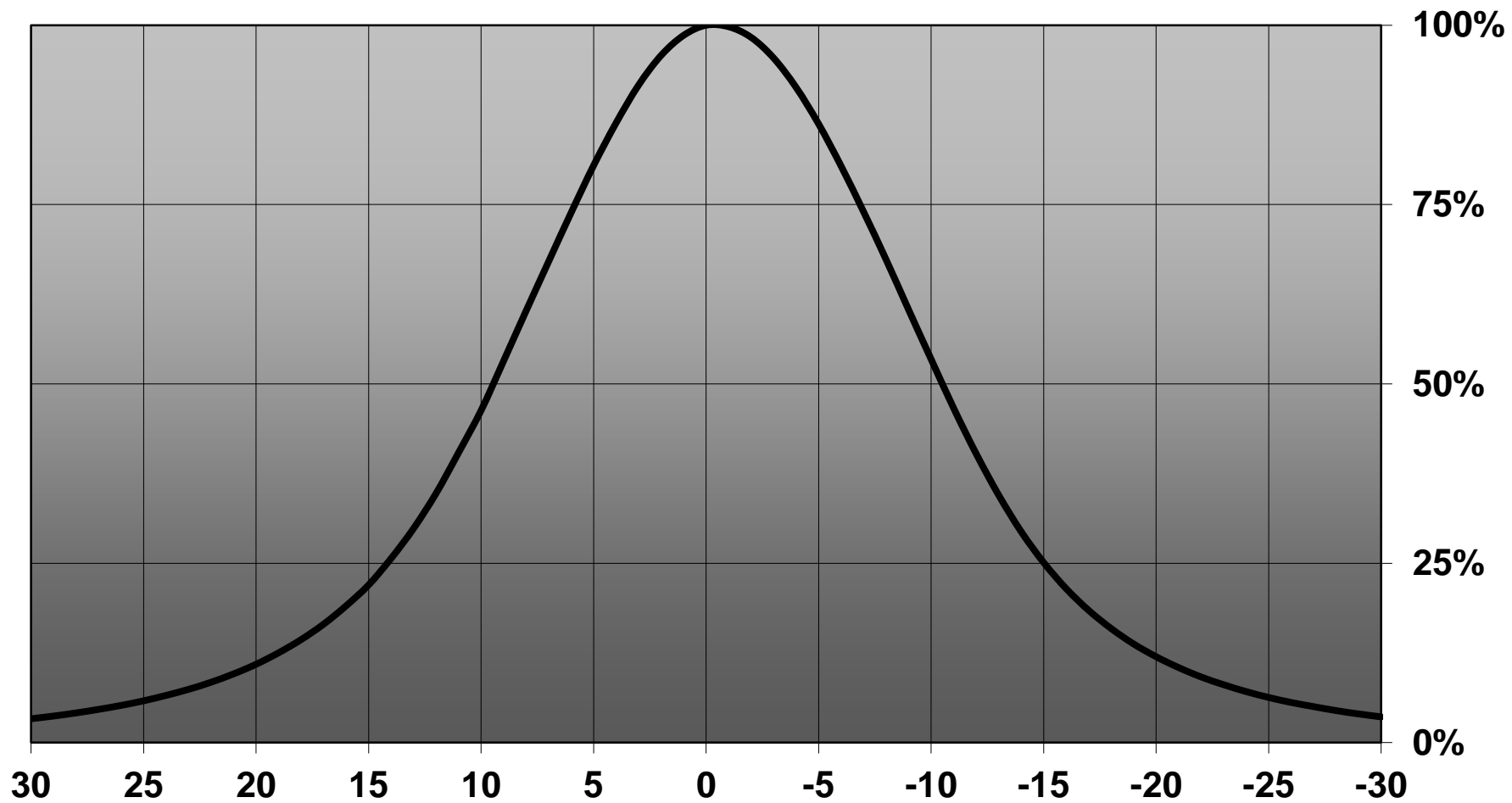

Relative intensity of C13234_SATU-S_(XP-G)

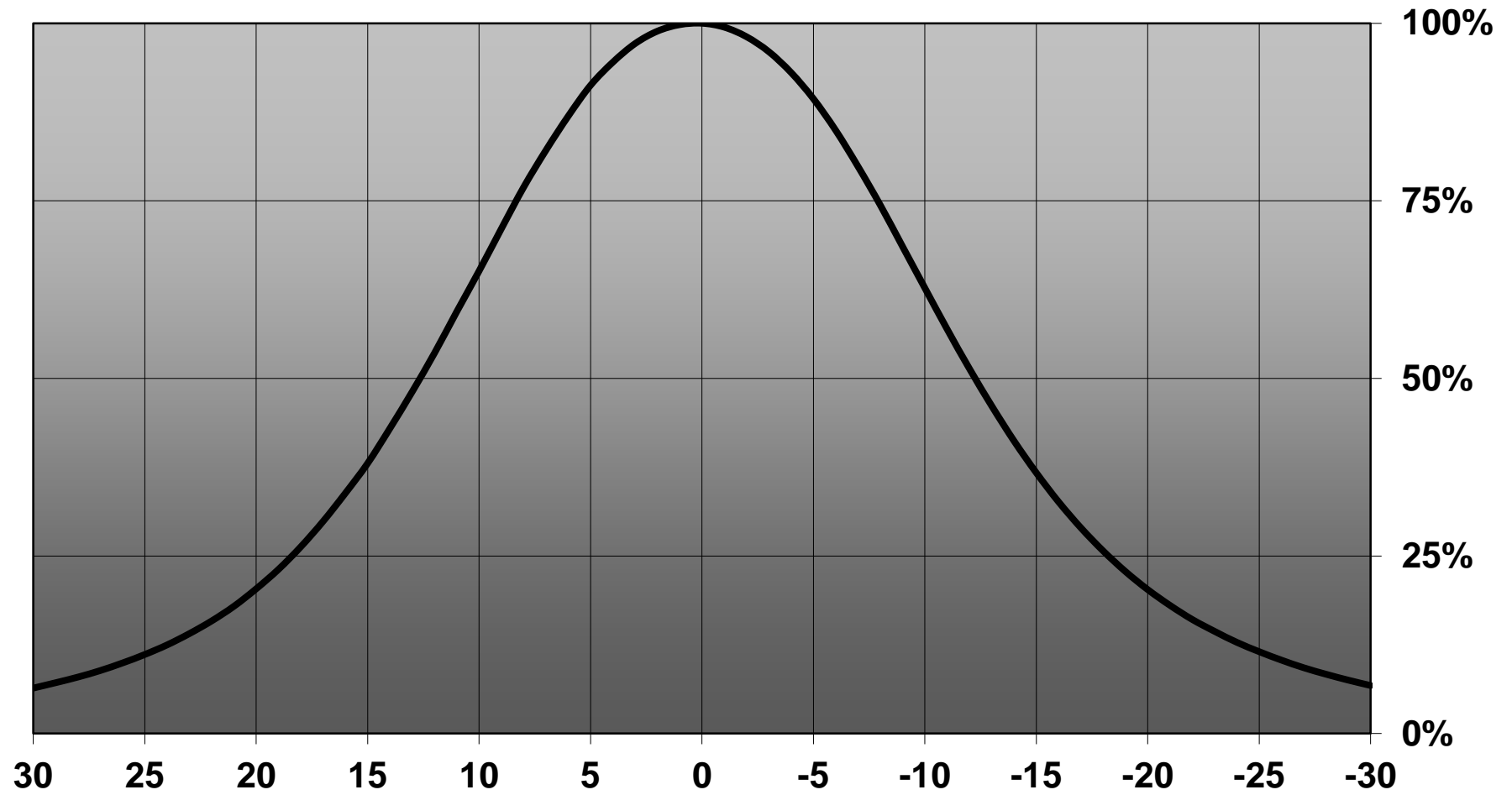

Relative intensity of C13234_SATU-S_(SSL80)

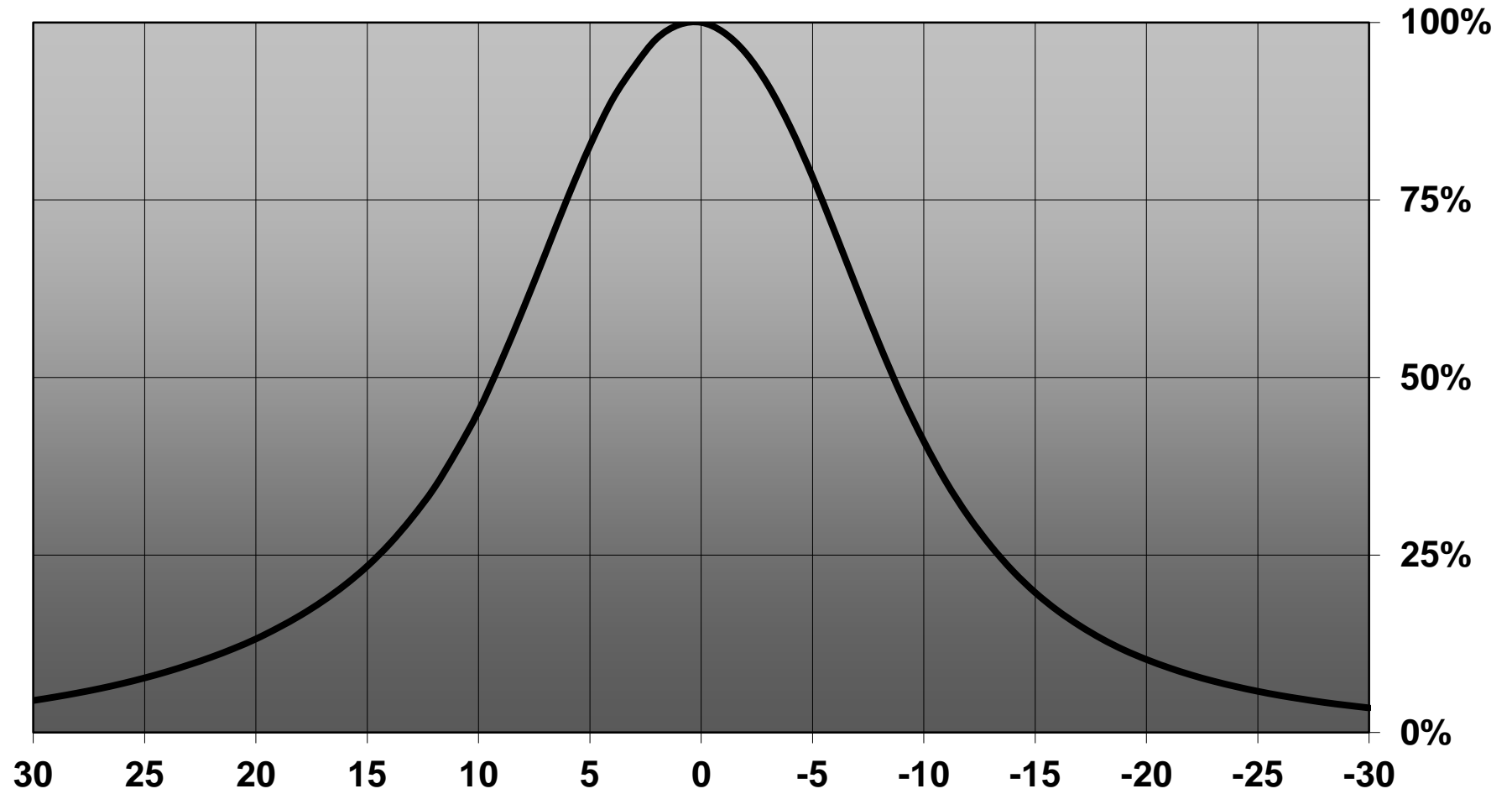

D

C

B

A

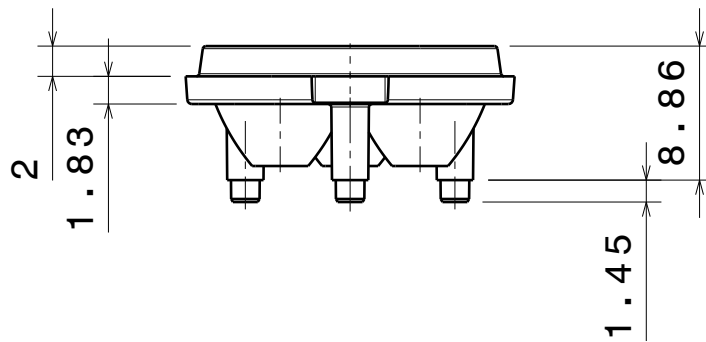
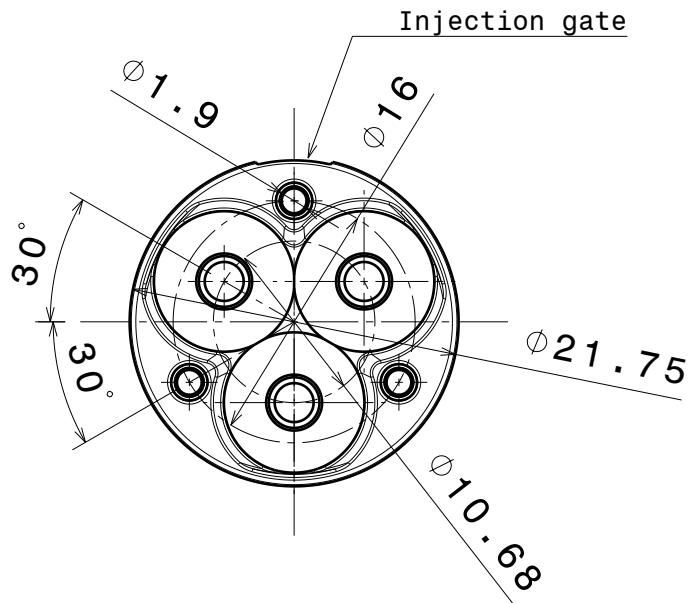
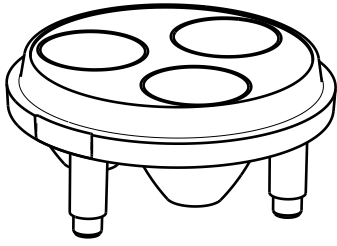

INDEX	PART NO	DESCRIPTION	MATERIAL	COLOUR
1	C13234	SATU-S	PMMA	

Tolerances if not otherwise shown
According to DIN ISO 2768-1
Linear measures:
Up to 30mm class M, otherwise class C.
According to DIN ISO 2768-2
Form and position: class L

LEDiL

Ledil Oy
Salorankatu 10
FIN 24240 SALO
Finland

THIRD ANGLE PROJECTION:

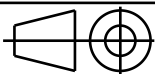

DRAWING TITLE

C13234_SATU-S

This drawing is the property
of LEDiL Oy. It may not be
reproduced, copied or
communicated without a written
agreement with LEDiL Oy."

SIZE PART NUMBER

A4

C13234

SCALE	2:1	WEIGHT	2 g	SHEET	1/1
-------	-----	--------	-----	-------	-----

D

A

Luminaire: Ledil Oy C13234_SATU-S_(XP-G2) Efficiency=85%
Lamps: 1 x CREE XP-G2 (XPGBWT-L1-0000-00G51) 303lm@250mA CCT=7027K P=2.2W I=250mA

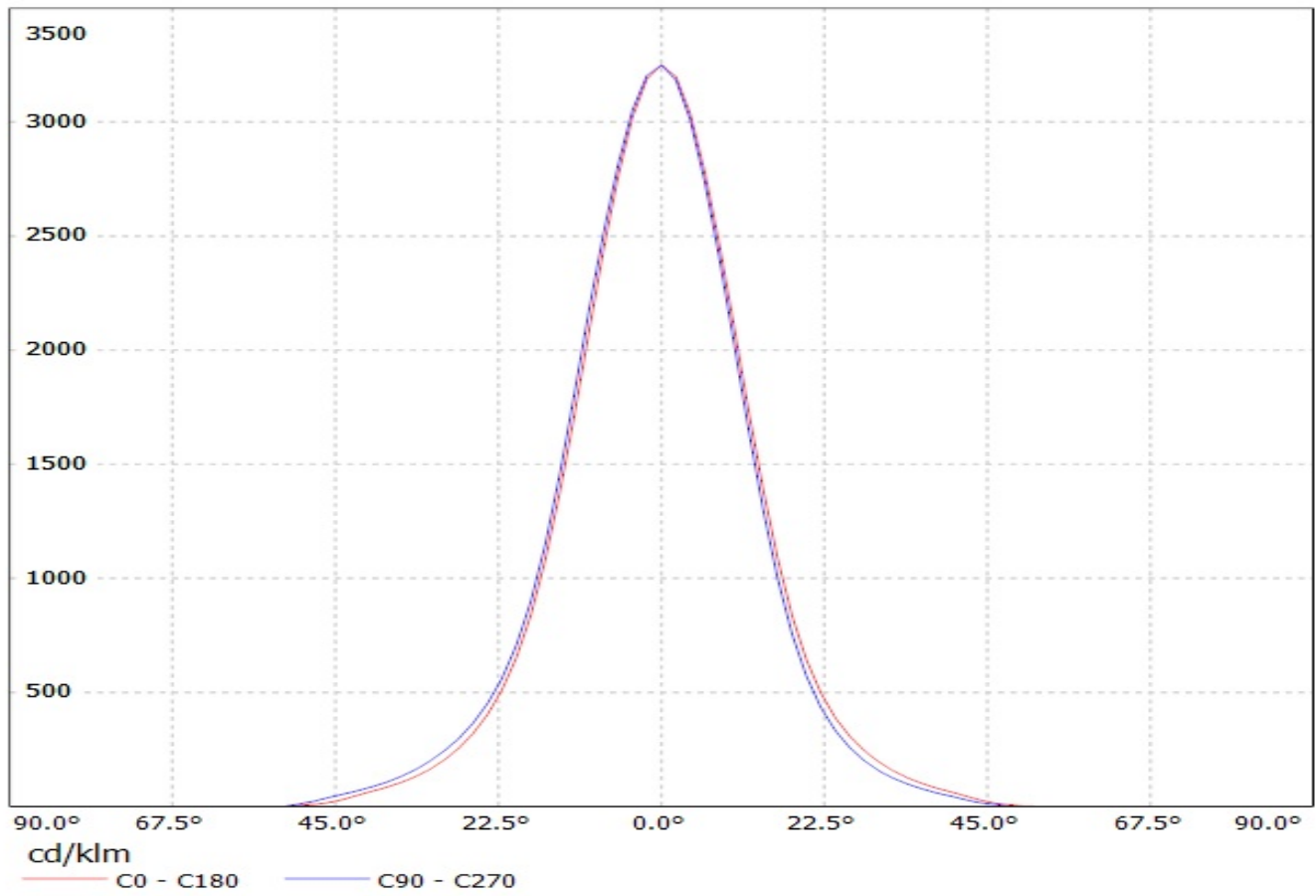

Luminaire: Ledil Oy C13234_SATU-S_(XP-E2) Efficiency=86%
Lamps: 1 x CREE XP-E2 (XPEBWT-L1-0000-00CE7) 243lm@250mA CCT= 3174K P=2.2W I=250mA

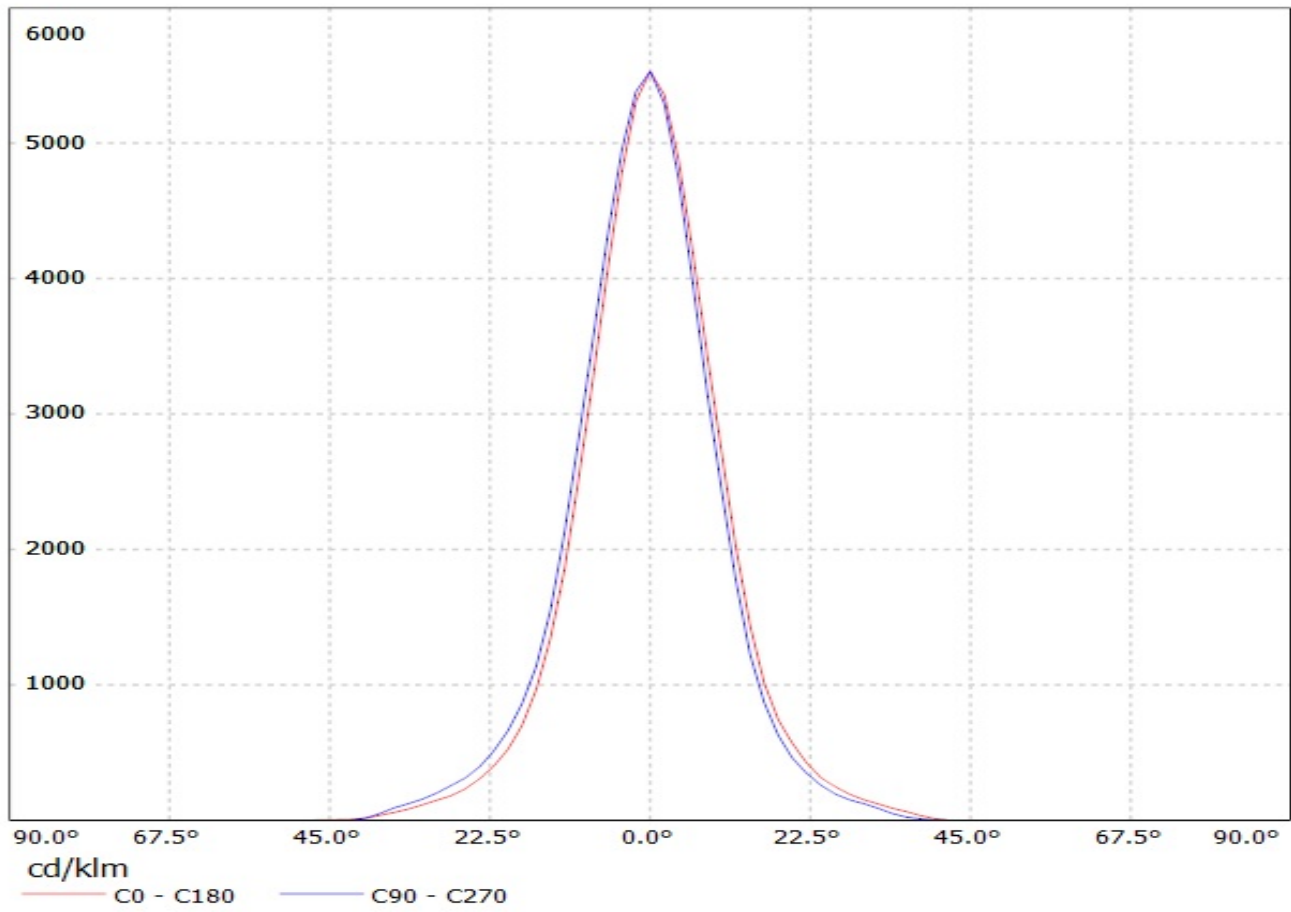

Luminaire: Ledil Oy C13234_SATU-S_(3535_3W) Efficiency=86%
Lamps: 1 x LG 3535 Ceramic 3W (LEMWA33) 278lm@250mA CCT=6284K P=2.2W I=250mA

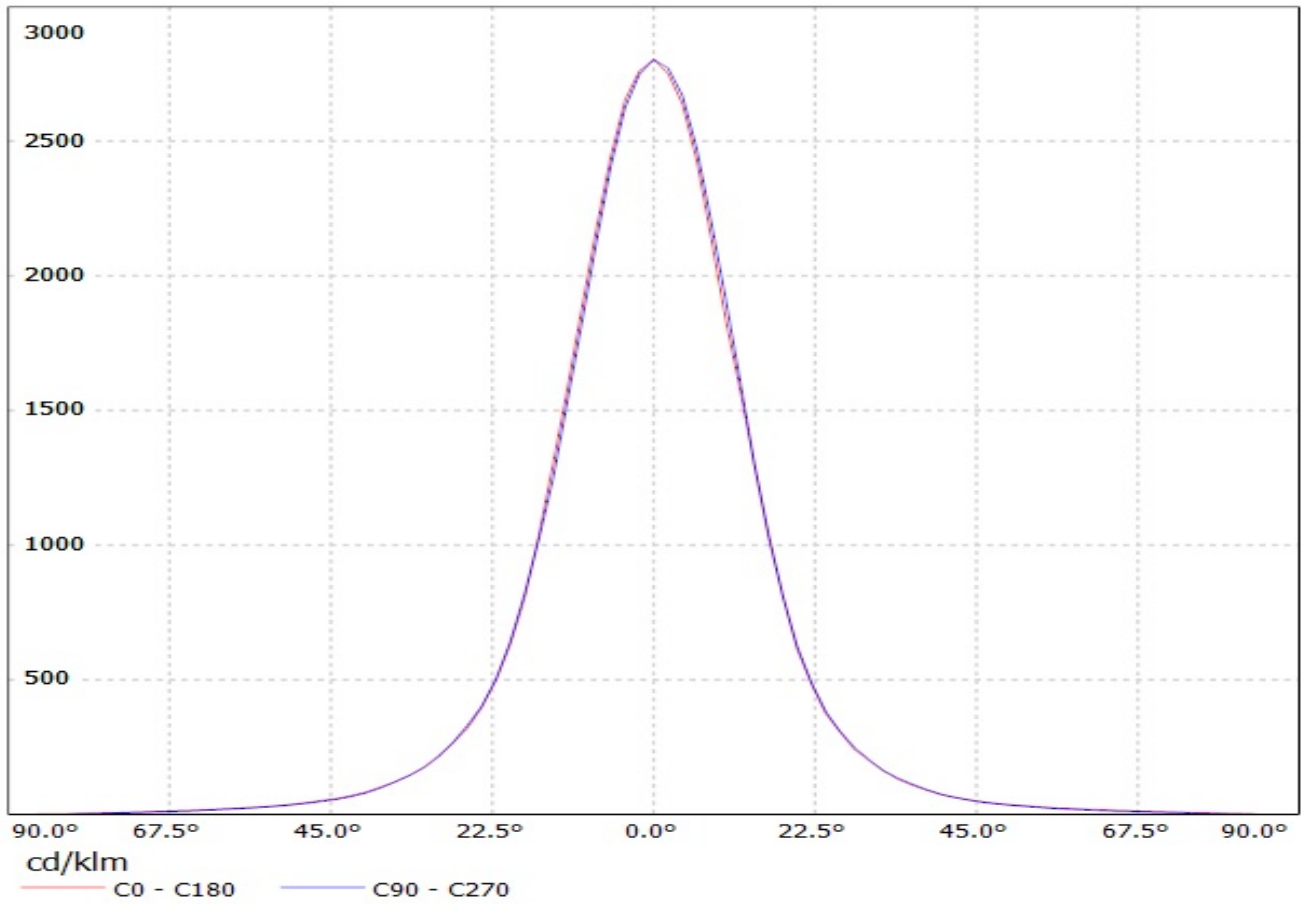

Luminaire: Ledil Oy C13234_SATU-S_(LG-3535-2W) Efficiency=82%
Lamps: 1 x LG 3535 Ceramic 2W (LEMWA32) 192lm@250mA CCT=7784K P=2.2W I=250mA

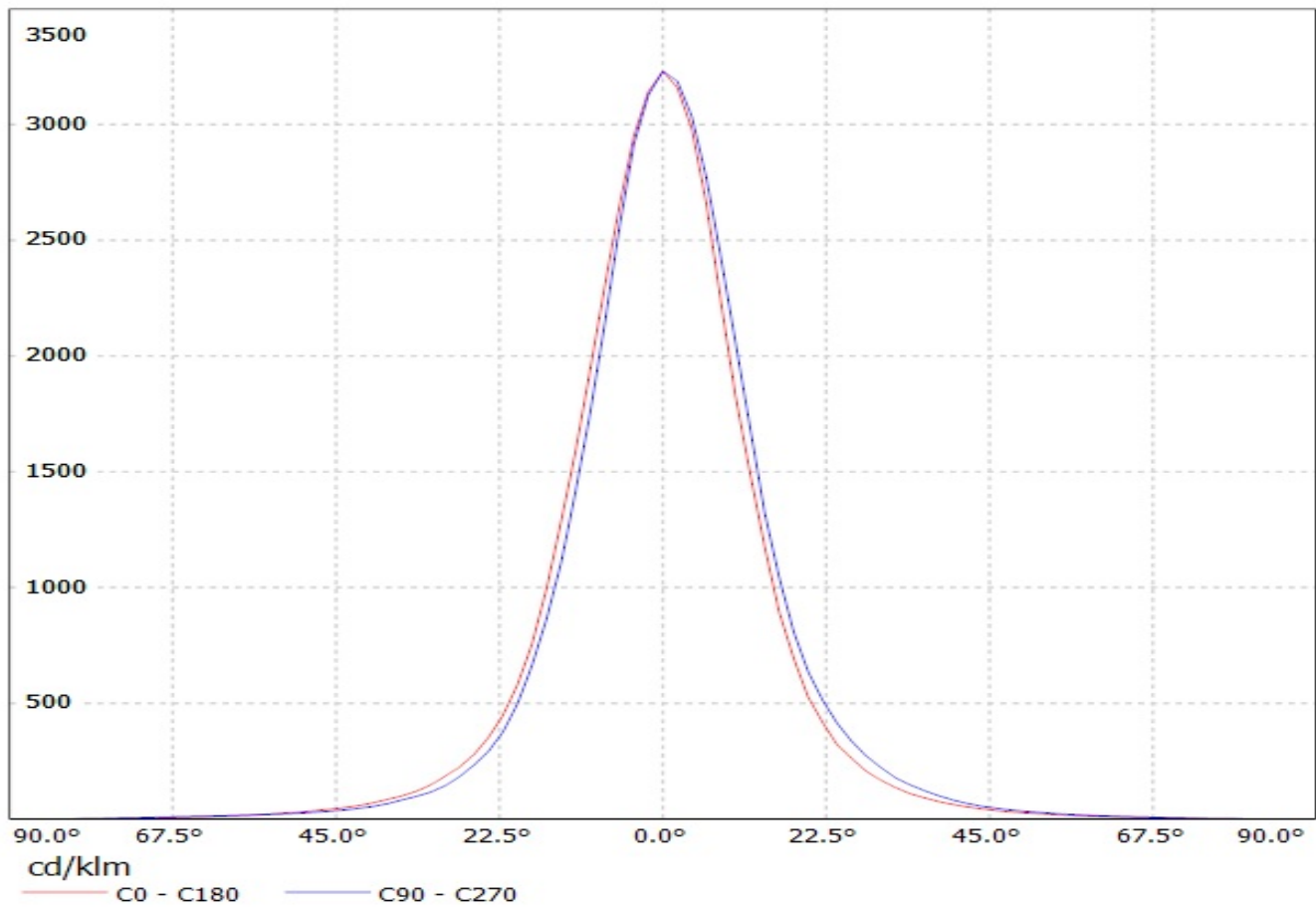

Luminaire: LEDiL Oy C13234_SATU-S_(LUXEON_T) Eff.88%
Lamps: 1 x LUXEON_T (214lm@250mA)

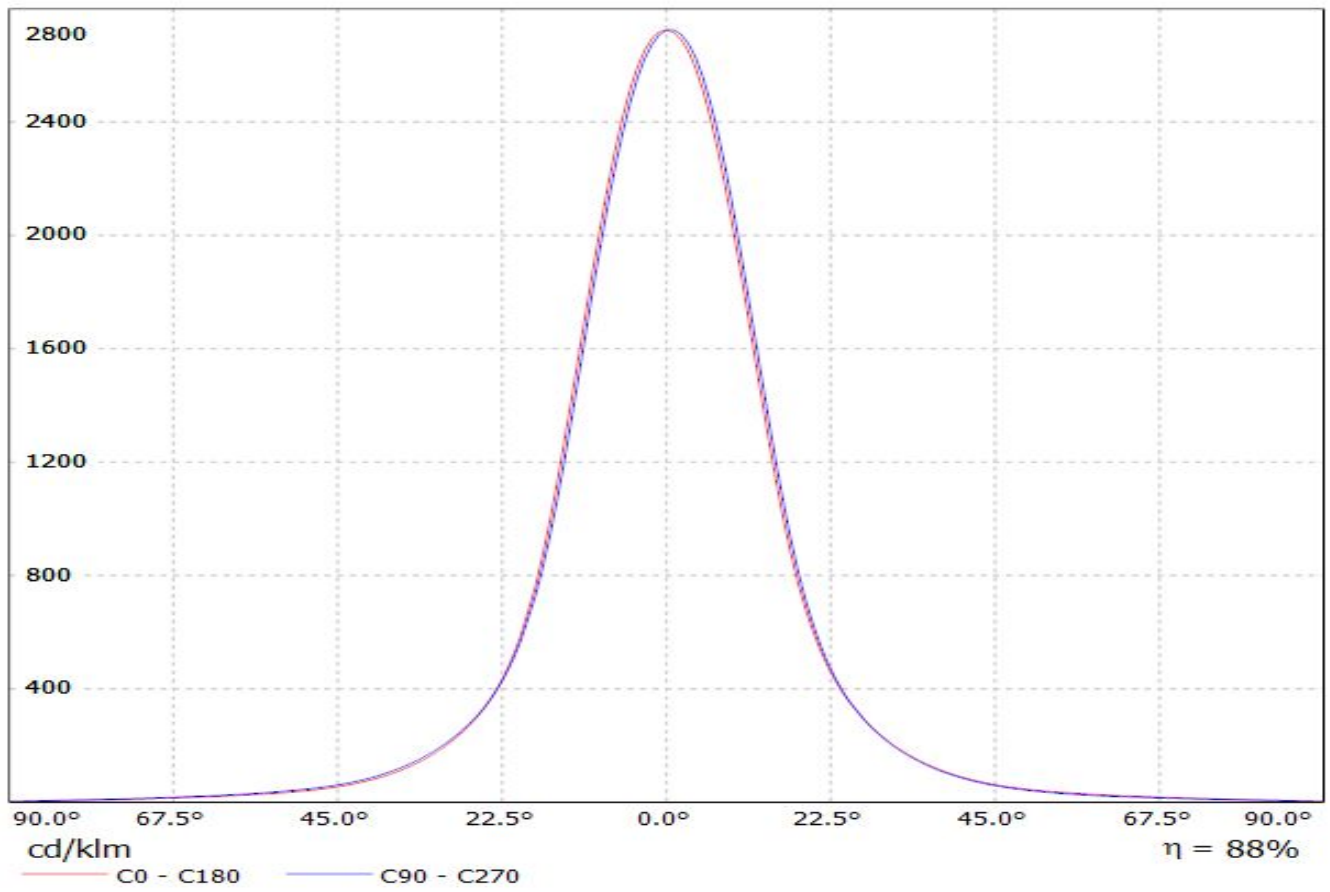

Luminaire: Ledil Oy C13234_SATU-S_(Luxeon_TX) Efficiency=86%
Lamps: 1 x Luxeon TX 250lm @ 250mA CCT= P=2.13W I=250mA

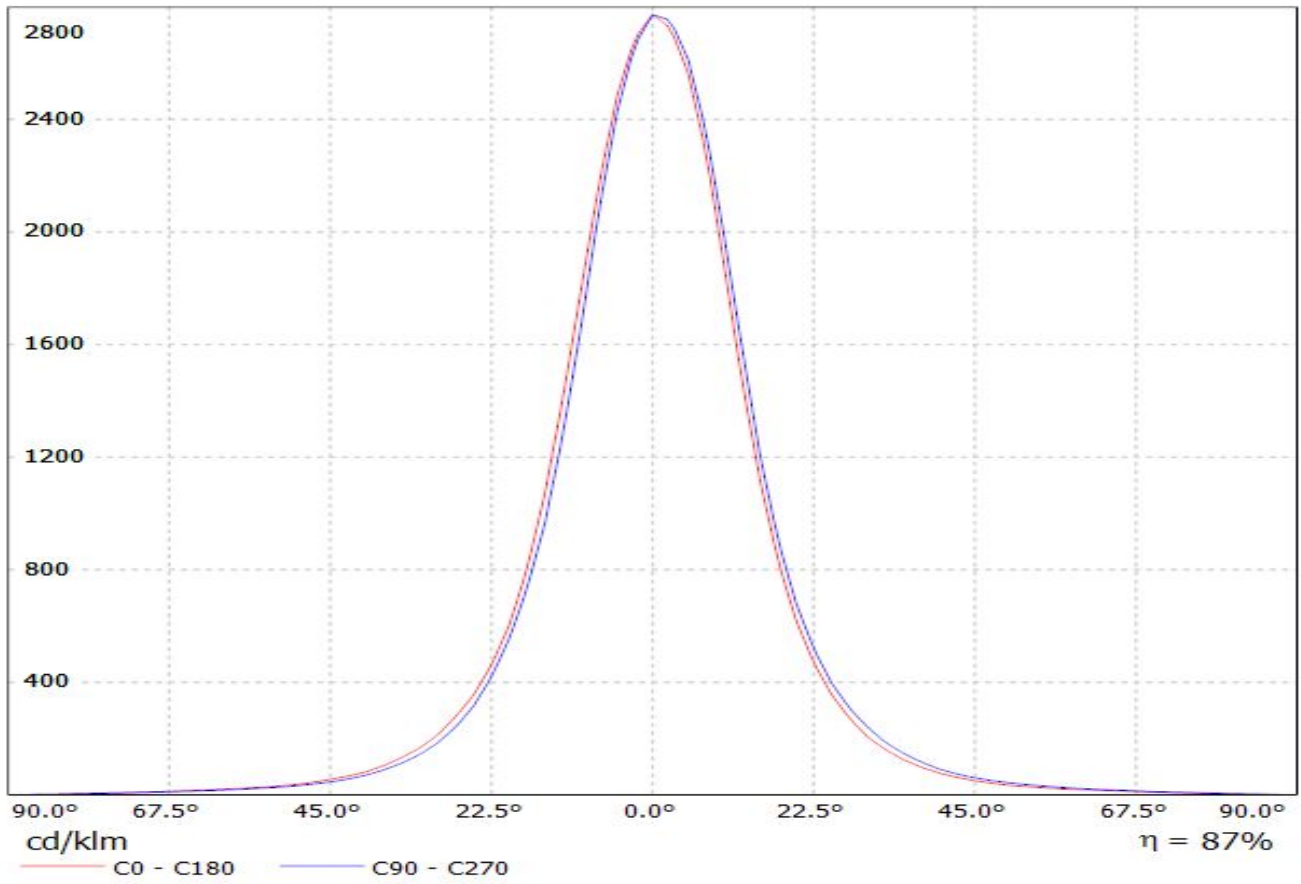

Luminaire: LEDil Oy Luminaire Catalog Number C13234_SATU-S_(NF2x757A) Efficiency=85%
Lamps: 1 x Nichia NF2x757A (NF2W757ART) 197lm @ 100mA CCT=4700K P=1.9W I=100mA

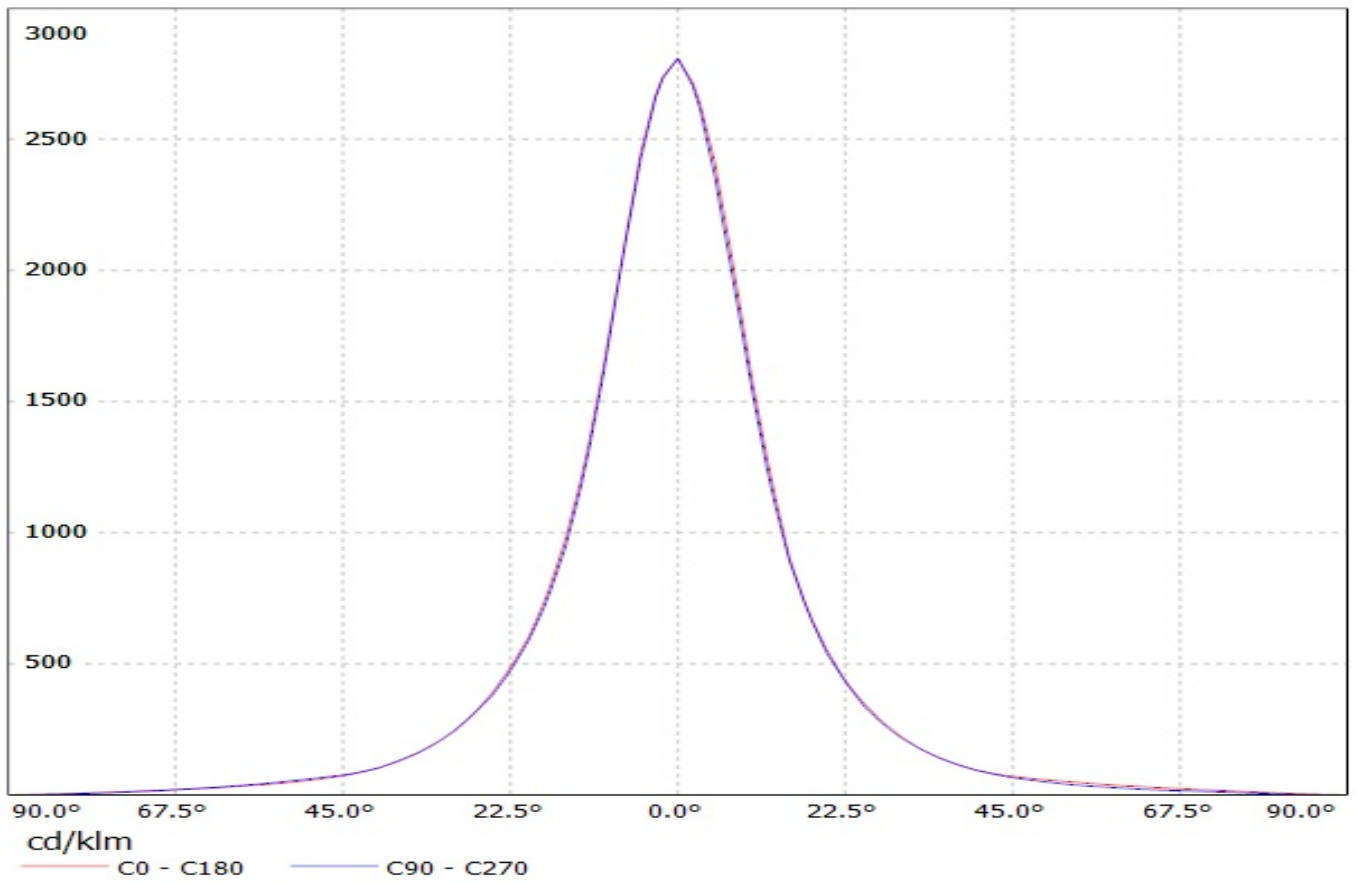

Luminaire: Ledil Oy C13234_SATU-S (Osram Square EC 273lm @ 250mA) Efficiency=85%
Lamps: 1 x Osram Square EC (LCW CQAR.EC-MQMS-SL7N-35) 273lm @ 250mA CCT=3955K P=2,25W I=250mA

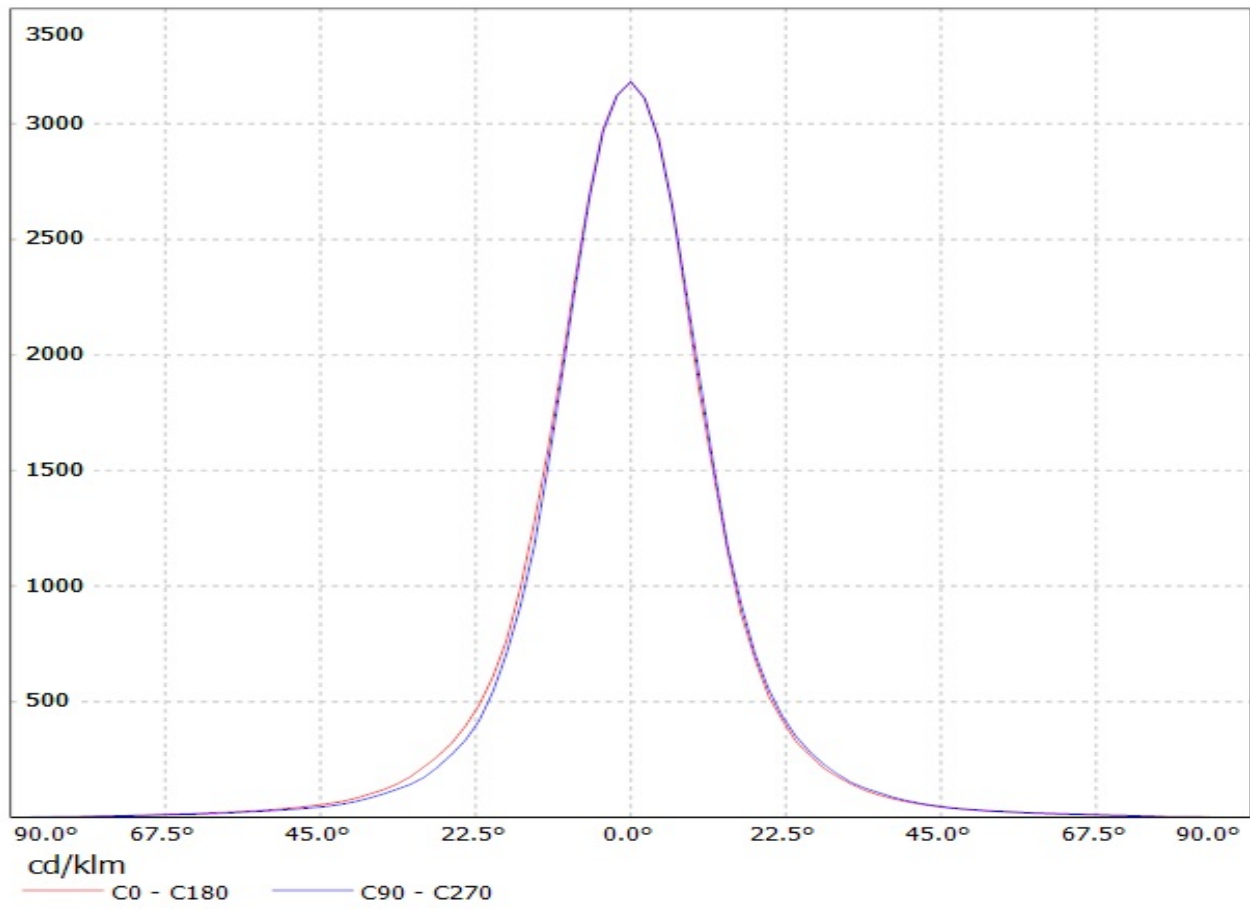

Luminaire: LEDil Oy C13234_SATU-S_(LH351Z)

Lamps: 1 x Samsung LH351Z (234.33lm @ 250mA) CCT=6500K P=2.2W I=250mA

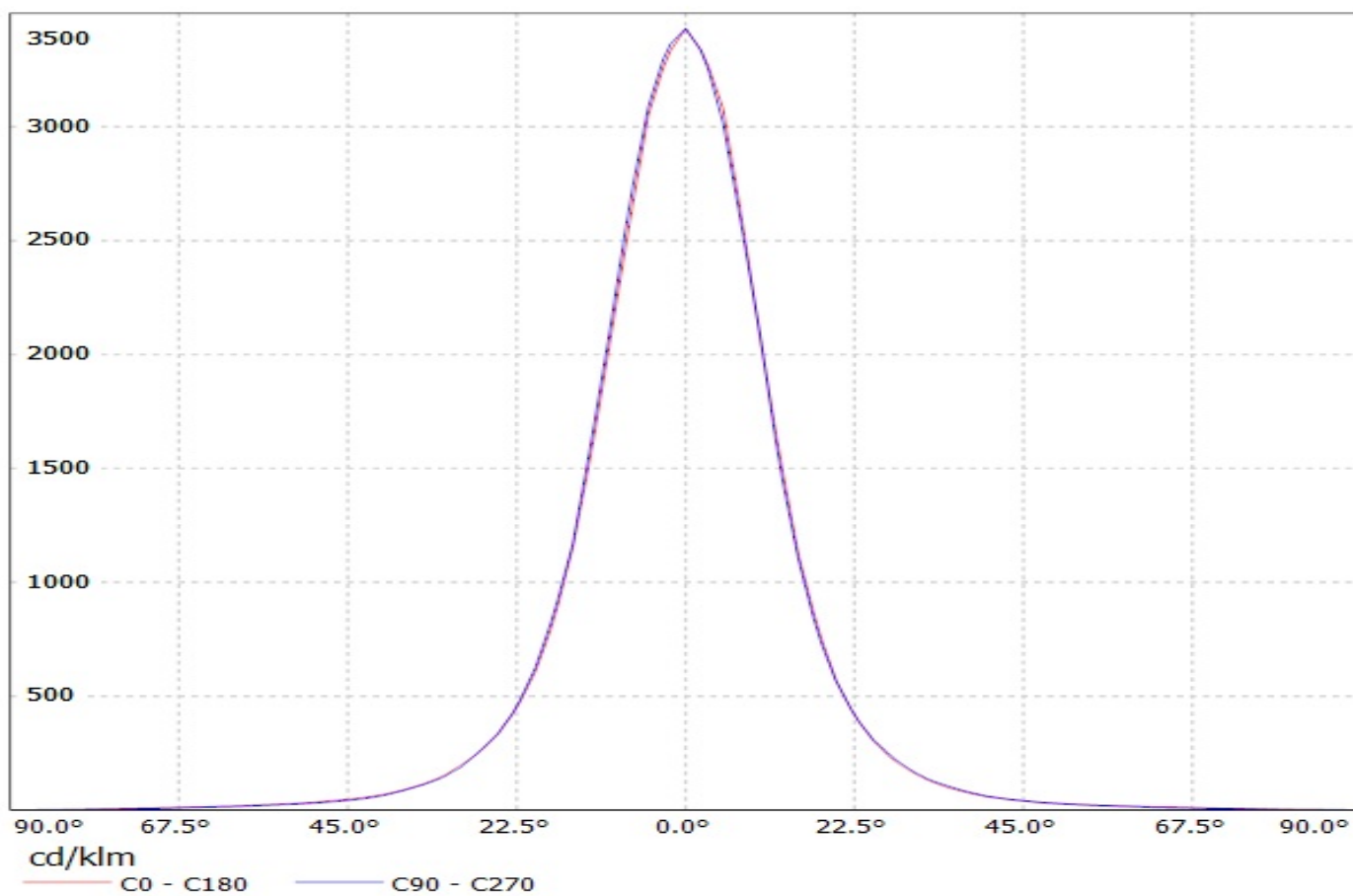

Luminaire: Ledil Oy C13234_SATU-S_SEOUL_Z8Y22+_SIMULATED
Lamps: 1 x SEOUL Z8Y22 Plus

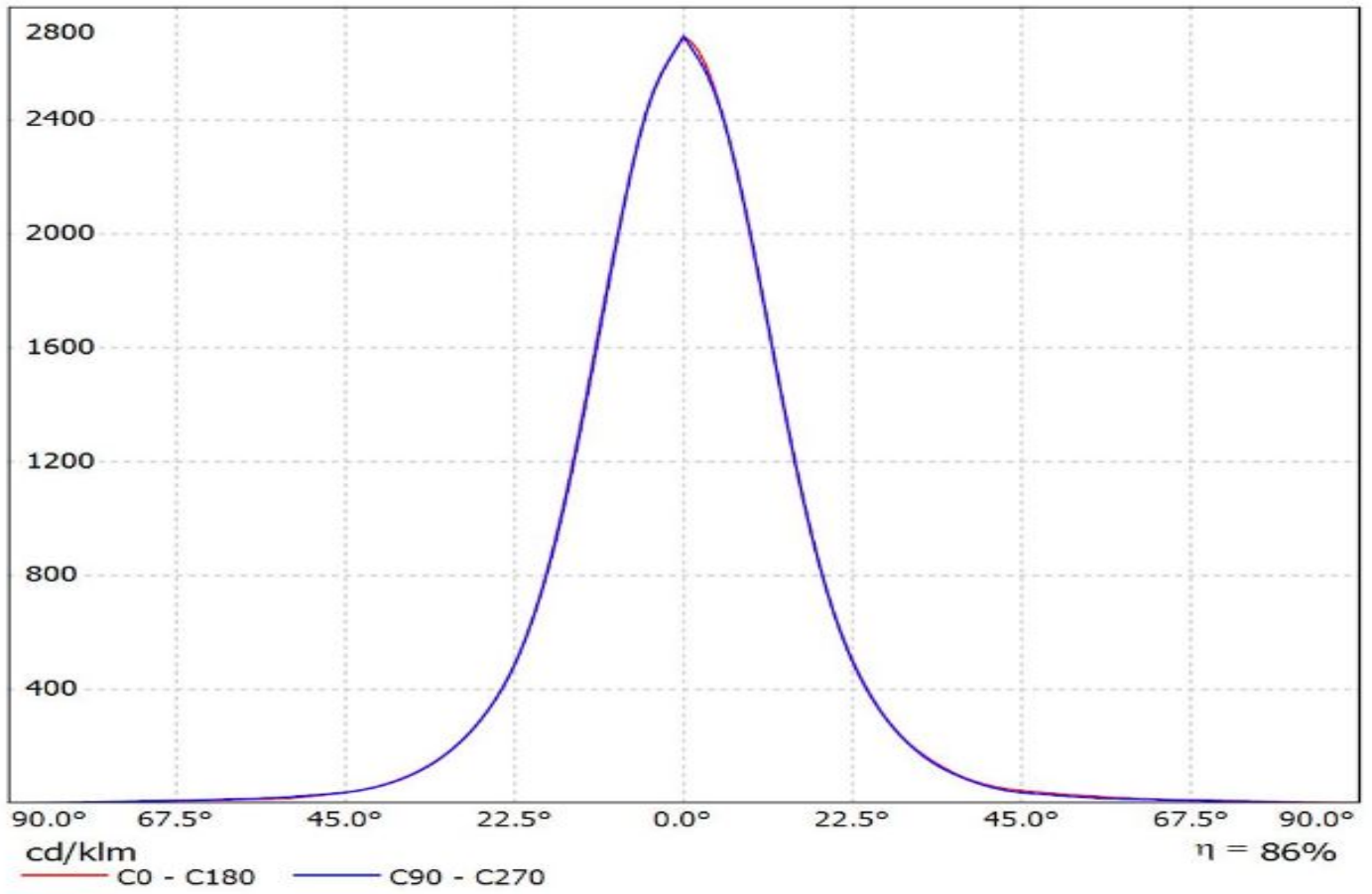

Luminaire: Ledil Oy C13234_SATU-S_(XP-G2) Efficiency=85%

Lamps: 1 x CREE XP-G2 (XPGBWT-L1-0000-00G51) 303lm@250mA CCT=7027K P=2.2W I=250mA

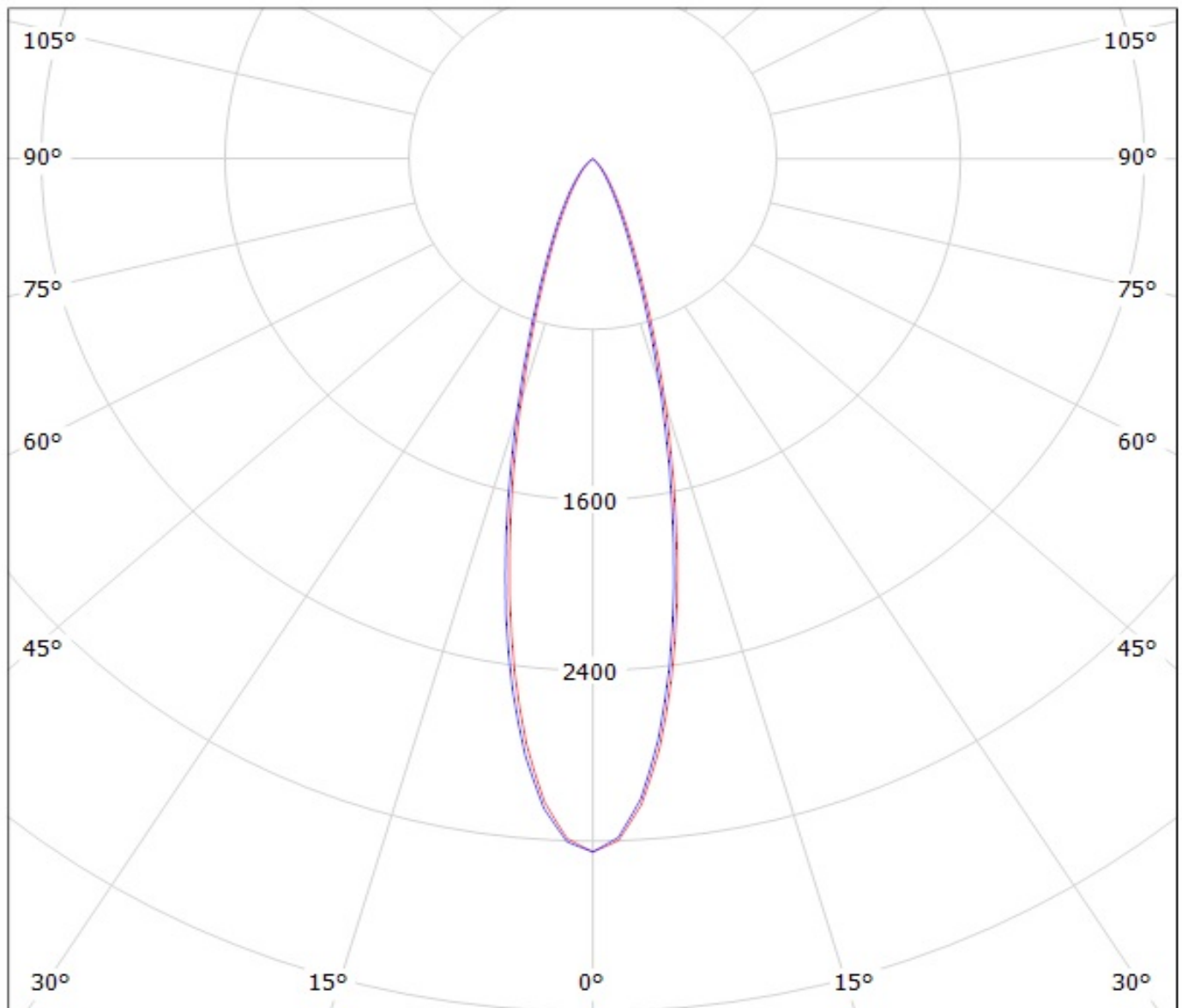

cd/klm

— C0 - C180

— C90 - C270

Luminaire: Ledil Oy C13234_SATU-S_(XP-E2) Efficiency=86%

Lamps: 1 x CREE XP-E2 (XPEBWT-L1-0000-00CE7) 243lm@250mA CCT= 3174K P=2.2W I=250mA

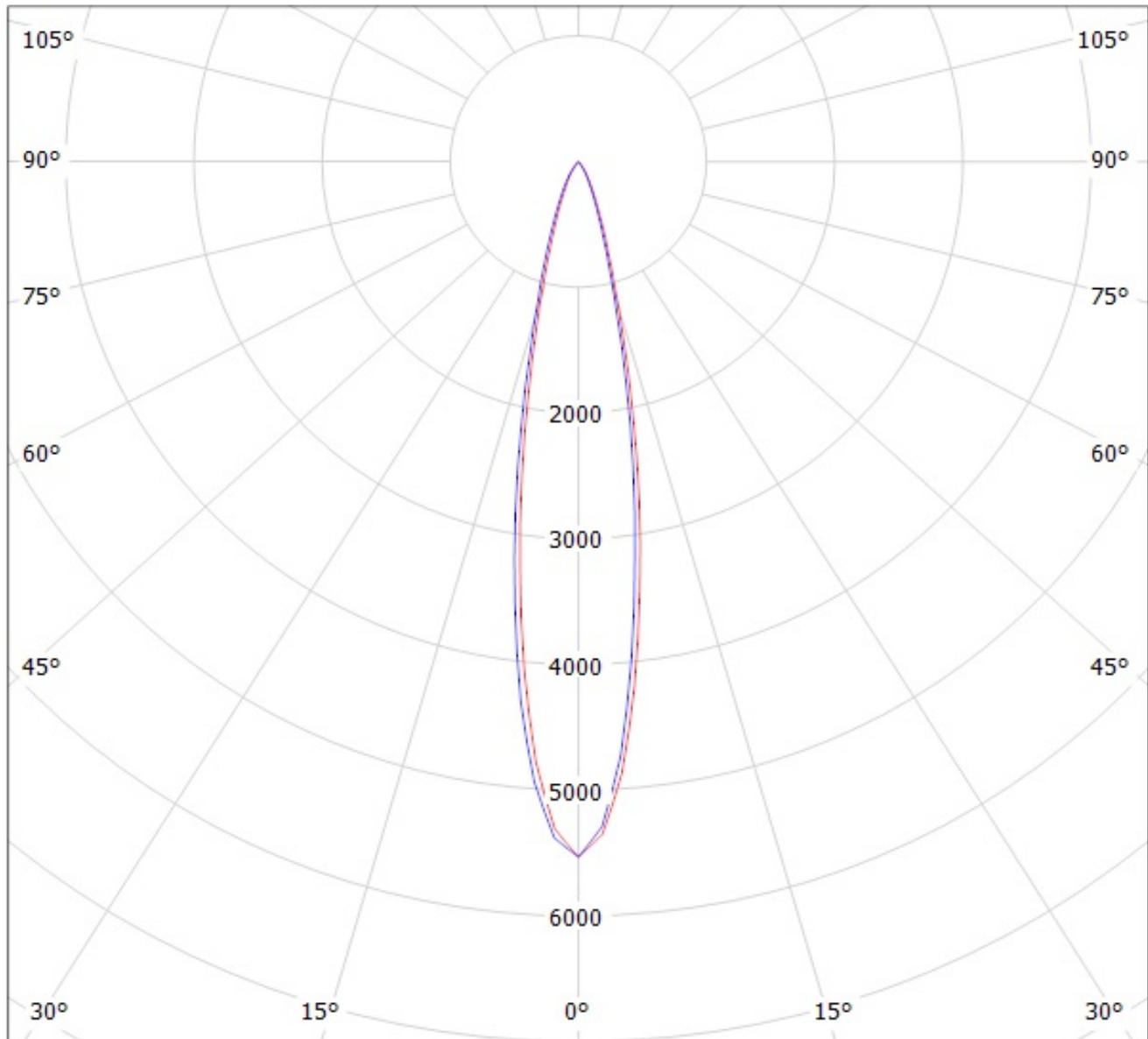

cd/klm

— C0 - C180

— C90 - C270

Luminaire: Ledil Oy C13234_SATU-S_(3535_3W) Efficiency=86%

Lamps: 1 x LG 3535 Ceramic 3W (LEMWA33) 278lm@250mA CCT=6284K P=2.2W I=250mA

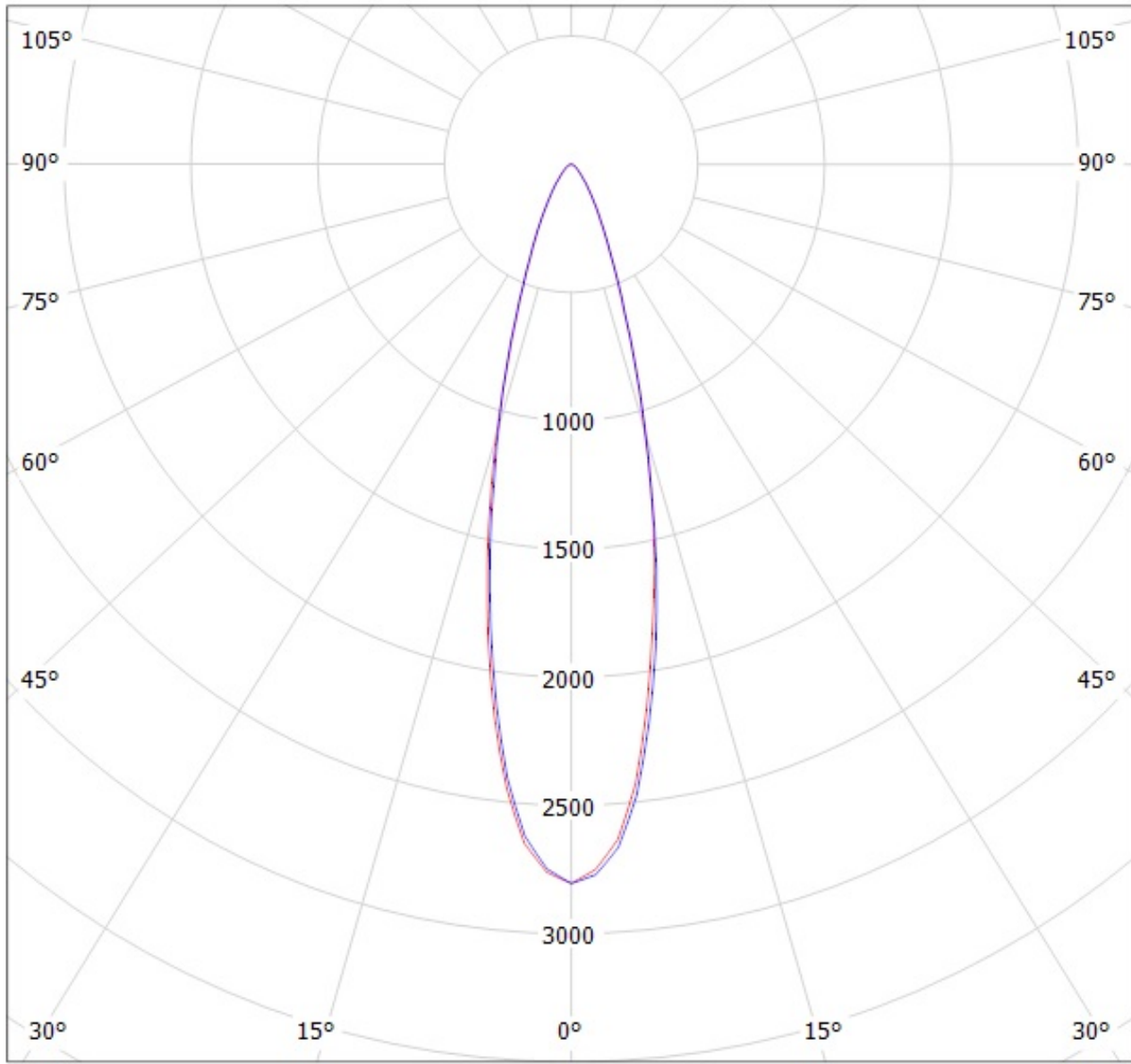

cd/klm

— C0 - C180

— C90 - C270

Luminaire: Ledil Oy C13234_SATU-S_(LG-3535-2W) Efficiency=82%
Lamps: 1 x LG 3535 Ceramic 2W (LEMWA32) 192lm@250mA CCT=7784K P=2.2W I=250mA

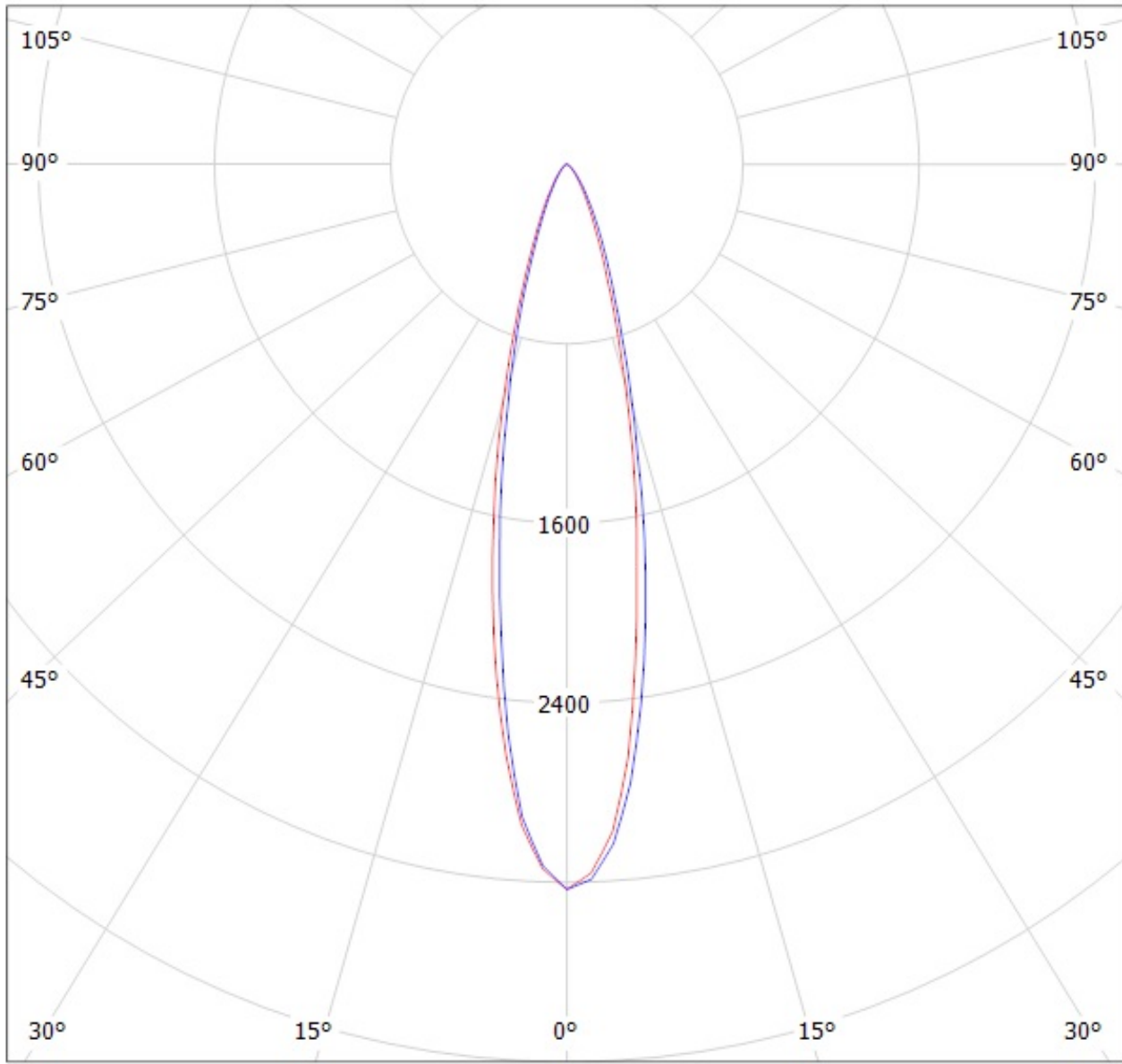

cd/klm

— C0 - C180 — C90 - C270

Luminaire: LEDiL Oy C13234_SATU-S_(LUXEON_T) Eff.88%
Lamps: 1 x LUXEON_T (214lm@250mA)

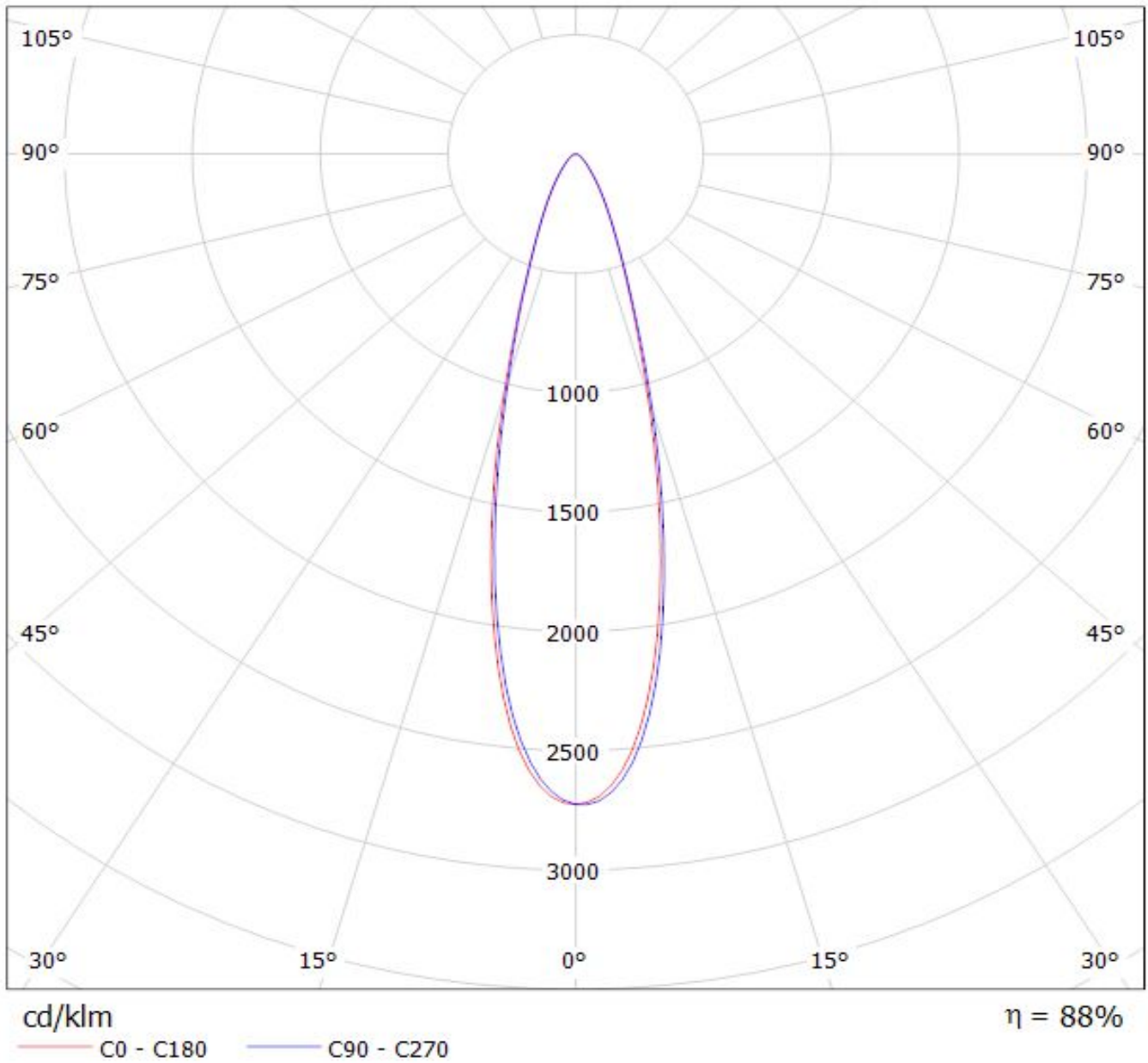

Luminaire: Ledil Oy C13234_SATU-S_(Luxeon_TX) Efficiency=86%
Lamps: 1 x Luxeon TX 250lm @ 250mA CCT= P=2.13W I=250mA

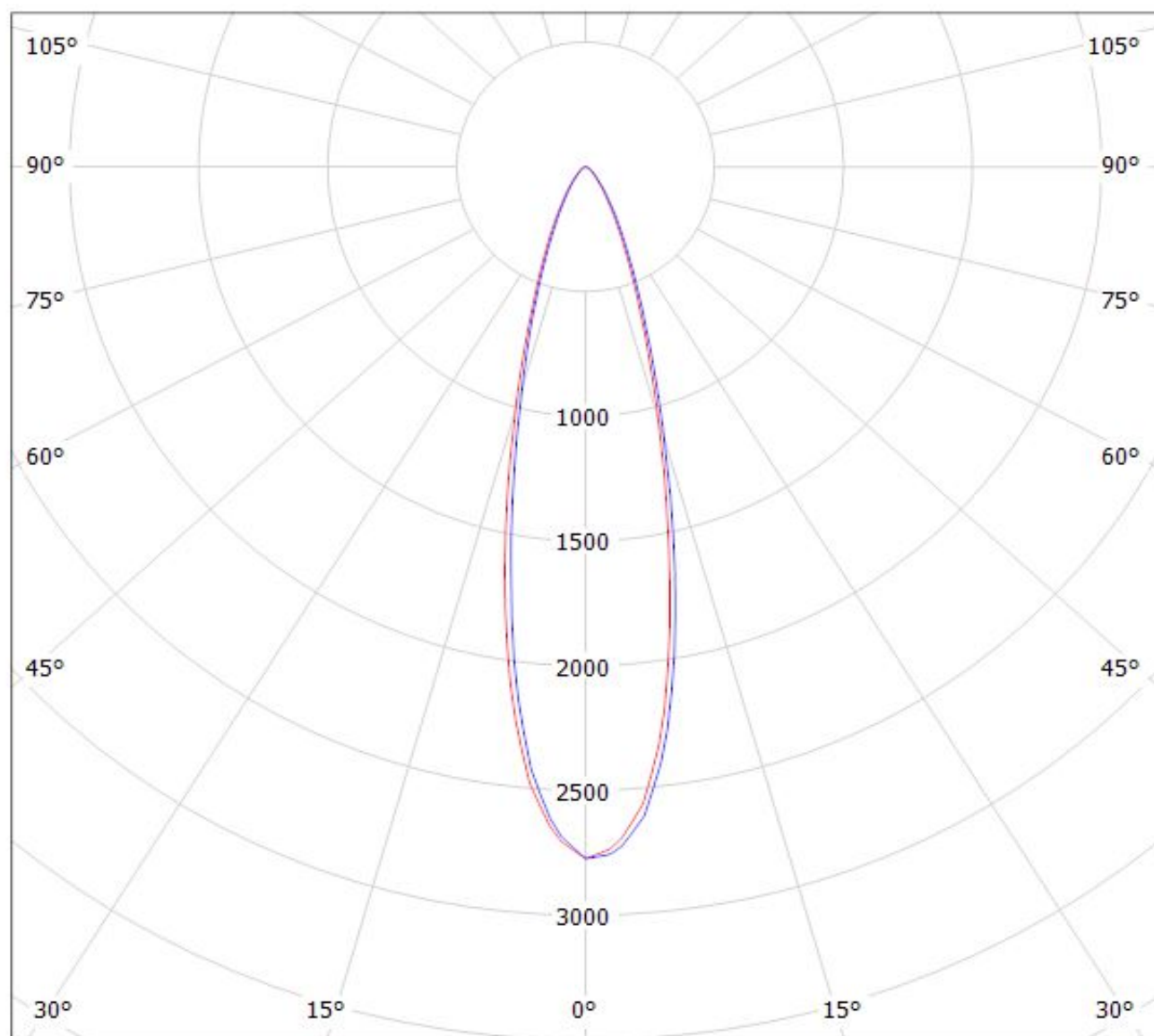

cd/klm

— C0 - C180

— C90 - C270

$\eta = 87\%$

Luminaire: LEDil Oy Luminaire Catalog Number C13234_SATU-S_(NF2x757A) Efficiency=85%
Lamps: 1 x Nichia NF2x757A (NF2W757ART) 197lm @ 100mA CCT=4700K P=1.9W I=100mA

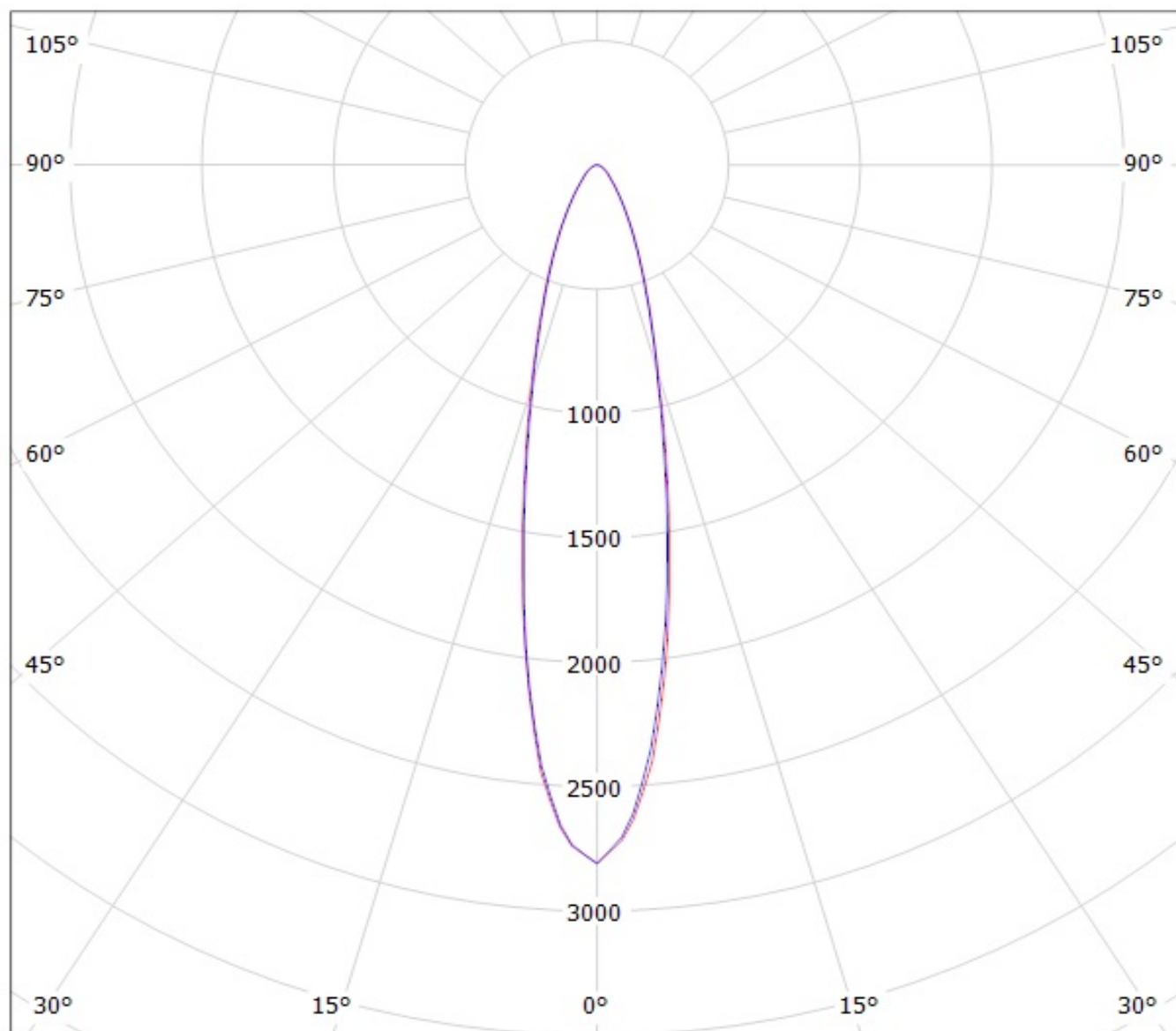

cd/klm

— C0 - C180

— C90 - C270

Luminaire: Ledil Oy C13234_SATU-S (Osram Square EC 273lm @ 250mA) Efficiency=85%

Lamps: 1 x Osram Square EC (LCW CQAR.EC-MQMS-SL7N-35) 273lm @ 250mA CCT=3955K P=2,25W I=250mA

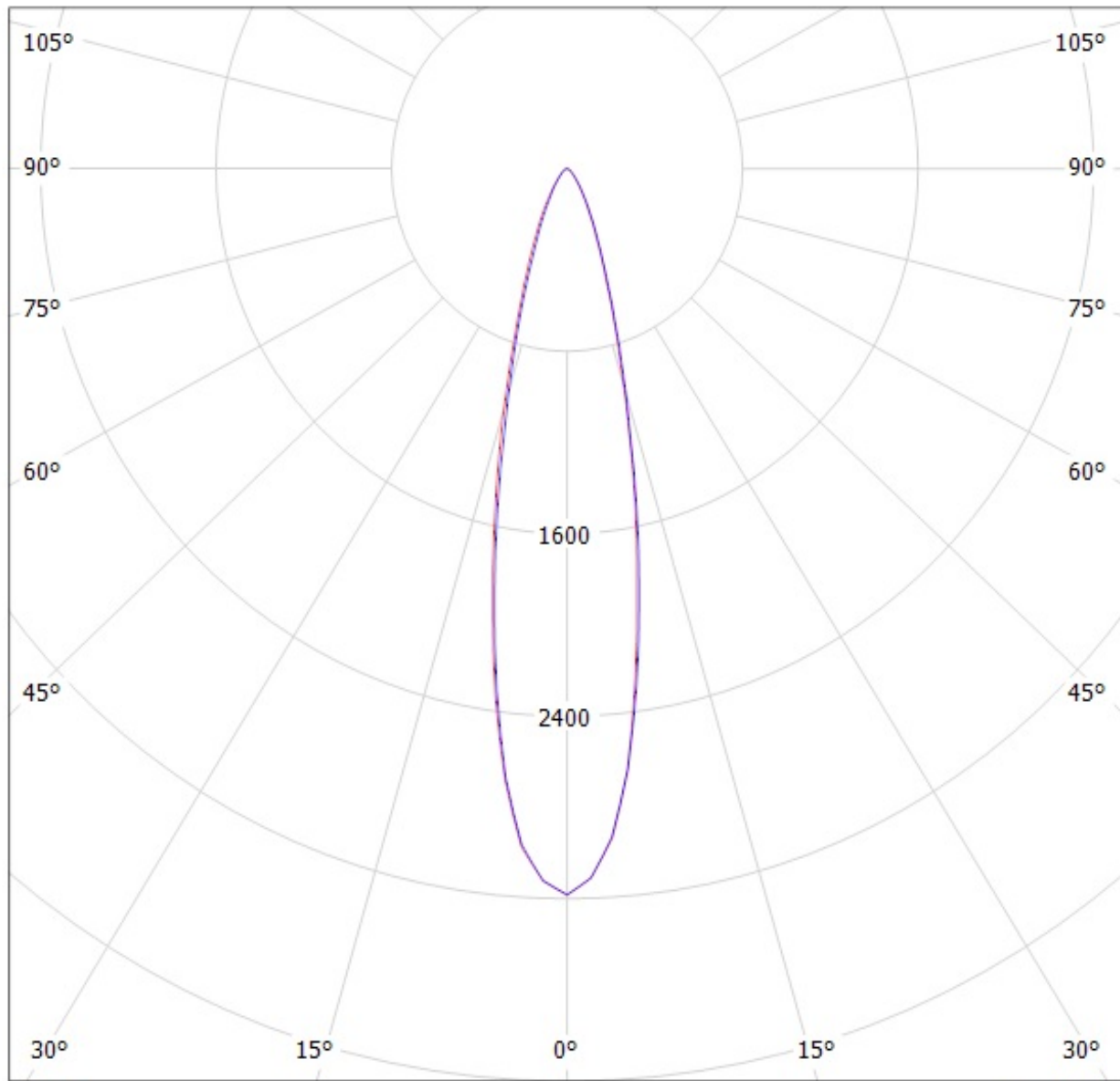

cd/klm

— C0 - C180

— C90 - C270

$\eta = 84\%$

Luminaire: LEDil Oy C13234_SATU-S_(LH351Z)

Lamps: 1 x Samsung LH351Z (234.33lm @ 250mA) CCT=6500K P=2.2W I=250mA

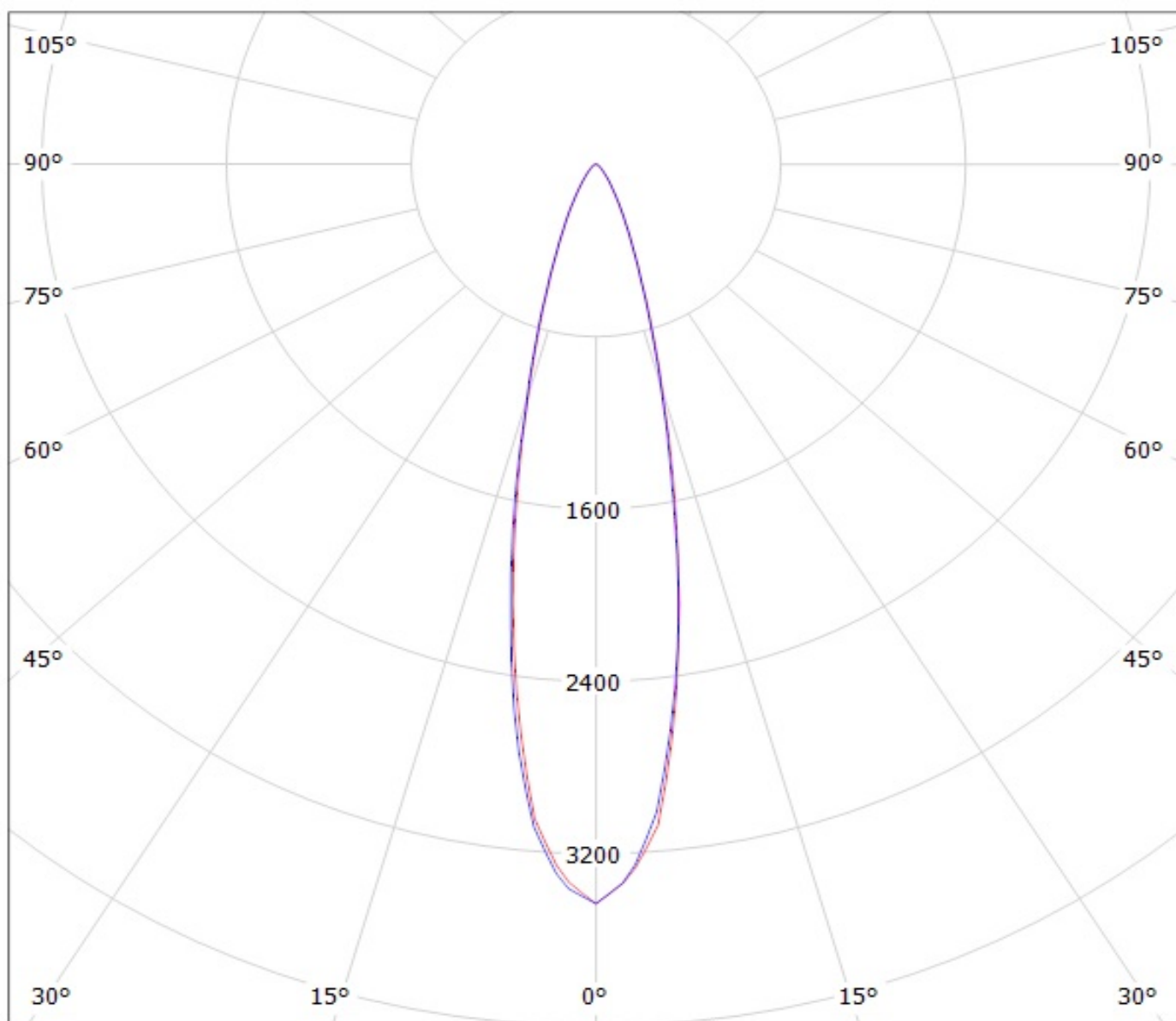

cd/klm

— C0 - C180

— C90 - C270

Luminaire: Ledil Oy C13234_SATU-S_SEOUL_Z8Y22+_SIMULATED
Lamps: 1 x SEOUL Z8Y22 Plus

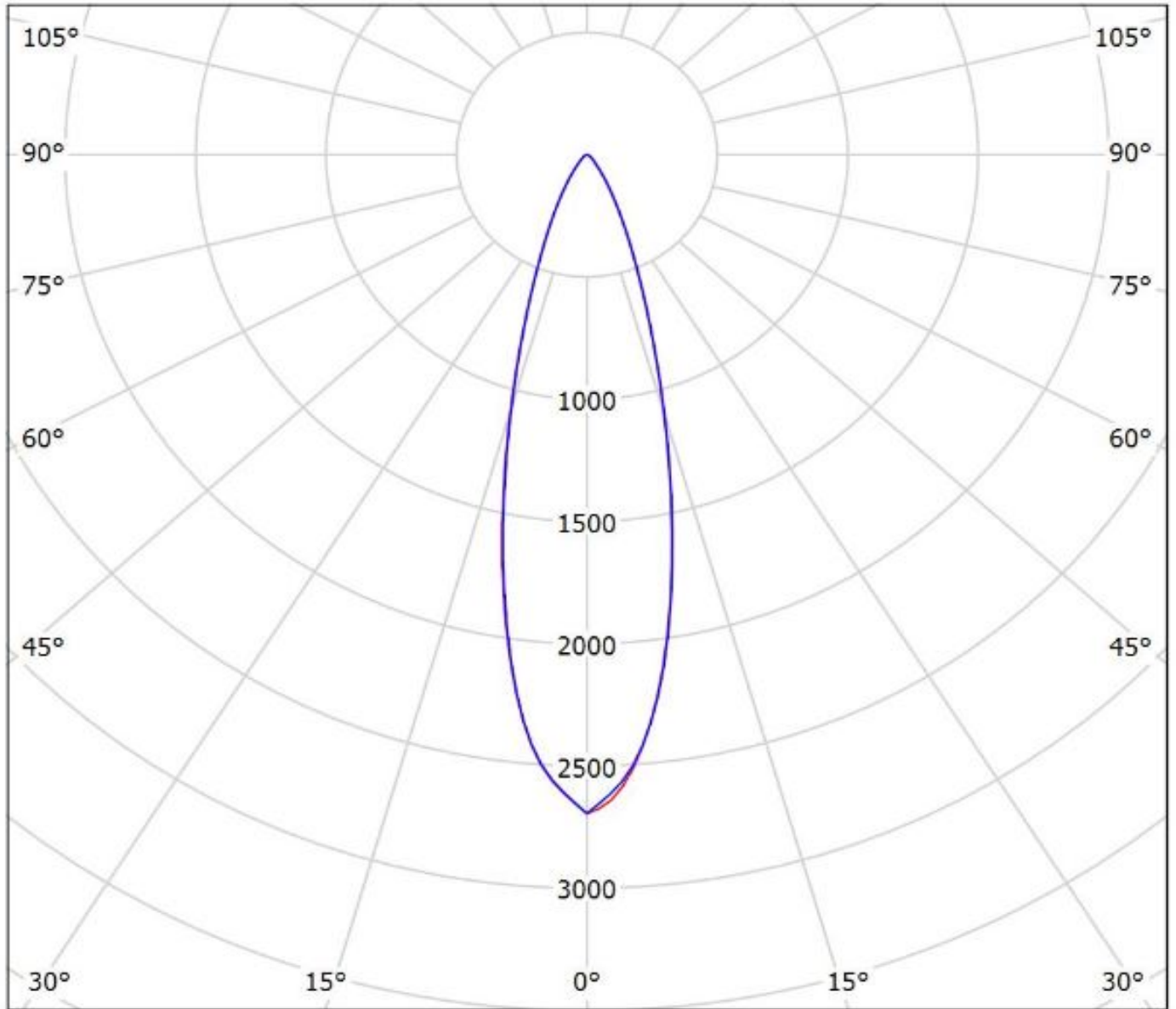

cd/klm

— C0 - C180 — C90 - C270

$\eta = 86\%$

NOTE: The typical divergence will be changed by different color, chip size and chip position tolerance. The typical total divergence is the full angle measured where the luminous intensity is half of the peak value.