

SECTION A-A
(WITH CAP)

SECTION A-A
(WITHOUT CAP)

NOTES:

- MATERIAL:
HOUSING: NYLON, GLASS FILLED, UL94 V-0,
COLOR - SEE TABLE.
CAP: NYLON, GLASS FILLED, UL94V-0
COLOR: BEIGE.
PINS: BRASS ALLOY, C26000, P/N87437-8083.
- PLATING: 2.54µM. MIN. TIN OVER 1.27µM MIN. NICKEL.
- DRAWING SHOWS PLUG WITH 5 CIRCUITS.
- HEADER TO BE USED WITH CRIMP HOUSING, P/N 87439
AND CRIMP TERMINAL, P/N 87421.
- PARTS TO BE PACKED IN MOISTURE BAG.

ADD MOIST BAG NOTE EC NO: S2007-1049 DRWN:SKANG CHKD:ATSEE APPR:MLONG	2007/06/22	QUALITY SYMBOLS ▽=0 ▽C=0	GENERAL TOLERANCES (UNLESS SPECIFIED)		DIMENSION STYLE MM ONLY		SCALE	DESIGN UNITS	THIRD ANGLE PROJECTION	
	2007/06/22		mm	INCH	NTS	METRIC	DRAWN BY DATE KCL ING 1994/04/08			
	2007/06/22		4 PLACES ± --- ± ---	3 PLACES ± --- ± ---	2 PLACES ± 0.20 ± ---	1 PLACE ± --- ± ---	CHECKED BY DATE SKTOH 1994/04/21			
	2007/06/22		ANGULAR ± 3 °		APPROVED BY DATE RWONG 1994/04/21					

DRAFT WHERE APPLICABLE MUST REMAIN WITHIN DIMENSIONS	SIZE	SEE TABLE	
	A3	THIS DRAWING CONTAINS INFORMATION THAT IS PROPRIETARY TO MOLEX INCORPORATED AND SHOULD NOT BE USED WITHOUT WRITTEN PERMISSION	

MATERIAL NO.		DOCUMENT NO.	SHEET NO.
		SD-87437-***31	1 OF 4

TITLE		1.50MM PITCH, W-T-B HEADER, VERTICAL, SMT	
MOLEX INCORPORATED			

10 9 8 7 6 5 4 3 2 1

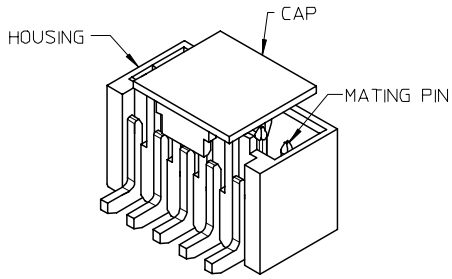

CIRCUIT SIZE	A	B	C	D	E
02	1.50	3.30	3.70	4.30	1.70
03	3.00	4.80	5.20	5.80	3.20
04	4.50	6.30	6.70	7.30	4.70
05	6.00	7.80	8.20	8.80	6.20
06	7.50	9.30	9.70	10.30	7.70
07	9.00	10.80	11.20	11.80	9.20
08	10.50	12.30	12.70	13.30	10.70
09	12.00	13.80	14.20	14.80	12.20
10	13.50	15.30	15.70	16.30	13.70
11	15.00	16.80	17.20	17.80	15.20
12	16.50	18.30	18.70	19.30	16.70
13	18.00	19.80	20.20	20.80	18.20
14	19.50	21.30	21.70	22.30	19.70
15	21.00	22.80	23.20	23.80	21.20

PART NUMBER ASSIGNMENT

87437-XXXX

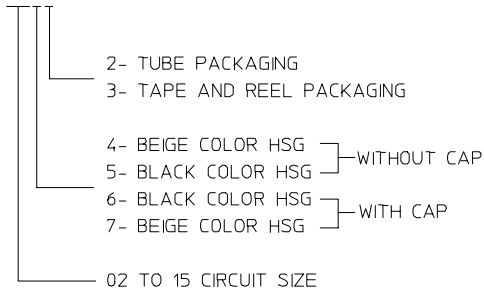

F

E

D

C

B

A

F

E

D

C

B

A

ADD MOIST BAG NOTE EC NO: S2007-1049 DRWN:SKANG CHKD:ATSEE APPR:MLONG	2007/06/22 2007/06/22 2007/06/22	QUALITY SYMBOLS ▽=0 ▽=0	GENERAL TOLERANCES (UNLESS SPECIFIED)		DIMENSION STYLE MM ONLY		SCALE NTS	DESIGN UNITS METRIC	THIRD ANGLE PROJECTION			
			4 PLACES ± --- ± ---	3 PLACES ± --- ± ---	DRAWN BY KCLING	DATE 1994/04/08	TITLE 1.50MM PITCH, W-T-B HEADER, VERTICAL, SMT					
			2 PLACES ± 0.20 ± ---	1 PLACE ± --- ± ---	CHECKED BY SKTOH	DATE 1994/04/21						
			ANGULAR ± 3 °		APPROVED BY RWONG		DATE 1994/04/21	MOLEX INCORPORATED				
		DRAFT WHERE APPLICABLE MUST REMAIN WITHIN DIMENSIONS		MATERIAL NO. SEE TABLE		DOCUMENT NO. SD-87437-**31	SHEET NO. 2 OF 4					

9 8 7 6 5 4 3 2 1

10 9 8 7 6 5 4 3 2 1

EMBOSSED CARRIER TAPE PACKING DETAILS FOR PARTS WITHOUT CAP

F
E
D
C
B
A

F
E
D
C
B
A

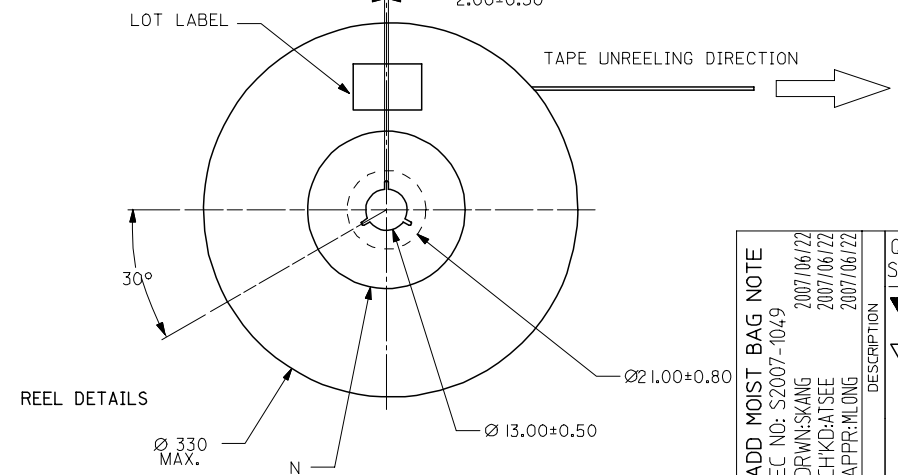
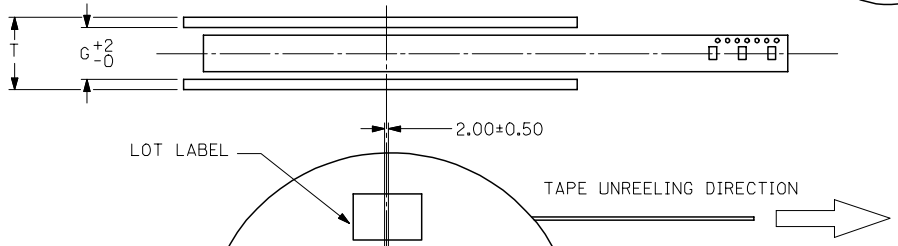
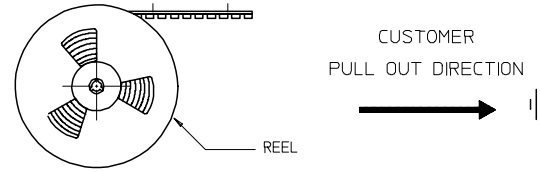
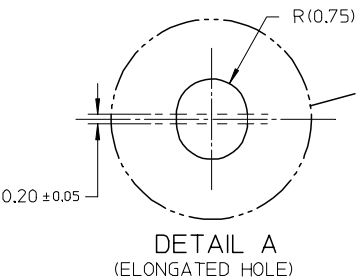
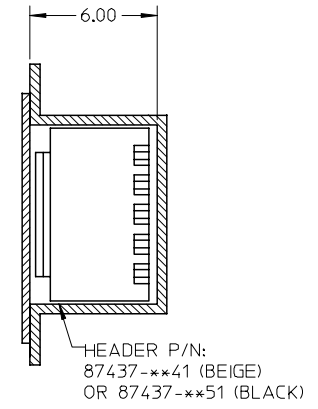
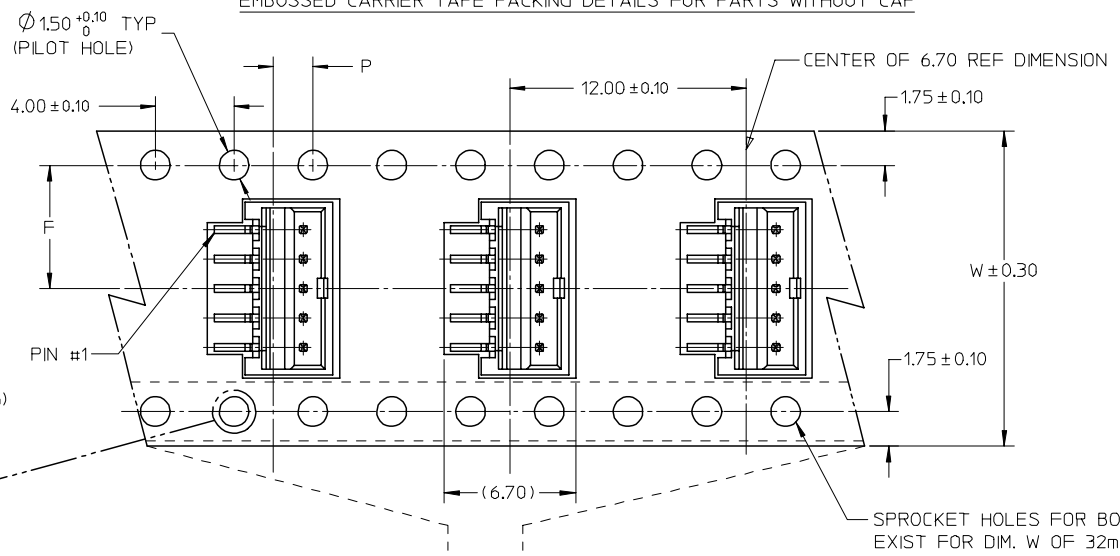

ADD MOIST BAG NOTE	DESCRIPTION
EC NO: S2007-1049	REV
DRWN:SKANG	2007/06/22
CHKD:ATSEE	2007/06/22
APPR:MLONG	2007/06/22
D7	

QUALITY SYMBOLS	▽=0
	∇=0

GENERAL TOLERANCES (UNLESS SPECIFIED)	mm	INCH
	4 PLACES ± ---	± ---
	3 PLACES ± ---	± ---
	2 PLACES ± 0.20	± ---
	1 PLACE ± ---	± ---
	ANGULAR ± 3 °	
DRAFT WHERE APPLICABLE MUST REMAIN WITHIN DIMENSIONS		

DIMENSION STYLE		SCALE	DESIGN UNITS	THIRD ANGLE PROJECTION
MM ONLY		NTS	METRIC	
DRAWN BY	DATE	TITLE		
KCLING	1994/04/08	1.50MM PITCH, W-T-B HEADER, VERTICAL, SMT		
CHECKED BY	DATE			
SKTOH	1994/04/21			
APPROVED BY	DATE			
RWONG	1994/04/21			
MATERIAL NO.	DOCUMENT NO.			
SEE TABLE	SD-87437-**31			
SIZE	THIS DRAWING CONTAINS INFORMATION THAT IS PROPRIETARY TO MOLEX INCORPORATED AND SHOULD NOT BE USED WITHOUT WRITTEN PERMISSION			
A3				

MOLEX INCORPORATED		SHEET NO.
		3 OF 4

9 8 7 6 5 4 3 2 1

EMBOSSED CARRIER TAPE PACKING DETAILS FOR PARTS WITH CAP

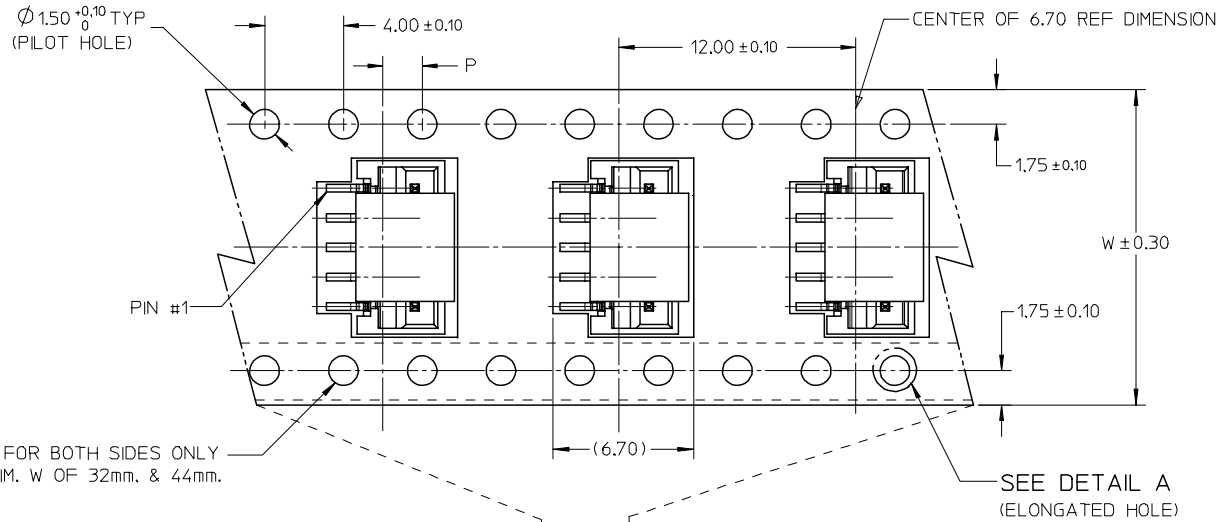

NOTES:

1. LEADER AND TRAILER TAPE

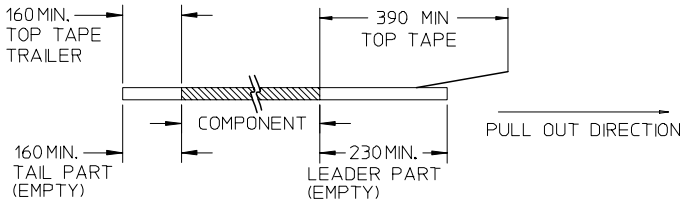

2. PEELING OFF FORCE OF THE TOP TAPE: 20-80gf.
(PEELING DIRECTION AS SHOWN IN FOLLOWING FIGURE)

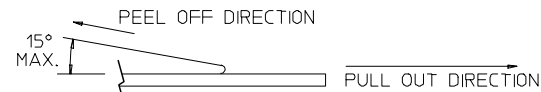

- 3. THE TAPE IS TREATED FOR ANTI-STATIC.
- 4. PACKAGING STANDARD IS AS PER EIA-481.
- 5. TAPE & REEL QUANTITY = 1000PCS/REEL (WITHOUT CAP)
TAPE & REEL QUANTITY = 900PCS/REEL (WITH CAP)

15	44	20.20±0.15	100	44.40	50.40	2.00±0.15
11, 12, 13, 14	32	14.20±0.10	100	32.40	38.40	2.00±0.10
7, 8, 9, 10	24	11.50±0.10	100	24.40	30.40	2.00±0.10
2, 3, 4, 5, 6	16	7.50±0.10	100	16.40	22.40	2.00±0.10
CIRCUIT SIZE	W	F	N	G	T MAX	P

ADD MOIST BAG NOTE EC NO: S2007-1049 DRWNS:KANG CHKD:ATSEE APPR:MLONG	2007/06/22 2007/06/22 2007/06/22	QUALITY SYMBOLS ▽=0 ▽=0	GENERAL TOLERANCES (UNLESS SPECIFIED)		DIMENSION STYLE MM ONLY		SCALE NTS	DESIGN UNITS METRIC	THIRD ANGLE PROJECTION	
					DRAWN BY KCLING		DATE 1994/04/08	TITLE 1.50MM PITCH, W-T-B HEADER, VERTICAL, SMT		
			4 PLACES ± --- ± ---		CHECKED BY		DATE	MOLEX INCORPORATED SD-87437-**-31		
			3 PLACES ± --- ± ---		SKTOH		DATE			
2 PLACES ± 0.20 ± ---		APPROVED BY RWONG		DATE 1994/04/21	MATERIAL NO.		DOCUMENT NO.	SHEET NO.		
1 PLACE ± --- ± ---		ANGULAR ± 3 °		SEE TABLE		SD-87437-**-31		4 OF 4		
DRAFT WHERE APPLICABLE MUST REMAIN WITHIN DIMENSIONS		SIZE A3		THIS DRAWING CONTAINS INFORMATION THAT IS PROPRIETARY TO MOLEX INCORPORATED AND SHOULD NOT BE USED WITHOUT WRITTEN PERMISSION						